



Chipsmall Limited consists of a professional team with an average of over 10 year of expertise in the distribution of electronic components. Based in Hongkong, we have already established firm and mutual-benefit business relationships with customers from,Europe,America and south Asia,supplying obsolete and hard-to-find components to meet their specific needs.

With the principle of “Quality Parts,Customers Priority,Honest Operation,and Considerate Service”,our business mainly focus on the distribution of electronic components. Line cards we deal with include Microchip,ALPS,ROHM,Xilinx,Pulse,ON,Everlight and Freescale. Main products comprise IC,Modules,Potentiometer,IC Socket,Relay,Connector.Our parts cover such applications as commercial,industrial, and automotives areas.

We are looking forward to setting up business relationship with you and hope to provide you with the best service and solution. Let us make a better world for our industry!



Contact us

Tel: +86-755-8981 8866 Fax: +86-755-8427 6832

Email & Skype: info@chipsmall.com Web: www.chipsmall.com

Address: A1208, Overseas Decoration Building, #122 Zhenhua RD., Futian, Shenzhen, China



XL-TrashSonar™ -WR™ Series

IP67 Weather Resistant, Ultrasonic Trash Sensor

MB7137, MB7138, MB7139³

The XL-TrashSonar-WR sensor series provide users with robust range information in air. These sensors also feature high-power acoustic output along with real-time auto calibration for changing conditions (supply voltage sag, acoustic noise, or electrical noise), operation with supply voltage from 3.0V to 5.5V, object detection from 0-cm to 350-cm, and sonar range information from 20-cm out to 350-cm with 1-cm resolution. Objects from 0-cm to 20-cm typically range as 20-cm. (25cm for the MB7138²) The sensor is housed in a robust PVC housing, designed to meet the IP67 water intrusion standard. This sensor line is available in the following package types — 3/4" PVC threading, 1" NPS pipe threading, 1" BSPP pipe threading, and 30mm 1.5 pipe threading.

The user interface formats included are pulse-width, analog voltage output, RS232 serial output, and I2C (MB7137).



Features

- Real-time auto calibration and noise rejection
- High acoustic power output
- Precise narrow beam
- Object detection includes zero range objects
- 3V to 5.5V supply with very low average current draw
- Free run operation can continually measure and output range information
- Triggered operation provides the range reading as desired
- All interfaces are active simultaneously
- RS232 Serial, 0 to Vcc, 9600 Baud, 81N (MB7138, MB7139)
- I2C Bus operates up to 400KHz with clock stretching (MB7137)
- Analog, (Vcc/1024) / cm (MB7138, MB7139)
- Sensor operates at 42KHz

Benefits

- Acoustic and electric noise resistance
- Reliable and stable range data
- Robust, low cost IP67 standard sensor
- Narrow beam characteristics
- Very low power excellent for battery based systems
- Ranging can be triggered externally or internally
- Sensor reports the range reading directly, frees up user processor
- Easy hole mounting or mating with standard electrical fittings
- Filtering allows very reliable operation in most environments

Applications & Uses

- Tank level measurement
- Bin level measurement
- Trash level measurement
- Environments with acoustic and electrical noise
- Distance measuring
- Long range object detection
- Industrial sensor
- -40°C to +65°C operation¹

Notes:

¹Please reference page 15 for minimum operating voltage verses temperature information.

²Minimum distance is 25cm for the MB7138

³Please reference page 20 for part number key.

Close Range Operation

Applications requiring 100% reading-to-reading reliability should not use MaxSonar sensors at a distance closer than 20cm. Although most users find MaxSonar sensors to work reliably from 0 to 20cm for detecting objects in many applications, MaxBotix™ Inc. does not guarantee operational reliability for objects closer than the minimum reported distance. Because of ultrasonic physics, these sensors are unable to achieve 100% reliability at close distances.

25cm for the MB7138²

Warning: Personal Safety Applications

We do not recommend or endorse this product be used as a component in any personal safety applications. This product is not designed, intended or authorized for such use. These sensors and controls do not include the self-checking redundant circuitry needed for such use. Such unauthorized use may create a failure of the MaxBotix™ Inc. product which may result in personal injury or death. MaxBotix™ Inc. will not be held liable for unauthorized use of this component.

MB7137 Pinout

For I2C information please skip to page 12

Pin 1 - Temporary Default: This pin is internally pulled high. On power up, the state of this pin is checked. If the pin is left high or disconnected the sensor will use the address stored in memory for I2C communication. If pulled low, the sensor will use its default address for the current power cycle.

Pin 2 - Address Announce / Status: While the sensor is performing a range reading. During non-ranging operation, this pin is held low and the sensor is listening for incoming I2C communication. Operationally, users may poll this pin to determine if the sensor has finished its ranging cycle and is ready to report the latest range information.

During power-up this pin will provide a pulse width representation of the sensor's current address with a length of ~100 microseconds per digit. (The default address of 224 will announce with a pulse of 22,400 microseconds in length)

Pin 3 - Not Used: This pin is not used.

Pin 4 - SDA (I2C Data): This is the data line for I2C communications. These sensors operate as I2C slave devices.

Pin 5 - SCL (I2C Clock): This is the clock line for I2C communications. These sensors support I2C clock frequencies up to 400KHz provided clock stretching is supported by the master devices. Without clock stretching the devices can run at speeds up to 50KHz.

V+ Operates on 3V - 5.5V. The average (and peak) current draw for 3.3V operation is 2.7mA (50mA peak) and 5V operation is 4.4mA (100mA peak) respectively. Peak current is used during sonar pulse transmit. Please reference page 15 for minimum operating voltage verses temperature information.

GND: Return for the DC power supply. GND (& V+) must be ripple and noise free for best operation.

MB7138 & MB7139 Pinout

Pin 1 - BW: Leave open (or high) for serial output on the Pin 5 output. When Pin 1 is held low the Pin 5 output sends a pulse (instead of serial data), suitable for low noise chaining.

Pin 2 - PW: This pin outputs a pulse-width representation of range. To calculate the distance, use a scale factor of 58uS per cm.

Pin 3 - AN: This pin outputs analog voltage with a scaling factor of (Vcc/1024) per cm. A supply of 5V yields ~4.9mV/cm., and 3.3V yields ~3.2mV/cm. The output is buffered and corresponds to the most recent range data.

Pin 4 - RX: This pin is internally pulled high. If Pin-4 is left unconnected or held high, the sensor will continually measure the range. If Pin-4 is held low the sensor will stop ranging. Bring high 20uS or more to command a range reading.

Pin 5 - TX: When Pin 1 is open or held high, the Pin 5 output delivers asynchronous serial data in an RS232 format, except the voltages are 0-Vcc. The output is an ASCII capital "R", followed by ASCII character digits representing the range in centimeters up to a maximum of 350, followed by a carriage return (ASCII 13). The baud rate is 9600, 8 bits, no parity, with one stop bit. Although the voltages of 0V to Vcc are outside the RS232 standard, most RS232 devices have sufficient margin to read the 0V to Vcc serial data. If standard voltage level RS232 is desired, invert, and connect an RS232 converter such as a MAX232. When Pin 1 is held low, the Pin 5 output sends a single pulse, suitable for low noise chaining (no serial data).

V+ Operates on 3V - 5.5V. The average (and peak) current draw for 3.3V operation is 2.1mA (50mA peak) and 5V operation is 3.4mA (100mA peak) respectively. Peak current is used during sonar pulse transmit. Please reference page 15 for minimum operating voltage verses temperature information.

GND-Return for the DC power supply. GND (& V+) must be ripple and noise free for best operation.

About Ultrasonic Sensors

Our ultrasonic sensors are designed for use in air, non-contact object detection and ranging sensors that detect objects within a defined area. These sensors are not affected by the color or other visual characteristics of the detected object. Ultrasonic sensors use high frequency sound to detect and localize objects in a variety of environments. Ultrasonic sensors measure the time of flight for sound that has been transmitted to and reflected back from nearby objects. Based upon the time of flight, the sensor then outputs a range reading.

Supply Voltage Compensation

During power up, the XL-TrashSonar-WR sensor line will calibrate itself for the supply voltage. Additionally, the sensor will compensate if the supplied voltage gradually changes.

If the average voltage applied to the sensor changes faster than 0.5V per second, it is best to remove and reapply power to the sensor.

For best operation, the sensor requires noise free power. If the sensor is used with noise on the supplied power or ground, the accuracy of the readings may be affected. Typically, adding a 100uF capacitor at the sensor between the V+ and GND pins will correct most power related electrical noise issues.

MB7139

The MB7139 is the base model of the XL-TrashSonar-WR sensor line. This sensor is recommended for general purpose use. The additional features are mentioned below.

The MB7139 reports the range to the first detectable target. Unless the target is barely detectable, this sensor will have a very stable output. If a smaller object is in front of the target, the sensor may report the range to the object depending on the object's size and position.

MB7137

The MB7137 communicates using the I2C bus protocol. This sensor reports the range to the first detectable target in real-time. This sensor is capable of outputting new range readings with speeds up to 40Hz if the status pin is being monitored. The recommended refresh rate is 10Hz or slower.

MB7138

The XL-TrashSonar-WRM sensors prioritize large targets over both small targets and noise. These sensors report the target that gives the largest acoustic reflection. This stands in contrast to other units such as the MB7139 which are designed to report the distance to the first detectable target. If the largest target is removed from the field of view, the MB7138 will switch to the target that gives the next largest detectable return. ^{25cm for the MB7138²}

The XL-TrashSonar-WRM sensors are designed for applications where users are concerned with ranging the distance to flat targets (such as water and fuel tanks).

When targets are of similar amplitude reflections, preference is given to the closer target. The sensor expects to see a target by 3.5 meters. If no target is found, the sensor will increase in sensitivity until a target is found, or until no targets can be found.

In addition to the most-likely filtering, the MB7052 and MB7092 come equipped with a three-reading filter and reading hold which requires three consecutive range readings within 1cm of the most recent reading to be considered a valid range reading. If readings are found to be outside 1cm, or no target can be found by the sensor, then the sensor will report the last valid range reading. Upon power-up the sensor will default to reporting 3.5 meters unit a valid range reading is found.

The last reading hold is designed for users operating in environments with intermittent high noise who desire to poll the MB7138 at intermittent times. This allows the sensor to report the previously valid reading until the sensor's environment improves. If no valid range reading is found for ~1.5 hours, the sensor will send a fail-safe output "000" on all interfaces.

Sensor Integration

The XL-TrashSonar-WR sensors are designed to be mounted at the top of a trash receptacle near the center. For best operation, it is recommended that end users conduct filtering of the sensor data to achieve the most reliable results.

Filtering Examples

- History Filter — Verifies the reading is accurate when compared to the previous ranges.
- Mode Filter — Output the sensor's reported range that is shown the most.
- Median filter — Output the reported range that is in the center of a range set.

Sensor Mounting

Trash bins that are lined with plastic bags may detect false reflections if there is air trapped behind the plastic bag.

If the sensor is mounted in a trash bin with stepping sides that get narrower from top down, shown in Diagram 1, the sensor will typically not range properly to the trash. In this installation the sensor may report the range to the highest side step.

For trash bins with internal side braces, shown in Diagram 2, the sensor will not report the range past the internal brace. Like the side steps, this brace creates an ultrasonic echo that the sensor may report the range to.

For installations with that get wider from the top of the bin to the base, shown in Diagram 3, the sensor will typically report the trash level properly. Testing is recommended for this configuration if side steps get dramatically wider as they may be detected by the XL-TrashSonar-WR.

Diagram 4 shows the ideal sensor mounting for the XL-TrashSonar-WR sensor line. It is recommended that the sensor is mounted in a trash bin with smooth sides. This either eliminates or dramatically reduces the secondary reflections that may return to the sensor.

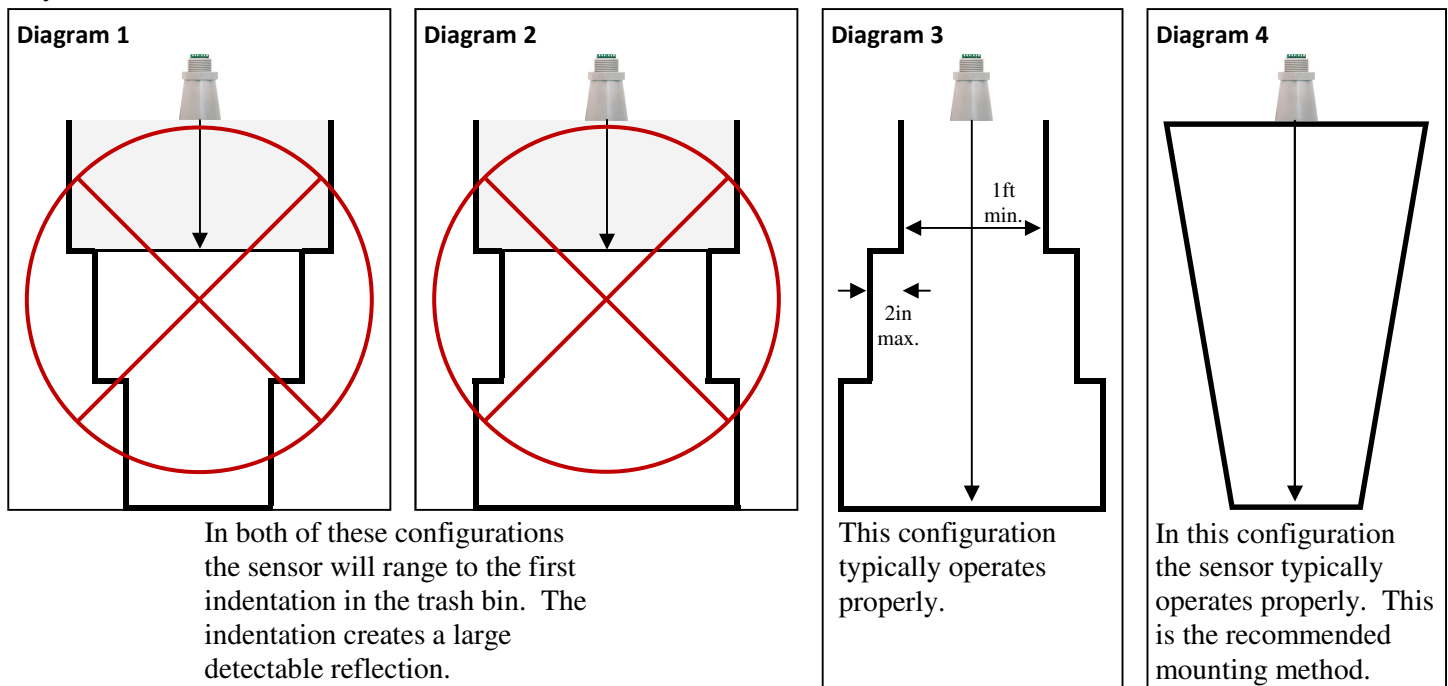

As the bin increases in size, the less likely the installation is going to detect unwanted objects and noise.

Testing is recommended for any sensor mounting method and bin size.

Sensor Minimum Distance

The XL-TrashSonar-WR sensors have a minimum reported distance of 20-cm (7.87 inches). However, the XL-TrashSonar-WR will range and report targets to the front sensor face. Large targets closer than 20-cm will typically range as 20-cm. For the alternative housings, objects between 4-cm and 20-cm will typically range as 20-cm.

About Package Types

The XL-TrashSonar-WR sensor line is available in a variety of packages for applications with specific mounting requirements. The full horn package provides peak accuracy and sensitivity in this sensor line. It is recommended that testing is completed to ensure that the selected sensor will operate as desired in your application.

Package Types Currently Available
Full Horn — 3/4" NPT straight; back mounted thread (best performance)
Compact — 3/4" NPT straight; back mounted thread
Ultra-Compact — PCB with 4 mounting holes
1"NPS — External thread over full sensor body (1"NPS)
1" BSPP — External thread over full sensor body (1"BSPP)
30mm1.5 — External thread over full sensor body (30mm1.5)
All package types have exposed PCB on user end for easy connection. Users desiring a fully enclosed assembly may purchase the "Shielded Cable Attach Option" along with their sensor.



Performance Changes when Selecting a Non-Full Horn Package

When selecting a XL-TrashSonar-WR without the full horn the sensor will experience the following performance changes:

- The sensor will have a wider beam shape for the first meter.
- The sensor may have a dead zone from 0-6cm.
- The sensor may have worse performance to small or soft targets.
- The sensor may experience decreased noise immunity when ranging to small, soft, angled, or distant targets.

Mechanical Dimensions

Full Horn

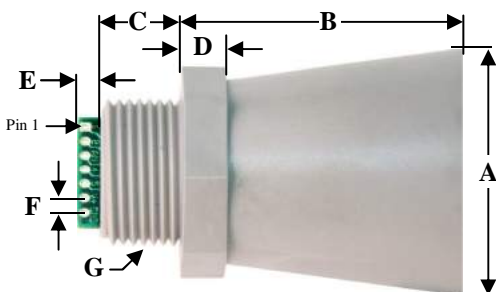

A	1.72" dia.	43.8 mm dia.
B	2.00"	50.7 mm
C	0.58"	14.4 mm
D	0.31"	7.9 mm
E	0.23"	5.8 mm
F	0.10"	2.54 mm
G	3/4"-14 NPS	
H	1.032" dia.	26.2 mm dia.
I	1.37"	34.8 mm
	Weight	50 grams



Values Are Nominal

Mechanical Dimensions Continued

Ultra-Compact

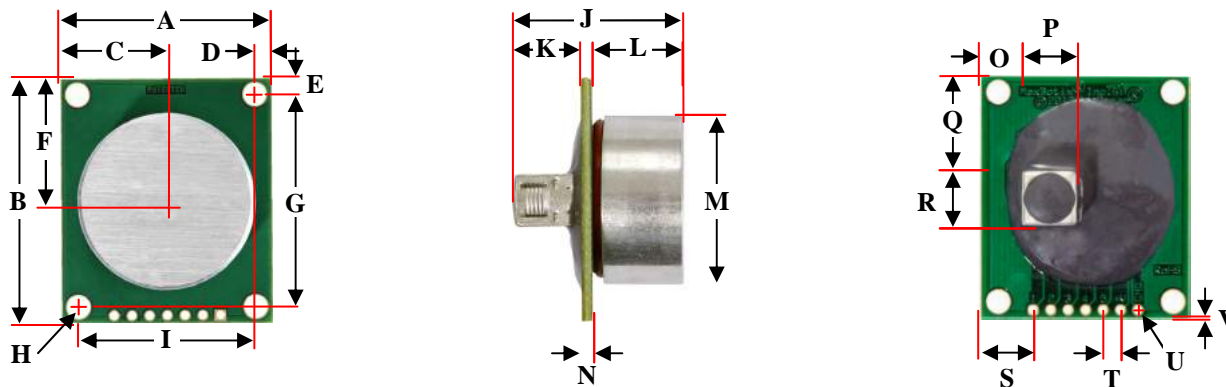

All values are nominal		
A	30.48 mm	1.20"
B	35.56 mm	1.40"
C	12.24 mm	0.60"
D	2.54 mm	0.10"
E	2.54 mm	0.10"

F	17.78 mm	0.70"
G	30.48 mm	1.20"
H	3.18 mm	0.13"
I	25.4 mm	1.00"
J	25.27 mm	1.00"
K	10.4 mm	0.41"

L	13.4 mm	0.53"
M	25.0 mm	0.98"
N	1.57 mm	0.62"
O	6.2 mm	0.24"
P	8.0 mm	0.31"
Q	13.9 mm	0.55"

R	7.80 mm	0.31"
S	7.62 mm	0.30"
T	2.54 mm	0.10"
U	1.07 mm	0.04"
V	1.27 mm	0.05"
Weight 15.1 gram.		

Compact Housing

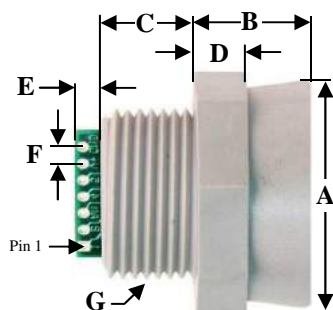

A	1.37" dia.	34.7 mm dia.
B	0.70"	17.9 mm
C	0.57"	14.4 mm
D	0.31"	7.9 mm
E	0.23"	5.8 mm
F	0.10"	2.54 mm
G	3/4"-14 NPS	
H	1.032" dia.	26.2 mm dia.
I	1.37"	34.8 mm
Weight		32 grams

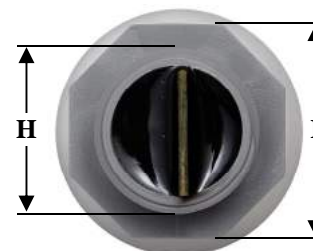

Values Are Nominal

1" NPS Pipe Threading

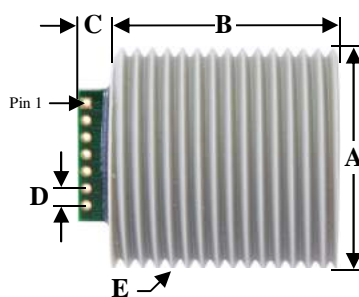

A	1.29" dia.	38.2 mm dia.
B	1.30"	33.1 mm
C	0.20"	5.2 mm
D	0.10"	2.54 mm
E	1" — NPS	
F	0.78"	19.8 mm
Weight		35 grams

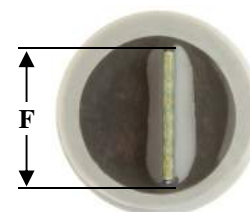

Values Are Nominal

Mechanical Dimensions Continued

1" BSPP Pipe Threading

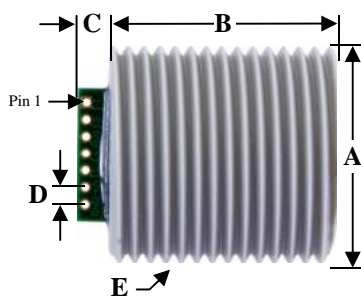

A	1.29" dia.	38.2 mm dia.
B	1.30"	33.1 mm
C	0.20"	5.2 mm
D	0.10"	2.54 mm
E	1" — BSPP	
F	0.78"	19.8 mm
Weight		34 grams

Values Are Nominal

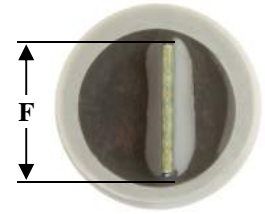

30mm1.5 Pipe Threading

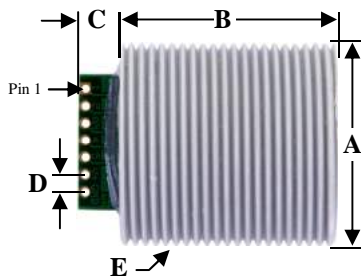

A	1.17" dia.	29.7 mm dia.
B	1.30"	33.1 mm
C	0.20"	5.2 mm
D	0.10"	2.54 mm
E	30mm 1.5	
F	0.78"	19.8 mm
Weight		31 grams

Values Are Nominal



Device Comparison Chart

Part Number	AN Voltage	Serial Data (0 to Vcc level)	Pulse Width	I2C Bus	Stability Filter	Most Likely Filter
MB7137				Yes		
MB7138	Yes	RS232	Yes		Yes	Yes
MB7139	Yes	RS232	Yes			

Real-time Auto Calibration

The XL-TrashSonar-WR automatically calibrates prior to each range reading. The sensor then uses this data to range objects. If the temperature, humidity, or applied voltage changes during sensor operation, the sensor will continue to function normally. (The sensors do not apply compensation for the speed of sound change verses temperature to any range readings.) Detection has been characterized in the published sensor beam patterns.

Real-Time Noise Rejection

While the XL-TrashSonar-WR is designed to operate in the presence of noise, best operation is obtained when noise strength is low and desired signal strength is high. Hence, the user is encouraged to mount the sensor in such a way that minimizes outside acoustic noise pickup. In addition, keep the DC power to the sensor free of noise. This will let the sensor deal with noise issues outside of the users direct control (Even so, in general, the sensor will still function well even if these things are ignored). Users are encouraged to test the sensor in their application to verify usability.

Temperature Compensation

The speed of sound in air increases about 0.6 meters per second, per degree centigrade. The XL-TrashSonar-WR sensors are not equipped with an internal temperature compensation. If temperature compensation is desired, it is recommended to test an HRXL-MaxSonar-WR. The HRXL-MaxSonar-WR applies compensation for speed of sound changes.

Range "0" Location

The XL-TrashSonar-WR will report the range to the closest detectable object. Target detection has been characterized in the sensor beam patterns.

The XL-TrashSonar-WR sensors reports the range to distant targets starting from the front of the sensor as shown in the diagrams below.

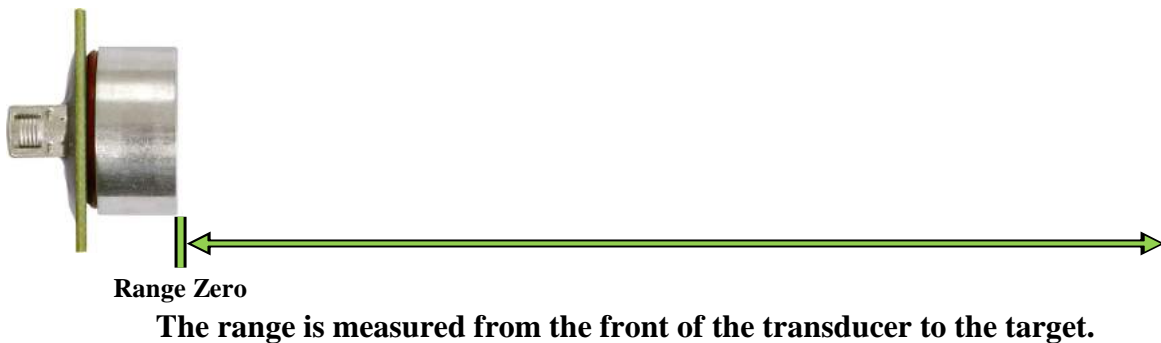
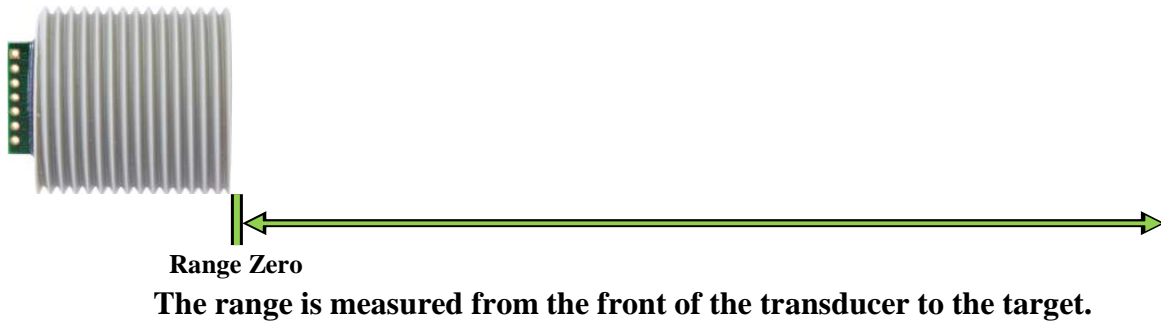
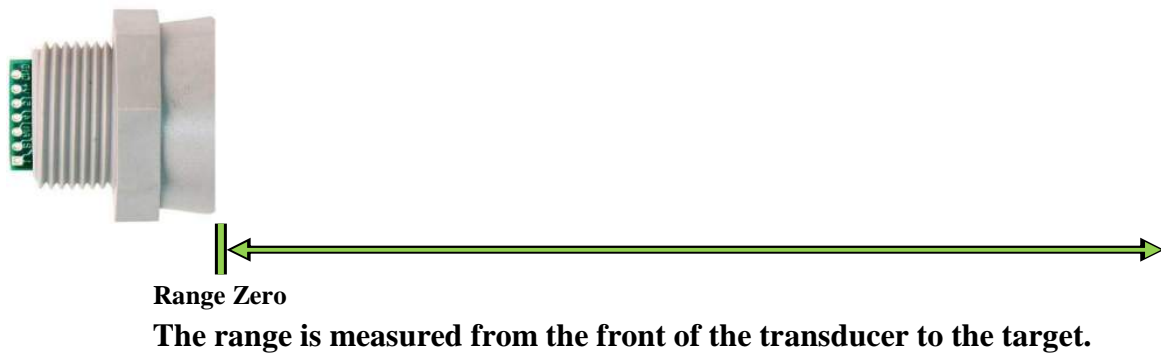
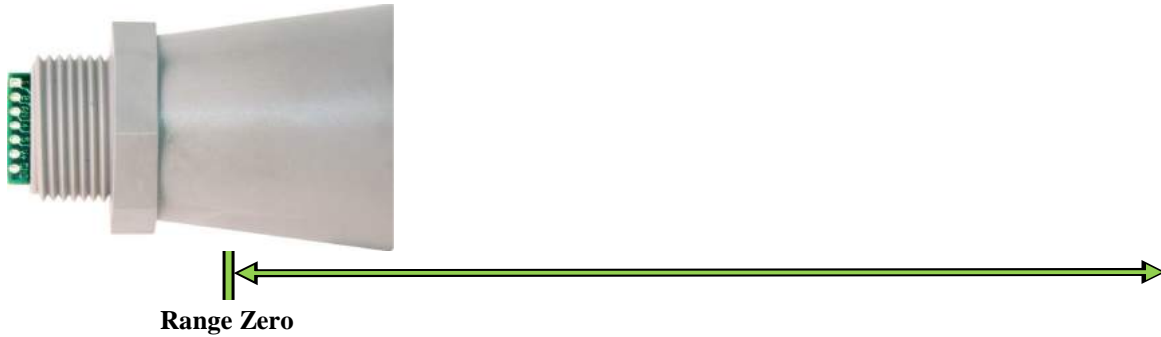

MB7138 - MB7139 Operating Modes

Independent Sensor Operation

The XL-TrashSonar-WR sensors are designed to operate in a single sensor environment. Free-run is the default mode of operation for all of the MaxBotix Inc., sensors. The XL-TrashSonar-WR sensors have three separate outputs that update the range data simultaneously: Analog Voltage, Pulse Width¹, and RS232 Serial. Below are diagrams on how to connect the sensor for each of the three outputs.

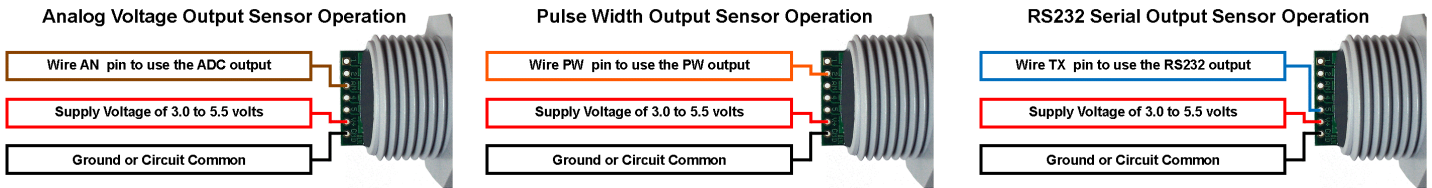

Using Multiple Sensors in a Single System

When using multiple ultrasonic sensors in a single system, there can be interference (cross-talk) from the other sensors. MaxBotix Inc., has engineered a solution to this problem for the XL-TrashSonar-WR sensors. The solution is referred to as chaining. We have 3 methods of chaining that work well to avoid the issue of cross-talk.

The first method is AN Output Commanded Loop. The first sensor will range, then trigger the next sensor to range and so on for all the sensors in the array. Once the last sensor has ranged, the array stops until the first sensor is triggered to range again. Below is a diagram on how to set this up.

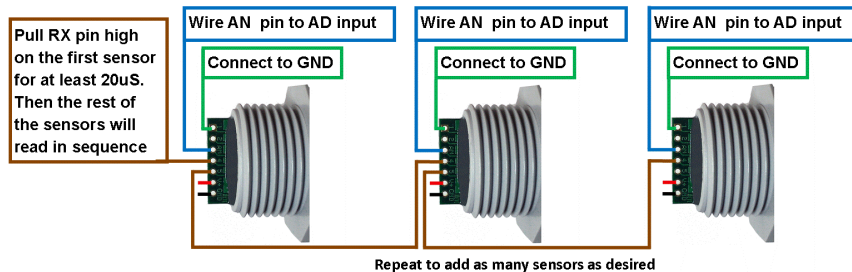

The next method is AN Output Constantly Looping. The first sensor will range, then trigger the next sensor to range and so on for all the sensor in the array. Once the last sensor has ranged, it will trigger the first sensor in the array to range again and will continue this loop indefinitely. Below is a diagram on how to set this up.

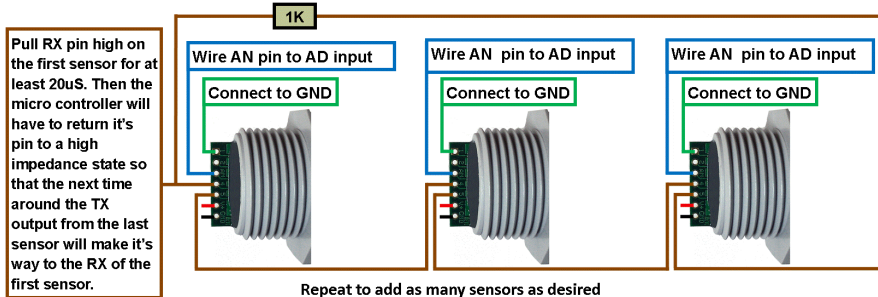

The final method is AN Output Simultaneous Operation. This method does not work in all applications and is sensitive to how the other sensors in the array are physically positioned in comparison to each other. Testing is recommend to verify this method will work for your application. All the sensors RX pins are connected together and triggered at the same time causing all the sensor to take a range reading at the same time. Once the range reading is complete, the sensors stop ranging until triggered next time. Below is a diagram on how to set this up.

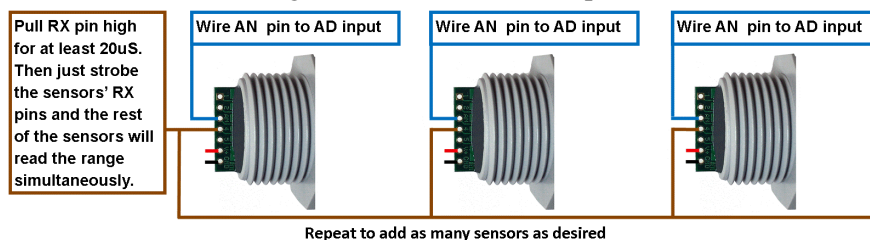

MB7138 - MB7139 Sensor Timing Diagrams

Power-Up Timing

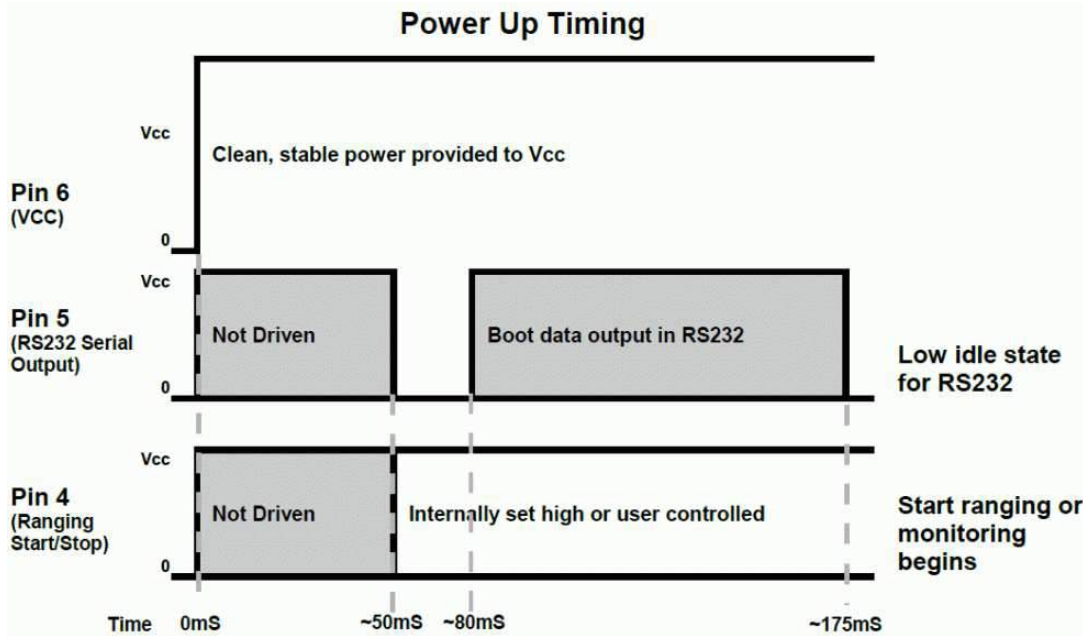

Sensor Free-Run Timing

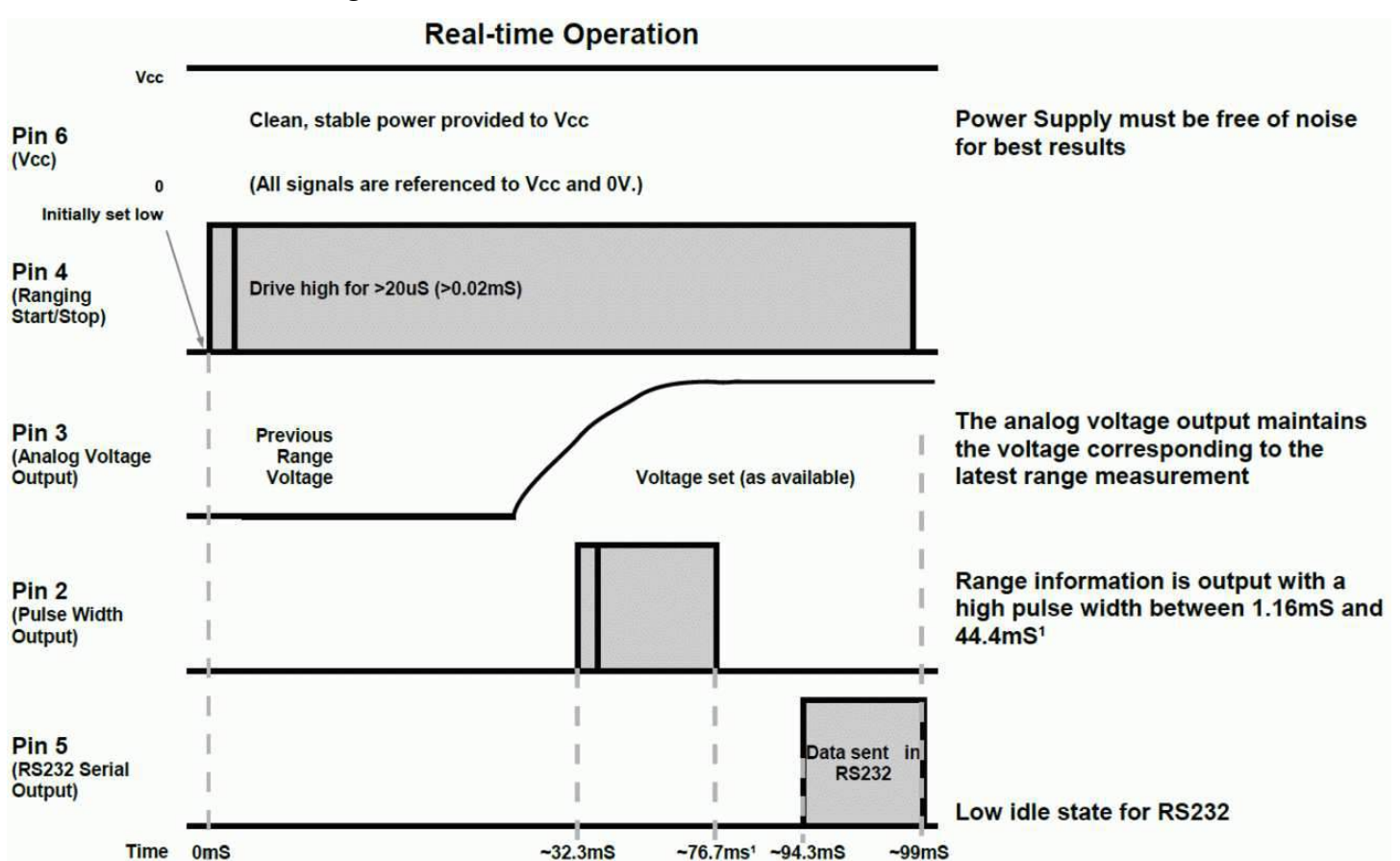

MB7138 - MB7139 Sensor Timing Diagrams Continued

Real-Time Operation

Free-Run Operation

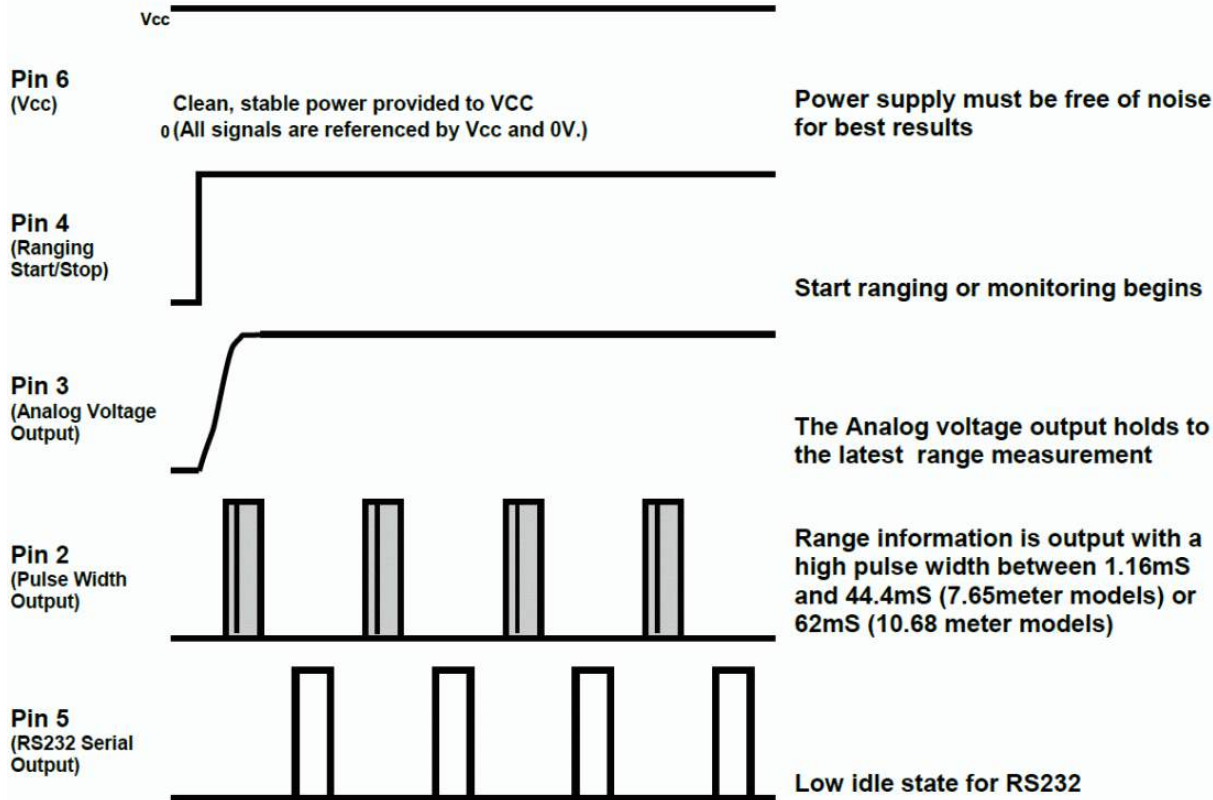

Timing Description

175mS after power-up, the XL-TrashSonar-WR is ready to begin ranging. If Pin-4 is left open or held high (20uS or greater), the sensor will take a range reading. The XL-TrashSonar-WR checks Pin-4 at the end of every cycle. Range data can be acquired once every range reading. Each range reading starts by Pin-4 being high or open, after which the XL-TrashSonar-WR calibrates and calculates for 20.5mS, and after which, thirteen 42KHz waves are sent. The sensor then determines the range to the target. Next the analog voltage is set. At 99mS, the sensors with a pulse width (PW), Pin 2 is set high for a length of time between 1.16mS and 20.3mS. At 94.3mS, for the next 4.7mS the serial data is sent. The most accurate range output on the XL-TrashSonar-WR sensors is the PW output.

MB7137 Default Address

The representation of the sensor address will be different depending on the addressing scheme your master device uses. The chart below shows the default address for the I2CXL-MaxSonar-WR/WRC sensors under different addressing implementations. Elsewhere in this datasheet a 8-bit read/write addressing scheme is assumed.

Addressing	Default Address	Default Address	Notes
7-bit addressing	112	1110 000X	7-bit addressing handles the address shifting and R/W bit for the user
8-bit addressing	224	1110 000X	8-bit addressing inserts the R/W bit and only allows for even number addresses
8-bit read/write addressing	Write: 224 Read: 225	1110 0000 1110 0001	8-bit R/W addressing schemes require the user to set the R/W bit directly.

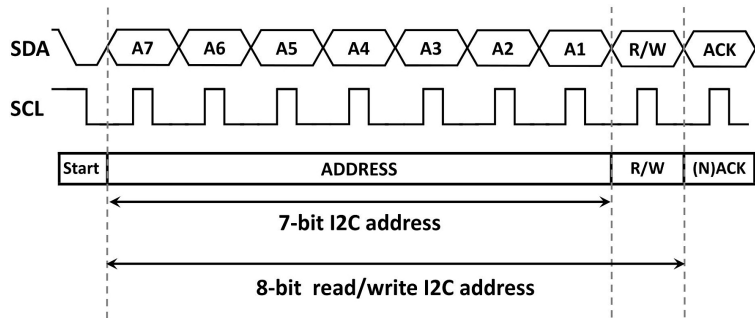

MB7137 Power-Up Timing

The I2CXL-MaxSonar-WR/WRC starts operating within milliseconds of application of power. The major timing of power-up events for the I2CXL-MaxSonar-WR/WRC can be seen in the diagram below.

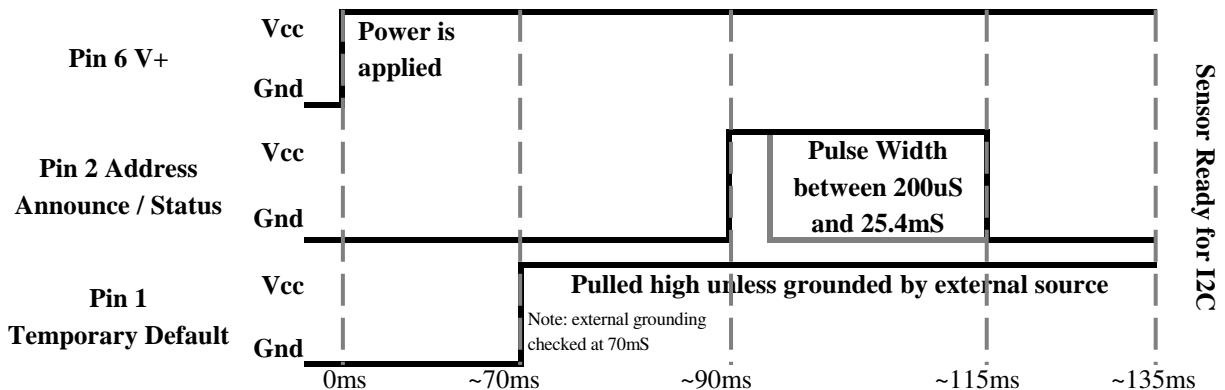

After the sensor is commanded to take a range reading it sends an ultrasonic pulse, waits between ~15ms to ~70ms to detect a target, and determines the range. Then the sensor will resume I2C communications. If the sensor is addressed while in the middle of a range reading, all requests for communication will be responded with a NACK (not acknowledge).

In environments that reflect acoustic noise well, sampling faster than 10Hz could cause the sensor to pick up signals from previous ultrasonic pulses and report false data. It is possible, however, to take range readings at a significantly faster rate in certain environments.

When changing the part address, ensure that power to the sensor is not disrupted or memory corruption may occur. If the memory becomes corrupted, the part should automatically use the default shipped address on power up. It is recommended to avoid changing the address often, as it could cause premature memory failure due to repeated erase/write cycles.

MB7137 Commands

Command	Sequence of Events	Value Used (decimal)	Value Used (binary)	Notes
Take a range reading	<ol style="list-style-type: none"> 1. Initiate a write at the sensor address 2. Write the range command byte 	224 (default) 81	1110 0000 0101 0001	Commands the sensor to take a single range reading and save to distance found for the next range request. It is best to allow 100ms between readings to allow for proper acoustic dissipation.
Report the last range value	<ol style="list-style-type: none"> 1. Initiate a read at the sensor address 2a. Read the two bytes from the sensor starting with the range high byte. 2b. Read the range low byte. 	225 (default) <i>(Sent by sensor)</i> <i>(Sent by sensor)</i>	1110 0001 Range High Byte Values are MSB to LSB	The sensor will report the distance value in cm obtained from its last range reading. Users requiring real-time information should command a range reading ~80ms before reading the sensor. After power-up if no range command is sent the sensor respond with two part info bytes.
Change the sensor address	<ol style="list-style-type: none"> 1. Initiate a write at the sensor address 2a. Write three bytes to the sensor starting with the addr_unlock_1 command 2b. Write the addr_unlock_2 command 2c. Write the new sensor address 	224 (default) 170 165 <i>(User Value)</i>	1110 0000 1010 1010 1010 0101 ##### ###0	The sensor will only accept even address values. If an odd numbered address is sent the sensor will be set to the next lowest even number. If the sensor is told to change to one of the invalid addresses below the sensor will ignore this command and stay at its current address. Invalid Address Values: 0, 80, 164, 170

MB7137 Range Cycle Interrupt

If the sensor receives a request to report the last range value while it is taking a range reading the range reading will be interrupted and a NACK will be sent. If you desire to allow the full range cycle to complete before reading monitor the status pin for the completion of a range cycle or wait for the full 100ms for the range. If the sensor is interrupted and has already found a target the sensor will report the range to the target. If the sensor has not yet found a target when it is interrupted the sensor will send the previous range value. If no range values have been found the distance sent will alternate between 0cm and 255cm.

MB7137 Wiring Diagram

The I2C bus is a two wire interface that consists of a clock line and data line where each requires a pull-up resistor attached to V+. Only one pull-up resistor is required each for the SCL and SDA lines per bus – not per sensor.

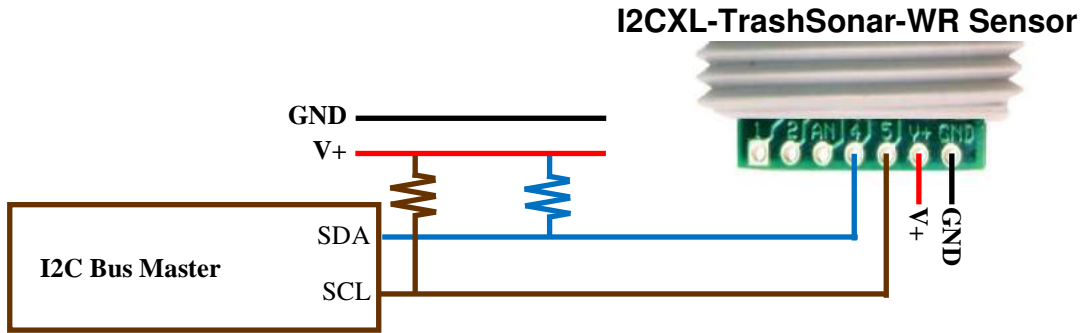

The I2C specification recommends a resistance value of 4.7 kΩ for 20-100kHz interfaces with good low inductance routing. However, these specifications are for communication between chips on a single PCB. If you have longer cable lengths it is best to use lower value resistor, such as 1kΩ, and also to use properly shielded cables. Often I2C bus problems can be fixed by doing one of the following: by using properly shielded cable or by decreasing the value of the pull-up resistors. The I2CXL-TrashSonar-WR/WRC series is capable of sinking more current than the I2C specification requires (15mA versus 3mA) so a much lower resistance value can be used. The voltage applied to the I2C lines should be the same voltage that is applied to V+ of the sensor.

MB7137 Multiple Sensor Wiring Diagram

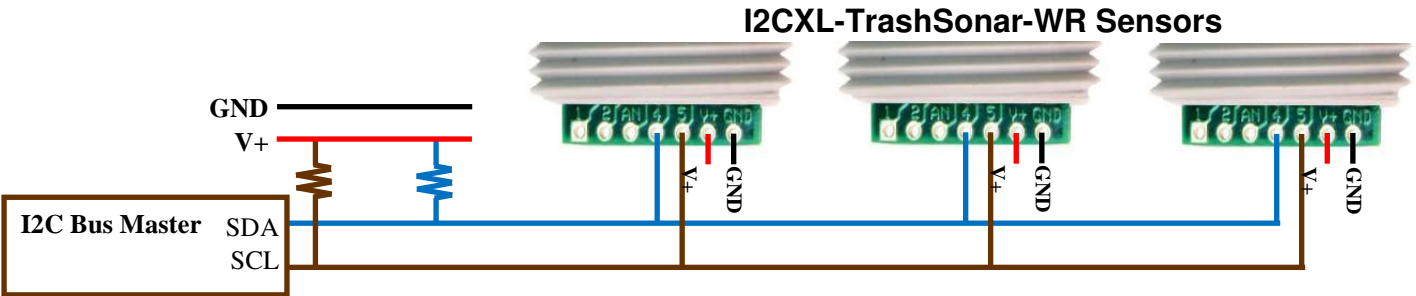

Voltage vs Temperature

The graph below shows minimum operating voltage of the sensor verses temperature.

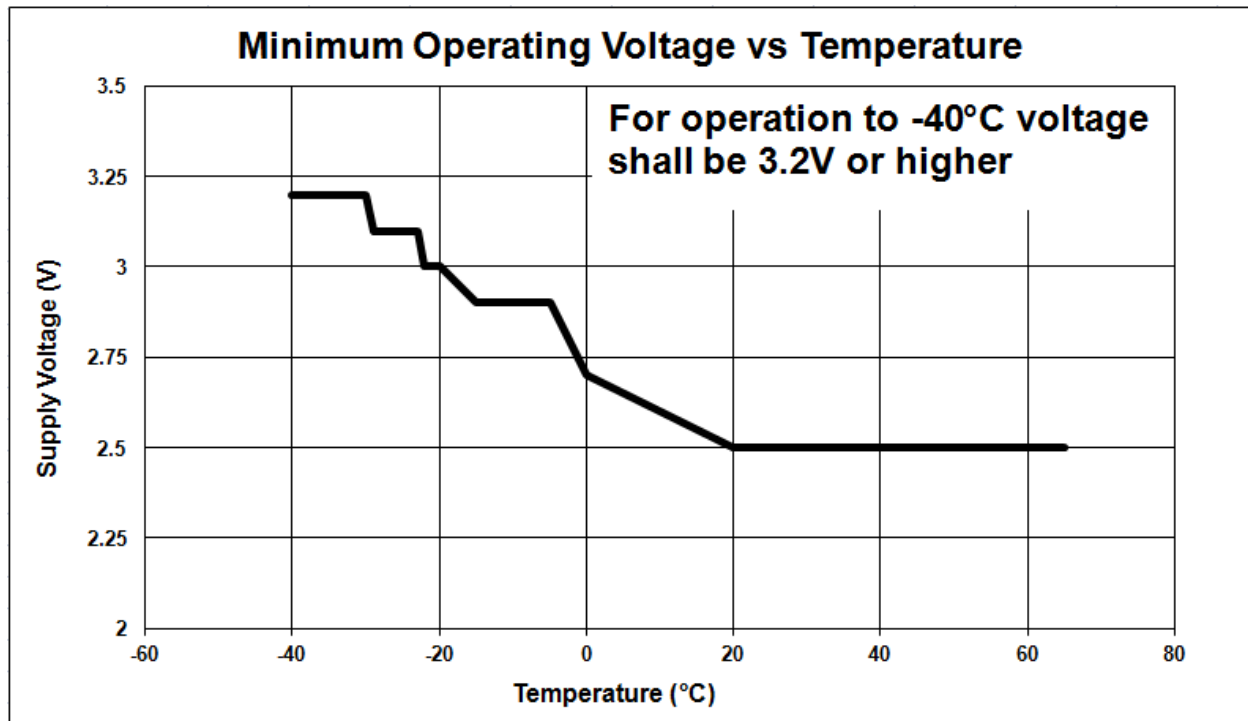

Background Information Regarding our Beam Patterns

Each XL-TrashSonar-WR sensor has an individually calibrated beam pattern, and is matched to provide the approximate detection pattern shown in this datasheet. This allows end users to select the part number that matches their given sensing application. Each part number has a consistent field of detection so additional units of the same part number will have similar beam patterns. The beam plots are provided to help identify an estimated detection zone for an application based on the acoustic properties of a target versus the plotted beam patterns.

Each beam pattern is a 2D representation of the detection area of the sensor. The beam pattern is actually shaped like a 3D cone (having the same detection pattern both vertically and horizontally). Detection patterns for dowels are used to show the beam pattern of each sensor. Dowels are long cylindered targets of a given diameter. The dowels provide consistent target detection characteristics for a given size target which allows easy comparison of one MaxSonar sensor to another MaxSonar sensor.

For each part number, the four patterns (A, B, C, and D) represent the detection zone for a given target size. Each beam pattern shown is determined by the sensor's part number and target size.

The actual beam angle changes over the full range. Use the beam pattern for a specific target at any given distance to calculate the beam angle for that target at the specific distance. Generally, smaller targets are detected over a narrower beam angle and a shorter distance. Larger targets are detected over a wider beam angle and a longer range.

People Sensing:

For users that desire to detect people, the detection area to the 1-inch diameter dowel, in general, represents the area that the sensor will reliably detect people.

MB7137, MB7138, MB7139 XL-TrashSonar™-WR™ Beam Pattern & Uses

The XL-TrashSonar-WR sensors are the recommended sensor for trash level measurement. These sensors reject electrical noise and outside acoustic noise.

MB7137-MB7138-MB7139

XL-TrashSonar™-WR™ Beam Pattern

Sample results for measured beam pattern are shown on a 30-cm grid. The detection pattern is shown for dowels of varying diameters that are placed in front of the sensor.

A 6.1-mm (0.25-inch) diameter dowel

B 2.54-cm (1-inch) diameter dowel

C 8.89-cm (3.5-inch) diameter dowel

D 11-inch wide board moved left to right with the board parallel to the front sensor face.

This shows the sensor's range capability.

Note: For people detection the pattern typically falls between charts A and B.

■ Partial Detection

— 5.0 V

● 3.3 V

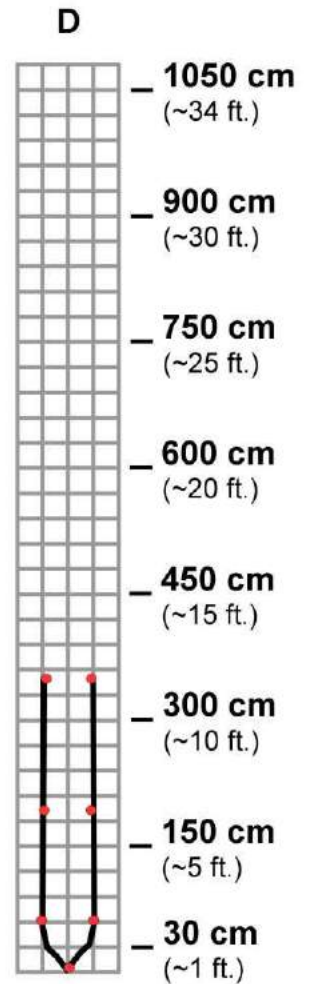
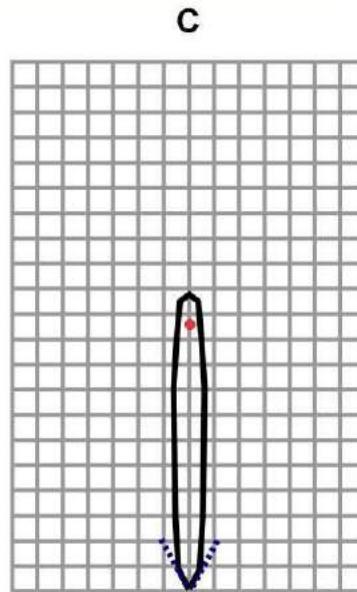
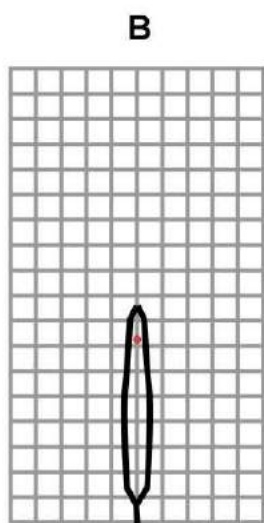
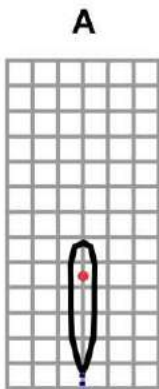

Beam Characteristics are Approximate

Beam Patterns drawn to a 1:95 scale for easy comparison to our other products.

MB7137, MB7138, MB7139

Features and Benefits

- Real-time calibration, noise rejection and additional filtering provides stable range information
- Excellent for applications that require consistently accurate outputs
- Impressive acoustic and electrical noise resistance

MB7137, MB7138, MB7139

Applications and Uses

- Autonomous Navigation
- Environments with acoustic and electrical noise
- Bin Level Measurement
- Tank Level Measurement
- Trash Level measurement

MB713X XL-TrashSonar™ -WR™ Beam Pattern & Uses

The XL-TrashSonar-WR product line is available in alternative housings that include a WRC housing, 1" NPS pipe threading, 1" BSPP pipe threading, and 30mm 1.5 pipe threading.

MB7137-WRC, MB7137-1" NPS, MB7137-1" BSPP, MB7137-30mm1.5
MB7138-WRC, MB7138-1" NPS, MB7138-1" BSPP, MB7138-30mm1.5
MB7139-WRC, MB7139-1" NPS, MB7139-1" BSPP, MB7139-30mm1.5

Sample results for measured beam pattern are shown on a 30-cm grid. The detection pattern is shown for dowels of varying diameters that are placed in front of the sensor.

A 6.1-mm (0.25-inch) diameter dowel

B 2.54-cm (1-inch) diameter dowel

C 8.89-cm (3.5-inch) diameter dowel

D 11-inch wide board moved left to right with the board parallel to the front sensor face.

This shows the sensor's range capability.

Note: For people detection the pattern typically falls between charts A and B.

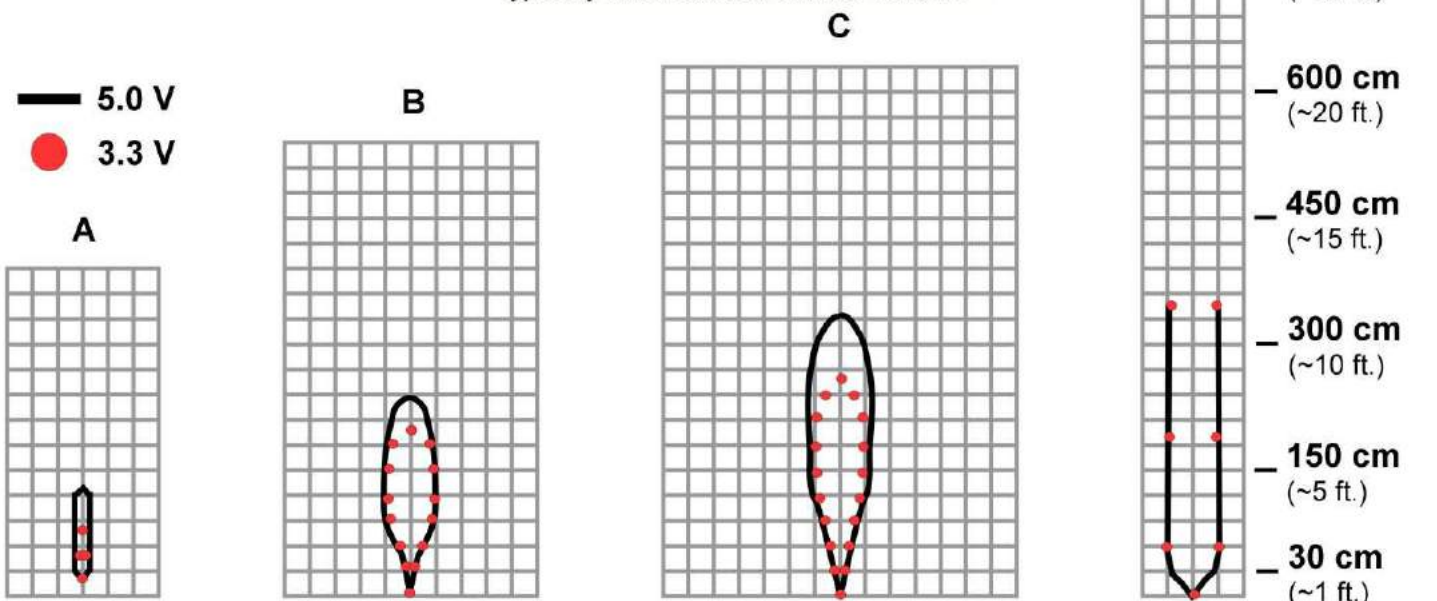

Beam Characteristics are Approximate

Beam Patterns drawn to a 1:95 scale for easy comparison to our other products.

MB713X

Features & Benefits

- Can be flush mounted in an application
- Same resolution as the full horn equivalent
- Available in both metric and imperial housing sizes

MB713X

Applications & Uses

- Autonomous Navigation
- Environments with acoustic and electrical noise
- Bin Level Measurement
- Tank Level Measurement
- Trash Level measurement

MB713X XL-TrashSonar™ -WR™ Beam Pattern & Uses

The XL-TrashSonar-WR product line is available in an UltraCompact alternative housing. The UltraCompact housing is designed for users creating a custom horn mount. The recommended horn can be downloaded from http://www.maxbotix.com/Ultrasonic_Sensors/TrashSonar-Sensors.htm

MB7137 – UltraCompact with a Full Horn

MB7138 – UltraCompact with a Full Horn

MB7139 – UltraCompact with a Full Horn

Sample results for measured beam pattern are shown on a 30-cm grid. The detection pattern is shown for dowels of varying diameters that are placed in front of the sensor.

A 6.1-mm (0.25-inch) diameter dowel

B 2.54-cm (1-inch) diameter dowel

C 8.89-cm (3.5-inch) diameter dowel

D 11-inch wide board moved left to right with the board parallel to the front sensor face.

This shows the sensor's range capability.

Note: For people detection the pattern typically falls between charts A and B.

Partial Detection

5.0 V

3.3 V

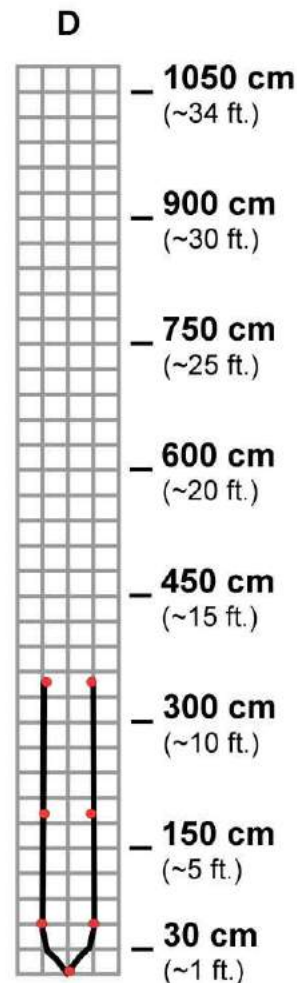
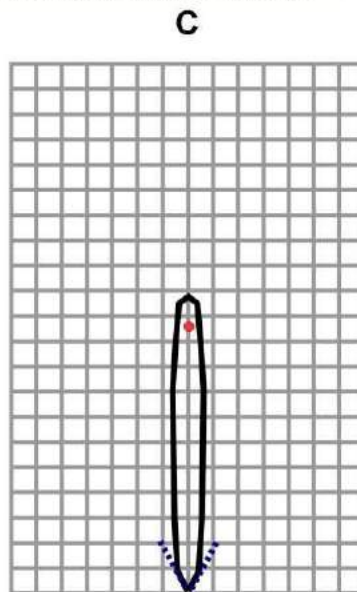
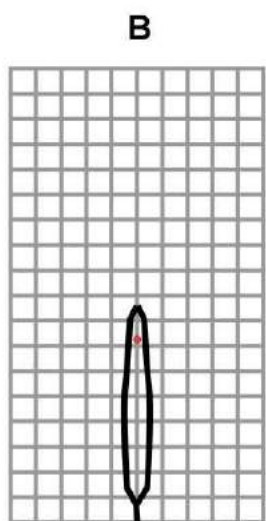
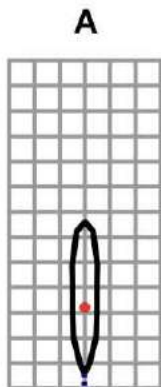

Beam Characteristics are Approximate

Beam Patterns drawn to a 1:95 scale for easy comparison to our other products.

MB713X

Features & Benefits

- Capable of being flush mounted in an application
- Same resolution as the full horn equivalent
- Gives the ability to create custom mounts

MB713X

Applications & Uses

- Autonomous Navigation
- Environments with acoustic and electrical noise
- Bin Level Measurement
- Tank Level Measurement
- Trash Level measurement

MB713X XL-TrashSonar™ -WR™ Beam Pattern & Uses

The XL-TrashSonar-WR product line is available in an UltraCompact alternative housing. The UltraCompact housing is designed for users creating a custom flush mount.

- MB7137 – UltraCompact Flush Mount**
- MB7138 – UltraCompact Flush Mount**
- MB7139 – UltraCompact Flush Mount**

Sample results for measured beam pattern are shown on a 30-cm grid. The detection pattern is shown for dowels of varying diameters that are placed in front of the sensor.

- A** 6.1-mm (0.25-inch) diameter dowel
- B** 2.54-cm (1-inch) diameter dowel
- C** 8.89-cm (3.5-inch) diameter dowel

D 11-inch wide board moved left to right with the board parallel to the front sensor face. This shows the sensor's range capability.

Note: For people detection the pattern typically falls between charts A and B.

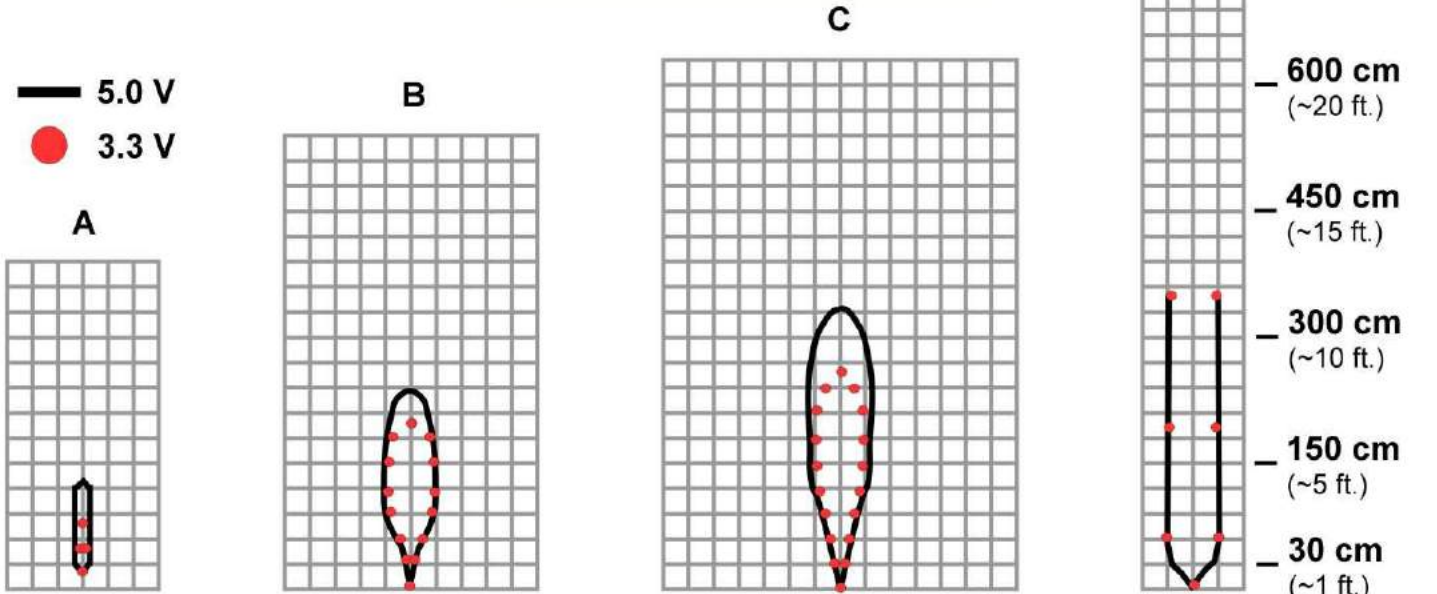

Beam Characteristics are Approximate

Beam Patterns drawn to a 1:95 scale for easy comparison to our other products.

MB713X

Features & Benefits

- Capable of being flush mounted in an application
- Same resolution as the full horn equivalent
- Gives the ability to create custom mounts

MB713X

Applications & Uses

- Autonomous Navigation
- Environments with acoustic and electrical noise
- Bin Level Measurement
- Tank Level Measurement
- Trash Level measurement

Part Numbers

All part numbers are a combination of a six-character base followed by a dash and a three-digit product code. Please review the following table for more information on the three-digit product code.

Note: Active part numbers listed on page 21.

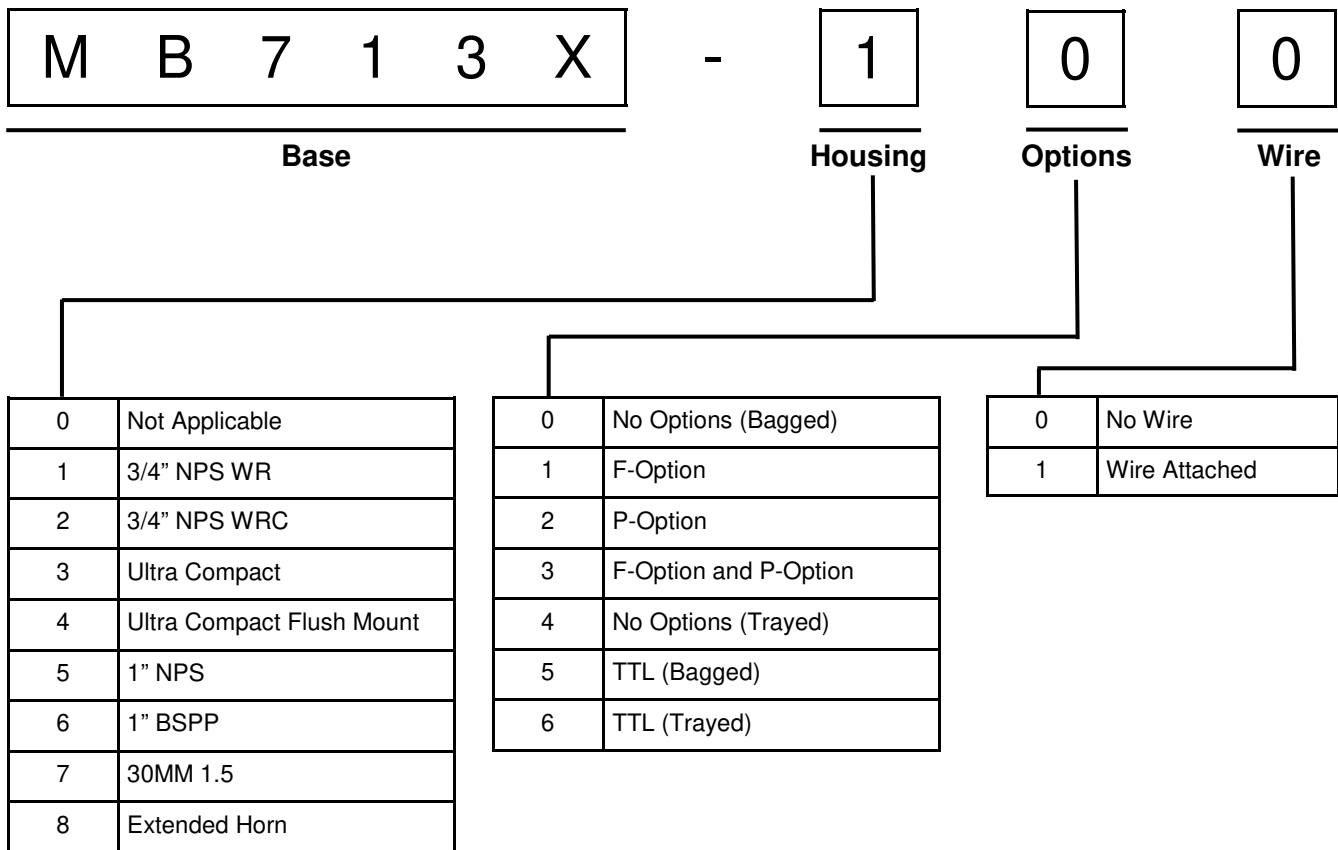

The following tables display all of the active and valid part numbers for these products.

Active Part Numbers for MB7137							
MB7137-100	MB7137-101	MB7137-110	MB7137-111	MB7137-120	MB7137-121	MB7137-130	MB7137-131
MB7137-200	MB7137-201	MB7137-210	MB7137-211	MB7137-220	MB7137-221	MB7137-230	MB7137-231
MB7137-300	MB7137-320	MB7137-400	MB7137-420	MB7137-500	MB7137-501	MB7137-510	MB7137-511
MB7137-520	MB7137-521	MB7137-530	MB7137-531	MB7137-600	MB7137-601	MB7137-610	MB7137-611
MB7137-620	MB7137-621	MB7137-630	MB7137-631	MB7137-700	MB7137-701	MB7137-710	MB7137-711
MB7137-720	MB7137-721	MB7137-730	MB7137-731				

Active Part Numbers for MB7138							
MB7138-100	MB7138-101	MB7138-110	MB7138-111	MB7138-120	MB7138-121	MB7138-130	MB7138-131
MB7138-200	MB7138-201	MB7138-210	MB7138-211	MB7138-220	MB7138-221	MB7138-230	MB7138-231
MB7138-300	MB7138-320	MB7138-400	MB7138-420	MB7138-500	MB7138-501	MB7138-510	MB7138-511
MB7138-520	MB7138-521	MB7138-530	MB7138-531	MB7138-600	MB7138-601	MB7138-610	MB7138-611
MB7138-620	MB7138-621	MB7138-630	MB7138-631	MB7138-700	MB7138-701	MB7138-710	MB7138-711
MB7138-720	MB7138-721	MB7138-730	MB7138-731				

Active Part Numbers for MB7139							
MB7139-100	MB7139-101	MB7139-110	MB7139-111	MB7139-120	MB7139-121	MB7139-130	MB7139-131
MB7139-200	MB7139-201	MB7139-210	MB7139-211	MB7139-220	MB7139-221	MB7139-230	MB7139-231
MB7139-300	MB7139-320	MB7139-400	MB7139-420	MB7139-500	MB7139-501	MB7139-510	MB7139-511
MB7139-520	MB7139-521	MB7139-530	MB7139-531	MB7139-600	MB7139-601	MB7139-610	MB7139-611
MB7139-620	MB7139-621	MB7139-630	MB7139-631	MB7139-700	MB7139-701	MB7139-710	MB7139-711
MB7139-720	MB7139-721	MB7139-730	MB7139-731				