



Chipsmall Limited consists of a professional team with an average of over 10 year of expertise in the distribution of electronic components. Based in Hongkong, we have already established firm and mutual-benefit business relationships with customers from,Europe,America and south Asia,supplying obsolete and hard-to-find components to meet their specific needs.

With the principle of “Quality Parts,Customers Priority,Honest Operation,and Considerate Service”,our business mainly focus on the distribution of electronic components. Line cards we deal with include Microchip,ALPS,ROHM,Xilinx,Pulse,ON,Everlight and Freescale. Main products comprise IC,Modules,Potentiometer,IC Socket,Relay,Connector.Our parts cover such applications as commercial,industrial, and automotives areas.

We are looking forward to setting up business relationship with you and hope to provide you with the best service and solution. Let us make a better world for our industry!



Contact us

Tel: +86-755-8981 8866 Fax: +86-755-8427 6832

Email & Skype: info@chipsmall.com Web: www.chipsmall.com

Address: A1208, Overseas Decoration Building, #122 Zhenhua RD., Futian, Shenzhen, China



Graphics Display Controller for Automotive Applications

MB86297/MB86276

A compact optimal controller for various display systems, including automobile-mounted navigation and instrument panels. It realizes high-speed 3D and 2D graphics processing with high quality and sophistication.

Overview

In addition to driving performance, which is the basis of automobile functions, car electronics technology utilized to realize enhanced safety and comfort continues to advance steadily. Automotive semiconductor products contribute to this technological advance. For many years, FUJITSU has provided high-function, high-quality semiconductor products for a variety of applications, including control and information systems.

This article introduces two new products, MB86297 and MB86276, which were developed as the fourth generation of MB86290 Series of graphics display controllers for car navigation systems. They have had a good reputation for providing the world's best performance and sales since their release in 1998.

MB86297 is used in high-end navigation systems in which devices that execute high-reality three-dimensional (3D) map rendering at high speed are required. It realizes an approximately 10-fold speed up over third-generation products.

MB86276 can also be used in instrument panels and in-car information terminals that incorporate the same rendering engine and display engine as third-generation products. It realizes high-grade graphic image systems at low cost.

Product Features

■ MB86297 (Product for high-end car navigation systems)

Table 1 presents the main specifications and Fig.1 shows

Photo 1 External View (MB86297)

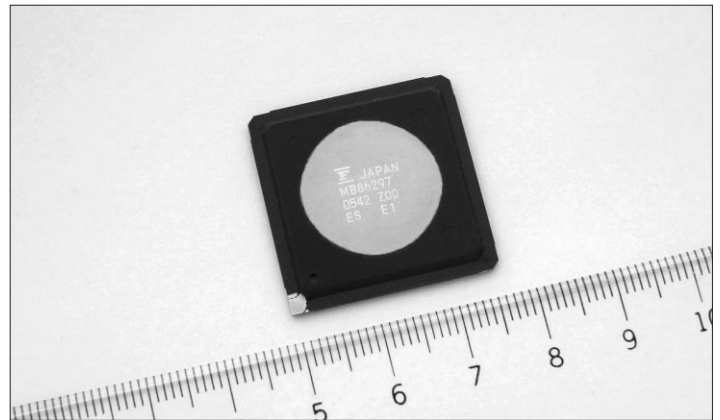
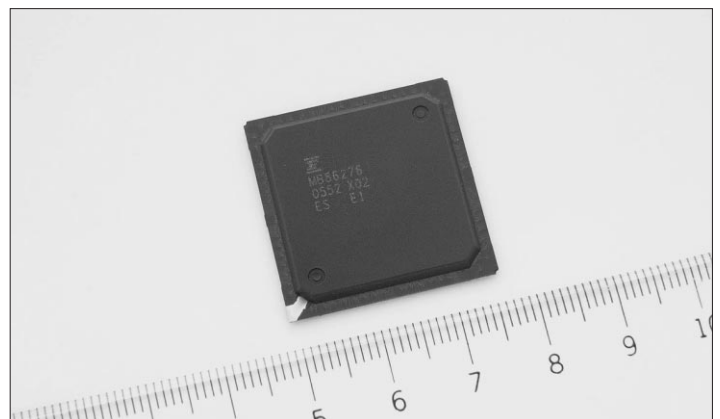

Photo 2 External View (MB86276)



the block diagram for MB86297.

The main features of MB86297 are as follows:

High-performance/high-function graphics processing

A graphics processor with an operation frequency of 266MHz has been newly developed. Rendering performance has been dramatically improved over that of conventional products. It realizes graphics processing performance of 10M polygons/sec, 250M pixels/sec. Furthermore, high-speed rendering of highly realistic maps has become possible by mounting vertex processing functions such as lighting and OpenGL ES rendering acceleration functions for higher functions.

Overlay function for up to 8 layers and alpha-blending function

It is capable of displaying 8 screens, each in a different window, and overlaying them. It also uses up to 4 alpha-blending coefficient planes on which pixel-unit alpha-blending is possible. This allows the easy realization of an eye-friendly GUI by assigning a 2D or 3D map, landmark, warning display, and menu screen to each layer and blending them.

Realizes up to 1,280×1,024 pixels display resolution

The display resolution can be flexibly set up to 1,280×1,024 pixels. It is also equipped with 2 channels of image output ports, allowing different images to be simultaneously output to two LCD panels such as in the front and rear seats.

Table 1 Main Specifications (MB86297)

Internal operating frequency	Graphics processor: 266MHz (Maximum value, external supply clock 14.32MHz)
Operating voltage	Internal circuit: 1.2±0.10V External I/O: 3.3±0.3V External memory interface: 2.5±0.2V
Package	TEBGA (Thermally Enhanced Ball Grid Array) 543 pins
Technology	CMOS 90nm

Figure 1 Block Diagram (MB86297)

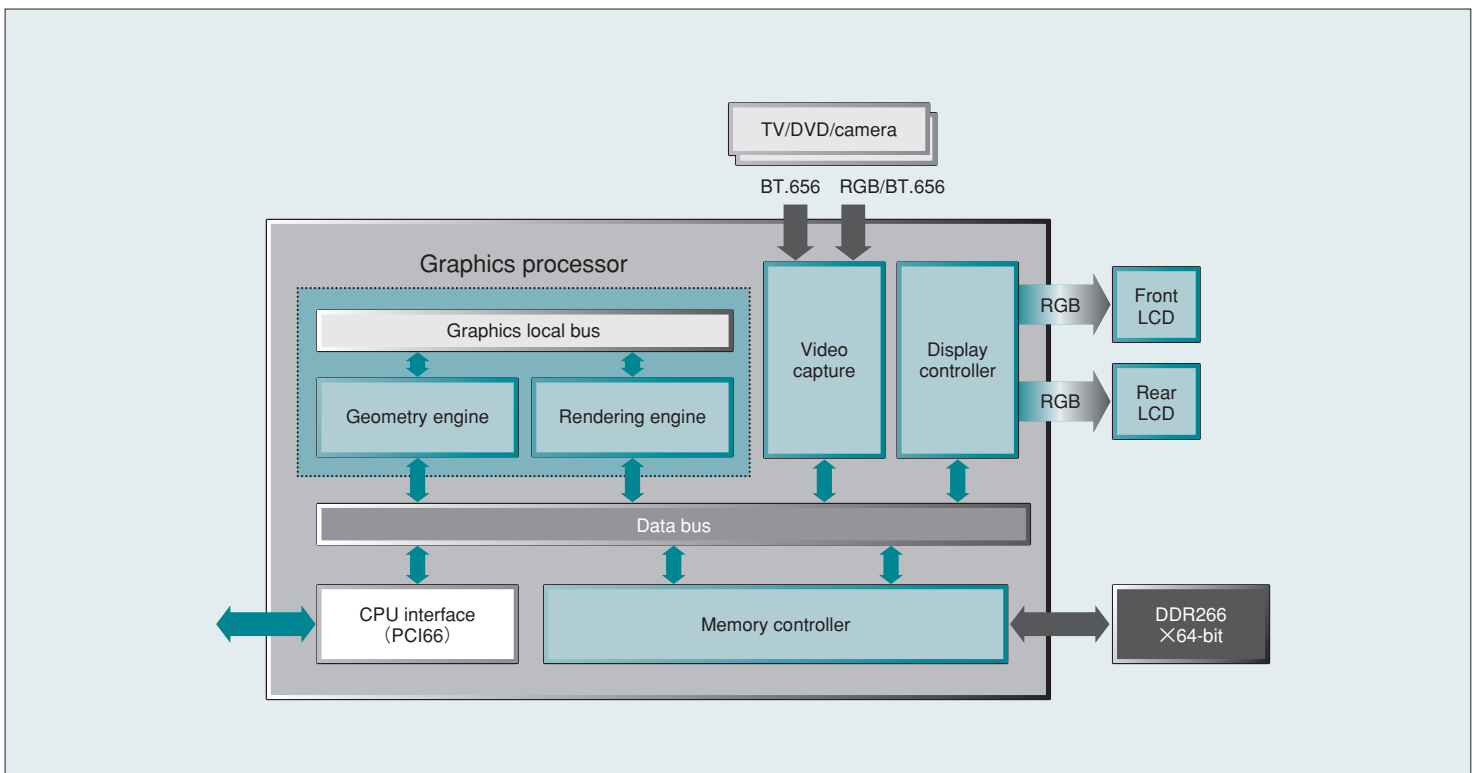

Digital video capture function

Two channels of digital video image input ports for TV, etc. are prepared. Images for DVDs and rear cameras can be zoomed in/out for display by overlaying with maps, etc.

Capable of high-speed connection to graphics memory up to 128Mbytes

It is possible to connect up to 128Mbytes of DDR SDRAM as the graphics memory. This product is capable of graphics memory access at a data transfer rate up to 2 Gbytes/sec through connection with 64-bit memory bus and 133MHz clock frequency, enabling the overlaying display of multiple layers at high resolution.

MB86276 (product for instrument panel/in-car information terminal)

Table 2 presents the main specifications and Fig.2 the block diagram of MB86276.

The main features of MB86276 are as follows:

Inherited rendering and display functions of third-generation LSIs (MB86293, MB86294, and MB86296)

This product mounts the same rendering engine and display engine as the third-generation graphics LSI. It is capable of realizing high-grade graphic image systems by overlaying various automotive data with DVD or camera images.

Table 2 Main Specifications (MB86276)

Internal operating frequency	Rendering engine block: 133MHz (Maximum value, external supply clock 14.32MHz)
Operating voltage	Internal circuit: 1.8±0.15V external I/O: 3.3±0.3V
Package	PBGA (Plastic Ball Grid Array) 320 pins
Technology	CMOS 0.18 μm

Figure 2 Block Diagram (MB86276)

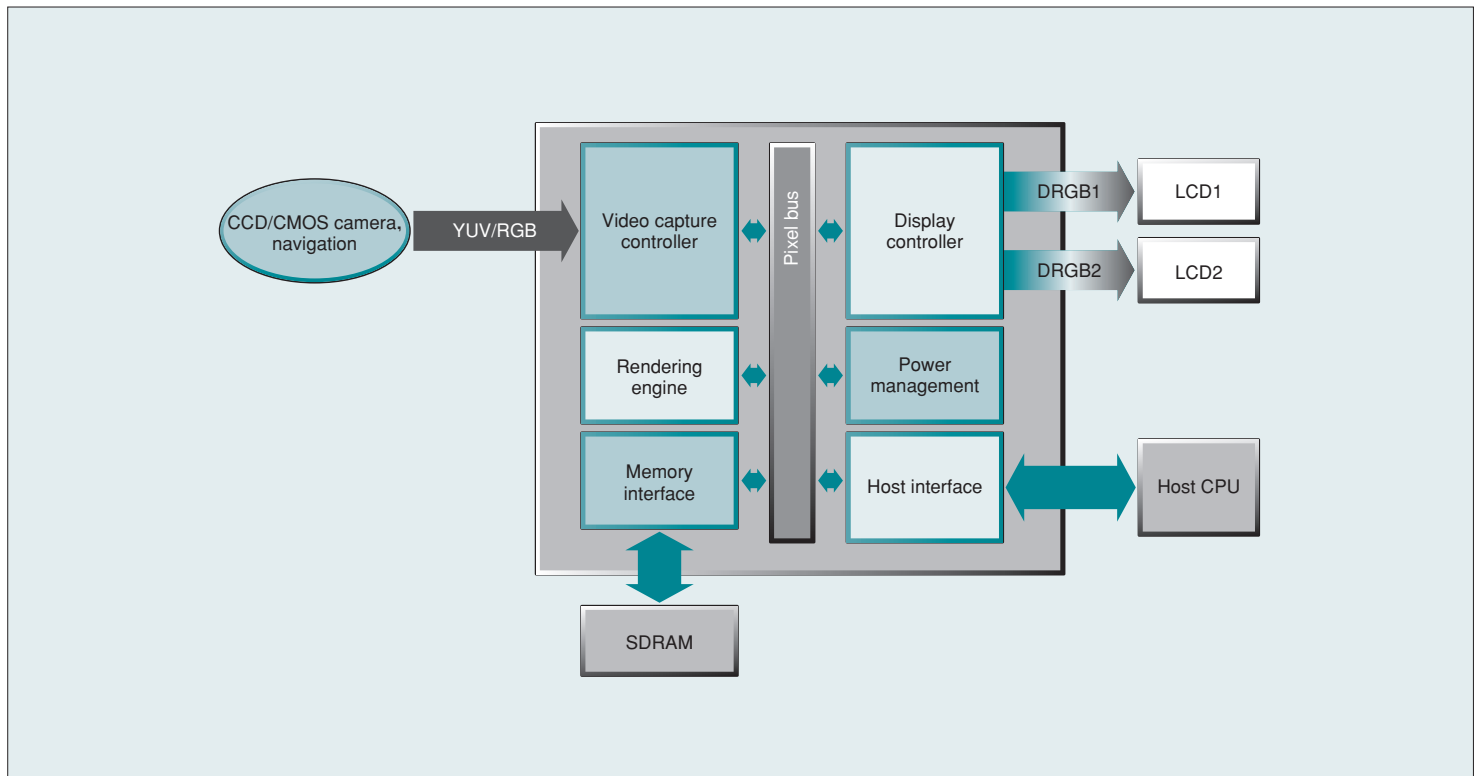

Supports diverse host interface methods

In addition to the conventional 32-bit SRAM type, it supports various host interfaces including the 16-bit SRAM type and multiplexed address/data bus. It can easily be used by connecting it to FUJITSU's FR microcontrollers.

Video texture function

It is possible to rotate or deform video images by inputting digital video images from the camera, etc. and handling them as texture data. This function can be used in various applications such as camera image distortion correction.

Photo 3 shows an example of distortion correction.

Evaluation and Development Environment and Software

Reference board

A reference board is available as a development kit for evaluation and software development.

The evaluation board for MB86297 is in the form of a PCI card. It can be used by connecting it to the PCI bus of a Windows® XP PC, etc.

Photo 3 Example of Distortion Correction

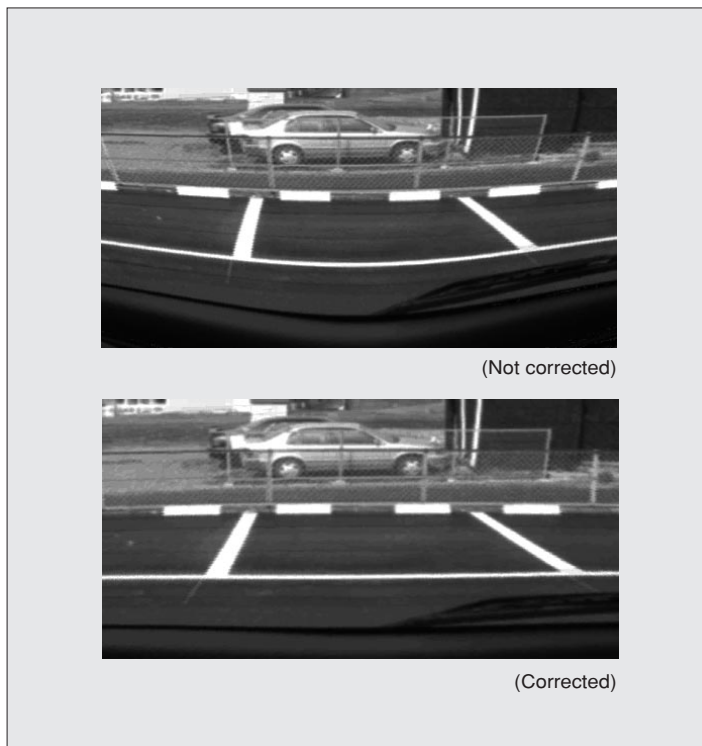

MB86276 evaluation board is also available in a form that can be joined with FUJITSU's 32-bit CPU FR microcontroller evaluation board.

Graphics access library

For application software development, the graphics access library is available. This is a software application that defines the group of API commands that can execute various settings and graphics-rendering functions of the graphics display controller. Considering optimization for each application and reconstruction in system incorporation, it is possible to provide the license for source programs in the graphics access library.

OpenGL ES library for MB86297 (to be released)

The release of a software library conforming to OpenGL ES 1.1 is planned for MB86297. This OpenGL ES library, which is a standard graphics API optimized for the incorporated application, will realize an incorporated system that can handle full-scale 3D graphics images simply. It will also dramatically reduce software development time.

Fig.3 shows the software configuration.

Figure 3 MB86297 Software Configuration

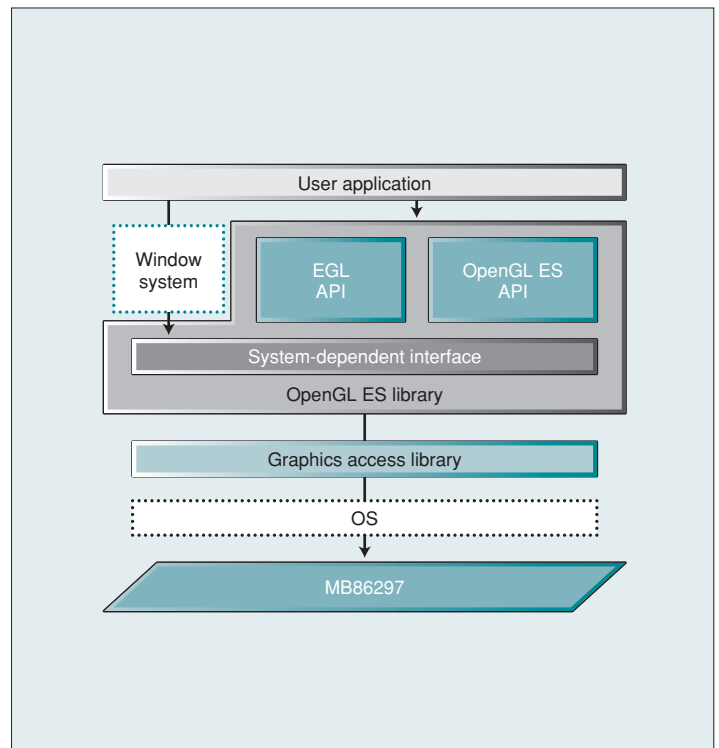

Future Development

Fig.4 shows the roadmap of our graphics display controllers. FUJITSU will continue to develop products for high-end navigation products with rendering performance at higher speed and reinforced rendering functions optimal for various applications. FUJITSU will also continue to pursue enhanced cost performance in development of instrument panels and in-car information terminals. Furthermore, to meet the market needs, the development of new-generation graphic system LSI products that integrate various multimedia functions (video, audio, etc.) and mount CPU and various IO functions, is in planning. *

NOTES

* Windows is a registered trademark or a trademark of the U.S. Microsoft Corporation in the U.S. and other nations.

Photo 4 Evaluation Board for MB86297

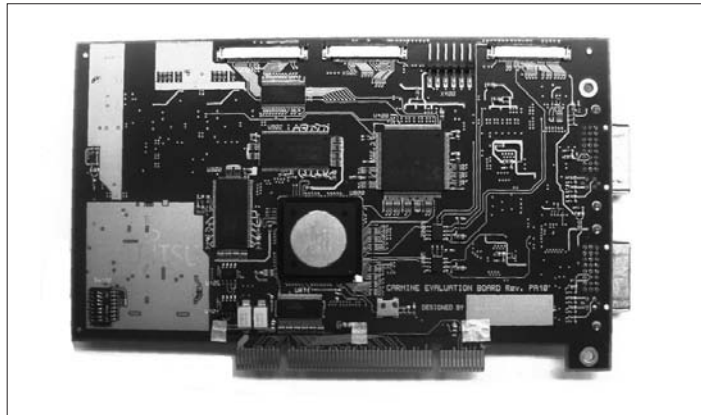

Photo 5 Evaluation Board for MB86276

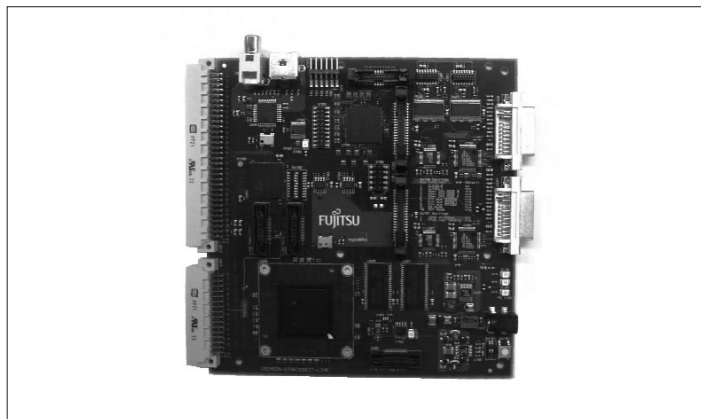

Figure 4 Roadmap of Graphics Display Controller

