



Chipsmall Limited consists of a professional team with an average of over 10 year of expertise in the distribution of electronic components. Based in Hongkong, we have already established firm and mutual-benefit business relationships with customers from,Europe,America and south Asia,supplying obsolete and hard-to-find components to meet their specific needs.

With the principle of “Quality Parts,Customers Priority,Honest Operation,and Considerate Service”,our business mainly focus on the distribution of electronic components. Line cards we deal with include Microchip,ALPS,ROHM,Xilinx,Pulse,ON,Everlight and Freescale. Main products comprise IC,Modules,Potentiometer,IC Socket,Relay,Connector.Our parts cover such applications as commercial,industrial, and automotives areas.

We are looking forward to setting up business relationship with you and hope to provide you with the best service and solution. Let us make a better world for our industry!



## Contact us

Tel: +86-755-8981 8866 Fax: +86-755-8427 6832

Email & Skype: info@chipsmall.com Web: www.chipsmall.com

Address: A1208, Overseas Decoration Building, #122 Zhenhua RD., Futian, Shenzhen, China



# MBR2045EMFS, NRVB2045EMFS

## Switch-mode Power Rectifiers

These state-of-the-art devices have the following features:

### Features

- Low Power Loss / High Efficiency
- New Package Provides Capability of Inspection and Probe After Board Mounting
- Guardring for Stress Protection
- Low Forward Voltage Drop
- 150°C Operating Junction Temperature
- Wettable Flacks Option Available
- NRV Prefix for Automotive and Other Applications Requiring Unique Site and Control Change Requirements; AEC-Q101 Qualified and PPAP Capable
- These are Pb-Free and Halide-Free Devices

### Mechanical Characteristics:

- Case: Epoxy, Molded
- Epoxy Meets Flammability Rating UL 94-0 @ 0.125 in.
- Lead Finish: 100% Matte Sn (Tin)
- Lead and Mounting Surface Temperature for Soldering Purposes: 260°C Max. for 10 Seconds
- Device Meets MSL 1 Requirements

### Applications

- Excellent Alternative to DPAK in Space-Constrained Automotive Applications
- Output Rectification in Compact Portable Consumer Applications
- Freewheeling Diode used with Inductive Loads



**ON Semiconductor®**

<http://onsemi.com>

## SCHOTTKY BARRIER RECTIFIERS 20 AMPERES 45 VOLTS

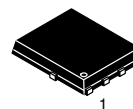
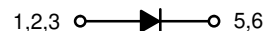

SO-8 FLAT LEAD  
CASE 488AA  
STYLE 2

### MARKING DIAGRAM

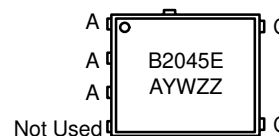

B2045E = Specific Device Code  
A = Assembly Location  
Y = Year  
W = Work Week  
ZZ = Lot Traceability

### ORDERING INFORMATION

| Device          | Package              | Shipping†             |
|-----------------|----------------------|-----------------------|
| MBR2045EMFST1G  | SO-8 FL<br>(Pb-Free) | 1500 /<br>Tape & Reel |
| MBR2045EMFST3G  | SO-8 FL<br>(Pb-Free) | 5000 /<br>Tape & Reel |
| NRVB2045EMFST1G | SO-8 FL<br>(Pb-Free) | 1500 /<br>Tape & Reel |
| NRVB2045EMFST3G | SO-8 FL<br>(Pb-Free) | 5000 /<br>Tape & Reel |

†For information on tape and reel specifications, including part orientation and tape sizes, please refer to our Tape and Reel Packaging Specification Brochure, BRD8011/D.

# MBR2045EMFS, NRVB2045EMFS

## MAXIMUM RATINGS

| Rating  | Symbol                          | Value       | Unit             |
|---|---------------------------------|-------------|------------------|
| Peak Repetitive Reverse Voltage<br>Working Peak Reverse Voltage<br>DC Blocking Voltage                      | $V_{RRM}$<br>$V_{RWM}$<br>$V_R$ | 45          | V                |
| Average Rectified Forward Current<br>(Rated $V_R$ , $T_C = 130^\circ\text{C}$ )                             | $I_{F(AV)}$                     | 20          | A                |
| Peak Repetitive Forward Current,<br>(Rated $V_R$ , Square Wave, 20 kHz, $T_C = 120^\circ\text{C}$ )         | $I_{FRM}$                       | 40          | A                |
| Non-Repetitive Peak Surge Current<br>(Surge Applied at Rated Load Conditions Halfwave, Single Phase, 60 Hz) | $I_{FSM}$                       | 400         | A                |
| Storage Temperature Range   | $T_{stg}$                       | -65 to +175 | $^\circ\text{C}$ |
| Operating Junction Temperature  | $T_J$                           | -55 to +150 | $^\circ\text{C}$ |
| Unclamped Inductive Switching Energy (10 mH Inductor, Non-repetitive)                                       | $E_{AS}$                        | 150         | mJ               |
| ESD Rating (Human Body Model)   |                                 | 3B          |                  |
| ESD Rating (Machine Model)  |                                 | M4          |                  |

Stresses exceeding those listed in the Maximum Ratings table may damage the device. If any of these limits are exceeded, device functionality should not be assumed, damage may occur and reliability may be affected.

NOTE: The heat generated must be less than the thermal conductivity from Junction-to-Ambient:  $dPD/dT_J < 1/R_{JA}$

## THERMAL CHARACTERISTICS

| Characteristic  | Symbol          | Typ | Max | Unit                      |
|---|-----------------|-----|-----|---------------------------|
| Thermal Resistance, Junction-to-Case, Steady State<br>(Assumes 600 mm <sup>2</sup> 1 oz. copper bond pad, on a FR4 board) | $R_{\theta JC}$ | -   | 1.6 | $^\circ\text{C}/\text{W}$ |

## ELECTRICAL CHARACTERISTICS

|  |       |      |      |    |
|--|-------|------|------|----|
| Instantaneous Forward Voltage (Note 1)<br>( $i_F = 10\text{ A}$ , $T_J = 125^\circ\text{C}$ )<br>( $i_F = 10\text{ A}$ , $T_J = 25^\circ\text{C}$ )<br>( $i_F = 20\text{ A}$ , $T_J = 125^\circ\text{C}$ )<br>( $i_F = 20\text{ A}$ , $T_J = 25^\circ\text{C}$ ) | $V_F$ | 0.35 | 0.47 | V  |
|  |       | 0.45 | 0.56 |    |
|  |       | 0.43 | 0.58 |    |
|  |       | 0.51 | 0.64 |    |
| Instantaneous Reverse Current (Note 1)<br>(Rated dc Voltage, $T_J = 125^\circ\text{C}$ )<br>(Rated dc Voltage, $T_J = 25^\circ\text{C}$ )  | $i_R$ | 48   | 100  | mA |
|  |       | 0.09 | 0.40 |    |

Product parametric performance is indicated in the Electrical Characteristics for the listed test conditions, unless otherwise noted. Product performance may not be indicated by the Electrical Characteristics if operated under different conditions.

1. Pulse Test: Pulse Width = 300  $\mu\text{s}$ , Duty Cycle  $\leq 2.0\%$ .

# MBR2045EMFS, NRVB2045EMFS

## TYPICAL CHARACTERISTICS

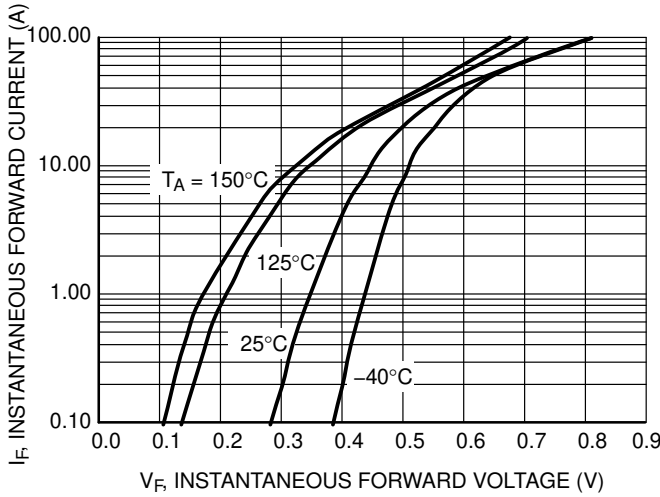

**Figure 1. Typical Instantaneous Forward Voltage**

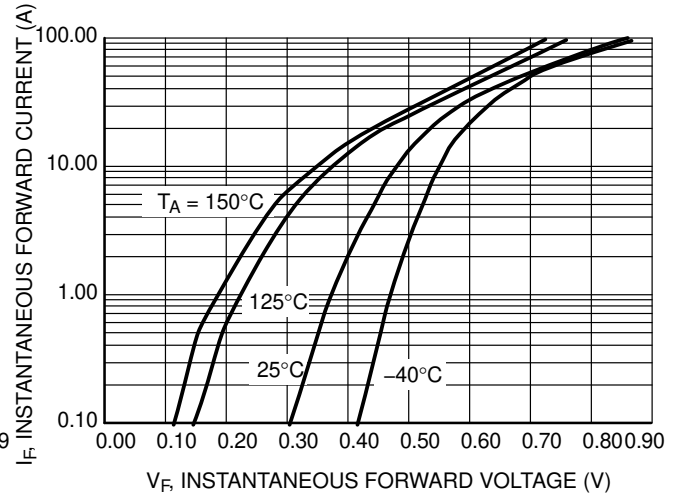

**Figure 2. Maximum Instantaneous Forward Voltage**

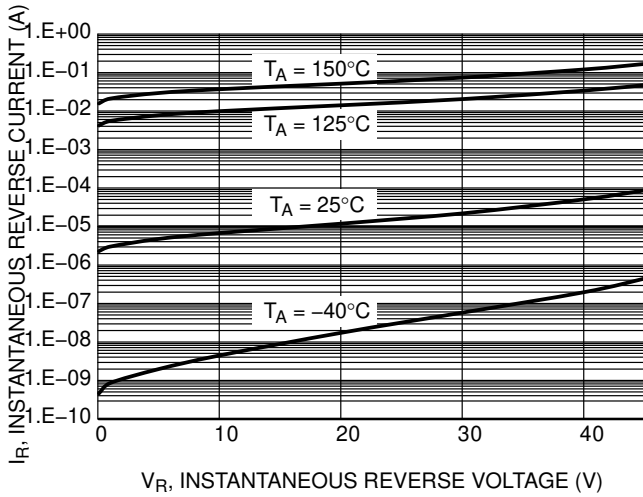

**Figure 3. Typical Reverse Characteristics**

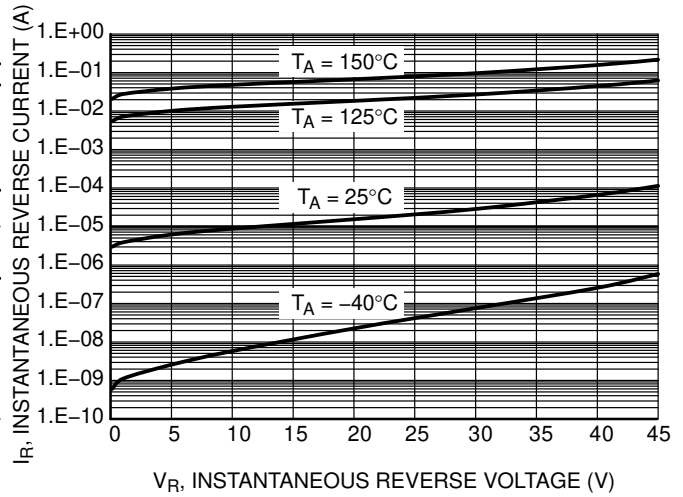

**Figure 4. Maximum Reverse Characteristics**

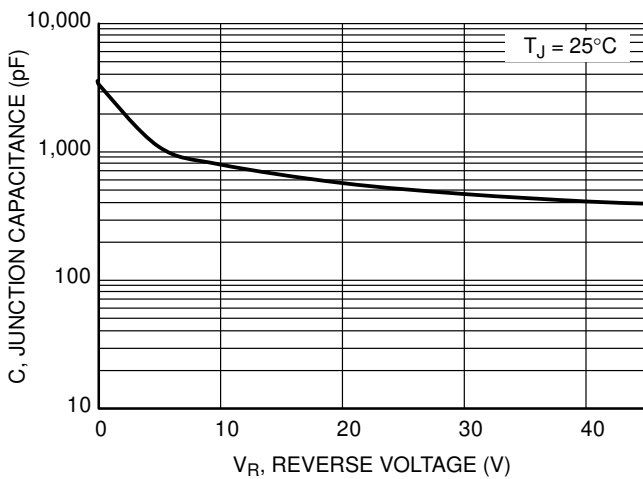

**Figure 5. Typical Junction Capacitance**

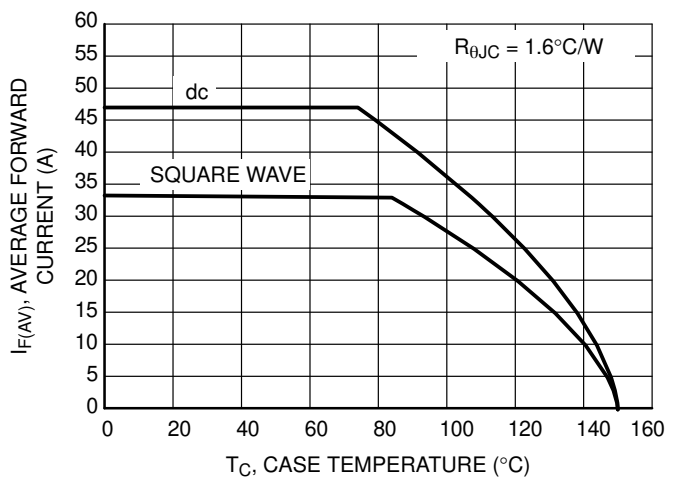

**Figure 6. Current Derating**

# MBR2045EMFS, NRVB2045EMFS

## TYPICAL CHARACTERISTICS

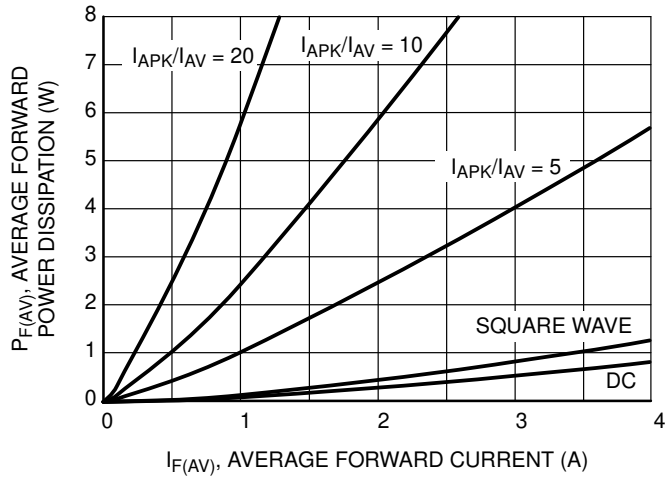

Figure 7. Forward Power Dissipation

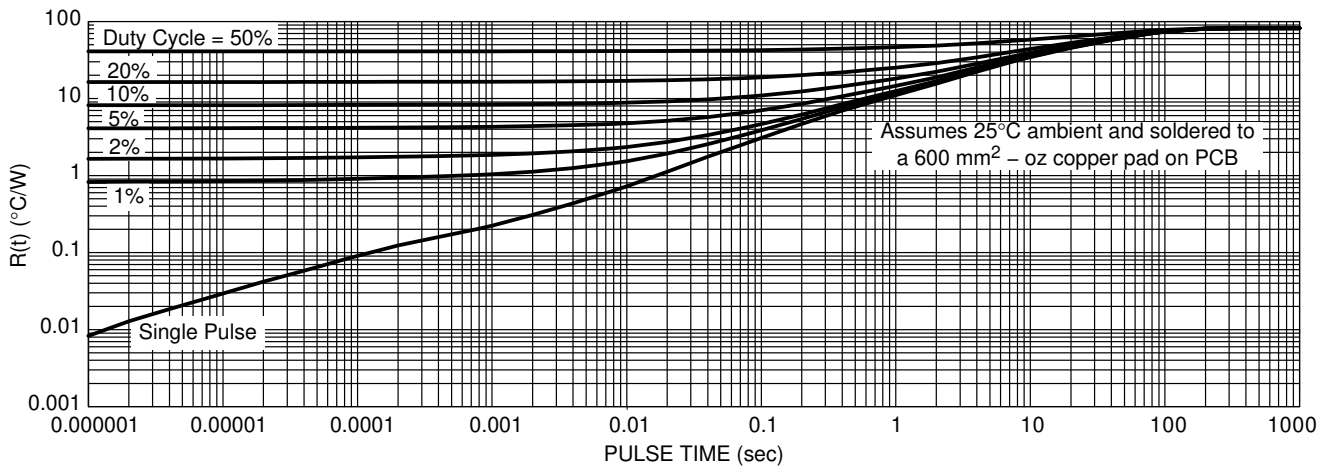
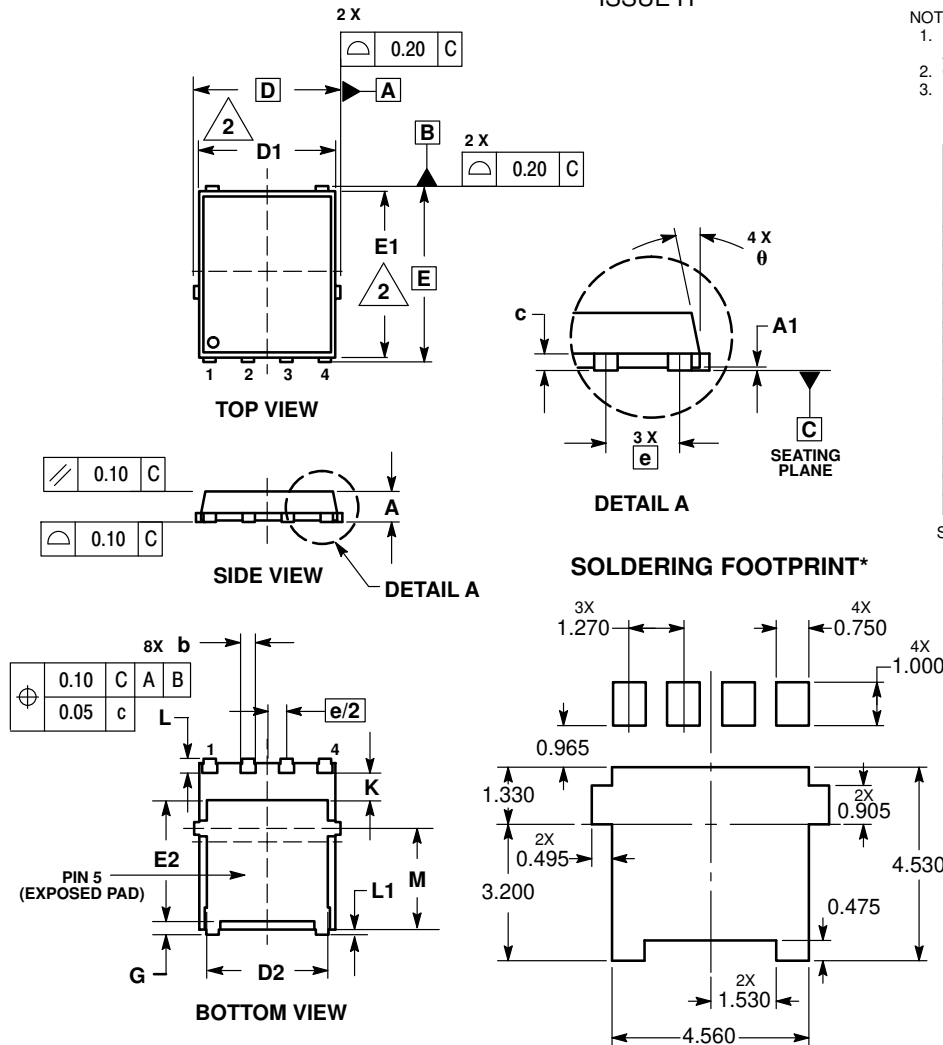

Figure 8. Thermal Response

# MBR2045EMFS, NRVB2045EMFS

## PACKAGE DIMENSIONS

DFN5 5x6, 1.27P  
(SO-8FL)  
CASE 488AA  
ISSUE H



NOTES:

1. DIMENSIONING AND TOLERANCING PER ASME Y14.5M, 1994.
2. CONTROLLING DIMENSION: MILLIMETER.
3. DIMENSION D1 AND E1 DO NOT INCLUDE MOLD FLASH PROTRUSIONS OR GATE BURRS.

| DIM | MILLIMETERS |      |      |
|-----|-------------|------|------|
|     | MIN         | NOM  | MAX  |
| A   | 0.90        | 1.00 | 1.10 |
| A1  | 0.00        | ---  | 0.05 |
| b   | 0.33        | 0.41 | 0.51 |
| c   | 0.23        | 0.28 | 0.33 |
| D   | 5.15 BSC    |      |      |
| D1  | 4.70        | 4.90 | 5.10 |
| D2  | 3.80        | 4.00 | 4.20 |
| E   | 6.15 BSC    |      |      |
| E1  | 5.70        | 5.90 | 6.10 |
| E2  | 3.45        | 3.65 | 3.85 |
| e   | 1.27 BSC    |      |      |
| G   | 0.51        | 0.61 | 0.71 |
| K   | 1.20        | 1.35 | 1.50 |
| L   | 0.51        | 0.61 | 0.71 |
| L1  | 0.05        | 0.17 | 0.20 |
| M   | 3.00        | 3.40 | 3.80 |
| θ   | 0°          | ---  | 12°  |

STYLE 2:

- PIN 1. ANODE
- ANODE
- ANODE
- NO CONNECT
- CATHODE

\*For additional information on our Pb-Free strategy and soldering details, please download the ON Semiconductor Soldering and Mounting Techniques Reference Manual, SOLDERRM/D.

ON Semiconductor and are registered trademarks of Semiconductor Components Industries, LLC (SCILLC). SCILLC owns the rights to a number of patents, trademarks, copyrights, trade secrets, and other intellectual property. A listing of SCILLC's product/patent coverage may be accessed at [www.onsemi.com/site/pdf/Patent-Marking.pdf](http://www.onsemi.com/site/pdf/Patent-Marking.pdf). SCILLC reserves the right to make changes without further notice to any products herein. SCILLC makes no warranty, representation or guarantee regarding the suitability of its products for any particular purpose, nor does SCILLC assume any liability arising out of the application or use of any product or circuit, and specifically disclaims any and all liability, including without limitation special, consequential or incidental damages. "Typical" parameters which may be provided in SCILLC data sheets and/or specifications can and do vary in different applications and actual performance may vary over time. All operating parameters, including "Typicals" must be validated for each customer application by customer's technical experts. SCILLC does not convey any license under its patent rights nor the rights of others. SCILLC products are not designed, intended, or authorized for use as components in systems intended for surgical implant into the body, or other applications intended to support or sustain life, or for any other application in which the failure of the SCILLC product could create a situation where personal injury or death may occur. Should Buyer purchase or use SCILLC products for any such unintended or unauthorized application, Buyer shall indemnify and hold SCILLC and its officers, employees, subsidiaries, affiliates, and distributors harmless against all claims, costs, damages, and expenses, and reasonable attorney fees arising out of, directly or indirectly, any claim of personal injury or death associated with such unintended or unauthorized use, even if such claim alleges that SCILLC was negligent regarding the design or manufacture of the part. SCILLC is an Equal Opportunity/Affirmative Action Employer. This literature is subject to all applicable copyright laws and is not for resale in any manner.

### PUBLICATION ORDERING INFORMATION

LITERATURE FULFILLMENT:

Literature Distribution Center for ON Semiconductor  
P.O. Box 5163, Denver, Colorado 80217 USA  
Phone: 303-675-2175 or 800-344-3860 Toll Free USA/Canada  
Fax: 303-675-2176 or 800-344-3867 Toll Free USA/Canada  
Email: [orderlit@onsemi.com](mailto:orderlit@onsemi.com)

N. American Technical Support: 800-282-9855 Toll Free  
USA/Canada  
Europe, Middle East and Africa Technical Support:  
Phone: 421 33 790 2910  
Japan Customer Focus Center  
Phone: 81-3-5817-1050

ON Semiconductor Website: [www.onsemi.com](http://www.onsemi.com)

Order Literature: <http://www.onsemi.com/orderlit>

For additional information, please contact your local Sales Representative