



Chipsmall Limited consists of a professional team with an average of over 10 year of expertise in the distribution of electronic components. Based in Hongkong, we have already established firm and mutual-benefit business relationships with customers from,Europe,America and south Asia,supplying obsolete and hard-to-find components to meet their specific needs.

With the principle of “Quality Parts,Customers Priority,Honest Operation,and Considerate Service”,our business mainly focus on the distribution of electronic components. Line cards we deal with include Microchip,ALPS,ROHM,Xilinx,Pulse,ON,Everlight and Freescale. Main products comprise IC,Modules,Potentiometer,IC Socket,Relay,Connector.Our parts cover such applications as commercial,industrial, and automotives areas.

We are looking forward to setting up business relationship with you and hope to provide you with the best service and solution. Let us make a better world for our industry!



## Contact us

Tel: +86-755-8981 8866 Fax: +86-755-8427 6832

Email & Skype: info@chipsmall.com Web: www.chipsmall.com

Address: A1208, Overseas Decoration Building, #122 Zhenhua RD., Futian, Shenzhen, China



## Low Voltage 2.5/3.3 V Differential ECL/PECL/HSTL Fanout Buffer

The MC100ES6210 is a bipolar monolithic differential clock fanout buffer. Designed for most demanding clock distribution systems, the MC100ES6210 supports various applications that require to distribute precisely aligned differential clock signals. Using SiGe technology and a fully differential architecture, the device offers very low clock skew outputs and superior digital signal characteristics. Target applications for this clock driver is high performance clock distribution in computing, networking and telecommunication systems.

### Features

- Dual 1:5 differential clock distribution
- 30 ps maximum device skew
- Fully differential architecture from input to all outputs
- SiGe technology supports near-zero output skew
- Supports DC to 3 GHz operation of clock or data signals
- ECL/PECL compatible differential clock outputs
- ECL/PECL compatible differential clock inputs
- Single 3.3 V, -3.3 V, 2.5 V or -2.5 V supply
- Standard 32 lead LQFP package
- Industrial temperature range
- Pin and function compatible to the MC100EP210
- 32-lead Pb-free Package Available

### Functional Description

The MC100ES6210 is designed for low skew clock distribution systems and supports clock frequencies up to 3 GHz. The device consists of two independent 1:5 clock fanout buffers. The input signal of each fanout buffer is distributed to five identical, differential ECL/PECL outputs. Both CLKA and CLKB inputs can be driven by ECL/PECL compatible signals.

If  $V_{BB}$  is connected to the CLKA or CLKB input and bypassed to GND by a 10 nF capacitor, the MC100ES6210 can be driven by single-ended ECL/PECL signals utilizing the  $V_{BB}$  bias voltage output.

In order to meet the tight skew specification of the device, both outputs of a differential output pair should be terminated, even if only one output is used. In the case where not all ten outputs are used, the output pairs on the same package side as the parts being used on that side should be terminated.

The MC100ES6210 can be operated from a single 3.3 V or 2.5 V supply. As most other ECL compatible devices, the MC100ES6210 supports positive (PECL) and negative (ECL) supplies. The is function and pin compatible to the MC100EP210.

**MC100ES6210**

**LOW VOLTAGE DUAL  
1:5 DIFFERENTIAL PECL/ECL/HSTL  
CLOCK FANOUT BUFFER**



**FA SUFFIX  
32-LEAD LQFP PACKAGE  
CASE 873A-03**



**AC SUFFIX  
32-LEAD LQFP PACKAGE  
Pb-FREE PACKAGE  
CASE 873A-03**

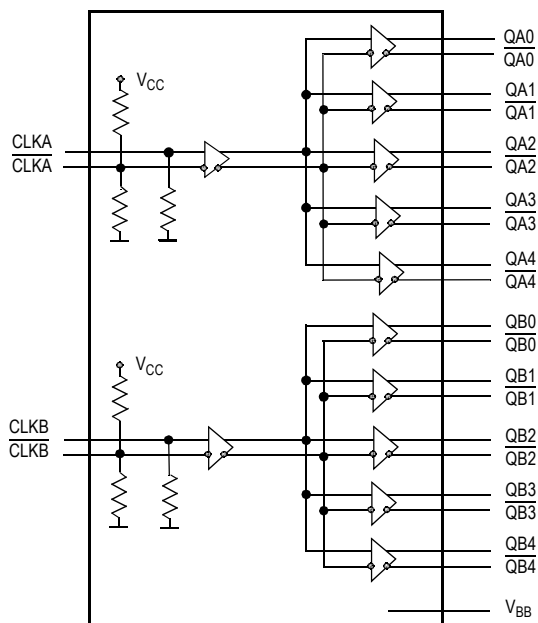


Figure 1. MC100ES6210 Logic Diagram

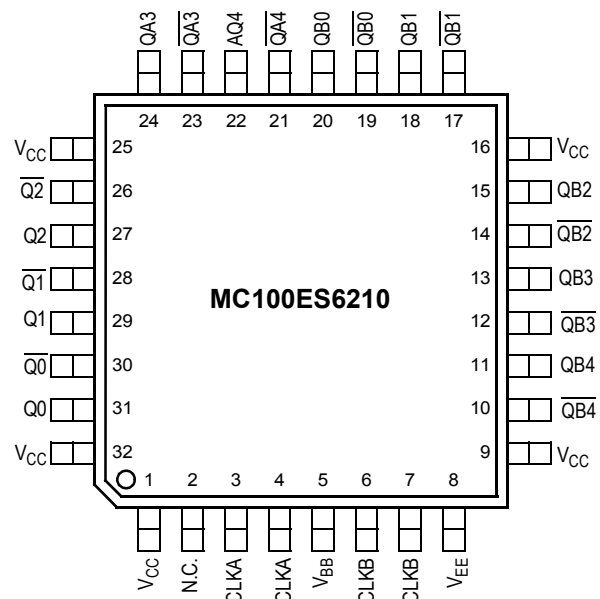


Figure 2. 32-Lead Package Pinout (Top View)

Table 1. Pin Configuration

Pin	I/O	Type	Function
CLKA, CLKA	Input	ECL/PECL	Differential reference clock signal input (fanout buffer A)
CLKB, CLKB	Input	ECL/PECL	Differential reference clock signal input (fanout buffer B)
QA[0-4], QA[0-4]	Output	ECL/PECL	Differential clock outputs (fanout buffer A)
QB[0-4], QB[0-4]	Output	ECL/PECL	Differential clock outputs (fanout buffer B)
V <sub>EE</sub> <sup>(1)</sup>	Supply		Negative power supply
V <sub>CC</sub>	Supply		Positive power supply. All V <sub>CC</sub> pins must be connected to the positive power supply for correct DC and AC operation.
V <sub>BB</sub>	Output	DC	Reference voltage output for single ended ECL or PECL operation

1. In ECL mode (negative power supply mode), V<sub>EE</sub> is either -3.3 V or -2.5 V and V<sub>CC</sub> is connected to GND (0 V). In PECL mode (positive power supply mode), V<sub>EE</sub> is connected to GND (0 V) and V<sub>CC</sub> is either +3.3 V or +2.5 V. In both modes, the input and output levels are referenced to the most positive supply (V<sub>CC</sub>)

Table 2. Absolute Maximum Ratings<sup>(1)</sup>

Symbol	Characteristics	Min	Max	Unit	Condition
V <sub>CC</sub>	Supply Voltage	-0.3	3.6	V	
V <sub>IN</sub>	DC Input Voltage	-0.3	V <sub>CC</sub> + 0.3	V	
V <sub>OUT</sub>	DC Output Voltage	-0.3	V <sub>CC</sub> + 0.3	V	
I <sub>IN</sub>	DC Input Current		±20	mA	
I <sub>OUT</sub>	DC Output Current		±50	mA	
T <sub>S</sub>	Storage temperature	-65	125	°C	

1. Absolute maximum continuous ratings are those maximum values beyond which damage to the device may occur. Exposure to these conditions or conditions beyond those indicated may adversely affect device reliability. Functional operation at absolute-maximum-rated conditions is not implied.

**Table 3. General Specifications**

Symbol	Characteristics	Min	Typ	Max	Unit	Condition
$V_{TT}$	Output Termination Voltage		$V_{CC} - 2^{(1)}$		V	
MM	ESD Protection (Machine Model)	200			V	
HBM	ESD Protection (Human Body Model)	2000			V	
CDM	ESD Protection (Charged Device Model)				V	
LU	Latch-Up Immunity	200			mA	
$C_{IN}$	Input Capacitance		4.0		pF	Inputs
$\theta_{JA}$	Thermal Resistance Junction to Ambient JESD 51-3, single layer test board		83.1 73.3 68.9 63.8 57.4	86.0 75.4 70.9 65.3 59.6	$^{\circ}\text{C}/\text{W}$ $^{\circ}\text{C}/\text{W}$ $^{\circ}\text{C}/\text{W}$ $^{\circ}\text{C}/\text{W}$ $^{\circ}\text{C}/\text{W}$	Natural convection 100 ft/min 200 ft/min 400 ft/min 800 ft/min
	JESD 51-6, 2S2P multilayer test board		59.0 54.4 52.5 50.4 47.8	60.6 55.7 53.8 51.5 48.8	$^{\circ}\text{C}/\text{W}$ $^{\circ}\text{C}/\text{W}$ $^{\circ}\text{C}/\text{W}$ $^{\circ}\text{C}/\text{W}$ $^{\circ}\text{C}/\text{W}$	Natural convection 100 ft/min 200 ft/min 400 ft/min 800 ft/min
$\theta_{JC}$	Thermal Resistance Junction to Case		23.0	26.3	$^{\circ}\text{C}/\text{W}$	MIL-SPEC 883E Method 1012.1
$T_J$	Operating Junction Temperature <sup>(2)</sup> (continuous operation) MTBF = 9.1 years			110	$^{\circ}\text{C}$	

1. Output termination voltage  $V_{TT} = 0\text{ V}$  for  $V_{CC} = 2.5\text{ V}$  operation is supported but the power consumption of the device will increase.
2. Operating junction temperature impacts device life time. Maximum continuous operating junction temperature should be selected according to the application life time requirements (See application note AN1545 for more information). The device AC and DC parameters are specified up to  $110^{\circ}\text{C}$  junction temperature allowing the MC100ES6210 to be used in applications requiring industrial temperature range. It is recommended that users of the MC100ES6210 employ thermal modeling analysis to assist in applying the junction temperature specifications to their particular application.

**Table 4. PECL DC Characteristics** ( $V_{CC} = 2.5\text{ V} \pm 5\%$  or  $V_{CC} = 3.3\text{ V} \pm 5\%$ ,  $V_{EE} = \text{GND}$ ,  $T_J = 0^{\circ}\text{C}$  to  $+110^{\circ}\text{C}$ )

Symbol	Characteristics	Min	Typ	Max	Unit	Condition
Clock Input Pair CLKA, $\overline{\text{CLKA}}$ , CLKB, $\overline{\text{CLKB}}$ (PECL differential signals)						
$V_{PP}$	Differential Input Voltage <sup>(1)</sup>	0.1		1.3	V	Differential operation
$V_{CMR}$	Differential Cross Point Voltage <sup>(2)</sup>	1.0		$V_{CC} - 0.3$	V	Differential operation
$I_{IN}$	Input Current <sup>(1)</sup>			$\pm 100$	$\mu\text{A}$	$V_{IN} = V_{IL}$ or $V_{IN} = V_{IH}$
PECL Clock Outputs (QA0-4, $\overline{\text{QA0-4}}$ , QB0-4, $\overline{\text{QB0-4}}$ )						
$V_{OH}$	Output High Voltage	$V_{CC} - 1.2$	$V_{CC} - 1.005$	$V_{CC} - 0.7$	V	$I_{OH} = -30\text{ mA}^{(3)}$
$V_{OL}$	Output Low Voltage	$V_{CC} - 1.9$ $V_{CC} - 1.9$	$V_{CC} - 1.705$ $V_{CC} - 1.705$	$V_{CC} - 1.5$ $V_{CC} - 1.3$	V	$I_{OL} = -5\text{ mA}^{(3)}$
Supply Current and $V_{BB}$						
$I_{EE}$	Maximum Quiescent Supply Current without Output Termination Current		60	100	mA	$V_{EE}$ pin
$V_{BB}$	Output Reference Voltage	$V_{CC} - 1.38$	$V_{CC} - 1.26$	$V_{CC} - 1.14$	V	$I_{BB} = 0.2\text{ mA}$

1.  $V_{PP}$  (DC) is the minimum differential input voltage swing required to maintain device functionality.
2.  $V_{CMR}$  (DC) is the crosspoint of the differential input signal. Functional operation is obtained when the crosspoint is within the  $V_{CMR}$  (DC) range and the input swing lies within the  $V_{PP}$  (DC) specification.
3. Equivalent to a termination of  $50\ \Omega$  to  $V_{TT}$ .

**Table 5. ECL DC Characteristics** ( $V_{EE} = -2.5\text{ V} \pm 5\%$  or  $V_{EE} = -3.3\text{ V} \pm 5\%$ ,  $V_{CC} = \text{GND}$ ,  $T_J = 0^\circ\text{C}$  to  $+110^\circ\text{C}$ )

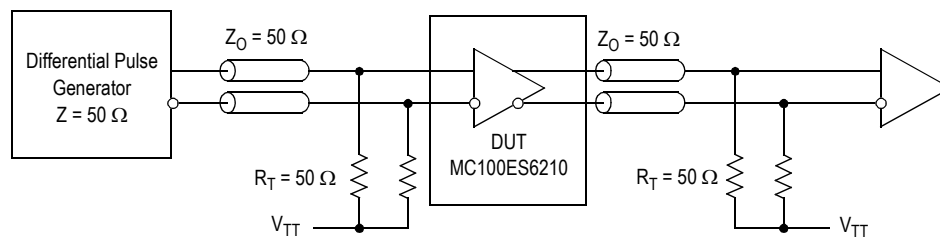
Symbol	Characteristics	Min	Typ	Max	Unit	Condition
Clock Input Pair $\overline{\text{CLKA}}$ , $\overline{\text{CLKA}}$ , $\overline{\text{CLKB}}$ , $\overline{\text{CLKB}}$ (ECL differential signals)						
$V_{PP}$	Differential Input Voltage <sup>(1)</sup>	0.1		1.3	V	Differential operation
$V_{CMR}$	Differential Cross Point Voltage <sup>(2)</sup>	$V_{EE} + 1.0$		-0.3	V	Differential operation
$I_{IN}$	Input Current <sup>(1)</sup>			$\pm 100$	$\mu\text{A}$	$V_{IN} = V_{IL}$ or $V_{IN} = V_{IH}$
ECL Clock Outputs ( $\overline{\text{QA0-4}}$ , $\overline{\text{QA0-4}}$ , $\overline{\text{QB0-4}}$ , $\overline{\text{QB0-4}}$ )						
$V_{OH}$	Output High Voltage	-1.2	-1.005	-0.7	V	$I_{OH} = -30\text{ mA}^{(3)}$
$V_{OL}$	Output Low Voltage	-1.9	-1.705	-1.5	V	$I_{OL} = -5\text{ mA}^{(3)}$
	$V_{CC} = 3.3\text{ V} \pm 5\%$ $V_{CC} = 2.5\text{ V} \pm 5\%$	-1.9	-1.705	-1.3		
Supply Current and $V_{BB}$						
$I_{EE}$	Maximum Quiescent Supply Current without Output Termination Current		60	100	mA	$V_{EE}$ pin
$V_{BB}$	Output Reference Voltage	-1.38	-1.26	-1.14	V	$I_{BB} = 0.2\text{ mA}$

- $V_{PP}$  (DC) is the minimum differential input voltage swing required to maintain device functionality.
- $V_{CMR}$  (DC) is the crosspoint of the differential input signal. Functional operation is obtained when the crosspoint is within the  $V_{CMR}$  (DC) range and the input swing lies within the  $V_{PP}$  (DC) specification.
- Equivalent to a termination of  $50\ \Omega$  to  $V_{TT}$ .

**Table 6. AC Characteristics** (ECL:  $V_{EE} = -3.3\text{ V} \pm 5\%$  or  $V_{EE} = -2.5\text{ V} \pm 5\%$ ,  $V_{CC} = \text{GND}$ ) or  
(PECL:  $V_{CC} = 3.3\text{ V} \pm 5\%$  or  $V_{CC} = 2.5\text{ V} \pm 5\%$ ,  $V_{EE} = \text{GND}$ ,  $T_J = 0^\circ\text{C}$  to  $+110^\circ\text{C}$ )<sup>(1)</sup> <sup>(2)</sup>

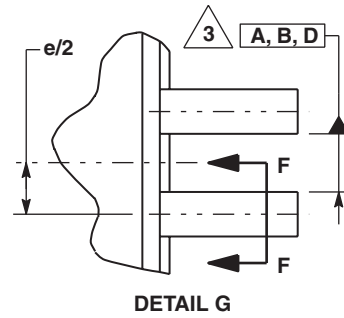
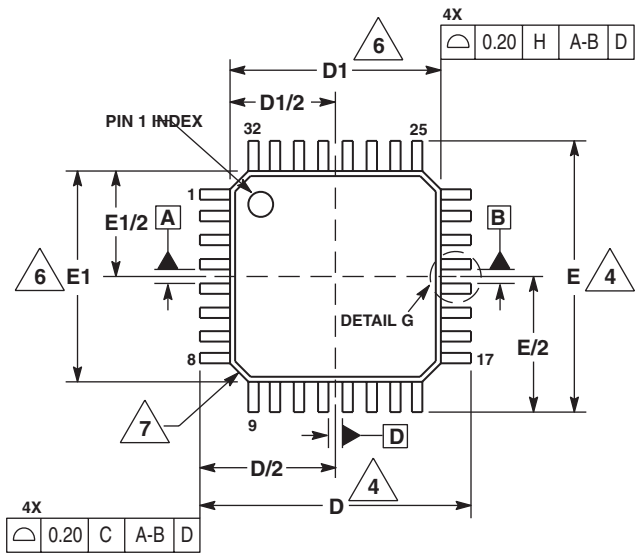
Symbol	Characteristics	Min	Typ	Max	Unit	Condition
Clock Input Pair CLKA, CLKA, CLKB, CLKB (PECL or ECL differential signals)						
$V_{PP}$	Differential Input Voltage <sup>(3)</sup> (peak-to-peak)	0.3	0.3	1.3	V	
$V_{CMR}$	Differential Input Crosspoint Voltage <sup>(4)</sup>	PECL	1.2	$V_{CC} - 0.3$ $-0.3\text{ V}$	V	
		ECL	$V_{EE} + 1.2$		V	
ECL Clock Outputs (Q0–9, Q0–9)						
$f_{CLK}$	Input Frequency	0		3000	MHz	Differential
$t_{PD}$	Propagation Delay CLKA to QAx or CLKB to QBx	175	260	350	ps	Differential
$V_{O(P-P)}$	Differential Output Voltage (peak-to-peak)	$f_O < 1.1\text{ GHz}$	0.45	0.70	V	
		$f_O < 2.5\text{ GHz}$	0.35	0.55	V	
		$f_O < 3.0\text{ GHz}$	0.20	0.35	V	
$t_{sk(O)}$	Output-to-Output Skew (per bank)		13	30	ps	Differential
$t_{sk(PP)}$	Output-to-Output Skew (part-to-part)			175	ps	Differential
$t_{JIT(CC)}$	Output Cycle-to-Cycle Jitter			1	ps	
$t_{SK(P)}$	Output Pulse Skew <sup>(5)</sup>			50	ps	
$DC_Q$	Output Duty Cycle	$f_{REF} < 0.1\text{ GHz}$	49.5	50	%	$DC_{REF} = 50\%$
		$f_{REF} < 1.0\text{ GHz}$	45.0	50	%	$DC_{REF} = 50\%$
$t_r, t_f$	Output Rise/Fall Time	30		250	ps	20% to 80%

1. AC characteristics are design targets and pending characterization.
2. AC characteristics apply for parallel output termination of  $50\ \Omega$  to  $V_{TT}$ .
3.  $V_{PP}$  (AC) is the minimum differential ECL/PECL input voltage swing required to maintain AC characteristics including  $t_{PD}$  and device-to-device skew.
4.  $V_{CMR}$  (AC) is the crosspoint of the differential ECL/PECL input signal. Normal AC operation is obtained when the crosspoint is within the  $V_{CMR}$  (AC) range and the input swing lies within the  $V_{PP}$  (AC) specification. Violation of  $V_{CMR}$  (AC) or  $V_{PP}$  (AC) impacts the device propagation delay, device and part-to-part skew.
5. Output pulse skew is the absolute difference of the propagation delay times:  $|t_{PLH} - t_{PHL}|$ .

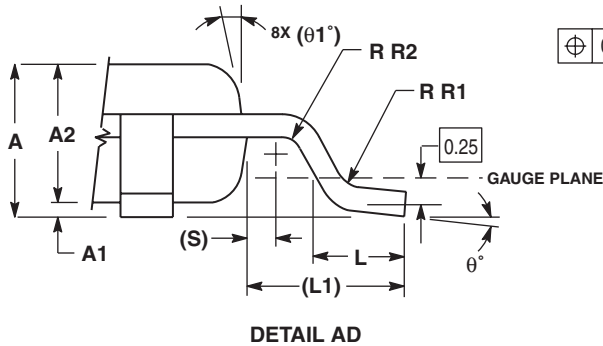
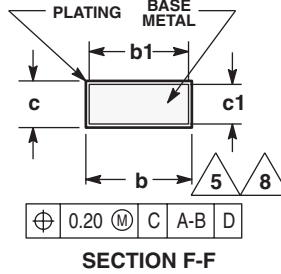
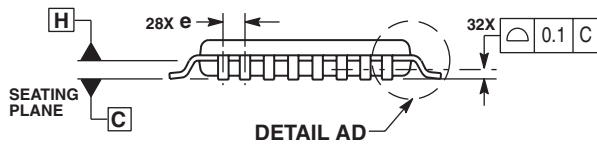


**Figure 3. MC100ES6210 AC Test Reference**

# PACKAGE DIMENSIONS



- NOTES:
1. DIMENSIONS ARE IN MILLIMETERS.
  2. INTERPRET DIMENSIONS AND TOLERANCES PER ASME Y14.5M, 1994.
  3. DATUMS A, B, AND D TO BE DETERMINED AT DATUM PLANE H.
  4. DIMENSIONS D AND E TO BE DETERMINED AT SEATING PLANE C.
  5. DIMENSION b DOES NOT INCLUDE DAMBAR PROTRUSION. ALLOWABLE DAMBAR PROTRUSION SHALL NOT CAUSE THE LEAD WIDTH TO EXCEED THE MAXIMUM b DIMENSION BY MORE THAN 0.08-mm. DAMBAR CANNOT BE LOCATED ON THE LOWER RADIUS OR THE FOOT. MINIMUM SPACE BETWEEN PROTRUSION AND ADJACENT LEAD OR PROTRUSION: 0.07-mm.
  6. DIMENSIONS D1 AND E1 DO NOT INCLUDE MOLD PROTRUSION. ALLOWABLE PROTRUSION IS 0.25-mm PER SIDE. D1 AND E1 ARE MAXIMUM PLASTIC BODY SIZE DIMENSIONS INCLUDING MOLD MISMATCH.
  7. EXACT SHAPE OF EACH CORNER IS OPTIONAL. THESE DIMENSIONS APPLY TO THE FLAT SECTION OF THE LEAD BETWEEN 0.1-mm AND 0.25-mm FROM THE LEAD TIP.



DIM	MILLIMETERS	
	MIN	MAX
A	1.40	1.60
A1	0.05	0.15
A2	1.35	1.45
b	0.30	0.45
b1	0.30	0.40
c	0.09	0.20
c1	0.09	0.16
D	9.00 BSC	
D1	7.00 BSC	
e	0.80 BSC	
E	9.00 BSC	
E1	7.00 BSC	
L	0.50	0.70
L1	1.00 REF	
q	0°	7°
q1	12 REF	
R1	0.08	0.20
R2	0.08	---
S	0.20 REF	

## CASE 873A-03 ISSUE B 32-LEAD LQFP PACKAGE

---

# NOTES



## **How to Reach Us:**

### **Home Page:**

www.freescale.com

### **E-mail:**

support@freescale.com

### **USA/Europe or Locations Not Listed:**

Freescale Semiconductor  
Technical Information Center, CH370  
1300 N. Alma School Road  
Chandler, Arizona 85224  
+1-800-521-6274 or +1-480-768-2130  
support@freescale.com

### **Europe, Middle East, and Africa:**

Freescale Halbleiter Deutschland GmbH  
Technical Information Center  
Schatzbogen 7  
81829 Muenchen, Germany  
+44 1296 380 456 (English)  
+46 8 52200080 (English)  
+49 89 92103 559 (German)  
+33 1 69 35 48 48 (French)  
support@freescale.com

### **Japan:**

Freescale Semiconductor Japan Ltd.  
Headquarters  
ARCO Tower 15F  
1-8-1, Shimo-Meguro, Meguro-ku,  
Tokyo 153-0064  
Japan  
0120 191014 or +81 3 5437 9125  
support.japan@freescale.com

### **Asia/Pacific:**

Freescale Semiconductor Hong Kong Ltd.  
Technical Information Center  
2 Dai King Street  
Tai Po Industrial Estate  
Tai Po, N.T., Hong Kong  
+800 2666 8080  
support.asia@freescale.com

### **For Literature Requests Only:**

Freescale Semiconductor Literature Distribution Center  
P.O. Box 5405  
Denver, Colorado 80217  
1-800-441-2447 or 303-675-2140  
Fax: 303-675-2150  
LDCForFreescaleSemiconductor@hibbertgroup.com

Information in this document is provided solely to enable system and software implementers to use Freescale Semiconductor products. There are no express or implied copyright licenses granted hereunder to design or fabricate any integrated circuits or integrated circuits based on the information in this document.

Freescale Semiconductor reserves the right to make changes without further notice to any products herein. Freescale Semiconductor makes no warranty, representation or guarantee regarding the suitability of its products for any particular purpose, nor does Freescale Semiconductor assume any liability arising out of the application or use of any product or circuit, and specifically disclaims any and all liability, including without limitation consequential or incidental damages. "Typical" parameters that may be provided in Freescale Semiconductor data sheets and/or specifications can and do vary in different applications and actual performance may vary over time. All operating parameters, including "Typicals", must be validated for each customer application by customer's technical experts. Freescale Semiconductor does not convey any license under its patent rights nor the rights of others. Freescale Semiconductor products are not designed, intended, or authorized for use as components in systems intended for surgical implant into the body, or other applications intended to support or sustain life, or for any other application in which the failure of the Freescale Semiconductor product could create a situation where personal injury or death may occur. Should Buyer purchase or use Freescale Semiconductor products for any such unintended or unauthorized application, Buyer shall indemnify and hold Freescale Semiconductor and its officers, employees, subsidiaries, affiliates, and distributors harmless against all claims, costs, damages, and expenses, and reasonable attorney fees arising out of, directly or indirectly, any claim of personal injury or death associated with such unintended or unauthorized use, even if such claim alleges that Freescale Semiconductor was negligent regarding the design or manufacture of the part.

Freescale™ and the Freescale logo are trademarks of Freescale Semiconductor, Inc. All other product or service names are the property of their respective owners.

© Freescale Semiconductor, Inc. 2005. All rights reserved.