



Chipsmall Limited consists of a professional team with an average of over 10 year of expertise in the distribution of electronic components. Based in Hongkong, we have already established firm and mutual-benefit business relationships with customers from,Europe,America and south Asia,supplying obsolete and hard-to-find components to meet their specific needs.

With the principle of “Quality Parts,Customers Priority,Honest Operation,and Considerate Service”,our business mainly focus on the distribution of electronic components. Line cards we deal with include Microchip,ALPS,ROHM,Xilinx,Pulse,ON,Everlight and Freescale. Main products comprise IC,Modules,Potentiometer,IC Socket,Relay,Connector.Our parts cover such applications as commercial,industrial, and automotives areas.

We are looking forward to setting up business relationship with you and hope to provide you with the best service and solution. Let us make a better world for our industry!



## Contact us

Tel: +86-755-8981 8866 Fax: +86-755-8427 6832

Email & Skype: info@chipsmall.com Web: www.chipsmall.com

Address: A1208, Overseas Decoration Building, #122 Zhenhua RD., Futian, Shenzhen, China



## Low Voltage Dual 1:10 Differential ECL/PECL Clock Fanout Buffer

The MC100ES6220 is a bipolar monolithic differential clock fanout buffer. Designed for most demanding clock distribution systems, the MC100ES6220 supports various applications that require the distribution of precisely aligned differential clock signals. Using SiGe technology and a fully differential architecture, the device offers very low skew outputs and superior digital signal characteristics. Target applications for this clock driver are high performance clock distribution in computing, networking and telecommunication systems.

### Features

- Two independent 1:10 differential clock fanout buffers
- 130 ps maximum device skew
- SiGe technology
- Supports DC to 1 GHz operation of clock or data signals
- ECL/PECL compatible differential clock outputs
- ECL/PECL compatible differential clock inputs
- Single 3.3 V, -3.3 V, 2.5 V or -2.5 V supply
- Standard 52-lead LQFP package with exposed pad for enhanced thermal characteristics
- Supports industrial temperature range
- Pin and function compatible to the MC100EP220
- 52-lead Pb-free Package Available

### Functional Description

The MC100ES6220 is designed for low skew clock distribution systems and supports clock frequencies up to 1 GHz. The device consists of two independent clock fanout buffers. The CLKA and CLKB inputs can be driven by ECL or PECL compatible signals. The input signal of each clock buffer is distributed to 10 identical, differential ECL/PECL outputs. If  $V_{BB}$  is connected to the CLKA or CLKB input and bypassed to GND by a 10 nF capacitor, the MC100ES6220 can be driven by single-ended ECL/PECL signals utilizing the  $V_{BB}$  bias voltage output.

In order to meet the tight skew specification of the device, both outputs of a differential output pair should be terminated, even if only one output is used. In the case where not all ten outputs are used, the output pairs on the same package side as the parts being used on that side should be terminated.

The MC100ES6220 can be operated from a single 3.3 V or 2.5 V supply. As most other ECL compatible devices, the MC100ES6220 supports positive (PECL) and negative (ECL) supplies. The MC100ES6220 is pin and function compatible to the MC100EP220.

**MC100ES6220**

**LOW VOLTAGE DUAL  
1:10 DIFFERENTIAL ECL/PECL  
CLOCK FANOUT BUFFER**



**TB SUFFIX  
52-LEAD LQFP PACKAGE  
EXPOSED PAD  
CASE 1336A-01**

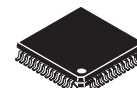

**AE SUFFIX  
52-LEAD LQFP PACKAGE  
Pb-FREE PACKAGE  
CASE 1336A-01**

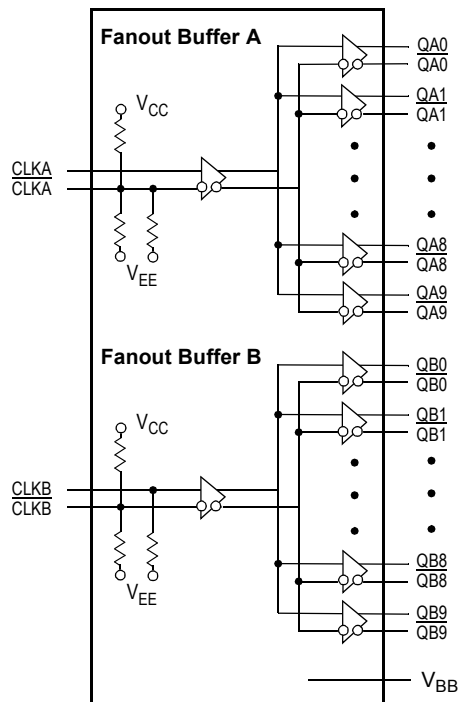

Figure 1. MC100ES6220 Logic Diagram

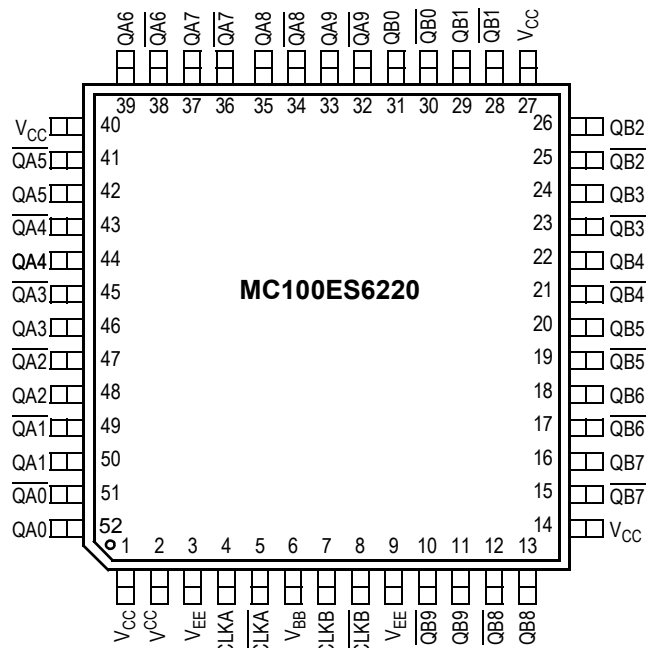

Figure 2. 52-Lead Package Pinout (Top View)

Table 1. Pin Configuration

Pin	I/O	Type	Function
CLKA, CLKA	Input	ECL/PECL	Differential reference clock signal input for fanout buffer A
CLKB, CLKB	Input	ECL/PECL	Differential reference clock signal input for fanout buffer B
QA[0-9], QA[0-9]	Output	ECL/PECL	Differential clock outputs of fanout buffer A
QB[0-9], QB[0-9]	Output	ECL/PECL	Differential clock outputs of fanout buffer B
$V_{EE}^{(1)}$	Supply		Negative power supply
$V_{CC}$	Supply		Positive power supply. All $V_{CC}$ pins must be connected to the positive power supply for correct DC and AC operation.
$V_{BB}$	Output	DC	Reference voltage output for single ended ECL and PECL operation

1. In ECL mode (negative power supply mode),  $V_{EE}$  is either  $-3.3$  V or  $-2.5$  V and  $V_{CC}$  is connected to GND (0 V). In PECL mode (positive power supply mode),  $V_{EE}$  is connected to GND (0 V) and  $V_{CC}$  is either  $+3.3$  V or  $+2.5$  V. In both modes, the input and output levels are referenced to the most positive supply ( $V_{CC}$ ).

**Table 2. Absolute Maximum Ratings<sup>(1)</sup>**

Symbol	Characteristics	Min	Max	Unit	Condition
V <sub>CC</sub>	Supply Voltage	-0.3	3.6	V	
V <sub>IN</sub>	DC Input Voltage	-0.3	V <sub>CC</sub> + 0.3	V	
V <sub>OUT</sub>	DC Output Voltage	-0.3	V <sub>CC</sub> + 0.3	V	
I <sub>IN</sub>	DC Input Current		±20	mA	
I <sub>OUT</sub>	DC Output Current		±50	mA	
T <sub>S</sub>	Storage Temperature	-65	125	°C	
T <sub>FUNC</sub>	Functional Temperature Range	T <sub>A</sub> = -40	T <sub>J</sub> = +110	°C	

1. Absolute maximum continuous ratings are those maximum values beyond which damage to the device may occur. Exposure to these conditions or conditions beyond those indicated may adversely affect device reliability. Functional operation at absolute-maximum-rated conditions is not implied.

**Table 3. General Specifications**

Symbol	Characteristics	Min	Typ	Max	Unit	Condition
V <sub>TT</sub>	Output Termination Voltage		V <sub>CC</sub> - 2 <sup>(1)</sup>		V	
MM	ESD Protection (Machine Model)	200			V	
HBM	ESD Protection (Human Body Model)	4000			V	
CDM	ESD Protection (Charged Device Model)	2000			V	
LU	Latch-Up Immunity	200			mA	
C <sub>IN</sub>	Input Capacitance		4.0		pF	Inputs
θ <sub>JA</sub> , θ <sub>JC</sub> , θ <sub>JB</sub>	Thermal Resistance (junction-to-ambient, junction-to-board, junction-to-case)	See <a href="#">Table 8. Thermal Resistance</a>			°C/W	
T <sub>J</sub>	Operating Junction Temperature <sup>(2)</sup> (continuous operation) MTBF = 9.1 years	0		110	°C	

1. Output termination voltage V<sub>TT</sub> = 0 V for V<sub>CC</sub> = 2.5 V operation is supported but the power consumption of the device will increase.
2. Operating junction temperature impacts device life time. Maximum continuous operating junction temperature should be selected according to the application life time requirements (See application note AN1545 for more information). The device AC and DC parameters are specified up to 110°C junction temperature allowing the MC100ES6220 to be used in applications requiring industrial temperature range. It is recommended that users of the MC100ES6220 employ thermal modeling analysis to assist in applying the junction temperature specifications to their particular application.

**Table 4. PECL DC Characteristics** ( $V_{CC} = 2.5\text{ V} \pm 5\%$  or  $V_{CC} = 3.3\text{ V} \pm 5\%$ ,  $V_{EE} = \text{GND}$ ,  $T_J = 0^\circ\text{C}$  to  $+110^\circ\text{C}$ )

Symbol	Characteristics	Min	Typ	Max	Unit	Condition
Clock Input Pair $\overline{\text{CLKA}}$ , $\overline{\text{CLKA}}$ , $\overline{\text{CLKB}}$ , $\overline{\text{CLKB}}$ (PECL differential signals)						
$V_{PP}$	Differential Input Voltage <sup>(1)</sup>	0.1		1.3	V	Differential operation
$V_{CMR}$	Differential Cross Point Voltage <sup>(2)</sup>	1.0		$V_{CC} - 0.3$	V	Differential operation
$I_{IN}$	Input Current <sup>(1)</sup>			$\pm 150$	$\mu\text{A}$	$V_{IN} = V_{IL}$ or $V_{IN} = V_{IH}$
Clock Inputs (PECL single ended signals)						
$V_{IH}$	Input Voltage High	$V_{CC} - 1.165$		$V_{CC} - 0.880$	V	
$V_{IL}$	Input Voltage Low	$V_{CC} - 1.810$		$V_{CC} - 1.475$	V	
$I_{IN}$	Input Current <sup>(3)</sup>			$\pm 150$	$\mu\text{A}$	$V_{IN} = V_{IL}$ or $V_{IN} = V_{IH}$
PECL Clock Outputs ( $\overline{\text{QA0-A9}}$ , $\overline{\text{QA0-A9}}$ , $\overline{\text{QB0-B9}}$ , $\overline{\text{QB0-B9}}$ )						
$V_{OH}$	Output High Voltage	$V_{CC} - 1.1$	$V_{CC} - 1.005$	$V_{CC} - 0.7$	V	$I_{OH} = -30\text{ mA}^{(4)}$
$V_{OL}$	Output Low Voltage	$V_{CC} - 1.9$	$V_{CC} - 1.705$	$V_{CC} - 1.4$	V	$I_{OL} = -5\text{ mA}^{(4)}$
Supply current and $V_{BB}$						
$I_{EE}^{(5)}$	Maximum Quiescent Supply Current without Output Termination Current		80	130	mA	$V_{EE}$ pins
$V_{BB}$	Output Reference Voltage	$V_{CC} - 1.42$		$V_{CC} - 1.20$	V	$I_{BB} = 0.3\text{ mA}$

- $V_{PP}$  (DC) is the minimum differential input voltage swing required to maintain device functionality.
- $V_{CMR}$  (DC) is the crosspoint of the differential input signal. Functional operation is obtained when the crosspoint is within the  $V_{CMR}$  (DC) range and the input swing lies within the  $V_{PP}$  (DC) specification.
- Input have internal pullup/pulldown resistors which affect the input current.
- Termination  $50\ \Omega$  to  $V_{TT}$ .
- $I_{CC}$  calculation:  $I_{CC} = (\text{number of differential output used}) \times (I_{OH} + I_{OL}) + I_{EE}$   
 $I_{CC} = (\text{number of differential output used}) \times (V_{OH} - V_{TT}) \div R_{load} + (V_{OL} - V_{TT}) \div R_{load} + I_{EE}$ .

**Table 5. ECL DC Characteristics** ( $V_{EE} = -2.5\text{ V} \pm 5\%$  or  $V_{EE} = -3.3\text{ V} \pm 5\%$ ,  $V_{CC} = \text{GND}$ ,  $T_J = 0^\circ\text{C}$  to  $+110^\circ\text{C}$ )

Symbol	Characteristics	Min	Typ	Max	Unit	Condition
Clock Input Pair $\overline{\text{CLKA}}$ , $\overline{\text{CLKA}}$ , $\overline{\text{CLKB}}$ , $\overline{\text{CLKB}}$ (ECL differential signals)						
$V_{PP}$	Differential Input Voltage <sup>(1)</sup>	0.1		1.3	V	Differential operation
$V_{CMR}$	Differential Cross Point Voltage <sup>(2)</sup>	$V_{EE} + 1.0$		-0.3	V	Differential operation
$I_{IN}$	Input Current <sup>(1)</sup>			$\pm 150$	$\mu\text{A}$	$V_{IN} = V_{IL}$ or $V_{IN} = V_{IH}$
Clock Inputs (ECL single ended signals)						
$V_{IH}$	Input Voltage High	-1.165		-0.880	V	
$V_{IL}$	Input Voltage Low	-1.810		-1.475	V	
$I_{IN}$	Input Current <sup>(3)</sup>			$\pm 150$	$\mu\text{A}$	$V_{IN} = V_{IL}$ or $V_{IN} = V_{IH}$
ECL Clock Outputs ( $\overline{\text{QA0-A9}}$ , $\overline{\text{QA0-A9}}$ , $\overline{\text{QB0-B9}}$ , $\overline{\text{QB0-B9}}$ )						
$V_{OH}$	Output High Voltage	-1.1	-1.005	-0.7	V	$I_{OH} = -30\text{ mA}^{(4)}$
$V_{OL}$	Output Low Voltage	-1.9	-1.705	-1.4	V	$I_{OL} = -5\text{ mA}^{(4)}$
Supply Current and $V_{BB}$						
$I_{EE}^{(5)}$	Maximum Quiescent Supply Current without Output Termination Current		80	130	mA	$V_{EE}$ pins
$V_{BB}$	Output Reference Voltage	-1.42		-1.20	V	$I_{BB} = 0.3\text{ mA}$

- $V_{PP}$  (DC) is the minimum differential input voltage swing required to maintain device functionality.
- $V_{CMR}$  (DC) is the crosspoint of the differential input signal. Functional operation is obtained when the crosspoint is within the  $V_{CMR}$  (DC) range and the input swing lies within the  $V_{PP}$  (DC) specification.
- Input have internal pullup/pulldown resistors which affect the input current.
- Termination  $50\ \Omega$  to  $V_{TT}$ .
- $I_{CC}$  calculation:  $I_{CC} = (\text{number of differential output used}) \times (I_{OH} + I_{OL}) + I_{EE}$   
 $I_{CC} = (\text{number of differential output used}) \times (V_{OH} - V_{TT}) \div R_{load} + (V_{OL} - V_{TT}) \div R_{load} + I_{EE}$ .

**Table 6. AC Characteristics** (ECL:  $V_{EE} = -3.3\text{ V} \pm 5\%$  or  $V_{EE} = -2.5\text{ V} \pm 5\%$ ,  $V_{CC} = \text{GND}$ ) or  
(PECL:  $V_{CC} = 3.3\text{ V} \pm 5\%$  or  $V_{CC} = 2.5\text{ V} \pm 5\%$ ,  $V_{EE} = \text{GND}$ ,  $T_J = 0^\circ\text{C}$  to  $+110^\circ\text{C}$ )<sup>(1)</sup>

Symbol	Characteristics	Min	Typ	Max	Unit	Condition	
Clock Input Pair CLKA, CLKB, CLKB, CLKB (PECL or ECL differential signals)							
$V_{PP}$	Differential Input Voltage <sup>(2)</sup> (peak-to-peak)	0.3		1.3	V		
$V_{CMR}$	Differential Input Crosspoint Voltage <sup>(3)</sup>	PECL ECL $V_{EE} + 1.1$		$V_{CC} - 0.3$ $-0.3$	V V		
$f_{CLK}$	Input Frequency	0		1000	MHz	Differential	
PECL/ECL Clock Outputs (QA0-A9, QA0-A9, QB0-B9, QB0-B9)							
$t_{PD}$	Propagation Delay CLKx to Qx0-9	285		550	ps	Differential	
$V_{O(P-P)}$	Differential Output Voltage (peak-to-peak)	400	600		mV		
$t_{sk(O)}$	Output-to-Output Skew		60	130	ps	Differential	
$t_{sk(PP)}$	Output-to-Output Skew (part-to-part)			200	ps	Differential	
$t_{JIT(CC)}$	Output Cycle-to-Cycle Jitter RMS (1 $\sigma$ )			1	ps		
$t_{SK(P)}$	Output Pulse Skew <sup>(4)</sup>			35	ps		
$DC_O$	Output Duty Cycle	$f_{REF} < 0.1\text{ GHz}$ $f_{REF} < 1.0\text{ GHz}$	49.65 46.5	50 50	50.35 53.5	% %	$DC_{REF} = 50\%$ $DC_{REF} = 50\%$
$t_r, t_f$	Output Rise/Fall Time	50		350	ps	20% to 80%	

- AC characteristics apply for parallel output termination of  $50\ \Omega$  to  $V_{TT}$ .
- $V_{PP}$  (AC) is the minimum differential ECL/PECL input voltage swing required to maintain AC characteristics including  $t_{PD}$  and device-to-device skew.
- $V_{CMR}$  (AC) is the crosspoint of the differential ECL/PECL input signal. Normal AC operation is obtained when the crosspoint is within the  $V_{CMR}$  (AC) range and the input swing lies within the  $V_{PP}$  (AC) specification. Violation of  $V_{CMR}$  (AC) or  $V_{PP}$  (AC) impacts the device propagation delay, device and part-to-part skew.
- Output pulse skew is the absolute difference of the propagation delay times:  $|t_{pLH} - t_{pHL}|$ .

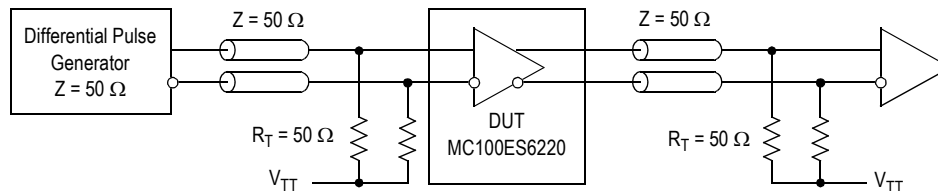

**Figure 3. MC100ES6220 AC Test Reference**

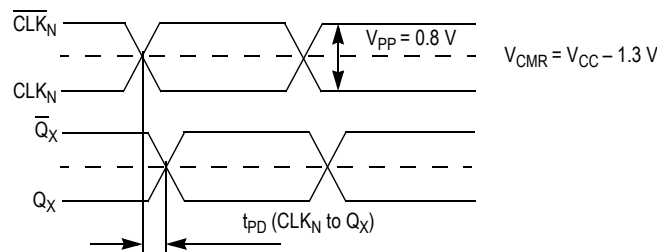

**Figure 4. MC100ES6220 AC Reference Measurement Waveform**

## APPLICATIONS INFORMATION

### Understanding the Junction Temperature Range of the MC100ES6220

To make the optimum use of high clock frequency and low skew capabilities of the MC100ES6220, the MC100ES6220 is specified, characterized and tested for the junction temperature range of  $T_J = 0^\circ\text{C}$  to  $+110^\circ\text{C}$ . Because the exact thermal performance depends on the PCB type, design, thermal management and natural or forced air convection, the junction temperature provides an exact way to correlate the application specific conditions to the published performance data of this data sheet. The correlation of the junction temperature range to the application ambient temperature range and vice versa can be done by calculation:

$$T_J = T_A + R_{thja} \cdot P_{tot}$$

Assuming a thermal resistance (junction to ambient) of  $17^\circ\text{C}/\text{W}$  (2s2p board, 200 ft/min airflow, see Table 8) and a typical power consumption of 1049 mW (all outputs terminated 50 ohms to  $V_{TT}$ ,  $V_{CC} = 3.3\text{ V}$ , frequency independent), the junction temperature of the MC100ES6220 is approximately  $T_A + 18^\circ\text{C}$ , and the minimum ambient temperature in this example case calculates to  $-18^\circ\text{C}$  (the maximum ambient temperature is  $92^\circ\text{C}$ . See Table 7). Exceeding the minimum junction temperature specification of the MC100ES6220 does not have a significant impact on the device functionality. However, the continuous use the MC100ES6220 at high ambient temperatures requires thermal management to not exceed the specified maximum junction temperature. Please see the application note AN1545 for a power consumption calculation guideline.

**Table 7. Ambient Temperature Ranges** ( $P_{tot} = 1049\text{ mW}$ )

$R_{thja}$ (2s2p board)		$T_{A, \min}^{(1)}$	$T_{A, \max}$
Natural convection	$20^\circ\text{C}/\text{W}$	$-21^\circ\text{C}$	$89^\circ\text{C}$
100 ft/min	$18^\circ\text{C}/\text{W}$	$-19^\circ\text{C}$	$91^\circ\text{C}$
200 ft/min	$17^\circ\text{C}/\text{W}$	$-18^\circ\text{C}$	$92^\circ\text{C}$
400 ft/min	$16^\circ\text{C}/\text{W}$	$-17^\circ\text{C}$	$93^\circ\text{C}$
800 ft/min	$15^\circ\text{C}/\text{W}$	$-16^\circ\text{C}$	$94^\circ\text{C}$

- The MC100ES6220 device function is guaranteed from  $T_A = -40^\circ\text{C}$  to  $T_J = 110^\circ\text{C}$ .

### Maintaining Lowest Device Skew

The MC100ES6220 guarantees low output-to-output bank skew of 100 ps and a part-to-part skew of max. 200 ps. To ensure low skew clock signals in the application, both outputs of any differential output pair need to be terminated identically, even if only one output is used. When fewer than all nine output pairs are used, identical termination of all output pairs within the output bank is recommended. This will reduce the device power consumption while maintaining minimum output skew.

### Power Supply Bypassing

The MC100ES6220 is a mixed analog/digital product. The differential architecture of the MC100ES6220 supports low noise signal operation at high frequencies. In order to maintain its superior signal quality, all  $V_{CC}$  pins should be bypassed by high-frequency ceramic capacitors connected to GND. If the spectral frequencies of the internally generated switching noise on the supply pins cross the series resonant point of an individual bypass capacitor, its overall impedance begins to look inductive and thus increases with increasing frequency. The parallel capacitor combination shown ensures that a low impedance path to ground exists for frequencies well above the noise bandwidth.

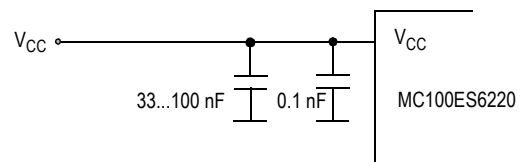
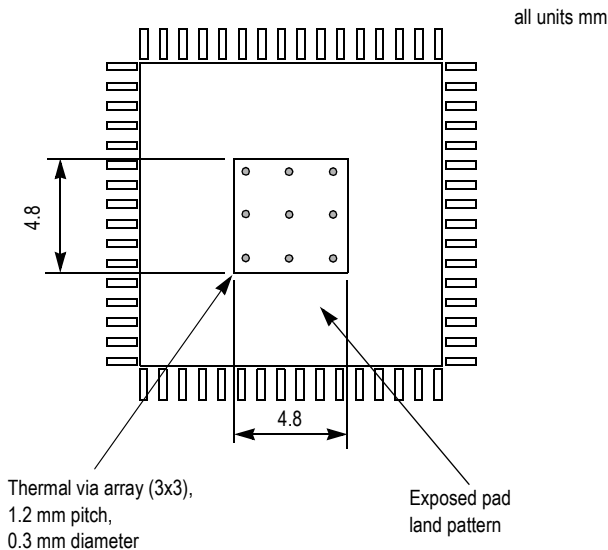

**Figure 5.  $V_{CC}$  Power Supply Bypass**

## APPLICATIONS INFORMATION

### Using the Thermally Enhanced Package of the MC100ES6220

The MC100ES6220 uses a thermally enhanced exposed pad (EP) 52 lead LQFP package. The package is molded so that the lead frame is exposed at the surface of the package bottom side. The exposed metal pad will provide the low thermal impedance that supports the power consumption of the MC100ES6220 high-speed bipolar integrated circuit and eases the power management task for the system design. A thermal land pattern on the printed circuit board and thermal vias are recommended in order to take advantage of the enhanced thermal capabilities of the MC100ES6220. Direct soldering of the exposed pad to the thermal land will provide an efficient thermal path. In multilayer board designs, thermal vias thermally connect the exposed pad to internal copper planes. Number of vias, spacing, via diameters and land pattern design depend on the application and the amount of heat to be removed from the package. A nine thermal via array, arranged in a 3 x 3 array and using a 1.2 mm pitch in the center of the thermal land is a requirement for MC100ES6220 applications on multi-layer boards. The recommended thermal land design comprises a 3 x 3 thermal via array as shown in Figure 6, providing an efficient heat removal path.



**Figure 6. Recommended thermal land pattern**

The via diameter is should be approx. 0.3 mm with 1 oz. copper via barrel plating. Solder wicking inside the via resulting in voids during the solder process must be avoided. If the copper plating does not plug the vias, stencil print solder paste onto the printed circuit pad. This will supply enough solder paste to fill those vias and not starve the solder joints. The attachment process for exposed pad package is equivalent to standard surface mount packages. Figure 7 shows a recommend solder mask opening with respect to the recommended 3 x 3 thermal via array. Because a large solder mask opening may result in a poor release, the opening should be subdivided as shown in Figure 7. For the nominal

package standoff 0.1 mm, a stencil thickness of 5 to 8 mils should be considered.

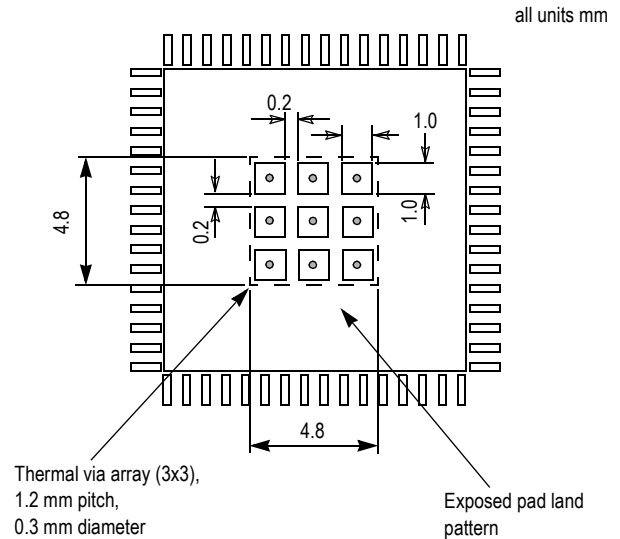

**Figure 7. Recommended Solder Mask Openings**

For thermal system analysis and junction temperature calculation the thermal resistance parameters of the package is provided:

**Table 8. Thermal Resistance<sup>(1)</sup>**

ConvectionL FPM	$R_{THJA}^{(2)}$ °C/W	$R_{THJA}^{(3)}$ °C/W	$R_{THJC}$ °C/W	$R_{THJB}^{(4)}$ °C/W
Natural	20	48	4 <sup>(5)</sup> 29 <sup>(6)</sup>	16
100	18	47		
200	17	46		
400	16	43		
800	15	41		

1. Applicable for a 3 x 3 thermal via array.
2. Junction to ambient, four conductor layer test board (2S2P), per JES51-7 and JESD 51-5.
3. Junction to ambient, single layer test board, per JESD51-3.
4. Junction to board, four conductor layer test board (2S2P) per JESD 51-8.
5. Junction to exposed pad.
6. Junction to top of package.

It is recommended that users employ thermal modeling analysis to assist in applying the general recommendations to their particular application. The exposed pad of the MC100ES6220 package does not have an electrical low impedance path to the substrate of the integrated circuit and its terminals. The thermal land should be connected to GND through connection of internal board layers.



# PACKAGE DIMENSIONS

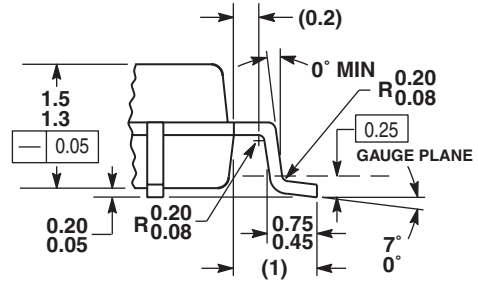
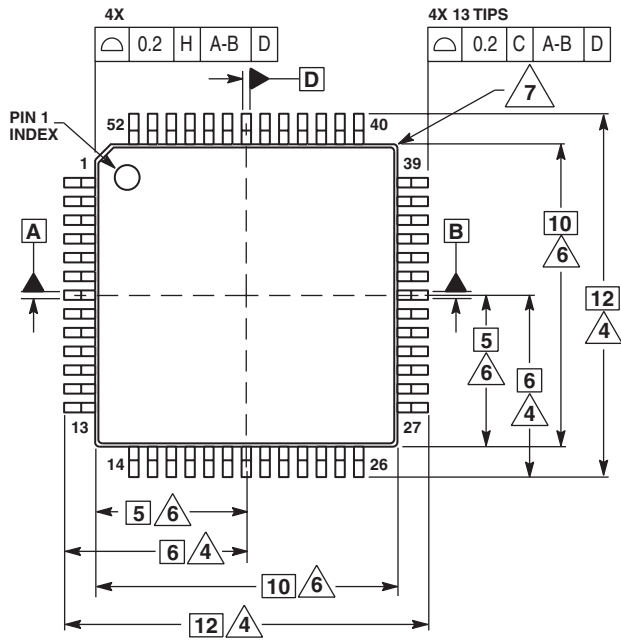

VIEW AA

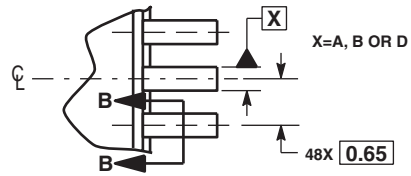

VIEW Y

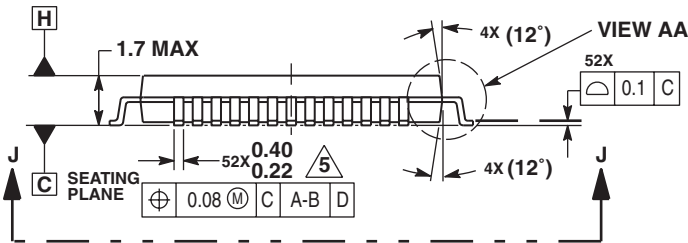

VIEW AA

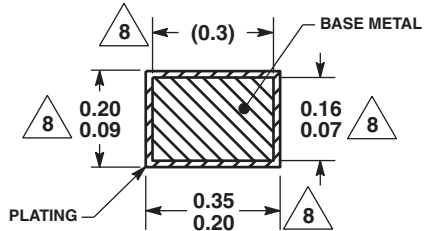

SECTION B-B

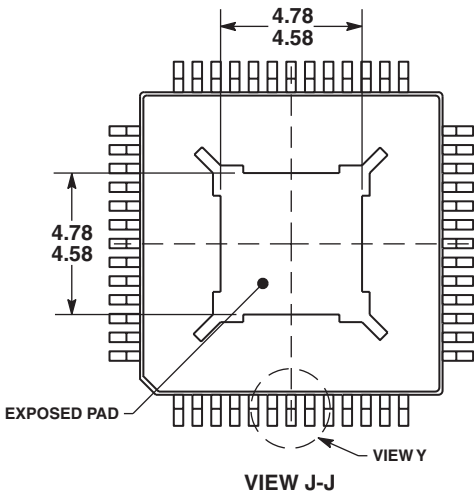

VIEW J-J

## NOTES:

1. DIMENSIONS ARE IN MILLIMETERS.
2. INTERPRET DIMENSIONS AND TOLERANCES PER ASME Y14.5M, 1994.
3. DATUMS A, B AND D TO BE DETERMINED AT DATUM PLANE H.
4. DIMENSION TO BE DETERMINED AT SEATING PLANE C.
5. THIS DIMENSION DOES NOT INCLUDE DAMBAR PROTRUSION. ALLOWABLE DAMBAR PROTRUSION SHALL NOT CAUSE THE LEAD WIDTH TO EXCEED 0.46 mm. DAMBAR CANNOT BE LOCATED ON THE LOWER RADIUS OR THE FOOT. MINIMUM SPACE BETWEEN PROTRUSION AND ADJACENT LEAD SHALL NOT BE LESS THAN 0.07 mm.
6. THIS DIMENSION DOES NOT INCLUDE MOLD PROTRUSION. ALLOWABLE PROTRUSION IS 0.25mm PER SIDE. THIS DIMENSION IS MAXIMUM PLSTIC BODY SIZE DIMENSION INCLUDING MOLD MISMATCH.
7. EXACT SHAPE OF EACH CORNER IS OPTIONAL.
8. THESE DIMENSIONS APPLY TO THE FLAT SECTION OF THE LEAD BETWEEN 0.10mm AND 0.25mm FROM THE LEAD TIP.

## CASE 1336A-01 ISSUE O 52-LEAD LQFP PACKAGE

---

# NOTES

# NOTES

---

# NOTES

## **How to Reach Us:**

### **Home Page:**

[www.freescale.com](http://www.freescale.com)

### **E-mail:**

[support@freescale.com](mailto:support@freescale.com)

### **USA/Europe or Locations Not Listed:**

Freescale Semiconductor  
Technical Information Center, CH370  
1300 N. Alma School Road  
Chandler, Arizona 85224  
+1-800-521-6274 or +1-480-768-2130  
[support@freescale.com](mailto:support@freescale.com)

### **Europe, Middle East, and Africa:**

Freescale Halbleiter Deutschland GmbH  
Technical Information Center  
Schatzbogen 7  
81829 Muenchen, Germany  
+44 1296 380 456 (English)  
+46 8 52200080 (English)  
+49 89 92103 559 (German)  
+33 1 69 35 48 48 (French)  
[support@freescale.com](mailto:support@freescale.com)

### **Japan:**

Freescale Semiconductor Japan Ltd.  
Headquarters  
ARCO Tower 15F  
1-8-1, Shimo-Meguro, Meguro-ku,  
Tokyo 153-0064  
Japan  
0120 191014 or +81 3 5437 9125  
[support.japan@freescale.com](mailto:support.japan@freescale.com)

### **Asia/Pacific:**

Freescale Semiconductor Hong Kong Ltd.  
Technical Information Center  
2 Dai King Street  
Tai Po Industrial Estate  
Tai Po, N.T., Hong Kong  
+800 2666 8080  
[support.asia@freescale.com](mailto:support.asia@freescale.com)

### **For Literature Requests Only:**

Freescale Semiconductor Literature Distribution Center  
P.O. Box 5405  
Denver, Colorado 80217  
1-800-441-2447 or 303-675-2140  
Fax: 303-675-2150  
[LDCForFreescaleSemiconductor@hibbertgroup.com](mailto:LDCForFreescaleSemiconductor@hibbertgroup.com)

Information in this document is provided solely to enable system and software implementers to use Freescale Semiconductor products. There are no express or implied copyright licenses granted hereunder to design or fabricate any integrated circuits or integrated circuits based on the information in this document.

Freescale Semiconductor reserves the right to make changes without further notice to any products herein. Freescale Semiconductor makes no warranty, representation or guarantee regarding the suitability of its products for any particular purpose, nor does Freescale Semiconductor assume any liability arising out of the application or use of any product or circuit, and specifically disclaims any and all liability, including without limitation consequential or incidental damages. "Typical" parameters that may be provided in Freescale Semiconductor data sheets and/or specifications can and do vary in different applications and actual performance may vary over time. All operating parameters, including "Typicals", must be validated for each customer application by customer's technical experts. Freescale Semiconductor does not convey any license under its patent rights nor the rights of others. Freescale Semiconductor products are not designed, intended, or authorized for use as components in systems intended for surgical implant into the body, or other applications intended to support or sustain life, or for any other application in which the failure of the Freescale Semiconductor product could create a situation where personal injury or death may occur. Should Buyer purchase or use Freescale Semiconductor products for any such unintended or unauthorized application, Buyer shall indemnify and hold Freescale Semiconductor and its officers, employees, subsidiaries, affiliates, and distributors harmless against all claims, costs, damages, and expenses, and reasonable attorney fees arising out of, directly or indirectly, any claim of personal injury or death associated with such unintended or unauthorized use, even if such claim alleges that Freescale Semiconductor was negligent regarding the design or manufacture of the part.

Freescale™ and the Freescale logo are trademarks of Freescale Semiconductor, Inc. All other product or service names are the property of their respective owners.

© Freescale Semiconductor, Inc. 2005. All rights reserved.