



Chipsmall Limited consists of a professional team with an average of over 10 year of expertise in the distribution of electronic components. Based in Hongkong, we have already established firm and mutual-benefit business relationships with customers from,Europe,America and south Asia,supplying obsolete and hard-to-find components to meet their specific needs.

With the principle of "Quality Parts,Customers Priority,Honest Operation,and Considerate Service",our business mainly focus on the distribution of electronic components. Line cards we deal with include Microchip,ALPS,ROHM,Xilinx,Pulse,ON,Everlight and Freescale. Main products comprise IC,Modules,Potentiometer,IC Socket,Relay,Connector.Our parts cover such applications as commercial,industrial, and automotives areas.

We are looking forward to setting up business relationship with you and hope to provide you with the best service and solution. Let us make a better world for our industry!



## Contact us

Tel: +86-755-8981 8866 Fax: +86-755-8427 6832

Email & Skype: info@chipsmall.com Web: www.chipsmall.com

Address: A1208, Overseas Decoration Building, #122 Zhenhua RD., Futian, Shenzhen, China



# MC10EP17, MC100EP17

## 3.3 V / 5 V ECL Quad Differential Driver/Receiver

### Description

The MC10/100EP17 is a 4-bit differential line receiver based on the EP17 device. The > 3.0 GHz maximum frequency provided by the high frequency outputs makes the device ideal for buffering of very high speed oscillators.

The  $V_{BB}$  pin, an internally generated voltage supply, is available to this device only. For single-ended input conditions, the unused differential input is connected to  $V_{BB}$  as a switching reference voltage.  $V_{BB}$  may also rebias AC coupled inputs. When used, decouple  $V_{BB}$  and  $V_{CC}$  via a 0.01  $\mu$ F capacitor and limit current sourcing or sinking to 0.5 mA. When not used,  $V_{BB}$  should be left open.

The design incorporates two stages of gain, internal to the device, making it an excellent choice for use in high bandwidth amplifier applications.

Inputs of unused gates can be left open and will not affect the operation of the rest of the device. All  $V_{CC}$  and  $V_{EE}$  pins must be externally connected to power supply to guarantee proper operation.

The 100 Series contains temperature compensation.

### Features

- 220 ps Typical Propagation Delay
- Maximum Frequency > 3.0 GHz Typical
- PECL Mode Operating Range:
  - ♦  $V_{CC} = 3.0$  V to 5.5 V with  $V_{EE} = 0$  V
- NECL Mode Operating Range:
  - ♦  $V_{CC} = 0$  V with  $V_{EE} = -3.0$  V to -5.5 V
- Open Input Default State
- Safety Clamp on Inputs
- Q Output Will Default LOW with Inputs Open or at  $V_{EE}$
- $V_{BB}$  Output
- These Devices are Pb-Free, Halogen Free and are RoHS Compliant



ON Semiconductor®

<http://onsemi.com>

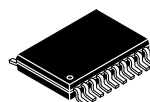

TSSOP-20  
DT SUFFIX  
CASE 948E

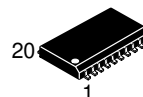

SOIC-20 WB  
DW SUFFIX  
CASE 751D-05



QFN-20  
MN SUFFIX  
CASE 485E-01

### MARKING DIAGRAMS\*

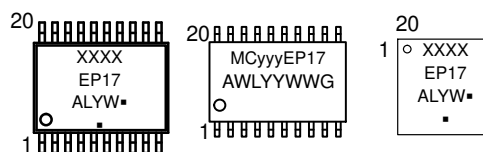

XXXX = MC10 or 100  
yyy = 10 or 100  
A = Assembly Location  
L, = Assembly Lot  
WL = Wafer Lot  
Y, YY = Year  
W, WW = Work Week  
G or ■ = Pb-Free Package

(Note: Microdot may be in either location)

\*For additional marking information, refer to Application Note [AND8002/D](#).

### ORDERING INFORMATION

See detailed ordering and shipping information on page 8 of this data sheet.

# MC10EP17, MC100EP17

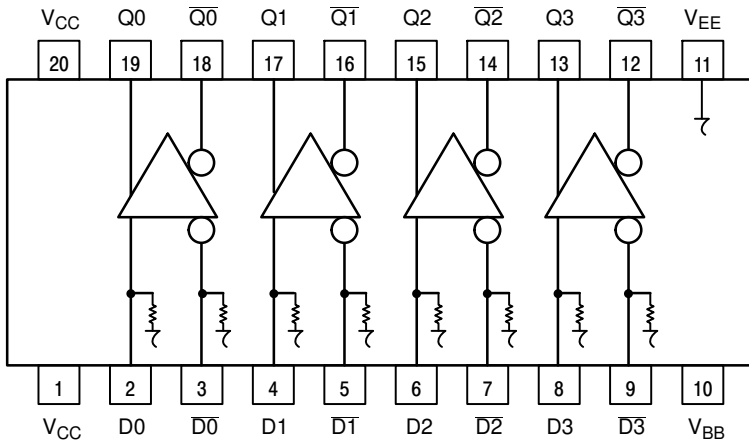
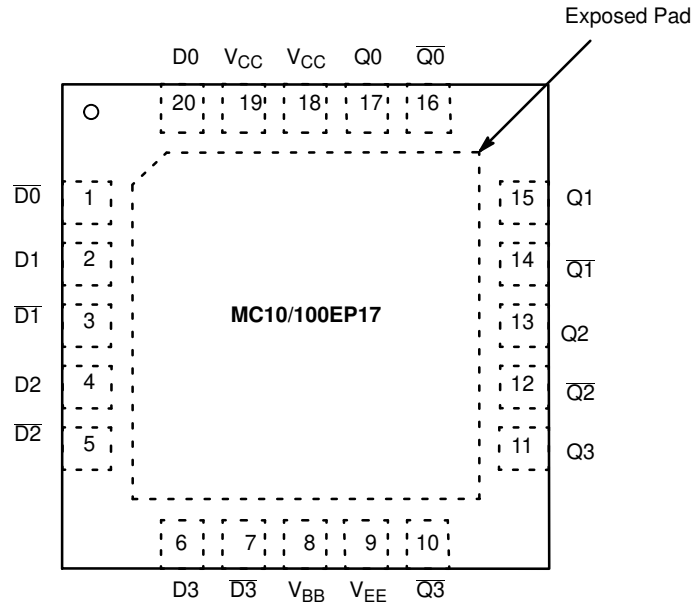

**Table 1. PIN DESCRIPTION**

PIN	FUNCTION
D[0:3]*, D[0:3]*	ECL Differential Data Inputs
Q[0:3], Q[0:3]	ECL Differential Data Outputs
V <sub>BB</sub>	Reference Voltage Output
V <sub>CC</sub>	Positive Supply
V <sub>EE</sub>	Negative Supply
EP	Exposed Pad

\* Pins will default LOW when left open.

**Figure 1. 20-Lead Pinout (Top View) and Logic Diagram**



NOTE: The Exposed Pad (EP) on package bottom must be attached to a heat-sinking conduit. The Exposed Pad may only be electrically connected to V<sub>EE</sub>.

**Figure 1. QFN-20 Pinout (Top View)**

**Table 2. ATTRIBUTES**

Characteristics	Value
Internal Input Pulldown Resistor	75 kΩ
Internal Input Pullup Resistor	N/A
ESD Protection Human Body Model Machine Model Charged Device Model	> 2 kV > 100 V > 2 kV
Moisture Sensitivity, Indefinite Time Out of Drypack (Note 1)	Pb-Free Pkg
SOIC-20 WB TSSOP-20 WB QFN-20	Level 3 Level 3 Level 1
Flammability Rating Oxygen Index: 28 to 34	UL 94 V-0 @ 0.125 in
Transistor Count	259 Devices
Meets or exceeds JEDEC Spec EIA/JESD78 IC Latchup Test	

1. For additional information, see Application Note [AND8003/D](#).



# MC10EP17, MC100EP17

**Table 3. MAXIMUM RATINGS**

Symbol	Parameter	Condition 1	Condition 2	Rating	Unit
V <sub>CC</sub>	PECL Mode Power Supply	V <sub>EE</sub> = 0 V		6	V
V <sub>EE</sub>	NECL Mode Power Supply	V <sub>CC</sub> = 0 V		-6	V
V <sub>I</sub>	PECL Mode Input Voltage NECL Mode Input Voltage	V <sub>EE</sub> = 0 V V <sub>CC</sub> = 0 V	V <sub>I</sub> ≤ V <sub>CC</sub> V <sub>I</sub> ≥ V <sub>EE</sub>	6 -6	V
I <sub>out</sub>	Output Current	Continuous Surge		50 100	mA
I <sub>BB</sub>	V <sub>BB</sub> Sink/Source			± 0.5	mA
T <sub>A</sub>	Operating Temperature Range			-40 to +85	°C
T <sub>stg</sub>	Storage Temperature Range			-65 to +150	°C
θ <sub>JA</sub>	Thermal Resistance (Junction-to-Ambient)	0 lfpm 500 lfpm	TSSOP-20 WB	140 100	°C/W
θ <sub>JC</sub>	Thermal Resistance (Junction-to-Case)	Standard Board	TSSOP-20 WB	23 to 41	°C/W
θ <sub>JA</sub>	Thermal Resistance (Junction-to-Ambient)	0 lfpm 500 lfpm	SOIC-20 WB	90 60	°C/W
θ <sub>JC</sub>	Thermal Resistance (Junction-to-Case)	Standard Board	SOIC-20 WB	30 to 35	°C/W
θ <sub>JA</sub>	Thermal Resistance (Junction-to-Ambient)	0 lfpm 500 lfpm	QFN-20	47 33	°C/W
θ <sub>JC</sub>	Thermal Resistance (Junction-to-Case)	Standard Board	QFN-20	18	°C/W
T <sub>sol</sub>	Wave Solder (Pb-Free)			265	°C

Stresses exceeding those listed in the Maximum Ratings table may damage the device. If any of these limits are exceeded, device functionality should not be assumed, damage may occur and reliability may be affected.

**Table 4. 10EP DC CHARACTERISTICS, PECL** (V<sub>CC</sub> = 3.3 V, V<sub>EE</sub> = 0 V (Note 1))

Symbol	Characteristic	-40°C			25°C			85°C			Unit
		Min	Typ	Max	Min	Typ	Max	Min	Typ	Max	
I <sub>EE</sub>	Power Supply Current	42	50	65	44	52	66	46	54	68	mA
V <sub>OH</sub>	Output HIGH Voltage (Note 2)	2165	2290	2415	2230	2355	2480	2290	2415	2540	mV
V <sub>OL</sub>	Output LOW Voltage (Note 2)	1365	1490	1615	1430	1555	1680	1490	1615	1740	mV
V <sub>IH</sub>	Input HIGH Voltage (Single-Ended)	2090		2415	2155		2480	2215		2540	mV
V <sub>IL</sub>	Input LOW Voltage (Single-Ended)	365		1690	1430		1755	1490		1815	mV
V <sub>BB</sub>	Output Voltage Reference	1790	1890	1990	1855	1955	2055	1915	2015	2115	mV
V <sub>IHCMR</sub>	Input HIGH Voltage Common Mode Range (Differential) (Note 3)	2.0		3.3	2.0		3.3	2.0		3.3	V
I <sub>IH</sub>	Input HIGH Current			150			150			150	μA
I <sub>IL</sub>	Input LOW Current	0.5			0.5			0.5			μA

NOTE: Device will meet the specifications after thermal equilibrium has been established when mounted in a test socket or printed circuit board with maintained transverse airflow greater than 500 lfpm. Electrical parameters are guaranteed only over the declared operating temperature range. Functional operation of the device exceeding these conditions is not implied. Device specification limit values are applied individually under normal operating conditions and not valid simultaneously.

1. Input and output parameters vary 1:1 with V<sub>CC</sub>. V<sub>EE</sub> can vary +0.3 V to -2.2 V.
2. All loading with 50 Ω to V<sub>CC</sub> - 2.0 V.
3. V<sub>IHCMR</sub> min varies 1:1 with V<sub>EE</sub>. V<sub>IHCMR</sub> max varies 1:1 with V<sub>CC</sub>. The V<sub>IHCMR</sub> range is referenced to the most positive side of the differential input signal.

# MC10EP17, MC100EP17

**Table 5. 10EP DC CHARACTERISTICS, PECL** ( $V_{CC} = 5.0\text{ V}$ ,  $V_{EE} = 0\text{ V}$  (Note 1))

Symbol	Characteristic	-40°C			25°C			85°C			Unit
		Min	Typ	Max	Min	Typ	Max	Min	Typ	Max	
$I_{EE}$	Power Supply Current	42	50	65	44	52	66	46	54	68	mA
$V_{OH}$	Output HIGH Voltage (Note 2)	3865	3990	4115	3930	4055	4180	3990	4115	4240	mV
$V_{OL}$	Output LOW Voltage (Note 2)	3065	3190	3315	3130	3255	3380	3190	3315	3440	mV
$V_{IH}$	Input HIGH Voltage (Single-Ended)	3790		4115	3855		4180	3915		4240	mV
$V_{IL}$	Input LOW Voltage (Single-Ended)	3065		3390	3130		3455	3190		3515	mV
$V_{BB}$	Output Voltage Reference	3490	3590	3690	3555	3655	3755	3615	3715	3815	mV
$V_{IHCMR}$	Input HIGH Voltage Common Mode Range (Differential) (Note 3)	2.0		5.0	2.0		5.0	2.0		5.0	V
$I_{IH}$	Input HIGH Current			150			150			150	$\mu\text{A}$
$I_{IL}$	Input LOW Current	0.5			0.5			0.5			$\mu\text{A}$

NOTE: Device will meet the specifications after thermal equilibrium has been established when mounted in a test socket or printed circuit board with maintained transverse airflow greater than 500 lpm. Electrical parameters are guaranteed only over the declared operating temperature range. Functional operation of the device exceeding these conditions is not implied. Device specification limit values are applied individually under normal operating conditions and not valid simultaneously.

1. Input and output parameters vary 1:1 with  $V_{CC}$ .  $V_{EE}$  can vary +2.0 V to -0.5 V.
2. All loading with  $50\ \Omega$  to  $V_{CC} - 2.0\text{ V}$ .
3.  $V_{IHCMR}$  min varies 1:1 with  $V_{EE}$ ,  $V_{IHCMR}$  max varies 1:1 with  $V_{CC}$ . The  $V_{IHCMR}$  range is referenced to the most positive side of the differential input signal.

**Table 6. 10EP DC CHARACTERISTICS, NECL** ( $V_{CC} = 0\text{ V}$ ;  $V_{EE} = -5.5\text{ V}$  to  $-3.0\text{ V}$  (Note 1))

Symbol	Characteristic	-40°C			25°C			85°C			Unit
		Min	Typ	Max	Min	Typ	Max	Min	Typ	Max	
$I_{EE}$	Power Supply Current	42	50	65	44	52	66	46	54	68	mA
$V_{OH}$	Output HIGH Voltage (Note 2)	-1135	-1010	-885	-1070	-945	-820	-1010	-885	-760	mV
$V_{OL}$	Output LOW Voltage (Note 2)	-1935	-1810	-1685	-1870	-1745	-1620	-1810	-1685	-1560	mV
$V_{IH}$	Input HIGH Voltage (Single-Ended)	-1210		-885	-1145		-820	-1085		-760	mV
$V_{IL}$	Input LOW Voltage (Single-Ended)	-1935		-1610	-1870		-1545	-1810		-1485	mV
$V_{BB}$	Output Voltage Reference	-1510	-1410	-1310	-1445	-1345	-1245	-1385	-1285	-1185	mV
$V_{IHCMR}$	Input HIGH Voltage Common Mode Range (Differential) (Note 3)	$V_{EE} + 2.0$		0.0	$V_{EE} + 2.0$		0.0	$V_{EE} + 2.0$		0.0	V
$I_{IH}$	Input HIGH Current			150			150			150	$\mu\text{A}$
$I_{IL}$	Input LOW Current	0.5			0.5			0.5			$\mu\text{A}$

NOTE: Device will meet the specifications after thermal equilibrium has been established when mounted in a test socket or printed circuit board with maintained transverse airflow greater than 500 lpm. Electrical parameters are guaranteed only over the declared operating temperature range. Functional operation of the device exceeding these conditions is not implied. Device specification limit values are applied individually under normal operating conditions and not valid simultaneously.

1. Input and output parameters vary 1:1 with  $V_{CC}$ .
2. All loading with  $50\ \Omega$  to  $V_{CC} - 2.0\text{ V}$ .
3.  $V_{IHCMR}$  min varies 1:1 with  $V_{EE}$ ,  $V_{IHCMR}$  max varies 1:1 with  $V_{CC}$ . The  $V_{IHCMR}$  range is referenced to the most positive side of the differential input signal.

# MC10EP17, MC100EP17

**Table 7. 100EP DC CHARACTERISTICS, PECL** ( $V_{CC} = 3.3\text{ V}$ ,  $V_{EE} = 0\text{ V}$  (Note 1))

Symbol	Characteristic	-40°C			25°C			85°C			Unit
		Min	Typ	Max	Min	Typ	Max	Min	Typ	Max	
$I_{EE}$	Power Supply Current	47	55	63	50	58	66	54	62	70	mA
$V_{OH}$	Output HIGH Voltage (Note 2)	2155	2280	2405	2155	2280	2405	2155	2280	2405	mV
$V_{OL}$	Output LOW Voltage (Note 2)	1355	1480	1605	1355	1480	1605	1355	1480	1605	mV
$V_{IH}$	Input HIGH Voltage (Single-Ended)	2075		2420	2075		2420	2075		2420	mV
$V_{IL}$	Input LOW Voltage (Single-Ended)	1355		1675	1355		1675	1355		1675	mV
$V_{BB}$	Output Voltage Reference	1775	1875	1975	1775	1875	1975	1775	1875	1975	mV
$V_{IHCMR}$	Input HIGH Voltage Common Mode Range (Differential) (Note 3)	2.0		3.3	2.0		3.3	2.0		3.3	V
$I_{IH}$	Input HIGH Current			150			150			150	μA
$I_{IL}$	Input LOW Current	0.5			0.5			0.5			μA

NOTE: Device will meet the specifications after thermal equilibrium has been established when mounted in a test socket or printed circuit board with maintained transverse airflow greater than 500 lpm. Electrical parameters are guaranteed only over the declared operating temperature range. Functional operation of the device exceeding these conditions is not implied. Device specification limit values are applied individually under normal operating conditions and not valid simultaneously.

1. Input and output parameters vary 1:1 with  $V_{CC}$ .  $V_{EE}$  can vary +0.3 V to -2.2 V.
2. All loading with 50 Ω to  $V_{CC} - 2.0\text{ V}$ .
3.  $V_{IHCMR}$  min varies 1:1 with  $V_{EE}$ ,  $V_{IHCMR}$  max varies 1:1 with  $V_{CC}$ . The  $V_{IHCMR}$  range is referenced to the most positive side of the differential input signal.

**Table 8. 100EP DC CHARACTERISTICS, PECL** ( $V_{CC} = 5.0\text{ V}$ ,  $V_{EE} = 0\text{ V}$  (Note 1))

Symbol	Characteristic	-40°C			25°C			85°C			Unit
		Min	Typ	Max	Min	Typ	Max	Min	Typ	Max	
$I_{EE}$	Power Supply Current	47	55	63	50	58	66	54	62	70	mA
$V_{OH}$	Output HIGH Voltage (Note 2)	3855	3980	4105	3855	3980	4105	3855	3980	4105	mV
$V_{OL}$	Output LOW Voltage (Note 2)	3055	3180	3305	3055	3180	3305	3055	3180	3305	mV
$V_{IH}$	Input HIGH Voltage (Single-Ended)	3775		4120	3775		4120	3775		4120	mV
$V_{IL}$	Input LOW Voltage (Single-Ended)	3055		3375	3055		3375	3055		3375	mV
$V_{BB}$	Output Voltage Reference	3475	3575	3675	3475	3575	3675	3475	3575	3675	mV
$V_{IHCMR}$	Input HIGH Voltage Common Mode Range (Differential) (Note 3)	2.0		5.0	2.0		5.0	2.0		5.0	V
$I_{IH}$	Input HIGH Current			150			150			150	μA
$I_{IL}$	Input LOW Current	0.5			0.5			0.5			μA

NOTE: Device will meet the specifications after thermal equilibrium has been established when mounted in a test socket or printed circuit board with maintained transverse airflow greater than 500 lpm. Electrical parameters are guaranteed only over the declared operating temperature range. Functional operation of the device exceeding these conditions is not implied. Device specification limit values are applied individually under normal operating conditions and not valid simultaneously.

1. Input and output parameters vary 1:1 with  $V_{CC}$ .  $V_{EE}$  can vary +2.0 V to -0.5 V.
2. All loading with 50 Ω to  $V_{CC} - 2.0\text{ V}$ .
3.  $V_{IHCMR}$  min varies 1:1 with  $V_{EE}$ ,  $V_{IHCMR}$  max varies 1:1 with  $V_{CC}$ . The  $V_{IHCMR}$  range is referenced to the most positive side of the differential input signal.

# MC10EP17, MC100EP17

**Table 9. 100EP DC CHARACTERISTICS, NECL** ( $V_{CC} = 0\text{ V}$ ;  $V_{EE} = -5.5\text{ V to }-3.0\text{ V}$  (Note 1))

Symbol	Characteristic	-40°C			25°C			85°C			Unit
		Min	Typ	Max	Min	Typ	Max	Min	Typ	Max	
$I_{EE}$	Power Supply Current	47	55	63	50	58	66	54	62	70	mA
$V_{OH}$	Output HIGH Voltage (Note 2)	-1145	-1020	-895	-1145	-1020	-895	-1145	-1020	-895	mV
$V_{OL}$	Output LOW Voltage (Note 2)	-1945	-1820	-1695	-1945	-1820	-1695	-1945	-1820	-1695	mV
$V_{IH}$	Input HIGH Voltage (Single-Ended)	-1225		-880	-1225		-880	-1225		-880	mV
$V_{IL}$	Input LOW Voltage (Single-Ended)	-1945		-1625	-1945		-1625	-1945		-1625	mV
$V_{BB}$	Output Voltage Reference	-1525	-1425	-1325	-1525	-1425	-1325	-1525	-1425	-1325	mV
$V_{IHCMR}$	Input HIGH Voltage Common Mode Range (Differential) (Note 3)	$V_{EE} + 2.0$		0.0	$V_{EE} + 2.0$		0.0	$V_{EE} + 2.0$		0.0	V
$I_{IH}$	Input HIGH Current			150			150			150	$\mu\text{A}$
$I_{IL}$	Input LOW Current	0.5			0.5			0.5			$\mu\text{A}$

NOTE: Device will meet the specifications after thermal equilibrium has been established when mounted in a test socket or printed circuit board with maintained transverse airflow greater than 500 lfm. Electrical parameters are guaranteed only over the declared operating temperature range. Functional operation of the device exceeding these conditions is not implied. Device specification limit values are applied individually under normal operating conditions and not valid simultaneously.

1. Input and output parameters vary 1:1 with  $V_{CC}$ .
2. All loading with  $50\ \Omega$  to  $V_{CC} - 2.0\text{ V}$ .
3.  $V_{IHCMR}$  min varies 1:1 with  $V_{EE}$ ,  $V_{IHCMR}$  max varies 1:1 with  $V_{CC}$ . The  $V_{IHCMR}$  range is referenced to the most positive side of the differential input signal.

**Table 10. AC CHARACTERISTICS** ( $V_{CC} = 0\text{ V}$ ;  $V_{EE} = -3.0\text{ V to }-5.5\text{ V}$  or  $V_{CC} = 3.0\text{ V to }5.5\text{ V}$ ;  $V_{EE} = 0\text{ V}$  (Note 1))

Symbol	Characteristic	-40°C			25°C			85°C			Unit
		Min	Typ	Max	Min	Typ	Max	Min	Typ	Max	
$f_{max}$	Maximum Frequency (Figure 2)		> 3			> 3			> 3		GHz
$t_{PLH}$ , $t_{PHL}$	Propagation Delay to Output Differential 10 Series 100 Series	125 150	200 220	275 300	150 180	220 250	300 320	200 200	260 290	350 360	ps
$t_{JITTER}$	CLOCK Random Jitter (RMS) @ $\leq 1.0\text{ GHz}$ @ $\leq 1.5\text{ GHz}$ @ $\leq 2.0\text{ GHz}$ @ $\leq 2.5\text{ GHz}$ @ $\leq 3.0\text{ GHz}$		0.132 0.143 0.148 0.129 0.129	0.2 0.3 0.3 0.3 0.3		0.147 0.159 0.146 0.131 0.142	0.2 0.3 0.3 0.3 0.3		0.154 0.156 0.169 0.147 0.168	0.3 0.3 0.3 0.3 0.3	ps
$V_{PP}$	Input Voltage Swing (Differential Configuration)	150	800	1200	150	800	1200	150	800	1200	mV
$t_r$ $t_f$	Output Rise/Fall Times Q, (20% – 80%)	100	160	220	100	170	230	120	190	250	ps

NOTE: Device will meet the specifications after thermal equilibrium has been established when mounted in a test socket or printed circuit board with maintained transverse airflow greater than 500 lfm. Electrical parameters are guaranteed only over the declared operating temperature range. Functional operation of the device exceeding these conditions is not implied. Device specification limit values are applied individually under normal operating conditions and not valid simultaneously.

1. Measured using a 750 mV source, 50% duty cycle clock source. All loading with  $50\ \Omega$  to  $V_{CC} - 2.0\text{ V}$ .

# MC10EP17, MC100EP17

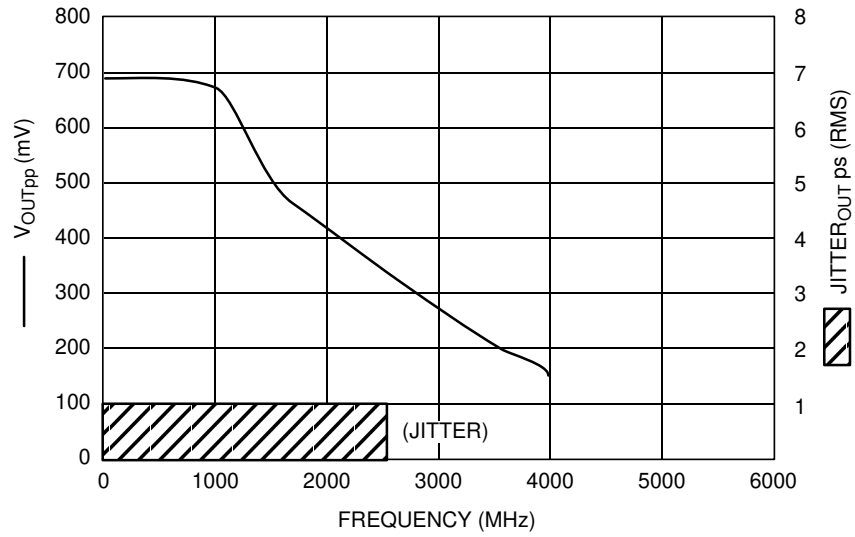

Figure 2.  $F_{max}$ /Jitter

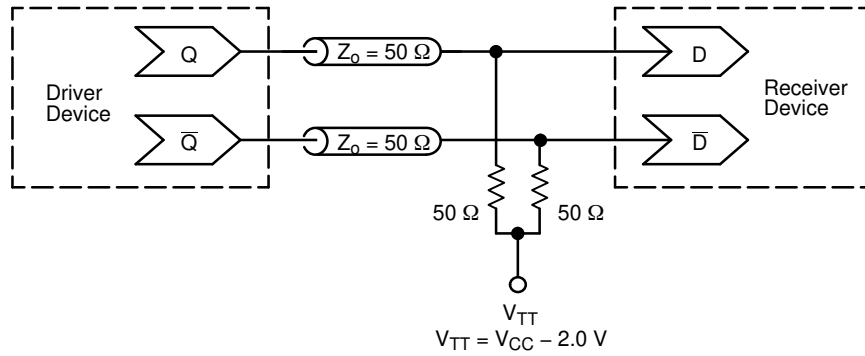

Figure 3. Typical Termination for Output Driver and Device Evaluation  
(See Application Note [AND8020/D](#) – Termination of ECL Logic Devices.)



## MC10EP17, MC100EP17

### ORDERING INFORMATION

Device	Package	Shipping†
MC10EP17DTG	TSSOP–20 WB (Pb-Free)	75 Units / Rail
MC10EP17DTR2G	TSSOP–20 WB (Pb-Free)	2500 / Tape & Reel
MC10EP17DWG	SOIC–20 WB (Pb-Free)	38 Units / Rail
MC10EP17DWR2G	SOIC–20 WB (Pb-Free)	1000 / Tape & Reel
MC10EP17MNG	QFN–20 (Pb-Free)	92 Units / Rail
MC10EP17MNTXG	QFN–20 (Pb-Free)	3000 / Tape & Reel
MC100EP17DTG	TSSOP–20 WB (Pb-Free)	75 Units / Rail
MC100EP17DTR2G	TSSOP–20 WB (Pb-Free)	2500 / Tape & Reel
MC100EP17DWG	SOIC–20 WB (Pb-Free)	38 Units / Rail
MC100EP17DWR2G	SOIC–20 WB (Pb-Free)	1000 / Tape & Reel
MC100EP17MNG	QFN–20 (Pb-Free)	92 Units / Rail
MC100EP17MNTXG	QFN–20 (Pb-Free)	3000 / Tape & Reel

†For information on tape and reel specifications, including part orientation and tape sizes, please refer to our Tape and Reel Packaging Specifications Brochure, [BRD8011/D](#).

#### Resource Reference of Application Notes

- AN1405/D** – ECL Clock Distribution Techniques
- AN1406/D** – Designing with PECL (ECL at +5.0 V)
- AN1503/D** – ECLinPS™ I/O SPICE Modeling Kit
- AN1504/D** – Metastability and the ECLinPS Family
- AN1568/D** – Interfacing Between LVDS and ECL
- AN1672/D** – The ECL Translator Guide
- AND8001/D** – Odd Number Counters Design
- AND8002/D** – Marking and Date Codes
- AND8020/D** – Termination of ECL Logic Devices
- AND8066/D** – Interfacing with ECLinPS
- AND8090/D** – AC Characteristics of ECL Devices

# MC10EP17, MC100EP17

## PACKAGE DIMENSIONS

TSSOP-20 WB  
CASE 948E  
ISSUE D

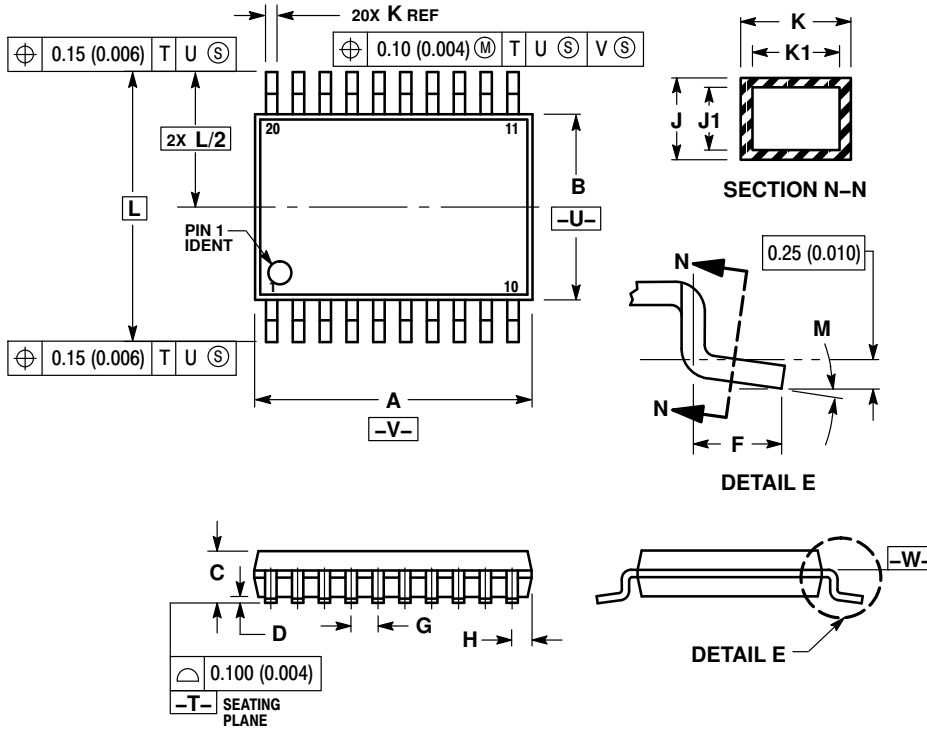

**NOTES:**

1. DIMENSIONING AND TOLERANCING PER ANSI Y14.5M, 1982.
2. CONTROLLING DIMENSION: MILLIMETER.
3. DIMENSION A DOES NOT INCLUDE MOLD FLASH, PROTRUSIONS OR GATE BURRS. MOLD FLASH OR GATE BURRS SHALL NOT EXCEED 0.15 (0.006) PER SIDE.
4. DIMENSION B DOES NOT INCLUDE INTERLEAD FLASH OR PROTRUSION. INTERLEAD FLASH OR PROTRUSION SHALL NOT EXCEED 0.25 (0.010) PER SIDE.
5. DIMENSION K DOES NOT INCLUDE DAMBAR PROTRUSION. ALLOWABLE DAMBAR PROTRUSION SHALL BE 0.08 (0.003) TOTAL IN EXCESS OF THE K DIMENSION AT MAXIMUM MATERIAL CONDITION.
6. TERMINAL NUMBERS ARE SHOWN FOR REFERENCE ONLY.
7. DIMENSION A AND B ARE TO BE DETERMINED AT DATUM PLANE -W-.

DIM	MILLIMETERS		INCHES	
	MIN	MAX	MIN	MAX
A	6.40	6.60	0.252	0.260
B	4.30	4.50	0.169	0.177
C	---	1.20	---	0.047
D	0.05	0.15	0.002	0.006
F	0.50	0.75	0.020	0.030
G	0.65 BSC		0.026 BSC	
H	0.27	0.37	0.011	0.015
J	0.09	0.20	0.004	0.008
J1	0.09	0.16	0.004	0.006
K	0.19	0.30	0.007	0.012
K1	0.19	0.25	0.007	0.010
L	6.40 BSC		0.252 BSC	
M	0°	8°	0°	8°

### SOLDERING FOOTPRINT

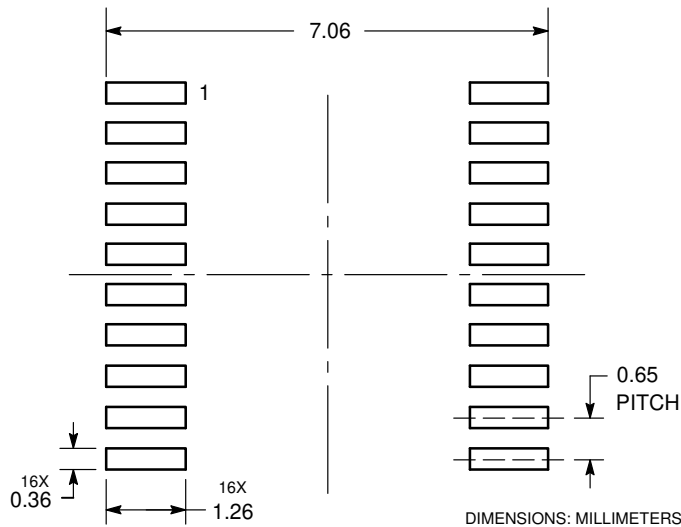

# MC10EP17, MC100EP17

## PACKAGE DIMENSIONS

SOIC-20 WB  
CASE 751D-05  
ISSUE H

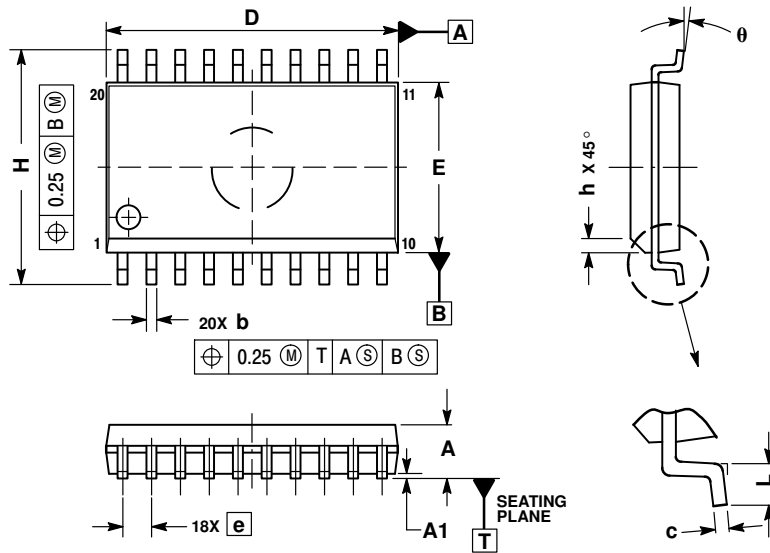

- NOTES:
1. DIMENSIONS ARE IN MILLIMETERS.
  2. INTERPRET DIMENSIONS AND TOLERANCES PER ASME Y14.5M, 1994.
  3. DIMENSIONS D AND E DO NOT INCLUDE MOLD PROTRUSION.
  4. MAXIMUM MOLD PROTRUSION 0.15 PER SIDE.
  5. DIMENSION B DOES NOT INCLUDE DAMBAR PROTRUSION. ALLOWABLE PROTRUSION SHALL BE 0.13 TOTAL IN EXCESS OF B DIMENSION AT MAXIMUM MATERIAL CONDITION.

MILLIMETERS		
DIM	MIN	MAX
A	2.35	2.65
A1	0.10	0.25
b	0.35	0.49
c	0.23	0.32
D	12.65	12.95
E	7.40	7.60
e	1.27 BSC	
H	10.05	10.55
h	0.25	0.75
L	0.50	0.90
θ	0°	7°

### RECOMMENDED SOLDERING FOOTPRINT\*

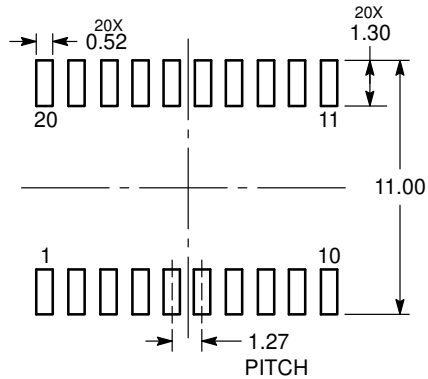

DIMENSIONS: MILLIMETERS

\*For additional information on our Pb-Free strategy and soldering details, please download the ON Semiconductor Soldering and Mounting Techniques Reference Manual, [SOLDERRM/D](#).

# MC10EP17, MC100EP17

## PACKAGE DIMENSIONS

QFN20, 4x4, 0.5P  
CASE 485E-01  
ISSUE B

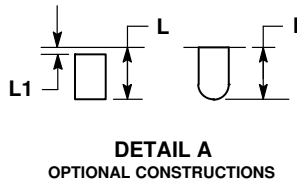
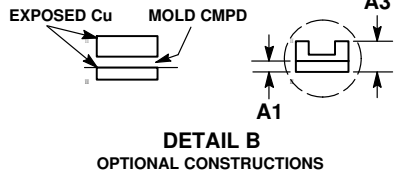
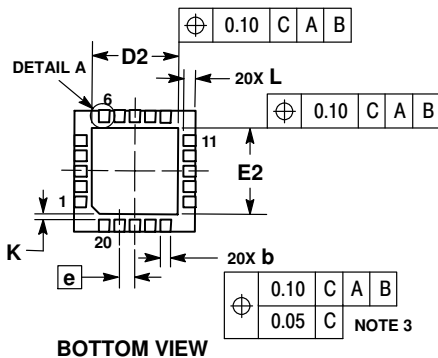
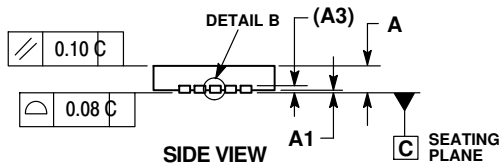
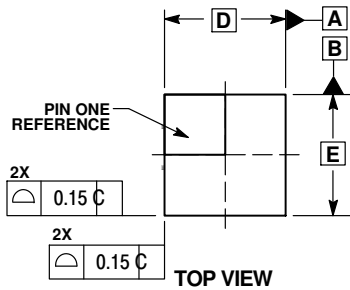

**NOTES:**

1. DIMENSIONING AND TOLERANCING PER ASME Y14.5M, 1994.
2. CONTROLLING DIMENSION: MILLIMETERS.
3. DIMENSION b APPLIES TO PLATED TERMINAL AND IS MEASURED BETWEEN 0.15 AND 0.30 MM FROM THE TERMINAL TIP.
4. COPLANARITY APPLIES TO THE EXPOSED PAD AS WELL AS THE TERMINALS.

DIM	MILLIMETERS	
	MIN	MAX
A	0.80	1.00
A1	---	0.05
A3	0.20	REF
b	0.20	0.30
D	4.00	BSC
D2	2.60	2.90
E	4.00	BSC
E2	2.60	2.90
e	0.50	BSC
K	0.20	REF
L	0.35	0.45
L1	0.00	0.15

**SOLDERING FOOTPRINT\***

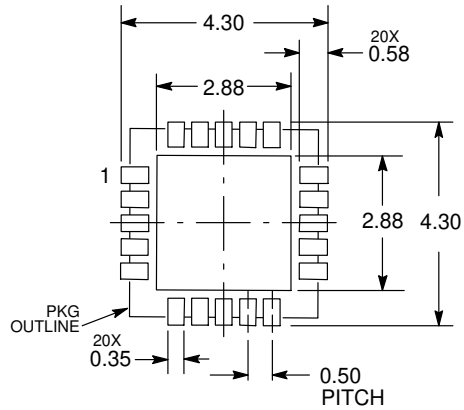

DIMENSIONS: MILLIMETERS

\*For additional information on our Pb-Free strategy and soldering details, please download the ON Semiconductor Soldering and Mounting Techniques Reference Manual, [SOLDERRM/D](#).

ECLinPS is a registered trademark of Semiconductor Components Industries, LLC (SCILLC) or its subsidiaries in the United States and/or other countries.

ON Semiconductor and are trademarks of Semiconductor Components Industries, LLC dba ON Semiconductor or its subsidiaries in the United States and/or other countries. ON Semiconductor owns the rights to a number of patents, trademarks, copyrights, trade secrets, and other intellectual property. A listing of ON Semiconductor's product/patent coverage may be accessed at [www.onsemi.com/site/pdf/Patent-Marking.pdf](http://www.onsemi.com/site/pdf/Patent-Marking.pdf). ON Semiconductor reserves the right to make changes without further notice to any products herein. ON Semiconductor makes no warranty, representation or guarantee regarding the suitability of its products for any particular purpose, nor does ON Semiconductor assume any liability arising out of the application or use of any product or circuit, and specifically disclaims any and all liability, including without limitation special, consequential or incidental damages. Buyer is responsible for its products and applications using ON Semiconductor products, including compliance with all laws, regulations and safety requirements or standards, regardless of any support or applications information provided by ON Semiconductor. "Typical" parameters which may be provided in ON Semiconductor data sheets and/or specifications can and do vary in different applications and actual performance may vary over time. All operating parameters, including "Typicals" must be validated for each customer application by customer's technical experts. ON Semiconductor does not convey any license under its patent rights nor the rights of others. ON Semiconductor products are not designed, intended, or authorized for use as a critical component in life support systems or any FDA Class 3 medical devices or medical devices with a same or similar classification in a foreign jurisdiction or any devices intended for implantation in the human body. Should Buyer purchase or use ON Semiconductor products for any such unintended or unauthorized application, Buyer shall indemnify and hold ON Semiconductor and its officers, employees, subsidiaries, affiliates, and distributors harmless against all claims, costs, damages, and expenses, and reasonable attorney fees arising out of, directly or indirectly, any claim of personal injury or death associated with such unintended or unauthorized use, even if such claim alleges that ON Semiconductor was negligent regarding the design or manufacture of the part. ON Semiconductor is an Equal Opportunity/Affirmative Action Employer. This literature is subject to all applicable copyright laws and is not for resale in any manner.

**PUBLICATION ORDERING INFORMATION**

**LITERATURE FULFILLMENT:**  
Literature Distribution Center for ON Semiconductor  
19521 E. 32nd Pkwy, Aurora, Colorado 80011 USA  
**Phone:** 303-675-2175 or 800-344-3860 Toll Free USA/Canada  
**Fax:** 303-675-2176 or 800-344-3867 Toll Free USA/Canada  
**Email:** [orderlit@onsemi.com](mailto:orderlit@onsemi.com)

**N. American Technical Support:** 800-282-9855 Toll Free  
USA/Canada  
**Europe, Middle East and Africa Technical Support:**  
Phone: 421 33 790 2910  
**Japan Customer Focus Center**  
Phone: 81-3-5817-1050

**ON Semiconductor Website:** [www.onsemi.com](http://www.onsemi.com)  
**Order Literature:** <http://www.onsemi.com/orderlit>  
For additional information, please contact your local Sales Representative