



Chipsmall Limited consists of a professional team with an average of over 10 year of expertise in the distribution of electronic components. Based in Hongkong, we have already established firm and mutual-benefit business relationships with customers from,Europe,America and south Asia,supplying obsolete and hard-to-find components to meet their specific needs.

With the principle of “Quality Parts,Customers Priority,Honest Operation,and Considerate Service”,our business mainly focus on the distribution of electronic components. Line cards we deal with include Microchip,ALPS,ROHM,Xilinx,Pulse,ON,Everlight and Freescale. Main products comprise IC,Modules,Potentiometer,IC Socket,Relay,Connector.Our parts cover such applications as commercial,industrial, and automotives areas.

We are looking forward to setting up business relationship with you and hope to provide you with the best service and solution. Let us make a better world for our industry!



## Contact us

Tel: +86-755-8981 8866 Fax: +86-755-8427 6832

Email & Skype: info@chipsmall.com Web: www.chipsmall.com

Address: A1208, Overseas Decoration Building, #122 Zhenhua RD., Futian, Shenzhen, China



# MC10H352

## Quad CMOS to PECL\* Translator

### Description

The MC10H352 is a quad translator for interfacing data between a CMOS logic section and the PECL section of digital systems when only a +5.0 Vdc power supply is available. The MC10H352 has CMOS compatible inputs and PECL complementary open-emitter outputs that allow use as an inverting/non-inverting translator or as a differential line driver. When the common strobe input is at a low logic level, it forces all true outputs to the PECL low logic state ( $\approx +3.2$  V) and all inverting outputs to the PECL high logic state ( $\approx +4.1$  V).

The MC10H352 can also be used with the MC10H350 to transmit and receive CMOS information differentially via balanced twisted pair lines.

### Features

- Single +5.0 V Power Supply
- All  $V_{CC}$  Pins Isolated On Chip
- Differentially Drive Balanced Lines
- $t_{pd} = 1.3$  nsec Typical
- Pb-Free Packages are Available\*



ON Semiconductor®

<http://onsemi.com>

### MARKING DIAGRAMS\*

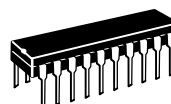

PDIP-20  
P SUFFIX  
CASE 738

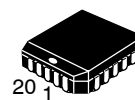
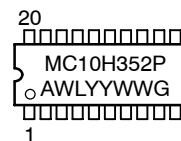

PLLCC-20  
FN SUFFIX  
CASE 775

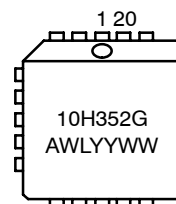

A = Assembly Location  
WL = Wafer Lot  
YY = Year  
WW = Work Week  
G = Pb-Free Package

\*For additional marking information, refer to Application Note AND8002/D.

### ORDERING INFORMATION

See detailed ordering and shipping information in the package dimensions section on page 4 of this data sheet.

\*For additional information on our Pb-Free strategy and soldering details, please download the ON Semiconductor Soldering and Mounting Techniques Reference Manual, SOLDERRM/D.

# MC10H352

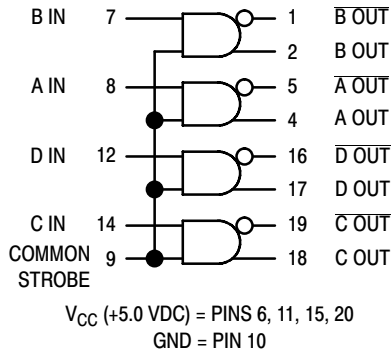

**Figure 1. Logic Diagram**

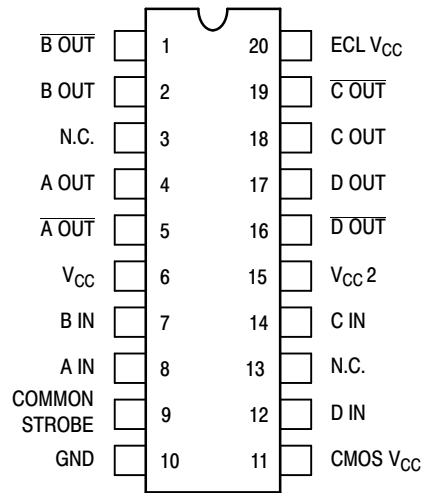

Pin assignment is for Dual-in-Line Package.  
 For PLCC pin assignment, see the Pin Conversion Tables on page 18  
 of the ON Semiconductor MECL Data Book (DL122/D).

**Figure 2. Pin Assignment**

**Table 1. MAXIMUM RATINGS**

Symbol	Characteristic	Rating	Unit
$V_{CC}$	Power Supply	0 to +7.0	Vdc
$V_I$	Input Voltage ( $V_{CC} = 5.0$ V)	0 to $V_{CC}$	Vdc
$I_{out}$	Output Current Continuous Surge	50 100	mA
$T_A$	Operating Temperature Range	0 to +75	°C
$T_{stg}$	Storage Temperature Range Plastic Ceramic	-55 to +150 -55 to +165	°C

Maximum ratings are those values beyond which device damage can occur. Maximum ratings applied to the device are individual stress limit values (not normal operating conditions) and are not valid simultaneously. If these limits are exceeded, device functional operation is not implied, damage may occur and reliability may be affected.

# MC10H352

**Table 2. ELECTRICAL CHARACTERISTICS** ( $V_{CC} = V_{CC1} = V_{CC2} = 5.0 \text{ V} \pm 5.0\%$ ) (Note 1)

Symbol	Characteristic	0°		25°		75°		Unit
		Min	Max	Min	Max	Min	Max	
ECL	Power Supply Current		50		45		50	mA
TTL			20		15		20	mA
$I_R$	Reverse Current Pins 7, 8, 12, 14 Pin 9		25		20		25	$\mu\text{A}$
			100		80		100	
$I_F$	Forward Current Pins 7, 8, 12, 14 Pin 9		-0.8		-0.6		-0.8	mA
			-3.2		-2.4		-3.2	
$V_{(BR)in}$	Input Voltage Breakdown	5.5		5.5		5.5		Vdc
$V_I$	Input Clamp Voltage ( $I_{in} = -18 \text{ mA}$ )		-1.5		-1.5		-1.5	Vdc
$V_{OH}$	High Output Voltage (Note 2)	3.98	4.16	4.02	4.19	4.08	4.27	Vdc
$V_{OL}$	Low Output Voltage (Note 2)	3.05	3.37	3.05	3.37	3.05	3.37	Vdc
$V_{IH}$	High Input Voltage	3.15		3.15		3.15		Vdc
$V_{IL}$	Low Input Voltage		1.5		1.5		1.5	Vdc

\*Positive Emitter Coupled Logic

- Each MECL 10H™ series circuit has been designed to meet the dc specifications shown in the test table, after thermal equilibrium has been established. The circuit is in a test socket or mounted on a printed circuit board and transverse air flow greater than 500 lfpm is maintained. Outputs are terminated through a 50  $\Omega$  resistor to  $V_{CC} - 2.0 \text{ Vdc}$ .
- With  $V_{CC}$  at 5.0 V.  $V_{OH}/V_{OL}$  change 1:1 with  $V_{CC}$ .

**Table 3. AC PARAMETERS**

Symbol	Characteristic	0°		25°		75°		Unit
		Min	Max	Min	Max	Min	Max	
$t_{pd}$	Propagation Delay (Note 3)	0.4	1.9	0.4	2.0	0.4	2.1	ns
$t_r$	Rise Time (20% to 80%)	0.4	1.9	0.4	2.0	0.4	2.1	ns
$t_f$	Fall Time (80% to 20%)	0.4	1.9	0.4	2.0	0.4	2.1	ns
$f_{max}$	Maximum Operating Frequency	150		150		150		MHz

NOTE: Device will meet the specifications after thermal equilibrium has been established when mounted in a test socket or printed circuit board with maintained transverse airflow greater than 500 lfpm. Electrical parameters are guaranteed only over the declared operating temperature range. Functional operation of the device exceeding these conditions is not implied. Device specification limit values are applied individually under normal operating conditions and not valid simultaneously.

- Propagation delay is measured on this circuit from  $V_{CC}/2$  on the input waveform to the 50% point on the output waveform.

## MC10H352

### ORDERING INFORMATION

Device	Package	Shipping†
MC10H352FN	PLLC-20	46 Units / Rail
MC10H352FNG	PLLC-20 (Pb-Free)	46 Units / Rail
MC10H352FNR2	PLLC-20	500 / Tape & Reel
MC10H352FNR2G	PLLC-20 (Pb-Free)	500 / Tape & Reel
MC10H352P	PDIP-20	18 Unit / Rail
MC10H352PG	PDIP-20 (Pb-Free)	18 Unit / Rail

†For information on tape and reel specifications, including part orientation and tape sizes, please refer to our Tape and Reel Packaging Specifications Brochure, BRD8011/D.

# MC10H352

## PACKAGE DIMENSIONS

20 LEAD PLLC  
CASE 775-02  
ISSUE E

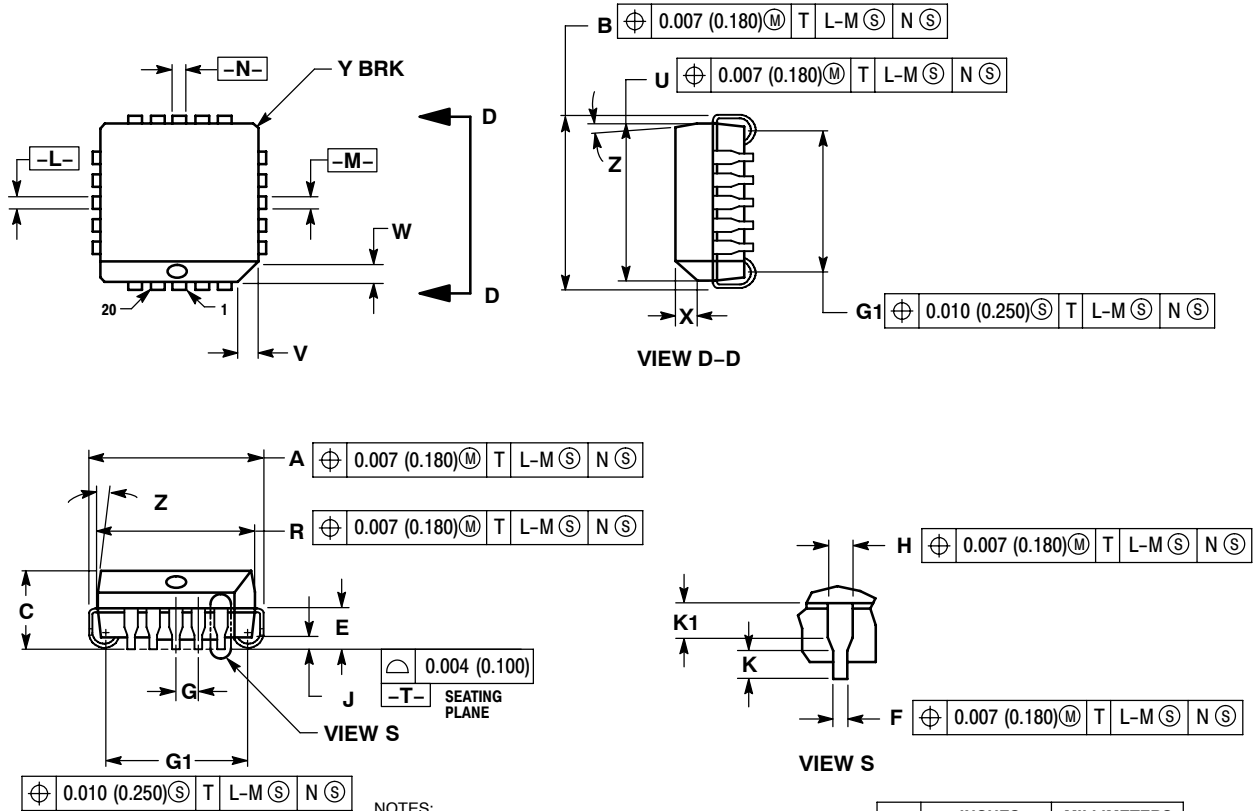

**NOTES:**

1. DIMENSIONS AND TOLERANCING PER ANSI Y14.5M, 1982.
2. DIMENSIONS IN INCHES.
3. DATUMS -L-, -M-, AND -N- DETERMINED WHERE TOP OF LEAD SHOULDER EXITS PLASTIC BODY AT MOLD PARTING LINE.
4. DIMENSION G1, TRUE POSITION TO BE MEASURED AT DATUM -T-, SEATING PLANE.
5. DIMENSIONS R AND U DO NOT INCLUDE MOLD FLASH. ALLOWABLE MOLD FLASH IS 0.010 (0.250) PER SIDE.
6. DIMENSIONS IN THE PACKAGE TOP MAY BE SMALLER THAN THE PACKAGE BOTTOM BY UP TO 0.012 (0.300). DIMENSIONS R AND U ARE DETERMINED AT THE OUTERMOST EXTREMES OF THE PLASTIC BODY EXCLUSIVE OF MOLD FLASH, TIE BAR BURRS, GATE BURRS AND INTERLEAD FLASH, BUT INCLUDING ANY MISMATCH BETWEEN THE TOP AND BOTTOM OF THE PLASTIC BODY.
7. DIMENSION H DOES NOT INCLUDE DAMBAR PROTRUSION OR INTRUSION. THE DAMBAR PROTRUSION(S) SHALL NOT CAUSE THE H DIMENSION TO BE GREATER THAN 0.037 (0.940). THE DAMBAR INTRUSION(S) SHALL NOT CAUSE THE H DIMENSION TO BE SMALLER THAN 0.025 (0.635).

DIM	INCHES		MILLIMETERS	
	MIN	MAX	MIN	MAX
A	0.385	0.395	9.78	10.03
B	0.385	0.395	9.78	10.03
C	0.165	0.180	4.20	4.57
E	0.090	0.110	2.29	2.79
F	0.013	0.019	0.33	0.48
G	0.050 BSC		1.27 BSC	
H	0.026	0.032	0.66	0.81
J	0.020	----	0.51	----
K	0.025	----	0.64	----
R	0.350	0.356	8.89	9.04
U	0.350	0.356	8.89	9.04
V	0.042	0.048	1.07	1.21
W	0.042	0.048	1.07	1.21
X	0.042	0.056	1.07	1.42
Y	----	0.020	----	0.50
Z	2°		10°	
G1	0.310	0.330	7.88	8.38
K1	0.040	----	1.02	----

# MC10H352

## PACKAGE DIMENSIONS

PDIP-20  
P SUFFIX  
PLASTIC DIP PACKAGE  
CASE 738-03  
ISSUE E

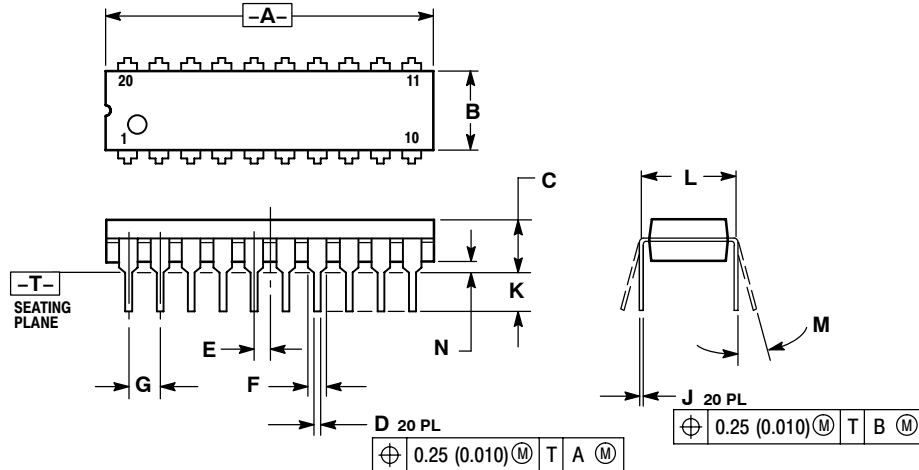

### NOTES:

1. DIMENSIONING AND TOLERANCING PER ANSI Y14.5M, 1982.
2. CONTROLLING DIMENSION: INCH.
3. DIMENSION L TO CENTER OF LEAD WHEN FORMED PARALLEL.
4. DIMENSION B DOES NOT INCLUDE MOLD FLASH.

DIM	INCHES		MILLIMETERS	
	MIN	MAX	MIN	MAX
A	1.010	1.070	25.66	27.17
B	0.240	0.260	6.10	6.60
C	0.150	0.180	3.81	4.57
D	0.015	0.022	0.39	0.55
E	0.050 BSC		1.27 BSC	
F	0.050		1.27	
G	0.100 BSC		2.54 BSC	
J	0.008	0.015	0.21	0.38
K	0.110	0.140	2.80	3.55
L	0.300 BSC		7.62 BSC	
M	0°		15°	
N	0.020	0.040	0.51	1.01

MECL 10H is a trademark of Motorola, Inc.

ON Semiconductor and are registered trademarks of Semiconductor Components Industries, LLC (SCILLC). SCILLC reserves the right to make changes without further notice to any products herein. SCILLC makes no warranty, representation or guarantee regarding the suitability of its products for any particular purpose, nor does SCILLC assume any liability arising out of the application or use of any product or circuit, and specifically disclaims any and all liability, including without limitation special, consequential or incidental damages. "Typical" parameters which may be provided in SCILLC data sheets and/or specifications can and do vary in different applications and actual performance may vary over time. All operating parameters, including "Typicals" must be validated for each customer application by customer's technical experts. SCILLC does not convey any license under its patent rights nor the rights of others. SCILLC products are not designed, intended, or authorized for use as components in systems intended for surgical implant into the body, or other applications intended to support or sustain life, or for any other application in which the failure of the SCILLC product could create a situation where personal injury or death may occur. Should Buyer purchase or use SCILLC products for any such unintended or unauthorized application, Buyer shall indemnify and hold SCILLC and its officers, employees, subsidiaries, affiliates, and distributors harmless against all claims, costs, damages, and expenses, and reasonable attorney fees arising out of, directly or indirectly, any claim of personal injury or death associated with such unintended or unauthorized use, even if such claim alleges that SCILLC was negligent regarding the design or manufacture of the part. SCILLC is an Equal Opportunity/Affirmative Action Employer. This literature is subject to all applicable copyright laws and is not for resale in any manner.

### PUBLICATION ORDERING INFORMATION

**LITERATURE FULFILLMENT:**  
Literature Distribution Center for ON Semiconductor  
P.O. Box 61312, Phoenix, Arizona 85082-1312 USA  
**Phone:** 480-829-7710 or 800-344-3860 Toll Free USA/Canada  
**Fax:** 480-829-7709 or 800-344-3867 Toll Free USA/Canada  
**Email:** orderlit@onsemi.com

**N. American Technical Support:** 800-282-9855 Toll Free  
USA/Canada

**Japan:** ON Semiconductor, Japan Customer Focus Center  
2-9-1 Kamimeguro, Meguro-ku, Tokyo, Japan 153-0051  
**Phone:** 81-3-5773-3850

**ON Semiconductor Website:** <http://onsemi.com>

**Order Literature:** <http://www.onsemi.com/litorder>

For additional information, please contact your local Sales Representative.