



Chipsmall Limited consists of a professional team with an average of over 10 year of expertise in the distribution of electronic components. Based in Hongkong, we have already established firm and mutual-benefit business relationships with customers from,Europe,America and south Asia,supplying obsolete and hard-to-find components to meet their specific needs.

With the principle of “Quality Parts,Customers Priority,Honest Operation,and Considerate Service”,our business mainly focus on the distribution of electronic components. Line cards we deal with include Microchip,ALPS,ROHM,Xilinx,Pulse,ON,Everlight and Freescale. Main products comprise IC,Modules,Potentiometer,IC Socket,Relay,Connector.Our parts cover such applications as commercial,industrial, and automotives areas.

We are looking forward to setting up business relationship with you and hope to provide you with the best service and solution. Let us make a better world for our industry!



Contact us

Tel: +86-755-8981 8866 Fax: +86-755-8427 6832

Email & Skype: info@chipsmall.com Web: www.chipsmall.com

Address: A1208, Overseas Decoration Building, #122 Zhenhua RD., Futian, Shenzhen, China





MBC13917



Package Information
Plastic Package: MLPD-6
1.5 mm x 2.0 mm
Case: 2129-01

Ordering Information

Device	Device Marking or Operating Temperature Range	Package
MBC13917EP	917	MLPD-6

MBC13917

General Purpose SiGe:C RF Cascode Low Noise Amplifier

1 Introduction

The MBC13917 is a cost-effective, high isolation amplifier fabricated with an advanced RF BiCMOS process using the SiGe:C module. This is the leadless package version of the MBC13916 device.

The MBC13917 is designed for a wide range of general purpose RF applications and has excellent high frequency gain and noise figure. On-chip bias circuitry sets the bias point while matching is accomplished off-chip, affording the maximum in application flexibility.

1.1 Features

The MBC13917 has the following features:

- Usable frequency range = 100 MHz to 2500 MHz
- 27 dB typical gain at 434 MHz, $V_{cc} = 2.7V$
- NF_{min} (device level) = 0.95 dB @ 434 MHz
- NF_{min} (device level) = 0.95 dB @ 900 MHz
- 6.5 dBm typical output power at -10 dBm Pin at 900 MHz, $V_{cc} = 2.7V$

Contents

1 Introduction	1
2 Electrical Characteristics	3
3 Scattering and Noise Parameters	6
4 Application Circuits	24
5 Printed Circuit Board and Bill of Materials	33
6 Packaging	37
7 Product Documentation	38
8 Revision History	38

This document contains information on a new product. Specifications and information herein are subject to change without notice.

© Freescale Semiconductor, Inc., 2006–2010. All rights reserved.



- 46 dB typical reverse isolation (device level) at 434 MHz, $V_{CC} = 2.7V$
- 4.7 mA typical bias current at $V_{CC} = 2.7V$
- 2.7V to 3.3V supply
- Industry standard MLPD-6 leadless package
- Available only in tape and reel packaging

1.2 Applications

Ideal for use in any RF product that operates between 100 MHz and 2.5 GHz, and may be applied in:

- Buffer amplifiers
- Mixers
- IF amplifiers
- Voltage controlled oscillators (VCOs)
- Low power amplifiers
- Gain block in RF end products
- Smart metering
- Industrial—scientific and medical (ISM)
- Consumer—WLAN, 802.11 b/g
- Auto—TPMS, RKE, GPS, active antennas, wireless security

Figure 1 shows a simplified block diagram of the MBC13917 with the pinouts and location of the Pin 1 designator on the package.

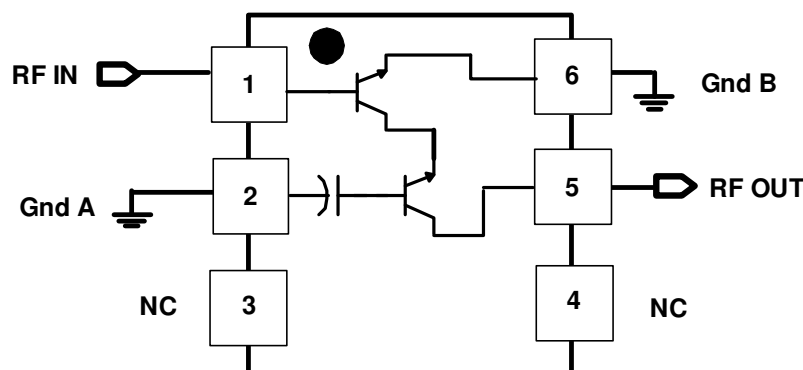

Figure 1. Functional Block Diagram

2 Electrical Characteristics

Table 1 lists the recommended operating conditions of the MBC13917 device.

Table 1. Recommended Operating Conditions

Characteristic	Symbol	Min	Typ	Max	Unit
RF Frequency	f_{RF}	100	—	2500	MHz
Supply Voltage	V_{CC}	2.1	2.7	3.3	Vdc

Table 2. lists the maximum ratings for the device.

Table 2. Maximum Ratings ($T_A = 25^\circ\text{C}$, unless otherwise noted)

Rating	Symbol	Value	Unit
Supply Voltage	V_{CC}	3.5	Vdc
RF Input Power	P_{RF}	10	dBm
Power Dissipation	P_{DIS}	100	mW
Supply Current	I_{CC}	20	mA
Thermal Resistance, Junction to Case	$R_{\theta JC}$	400	$^\circ\text{C}/\text{W}$
Storage Temperature Range	T_{stg}	-65 to 150	$^\circ\text{C}$
Operating Ambient Temperature Range	T_A	-40 to 85	$^\circ\text{C}$
Operating Case Temperature	T_C	-40 to 100	$^\circ\text{C}$

Note: Maximum Ratings and ESD

- Maximum Ratings are those values beyond which damage to the device may occur. Functional operation should be restricted to the limits in the Recommended Operating Conditions and Electrical Characteristics tables.
- ESD (electrostatic discharge) immunity meets Human Body Model (HBM) ≤ 550 V and Machine Model (MM) ≤ 50 V. Additional ESD data is available upon request.

Table 3 lists electrical characteristics associated with noise performance measured in a $50\ \Omega$ system. Additional noise parameters are listed in Table 9.

Table 3. Device Level Characteristics
($V_{CC} = 2.7\text{V}$, $T_A = 25^\circ\text{C}$, measured in S-parameter test fixture, unless otherwise noted)

Characteristic	Symbol	Min	Typ	Max	Unit
Insertion Gain	S21 See note below				dB
f= 350 MHz		21.7	23.7	—	
f= 430 MHz		21.4	23.4	—	
f= 900 MHz		18.7	20.7	—	
f= 1900 MHz		12.6	14.6	—	

Table 3. Device Level Characteristics (continued)
(V_{CC} = 2.7V, T_A = 25°C, measured in S-parameter test fixture, unless otherwise noted)

Characteristic	Symbol	Min	Typ	Max	Unit
Maximum Stable Gain and Maximum Available Gain (Note1)	MSG, MAG				dB
f= 350 MHz		34	36.4	—	
f= 430 MHz		33.2	35.6	—	
f= 900 MHz		26.5	28.9	—	
f= 1900 MHz		15	17.6	—	
Minimum Noise Figure	NF _{min}				dB
f= 350 MHz		—	1.0	1.35	
f= 430 MHz		—	0.95	1.30	
f= 900 MHz		—	0.95	1.30	
f= 1900 MHz		—	1.5	1.85	
Output Third Order Intercept	OIP3				dBm
f= 350 MHz		7.7	9.7	—	
f= 430 MHz		8.3	10.3	—	
f= 900 MHz		11.3	13.3	—	
f= 1900 MHz		11.6	13.6	—	
Reverse Isolation	S12				dB
f= 350 MHz		-49	-53	—	
f= 430 MHz		-48	-52	—	
f= 900 MHz		-42	-46	—	
f= 1900 MHz		-40	-44	—	
Note: Maximum Available Gain and Maximum Stable Gain are defined by the K factor as follows: if K>1, MAG= S21/S12 (K ±SqRt(K2-1)) if K<1, MSG= S21/S12					

Table 4 lists the electrical characteristics measured on evaluation boards tuned for typical application frequencies. Further details on the application circuits are shown in Section 4, “Application Circuits” and details on the boards are shown in Section 5, “Printed Circuit Board and Bill of Materials.”

Table 4. Electrical Characteristics Measured in Frequency-Specific Tuned Circuits
(V_{CC} = 2.7V, T_A = 25°C unless otherwise noted)

Characteristic	Symbol	Min	Typ	Max	Unit
350 MHz (see Figure 16)					
Supply Current	I _{CC}	—	4.7	5.6	mA
RF Gain	G	26.6	27.7	—	dB

Table 4. Electrical Characteristics Measured in Frequency-Specific Tuned Circuits (continued)
(V_{CC} = 2.7V, T_A = 25°C unless otherwise noted)

Characteristic	Symbol	Min	Typ	Max	Unit
Noise Figure	NF	—	2.1	2.5	dB
Output 3rd Order Intercept Point	OIP3	8.0	9.5	—	dBm
Power Output at 1 dB Gain Compression	P _{1dBOutput}	-1	1	—	dBm
Input Return Loss	S11	—	-8	-7	dB
Small Signal Gain	S21	26	27	—	dB
Reverse Isolation	S12	—	-47	-46	dB
Output Return Loss	S22	—	-9	-7.5	dB
370 MHz (see Figure 16)					
Supply Current	I _{CC}	—	4.7	5.6	mA
RF Gain	G	27.5	28.6	—	dB
Noise Figure	NF	—	2.2	2.6	dB
Output 3rd Order Intercept Point	OIP3	9.2	10.7	—	dBm
Power Output at 1 dB Gain Compression	P _{1dBOutput}	0.7	2.2	—	dBm
Input Return Loss	S11	—	-12	-10	dB
Small Signal Gain	S21	27	28.5	—	dB
Reverse Isolation	S12	—	-47	-46	dB
Output Return Loss	S22	—	-12	-10	dB
434 MHz (see Figure 17)					
Supply Current	I _{CC}	—	4.7	5.6	mA
RF Gain	G	26	27	—	dB
Noise Figure	NF	—	2.3	2.65	dB
Output 3rd Order Intercept Point	OIP3	9.5	10.9	—	dBm
Power Output at 1 dB Gain Compression	P _{1dBOutput}	1	2.2	—	dBm
Input Return Loss	S11	—	-15	-10	dB
Small Signal Gain	S21	26	27	—	dB
Reverse Isolation	S12	—	-46	-45	dB
Output Return Loss	S22	—	-19	-16	dB
900 MHz (see Figure 18)					
Supply Current	I _{CC}	—	4.7	5.6	mA
RF Gain	G	22.5	24	—	dB
Noise Figure	NF	—	1.19	1.5	dB

Table 4. Electrical Characteristics Measured in Frequency-Specific Tuned Circuits (continued)
($V_{CC} = 2.7V$, $T_A = 25^\circ C$ unless otherwise noted)

Characteristic	Symbol	Min	Typ	Max	Unit
Output 3rd Order Intercept Point	OIP3	11	12.4	—	dBm
Power Output at 1 dB Gain Compression	$P_{1dBOutput}$	2	3.5	—	dBm
Input Return Loss	S11	—	-10	-9	dB
Small Signal Gain	S21	23	24	—	dB
Reverse Isolation	S12	—	-40	-39	dB
Output Return Loss	S22	—	-23	-16	dB
1900 MHz (see Figure 19)					
Supply Current	I_{CC}	—	4.7	5.6	mA
RF Gain	G	13.5	14.9	—	dB
Noise Figure	NF	—	1.8	2.15	dB
Output 3rd Order Intercept Point	OIP3	7	8.5	—	dBm
Power Output at 1 dB Gain Compression	$P_{1dBOutput}$	-2.5	-1.1	—	dBm
Input Return Loss	S11	—	-13	-10	dB
Small Signal Gain	S21	13.8	14.8	—	dB
Reverse Isolation	S12	—	-42.5	-41.5	dB
Output Return Loss	S22	—	-11.8	-10	dB

3 Scattering and Noise Parameters

Table 5 through Table 8 lists the S parameters for the packaged part in a 50 Ω system at four supply voltage levels.

Table 5. Scattering Parameters
($V_{CC} = 2.7V$, $25^\circ C$, 50 Ω system)

f (MHz)	S11		S21		S12		S22	
	Mag	Ang	Mag	Ang	Mag	Ang	Mag	Ang
100	0.864	-8.1	12.178	169.9	0.001	24.4	0.953	-1.1
150	0.859	-12.4	12.428	165.1	0.001	36.2	0.952	-1.5
200	0.843	-16.2	12.112	160.5	0.001	39.4	0.951	-2.2
250	0.831	-20.6	12.128	156.1	0.002	52.1	0.952	-2.8
300	0.812	-24.5	11.95	151.8	0.002	52.6	0.951	-3.3
350	0.794	-28.3	11.741	147.9	0.002	59.2	0.95	-4
400	0.775	-32.1	11.556	143.8	0.002	64.2	0.947	-4.6
450	0.754	-35.7	11.353	140	0.003	66	0.947	-5.4

Table 5. Scattering Parameters (continued)
(V_{CC} = 2.7V, 25°C, 50Ω system)

f (MHz)	S11		S21		S12		S22	
	Mag	Ang	Mag	Ang	Mag	Ang	Mag	Ang
500	0.709	-39.5	10.954	135.2	0.003	65.2	0.951	-4.7
550	0.694	-42.9	10.587	131.5	0.003	64.8	0.944	-5.5
600	0.671	-46.2	10.212	128	0.003	65.5	0.941	-6.2
650	0.647	-49.5	10.029	124.5	0.004	64.4	0.937	-7.1
700	0.622	-53.1	9.866	121.3	0.004	63.2	0.934	-7.8
750	0.595	-56.1	9.671	117.7	0.004	63.5	0.927	-8.7
800	0.573	-59.2	9.299	114.5	0.004	61	0.918	-9.6
850	0.554	-62.5	9.077	111.4	0.005	61.1	0.911	-10.6
900	0.528	-65.1	8.803	108.4	0.005	57.4	0.907	-11.4
950	0.51	-68	8.535	105.5	0.005	55.2	0.897	-12.2
1000	0.488	-70.6	8.247	102.4	0.005	52.2	0.888	-13.3
1050	0.471	-73.2	7.994	99.7	0.005	50.4	0.881	-14.5
1100	0.453	-75.4	7.698	97	0.005	47	0.871	-15.7
1150	0.436	-77.9	7.443	94.5	0.006	44.3	0.861	-16.8
1200	0.422	-80.4	7.223	91.6	0.005	40.7	0.85	-17.9
1250	0.408	-82.6	6.974	89.1	0.006	36	0.838	-18.9
1300	0.393	-84.6	6.764	86.7	0.005	31.1	0.827	-20.4
1350	0.378	-86.8	6.552	84.1	0.005	27.8	0.815	-21.8
1400	0.367	-88.7	6.29	81.8	0.005	22	0.803	-23
1450	0.355	-90.1	6.094	79.7	0.005	19.9	0.793	-24.3
1500	0.35	-91.9	5.921	77.2	0.005	14.3	0.78	-25.9
1550	0.346	-93.3	5.725	75.7	0.005	10.4	0.769	-27.4
1600	0.342	-95.7	5.513	72.8	0.005	4.5	0.755	-29
1650	0.335	-97.1	5.327	70.7	0.005	-4.6	0.742	-30.5
1700	0.335	-98.9	5.136	68.4	0.005	-9.6	0.73	-32.1
1750	0.326	-100.6	4.957	66.4	0.005	-18.9	0.717	-33.8
1800	0.321	-102.2	4.776	64.2	0.005	-23.7	0.704	-35.6
1850	0.314	-103.6	4.585	62.2	0.005	-24.4	0.689	-37.4
1900	0.312	-103.4	4.432	60.5	0.006	-35.8	0.675	-39.1
1950	0.315	-104.3	4.28	58.5	0.006	-45.6	0.663	-40.7
2000	0.316	-105.1	4.142	56.5	0.007	-54.2	0.651	-42.6

Table 5. Scattering Parameters (continued)
(V_{CC} = 2.7V, 25°C, 50Ω system)

f (MHz)	S11		S21		S12		S22	
	Mag	Ang	Mag	Ang	Mag	Ang	Mag	Ang
2050	0.317	-106	3.994	54.7	0.007	-60.3	0.64	-44.5
2100	0.319	-106.7	3.838	52.8	0.008	-64.9	0.627	-46.3
2150	0.318	-107.2	3.719	50.9	0.008	-70.7	0.616	-48.3
2200	0.321	-107.8	3.568	49.4	0.009	-74.6	0.605	-50.1
2250	0.326	-108.1	3.445	47.3	0.01	-79.8	0.594	-51.9
2300	0.328	-108.2	3.339	45.6	0.011	-85.1	0.584	-53.8
2350	0.333	-108.8	3.185	44.4	0.012	-88	0.577	-55.5
2400	0.339	-109.5	3.067	42.2	0.013	-91.2	0.566	-57.4
2450	0.34	-109.7	2.959	40.7	0.014	-94.1	0.56	-59
2500	0.342	-109.8	2.837	39.3	0.017	-97.7	0.552	-60.7
2550	0.346	-109.1	2.736	38	0.019	-106.2	0.55	-62.6
2600	0.355	-108.9	2.645	36.4	0.018	-112	0.543	-64.8

Table 6. Scattering Parameters
(V_{CC} = 3V, 25°C, 50Ω system)

f (MHz)	S11		S21		S12		S22	
	Mag	Ang	Mag	Ang	Mag	Ang	Mag	Ang
100	0.852	-8.1	13.693	169.6	0.001	16.9	0.952	-1.1
150	0.846	-12.3	13.955	164.7	0.001	32.4	0.951	-1.5
200	0.829	-16.1	13.599	160	0.001	43.8	0.95	-2.1
250	0.814	-20.5	13.595	155.5	0.001	51.5	0.951	-2.7
300	0.794	-24.3	13.377	151.3	0.002	57	0.95	-3.2
350	0.774	-28.1	13.128	147.3	0.002	56.4	0.949	-3.8
400	0.753	-31.8	12.903	143.1	0.002	62.7	0.947	-4.5
450	0.731	-35.3	12.649	139.3	0.002	65.9	0.947	-5.3
500	0.685	-38.9	12.176	134.6	0.003	64.3	0.951	-4.6
550	0.669	-42.2	11.763	130.9	0.003	64.2	0.945	-5.4
600	0.644	-45.3	11.34	127.4	0.003	64.6	0.942	-6.1
650	0.619	-48.5	11.117	123.9	0.003	65.3	0.938	-6.9
700	0.592	-51.8	10.898	120.7	0.004	61.4	0.935	-7.6

Table 6. Scattering Parameters (continued)
(V_{CC} = 3V, 25°C, 50Ω system)

f (MHz)	S11		S21		S12		S22	
	Mag	Ang	Mag	Ang	Mag	Ang	Mag	Ang
750	0.563	-54.5	10.651	117.2	0.004	62.4	0.928	-8.5
800	0.54	-57.4	10.237	114	0.004	60.2	0.919	-9.3
850	0.521	-60.6	9.973	111	0.004	56.5	0.913	-10.4
900	0.494	-62.8	9.657	108	0.005	55.9	0.909	-11.2
950	0.476	-65.4	9.348	105.2	0.005	52.9	0.899	-12
1000	0.454	-67.8	9.03	102.2	0.005	50.8	0.891	-13
1050	0.435	-70.2	8.743	99.6	0.005	46.9	0.883	-14.2
1100	0.418	-72.1	8.414	96.9	0.005	43.5	0.872	-15.4
1150	0.4	-74.3	8.126	94.5	0.005	41.2	0.863	-16.5
1200	0.386	-76.5	7.881	91.7	0.005	35.6	0.853	-17.6
1250	0.372	-78.5	7.606	89.3	0.005	32.7	0.842	-18.6
1300	0.356	-80.2	7.367	86.9	0.005	26	0.83	-20.1
1350	0.341	-82.1	7.13	84.5	0.005	22.9	0.817	-21.4
1400	0.33	-83.8	6.846	82.2	0.005	18.3	0.807	-22.6
1450	0.319	-85	6.631	80.3	0.004	11.5	0.797	-23.9
1500	0.314	-86.6	6.435	77.8	0.004	5.9	0.784	-25.4
1550	0.311	-87.8	6.223	76.3	0.004	2.3	0.773	-27
1600	0.305	-90.1	5.995	73.6	0.004	-6.7	0.759	-28.5
1650	0.299	-91.2	5.793	71.6	0.004	-15.4	0.747	-30
1700	0.299	-93	5.587	69.4	0.005	-19.4	0.734	-31.6
1750	0.289	-94.6	5.395	67.4	0.005	-29.9	0.722	-33.3
1800	0.285	-96.1	5.198	65.2	0.005	-36.4	0.709	-35.2
1850	0.278	-97.4	4.992	63.3	0.005	-36.9	0.695	-36.9
1900	0.276	-97.1	4.823	61.7	0.006	-46.2	0.681	-38.5
1950	0.28	-97.9	4.658	59.8	0.006	-55.1	0.668	-40.2
2000	0.281	-98.6	4.507	57.9	0.007	-62.2	0.657	-42.1
2050	0.282	-99.5	4.349	56.1	0.008	-68.8	0.646	-43.9
2100	0.285	-100.2	4.181	54.3	0.008	-74.9	0.634	-45.7
2150	0.284	-100.7	4.049	52.4	0.009	-76.8	0.621	-47.6
2200	0.287	-101.2	3.889	50.9	0.01	-81.2	0.611	-49.5
2250	0.292	-101.6	3.754	49	0.011	-84.5	0.601	-51.3

Table 6. Scattering Parameters (continued)
(V_{cc} = 3V, 25°C, 50Ω system)

f (MHz)	S11		S21		S12		S22	
	Mag	Ang	Mag	Ang	Mag	Ang	Mag	Ang
2300	0.296	-101.5	3.637	47.3	0.012	-89.2	0.591	-53.1
2350	0.3	-102.3	3.476	46.1	0.013	-92.3	0.583	-54.8
2400	0.307	-103	3.346	44	0.014	-95.2	0.573	-56.7
2450	0.308	-103.1	3.229	42.6	0.015	-97.3	0.566	-58.3
2500	0.31	-103.3	3.097	41.2	0.017	-100.5	0.558	-60
2550	0.316	-102.6	2.989	40	0.019	-108.9	0.557	-61.8
2600	0.326	-102.5	2.89	38.4	0.019	-114.4	0.549	-64.1

Table 7. Scattering Parameters
(V_{cc} = 3.3V, 25°C, 50Ω system)

f (MHz)	S11		S21		S12		S22	
	Mag	Ang	Mag	Ang	Mag	Ang	Mag	Ang
100	0.84	-8.1	15.185	169.4	0.001	13.7	0.949	-1.1
150	0.832	-12.4	15.453	164.4	0.001	28.4	0.949	-1.4
200	0.814	-16.1	15.06	159.6	0.001	45.2	0.949	-2.1
250	0.798	-20.4	15.023	154.9	0.001	47.4	0.95	-2.6
300	0.776	-24.2	14.754	150.6	0.002	50.6	0.948	-3.1
350	0.755	-27.9	14.456	146.6	0.002	58.2	0.948	-3.8
400	0.732	-31.6	14.192	142.4	0.002	62.9	0.947	-4.4
450	0.708	-34.9	13.882	138.5	0.002	64.5	0.946	-5.2
500	0.662	-38.3	13.323	133.7	0.002	62.7	0.95	-4.4
550	0.645	-41.4	12.86	130.1	0.003	61.7	0.944	-5.3
600	0.619	-44.4	12.397	126.7	0.003	63.6	0.942	-5.9
650	0.591	-47.4	12.121	123.2	0.003	62.7	0.939	-6.8
700	0.564	-50.4	11.841	119.9	0.003	60.6	0.934	-7.4
750	0.535	-52.9	11.538	116.5	0.003	60.5	0.927	-8.3
800	0.511	-55.5	11.087	113.4	0.004	58.6	0.92	-9.1
850	0.491	-58.4	10.779	110.4	0.004	58.2	0.914	-10.1
900	0.465	-60.4	10.413	107.5	0.004	54.4	0.909	-10.9
950	0.446	-62.7	10.066	104.7	0.004	53	0.898	-11.8

Table 7. Scattering Parameters (continued)
 (V_{CC} = 3.3V, 25°C, 50Ω system)

f (MHz)	S11		S21		S12		S22	
	Mag	Ang	Mag	Ang	Mag	Ang	Mag	Ang
1000	0.423	-64.8	9.716	101.9	0.004	48.9	0.891	-12.8
1050	0.405	-66.8	9.403	99.3	0.004	46.2	0.884	-13.9
1100	0.387	-68.5	9.042	96.7	0.005	41.3	0.873	-15.1
1150	0.37	-70.3	8.72	94.4	0.004	38.1	0.863	-16.2
1200	0.355	-72.3	8.454	91.7	0.004	33.6	0.854	-17.2
1250	0.341	-73.9	8.155	89.4	0.004	28.5	0.844	-18.2
1300	0.326	-75.3	7.89	87.1	0.004	22.8	0.831	-19.7
1350	0.311	-76.9	7.627	84.7	0.004	19	0.819	-21.1
1400	0.3	-78.3	7.325	82.6	0.004	10.8	0.809	-22.3
1450	0.29	-79.2	7.093	80.7	0.004	5.1	0.8	-23.5
1500	0.285	-80.6	6.881	78.2	0.004	0.1	0.786	-25
1550	0.282	-81.7	6.653	76.8	0.004	-5	0.775	-26.5
1600	0.276	-83.9	6.411	74.2	0.004	-14.1	0.763	-28.1
1650	0.27	-84.8	6.198	72.3	0.004	-23.3	0.751	-29.5
1700	0.27	-86.5	5.978	70.1	0.004	-28.6	0.738	-31.1
1750	0.26	-87.8	5.771	68.2	0.004	-38	0.725	-32.8
1800	0.256	-89.2	5.563	66.1	0.005	-44.4	0.713	-34.7
1850	0.25	-90.5	5.346	64.2	0.005	-46	0.7	-36.4
1900	0.248	-90	5.163	62.6	0.006	-53.4	0.685	-37.9
1950	0.252	-90.9	4.987	60.8	0.007	-62.1	0.672	-39.6
2000	0.253	-91.6	4.824	59	0.007	-69.9	0.661	-41.5
2050	0.255	-92.5	4.658	57.3	0.008	-73.5	0.651	-43.3
2100	0.258	-93.2	4.481	55.5	0.009	-79	0.639	-45
2150	0.258	-93.6	4.336	53.7	0.009	-82.5	0.625	-47
2200	0.261	-94.1	4.169	52.2	0.01	-85.3	0.616	-48.9
2250	0.267	-94.5	4.023	50.4	0.011	-88.8	0.607	-50.6
2300	0.271	-94.5	3.898	48.7	0.012	-92.8	0.596	-52.3
2350	0.275	-95.3	3.73	47.5	0.013	-96.3	0.587	-54.1
2400	0.281	-96.2	3.591	45.6	0.014	-97.7	0.577	-56
2450	0.284	-96.4	3.466	44.2	0.016	-100.2	0.572	-57.6
2500	0.287	-96.6	3.326	42.8	0.018	-102.3	0.564	-59.2

Table 7. Scattering Parameters (continued)
(V_{cc} = 3.3V, 25°C, 50Ω system)

f (MHz)	S11		S21		S12		S22	
	Mag	Ang	Mag	Ang	Mag	Ang	Mag	Ang
2550	0.293	-95.9	3.21	41.6	0.02	-110	0.562	-61
2600	0.304	-96	3.105	40.1	0.02	-114.4	0.554	-63.4

Table 8. Scattering Parameters
(V_{cc} = 3.5V, 25°C, 50Ω system)

f (MHz)	S11		S21		S12		S22	
	Mag	Ang	Mag	Ang	Mag	Ang	Mag	Ang
100	0.84	-8.1	15.185	169.4	0.001	13.7	0.949	-1.1
150	0.832	-12.4	15.453	164.4	0.001	28.4	0.949	-1.4
200	0.814	-16.1	15.06	159.6	0.001	45.2	0.949	-2.1
250	0.798	-20.4	15.023	154.9	0.001	47.4	0.95	-2.6
300	0.776	-24.2	14.754	150.6	0.002	50.6	0.948	-3.1
350	0.755	-27.9	14.456	146.6	0.002	58.2	0.948	-3.8
400	0.732	-31.6	14.192	142.4	0.002	62.9	0.947	-4.4
450	0.708	-34.9	13.882	138.5	0.002	64.5	0.946	-5.2
500	0.662	-38.3	13.323	133.7	0.002	62.7	0.95	-4.4
550	0.645	-41.4	12.86	130.1	0.003	61.7	0.944	-5.3
600	0.619	-44.4	12.397	126.7	0.003	63.6	0.942	-5.9
650	0.591	-47.4	12.121	123.2	0.003	62.7	0.939	-6.8
700	0.564	-50.4	11.841	119.9	0.003	60.6	0.934	-7.4
750	0.535	-52.9	11.538	116.5	0.003	60.5	0.927	-8.3
800	0.511	-55.5	11.087	113.4	0.004	58.6	0.92	-9.1
850	0.491	-58.4	10.779	110.4	0.004	58.2	0.914	-10.1
900	0.465	-60.4	10.413	107.5	0.004	54.4	0.909	-10.9
950	0.446	-62.7	10.066	104.7	0.004	53	0.898	-11.8
1000	0.423	-64.8	9.716	101.9	0.004	48.9	0.891	-12.8
1050	0.405	-66.8	9.403	99.3	0.004	46.2	0.884	-13.9
1100	0.387	-68.5	9.042	96.7	0.005	41.3	0.873	-15.1
1150	0.37	-70.3	8.72	94.4	0.004	38.1	0.863	-16.2
1200	0.355	-72.3	8.454	91.7	0.004	33.6	0.854	-17.2

Table 8. Scattering Parameters (continued)
 (V_{CC} = 3.5V, 25°C, 50Ω system)

f (MHz)	S11		S21		S12		S22	
	Mag	Ang	Mag	Ang	Mag	Ang	Mag	Ang
1250	0.341	-73.9	8.155	89.4	0.004	28.5	0.844	-18.2
1300	0.326	-75.3	7.89	87.1	0.004	22.8	0.831	-19.7
1350	0.311	-76.9	7.627	84.7	0.004	19	0.819	-21.1
1400	0.3	-78.3	7.325	82.6	0.004	10.8	0.809	-22.3
1450	0.29	-79.2	7.093	80.7	0.004	5.1	0.8	-23.5
1500	0.285	-80.6	6.881	78.2	0.004	0.1	0.786	-25
1550	0.282	-81.7	6.653	76.8	0.004	-5	0.775	-26.5
1600	0.276	-83.9	6.411	74.2	0.004	-14.1	0.763	-28.1
1650	0.27	-84.8	6.198	72.3	0.004	-23.3	0.751	-29.5
1700	0.27	-86.5	5.978	70.1	0.004	-28.6	0.738	-31.1
1750	0.26	-87.8	5.771	68.2	0.004	-38	0.725	-32.8
1800	0.256	-89.2	5.563	66.1	0.005	-44.4	0.713	-34.7
1850	0.25	-90.5	5.346	64.2	0.005	-46	0.7	-36.4
1900	0.248	-90	5.163	62.6	0.006	-53.4	0.685	-37.9
1950	0.252	-90.9	4.987	60.8	0.007	-62.1	0.672	-39.6
2000	0.253	-91.6	4.824	59	0.007	-69.9	0.661	-41.5
2050	0.255	-92.5	4.658	57.3	0.008	-73.5	0.651	-43.3
2100	0.258	-93.2	4.481	55.5	0.009	-79	0.639	-45
2150	0.258	-93.6	4.336	53.7	0.009	-82.5	0.625	-47
2200	0.261	-94.1	4.169	52.2	0.01	-85.3	0.616	-48.9
2250	0.267	-94.5	4.023	50.4	0.011	-88.8	0.607	-50.6
2300	0.271	-94.5	3.898	48.7	0.012	-92.8	0.596	-52.3
2350	0.275	-95.3	3.73	47.5	0.013	-96.3	0.587	-54.1
2400	0.281	-96.2	3.591	45.6	0.014	-97.7	0.577	-56
2450	0.284	-96.4	3.466	44.2	0.016	-100.2	0.572	-57.6
2500	0.287	-96.6	3.326	42.8	0.018	-102.3	0.564	-59.2
2550	0.293	-95.9	3.21	41.6	0.02	-110	0.562	-61
2600	0.304	-96	3.105	40.1	0.02	-114.4	0.554	-63.4

Table 9 lists the noise parameters for the packaged part as measured in a 50 Ω system.

Table 9. Noise Parameters
(50Ω system)

Freq	Fmin	Gamma Opt		Rn	Ga
MHz	dB	Mag	Angle		dB
Vcc = 2.7 V, Icc = 4.7 mA, 25°C					
100	1.14	0.154	63.1	0.17	34.78
300	1.01	0.153	50.4	0.16	33.08
500	0.93	0.152	46.2	0.15	31.16
700	0.91	0.151	49.1	0.14	29.05
900	0.95	0.151	57.3	0.13	26.83
1000	0.99	0.152	63	0.13	25.69
1200	1.09	0.156	76.5	0.13	23.38
1400	1.193	0.164	91.6	0.12	21.09
1600	1.28	0.178	106.6	0.12	18.87
1900	1.515	0.21	125.6	0.12	15.78
2000	1.61	0.225	130.3	0.12	14.84
2200	1.84	0.262	135.8	0.13	13.15
2400	2.12	0.308	135.1	0.14	11.74
Vcc = 3.0 V, Icc = 5.3 mA, 25°C					
100	1.18	0.127	83	0.16	35.42
300	1.05	0.125	65.4	0.15	33.81
500	0.96	0.124	57.8	0.14	31.93
700	0.91	0.123	58.3	0.13	29.86
900	0.95	0.125	65.2	0.13	27.63
1000	0.98	0.127	70.4	0.12	26.48
1200	1.07	0.133	83.5	0.12	24.16
1400	1.153	0.143	98.4	0.12	21.83
1600	1.24	0.159	113.3	0.11	19.57
1900	1.455	0.194	132	0.11	16.44
2000	1.54	0.209	136.2	0.12	15.49
2200	1.76	0.246	140.6	0.12	13.79
2400	2.03	0.291	137.8	0.13	12.39
Vcc = 3.3 V, Icc = 6.1 mA, 25°C					
100	1.20	0.122	-4.7	0.2	34.43

Table 9. Noise Parameters (continued)
(50 Ω system)

Freq	Fmin	Gamma Opt		Rn	Ga
		Mag	Angle		
MHz	dB				dB
300	1.05	0.112	171.7	0.11	33.33
500	0.95	0.105	-57.8	0.14	31.86
700	0.90	0.102	33.5	0.14	30.07
900	0.93	0.104	92.1	0.11	28.06
1000	0.96	0.106	111	0.11	26.99
1200	1.04	0.114	132.6	0.1	24.76
1400	1.12	0.127	137.5	0.1	22.48
1600	1.20	0.146	132.5	0.1	20.22
1900	1.41	0.184	120.3	0.12	17.02
2000	1.49	0.2	118.3	0.13	16.04
2200	1.71	0.236	122.1	0.14	14.27
2400	1.97	0.279	141.9	0.12	12.81
Vcc = 3.5 V, Icc = 6.7 mA, 25°C					
100	1.20	0.126	121	0.14	36.11
300	1.05	0.108	98.2	0.14	34.63
500	0.95	0.096	86.1	0.13	32.83
700	0.90	0.091	82.9	0.12	30.79
900	0.92	0.092	86.6	0.12	28.58
1000	0.95	0.095	90.4	0.11	27.43
1200	1.02	0.104	101	0.11	25.09
1400	1.10	0.12	113.7	0.11	22.73
1600	1.18	0.141	126.7	0.11	20.44
1900	1.38	0.181	142.4	0.1	17.26
2000	1.47	0.198	145.7	0.11	16.3
2200	1.68	0.233	148	0.11	14.59
2400	1.94	0.274	142.9	0.12	13.21

Figure 2 through Figure 5 are the constant noise figure and gain circles with input and output stability regions shown on Smith charts. Gamma opt, noise resistance and stability at the frequency are shown for two values of the external bias resistor at 350 MHz, 450 MHz, 900 MHz, and 1900 MHz.

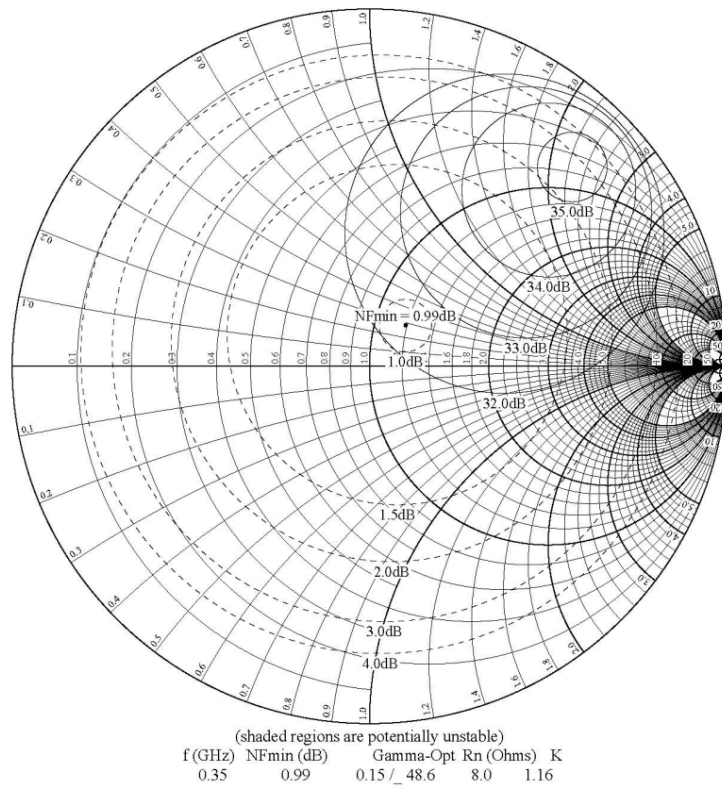

Figure 2. Constant Noise Figure and Gain Circles: 350 MHz

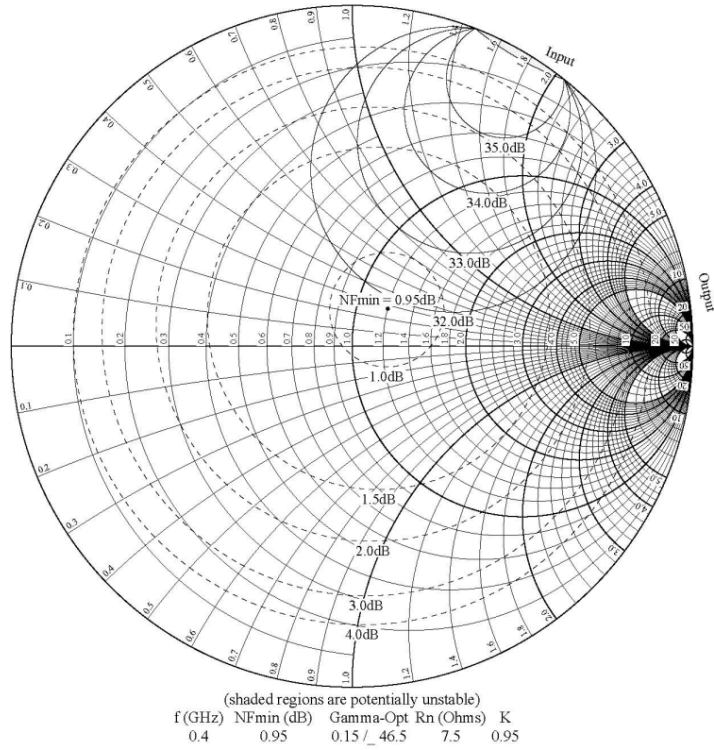

Figure 3. Constant Noise Figure and Gain Circles: 450 MHz

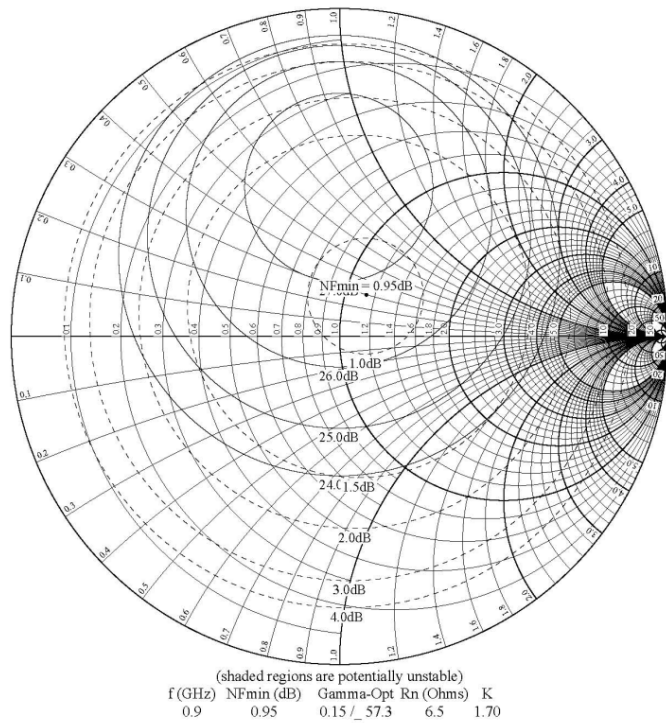

Figure 4. Constant Noise Figure and Gain Circles: 900 MHz

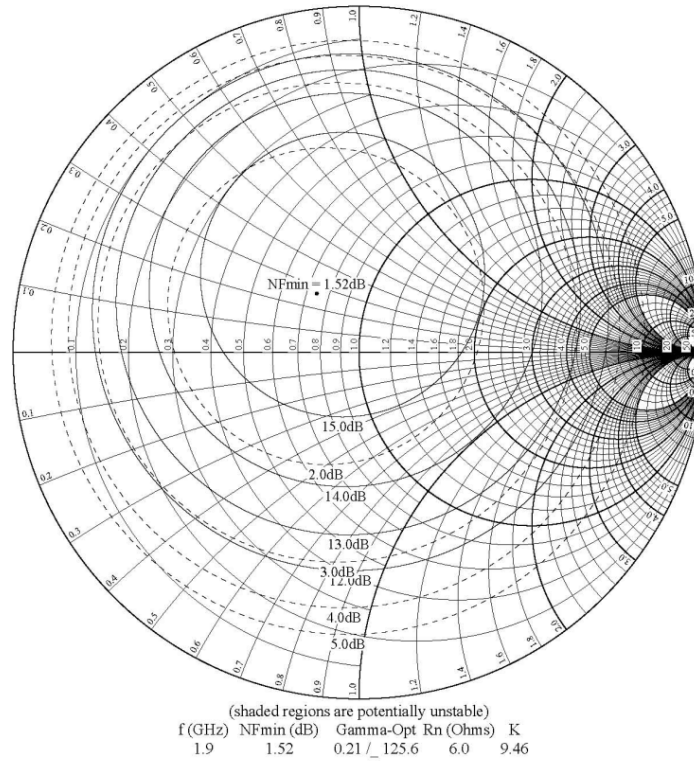

Figure 5. Constant Noise Figure and Gain Circles: 1900 MHz

Figure 6 shows minimum noise figure and associated gain versus frequency for the packaged device in a 50 Ω system at four bias levels.

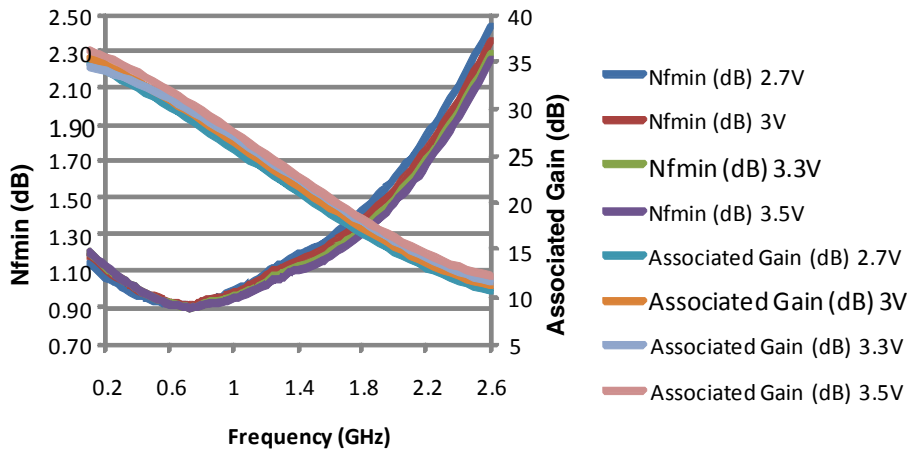

Figure 6. Minimum Noise Figure and Associated Gain vs. Frequency at 25°C

Figure 7 shows minimum noise figure versus frequency over temperature for the packaged device in a 50 Ω system.

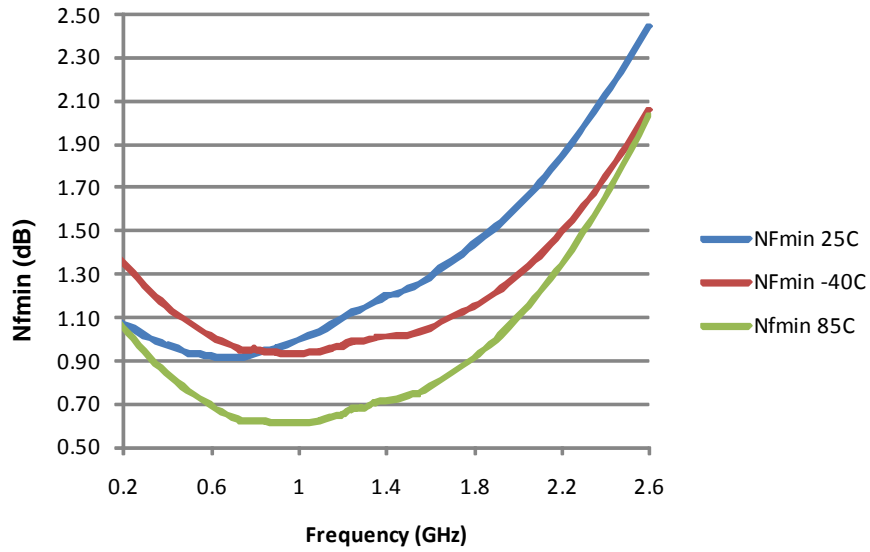

Figure 7. Minimum Noise Figure vs. Frequency and Temperature

Figure 8 shows maximum stable and available gain and forward insertion gain for the packaged device in a 50 Ω system over frequency.

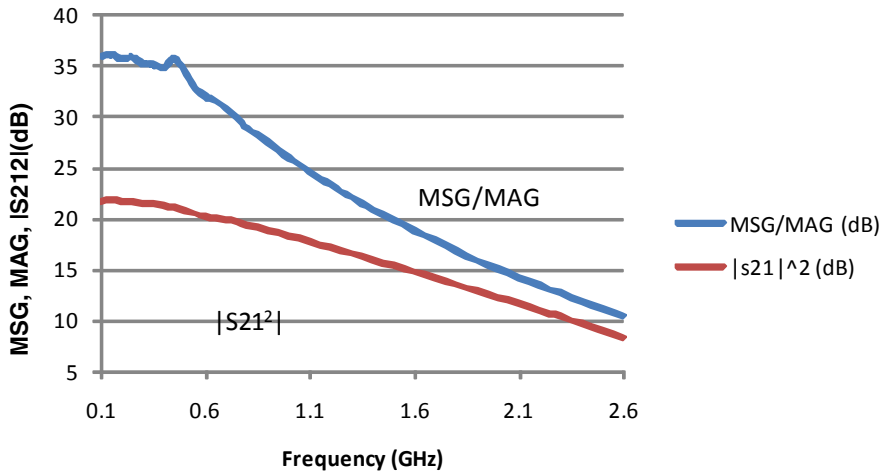

Figure 8. Maximum Stable Gain/Maximum Available Gain and Forward Insertion Gain vs. Frequency at 25°C

Figure 9 shows power out versus power in the 350 MHz application circuit at four bias levels.

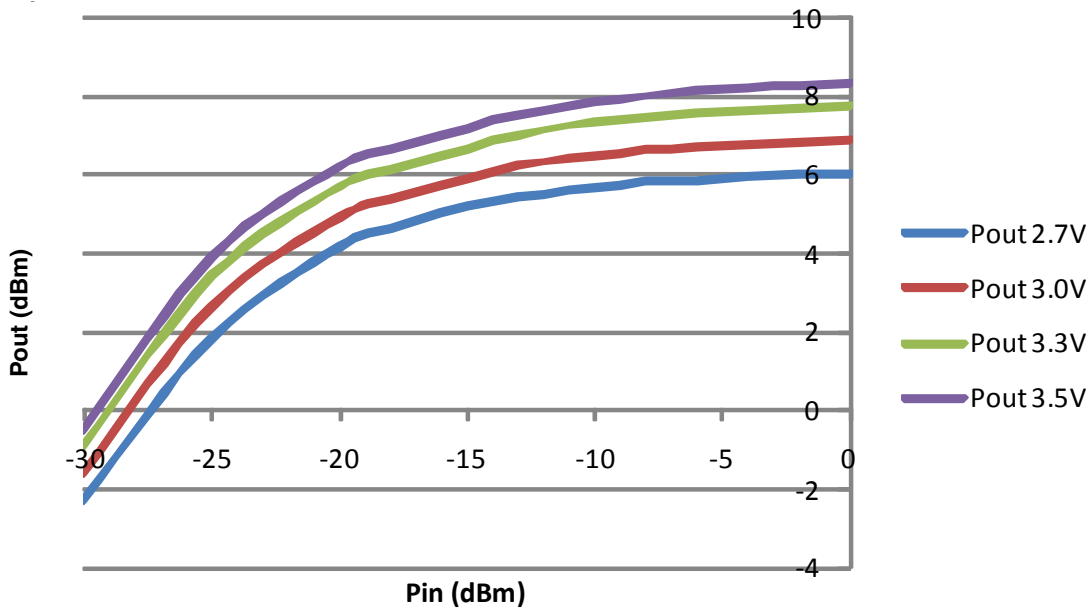

Figure 9. Output Power vs. Input Power for 350 MHz at 25°C

Figure 10 shows power out versus power in the 900 MHz application circuit at four bias levels.

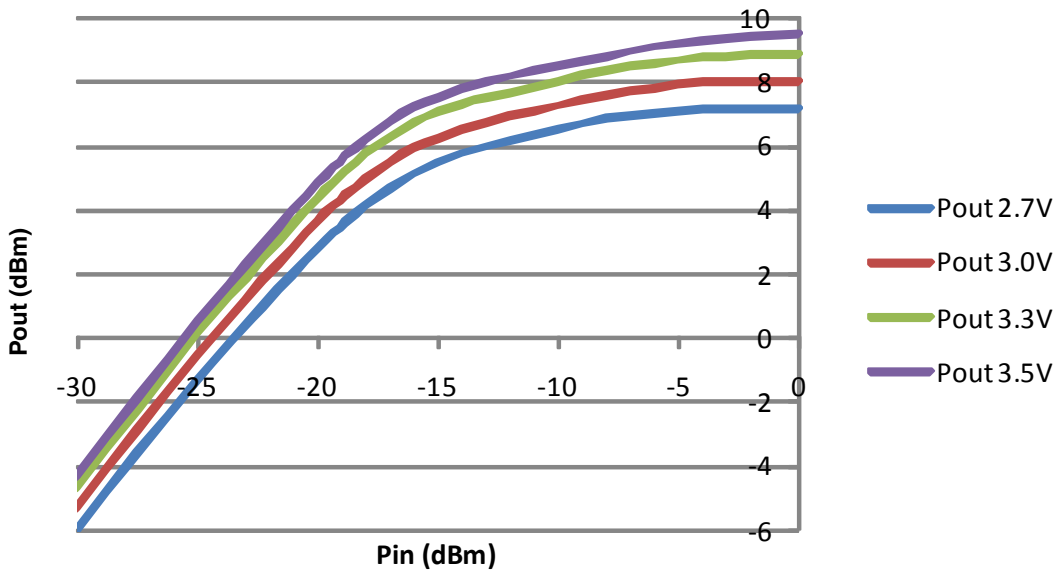

Figure 10. Output Power vs. Input Power for 900 MHz at 25°C

Figure 11 shows power out versus power in the 1900 MHz application circuit at four bias levels.

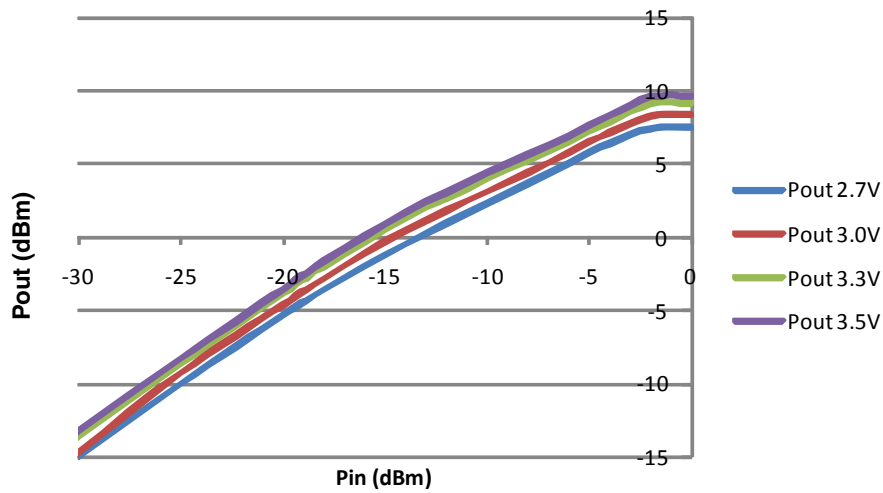

Figure 11. Output Power vs. Input Power for 1900 MHz at 25°C

Figure 12 shows supply current versus power in and bias in the 350 MHz application circuit at four bias levels.

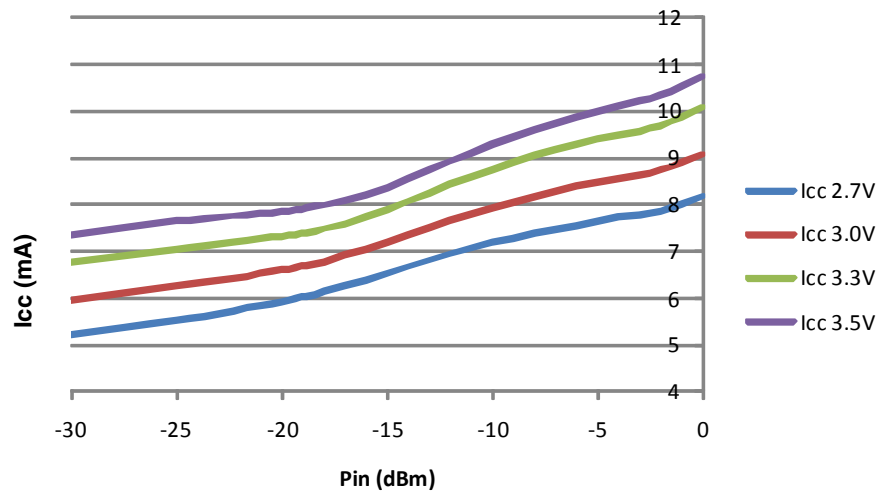

Figure 12. Supply Current vs. Input Power for 350 MHz at 25°C

Figure 13 shows supply current versus power in and bias in the 900 MHz application circuit at four bias levels.

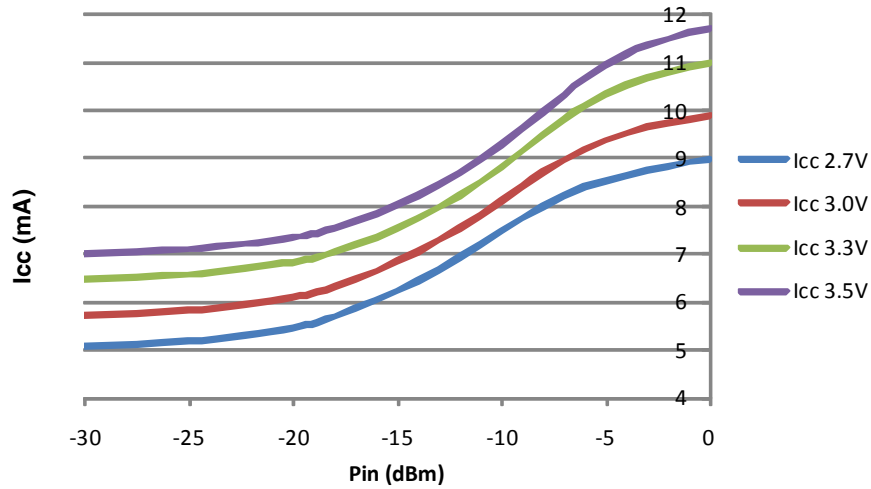

Figure 13. Supply Current vs. Input Power for 900 MHz at 25°C

Figure 14 shows supply current versus power in and bias in the 1900 MHz application circuit at four bias levels.

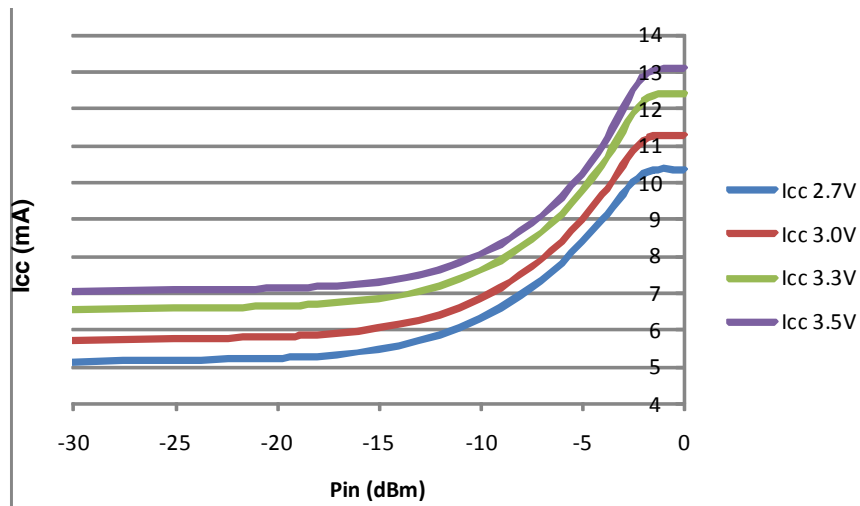

Figure 14. Supply Current vs. Input Power for 1900 MHz at 25°C

Figure 15 shows maximum unilateral gain versus frequency at four bias levels.

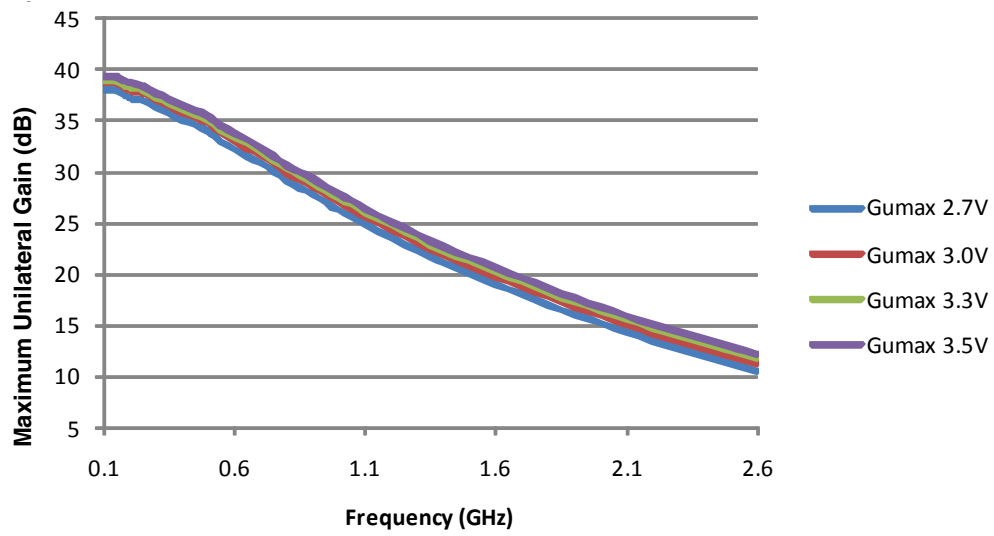

Figure 15. Maximum Unilateral Gain vs. Frequency and Bias at 25°C

4 Application Circuits

The MBC13917 LNA is designed for applications in the 100 MHz to 2.5 GHz range. In the application examples included in this section, a balance is made between competing RF performance characteristics of I_{cc} , NF, gain IP3, and return losses to demonstrate overall performance. Conjugate matching is not used for the input or output.

Instead, matching that achieves a tradeoff in RF performance qualities is shown. For a particular application or specification requirement, the matching can be changed to achieve enhanced performance of one parameter (generally at the expense of other parameters). Application information for 350 MHz, 434 MHz, 900 MHz and 1900 MHz circuits is provided.

- [Section 3, “Scattering and Noise Parameters”](#) provides Smith charts with gain and noise circles for each application frequency.
- [Section 5, “Printed Circuit Board and Bill of Materials”](#) provides the evaluation board layout and Bill of Material for the circuits.

4.1 350 MHz–370 MHz Applications

This application circuit was designed to provide NF = 2.1 dB, S21 gain > 27 dB for 350 MHz. Return losses and gain are similar for 350 MHz–370 MHz.

- Component C4 has the greatest impact on return losses, NF, and gain, by moving the input and output on the Smith chart.
- Component L1 can be lowered to improve NF, by trading off S11 return loss.
- Gain, OIP3 and P1dBoutput can be increased, by decreasing the resistor value at the output (without impacting NF or return losses).

This application is intended for a range of designs, including TETRA land mobile and base station transceivers. Typical performance that can be expected from this circuit at 2.7V is listed in [Table 10](#).

[Figure 16](#) is the 350 MHz–370 MHz application schematic with package pinouts and the circuit component topology.

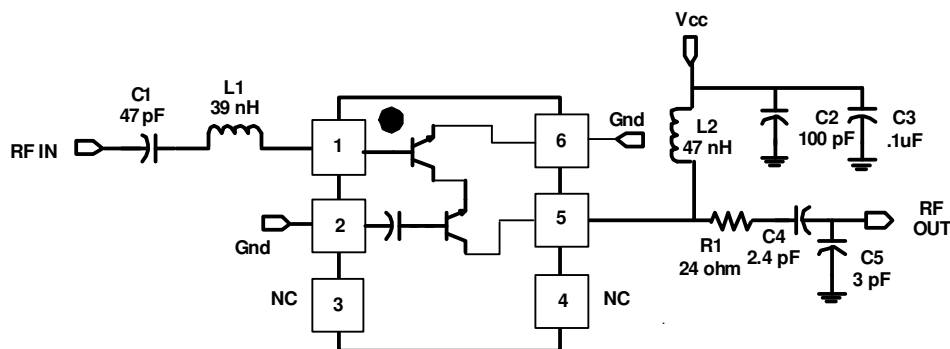

Figure 16. 350 MHz–370 MHz Application Schematic

Table 10 provides the electrical characteristics for the 350 MHz–370 MHz application.

Table 10. Typical 350–370 MHz Evaluation Board Performance

	Characteristic	Symbol	Min	Typ	Max	Unit
350 MHz (Figure 16) $V_{CC} 2.7V$ $T_A = 25^\circ C$	Supply Current	I_{CC}	—	4.7	5.6	mA
	RF Gain	G	26.6	27.7	—	dB
	Noise Figure	NF	—	2.1	2.5	dB
	Output 3rd Order Intercept Point	OIP3	8	9.5	—	dBm
	Power Output at 1 dB Gain Compression	$P_{1dB\text{Output}}$	-1	1	—	dBm
	Input Return Loss	S11	—	-8	-7	dB
	Small Signal Gain	S21	26	27	—	dB
	Reverse Isolation	S12	—	-47	-46	dB
	Output Return Loss	S22	—	-9	-7.5	dB

370 MHz (Figure 16) $V_{CC} 2.7V$ $T_A = 25^\circ C$	Supply Current	I_{CC}	—	4.7	5.6	mA
	RF Gain	G	27.5	28.6	—	dB
	Noise Figure	NF	—	2.2	2.6	dB
	Output 3rd Order Intercept Point	OIP3	9.2	10.7	—	dBm
	Power Output at 1 dB Gain Compression	$P_{1dB\text{Output}}$	0.7	2.2	—	dBm
	Input Return Loss	S11	—	-12	-10	dB
	Small Signal Gain	S21	27	28.5	—	dB
	Reverse Isolation	S12	—	-47	-46	dB
	Output Return Loss	S22	—	-12	-10	dB

350 MHz (Figure 16) $V_{CC} 2.7V$ $T_A = 85^\circ C$	Supply Current	I_{CC}	—	5.3	6.2	mA
	RF Gain	G	25.6	26.7	—	dB
	Noise Figure	NF	—	2.4	2.75	dB
	Output 3rd Order Intercept Point	OIP3	9.2	10.7	—	dBm
	Power Output at 1 dB Gain Compression	$P_{1dB\text{Output}}$	0	1.8	—	dBm
	Input Return Loss	S11	—	-8	-7	dB
	Small Signal Gain	S21	25.5	26.6	—	dB
	Reverse Isolation	S12	—	-47.5	-46.5	dB
	Output Return Loss	S22	—	-9.7	-8	dB