



Chipsmall Limited consists of a professional team with an average of over 10 year of expertise in the distribution of electronic components. Based in Hongkong, we have already established firm and mutual-benefit business relationships with customers from,Europe,America and south Asia,supplying obsolete and hard-to-find components to meet their specific needs.

With the principle of "Quality Parts,Customers Priority,Honest Operation,and Considerate Service",our business mainly focus on the distribution of electronic components. Line cards we deal with include Microchip,ALPS,ROHM,Xilinx,Pulse,ON,Everlight and Freescale. Main products comprise IC,Modules,Potentiometer,IC Socket,Relay,Connector.Our parts cover such applications as commercial,industrial, and automotives areas.

We are looking forward to setting up business relationship with you and hope to provide you with the best service and solution. Let us make a better world for our industry!



## Contact us

Tel: +86-755-8981 8866 Fax: +86-755-8427 6832

Email & Skype: info@chipsmall.com Web: www.chipsmall.com

Address: A1208, Overseas Decoration Building, #122 Zhenhua RD., Futian, Shenzhen, China



# MC33078, MC33079, NCV33078, NCV33079

## Low Noise Dual/Quad Operational Amplifiers

The MC33078/9 series is a family of high quality monolithic amplifiers employing Bipolar technology with innovative high performance concepts for quality audio and data signal processing applications. This family incorporates the use of high frequency PNP input transistors to produce amplifiers exhibiting low input voltage noise with high gain bandwidth product and slew rate. The all NPN output stage exhibits no deadband crossover distortion, large output voltage swing, excellent phase and gain margins, low open loop high frequency output impedance and symmetrical source and sink AC frequency performance.

The MC33078/9 family offers both dual and quad amplifier versions and is available in the plastic DIP and SOIC packages (P and D suffixes).

### Features

- Dual Supply Operation:  $\pm 5.0$  V to  $\pm 18$  V
- Low Voltage Noise:  $4.5$  nV/ $\sqrt{\text{Hz}}$
- Low Input Offset Voltage:  $0.15$  mV
- Low T.C. of Input Offset Voltage:  $2.0$   $\mu\text{V}/^\circ\text{C}$
- Low Total Harmonic Distortion:  $0.002\%$
- High Gain Bandwidth Product:  $16$  MHz
- High Slew Rate:  $7.0$  V/ $\mu\text{s}$
- High Open Loop AC Gain:  $800$  @  $20$  kHz
- Excellent Frequency Stability
- Large Output Voltage Swing:  $+14.1$  V/  $-14.6$  V
- ESD Diodes Provided on the Inputs
- NCV Prefix for Automotive and Other Applications Requiring Unique Site and Control Change Requirements
- These Devices are Pb-Free, Halogen Free/BFR Free and are RoHS Compliant

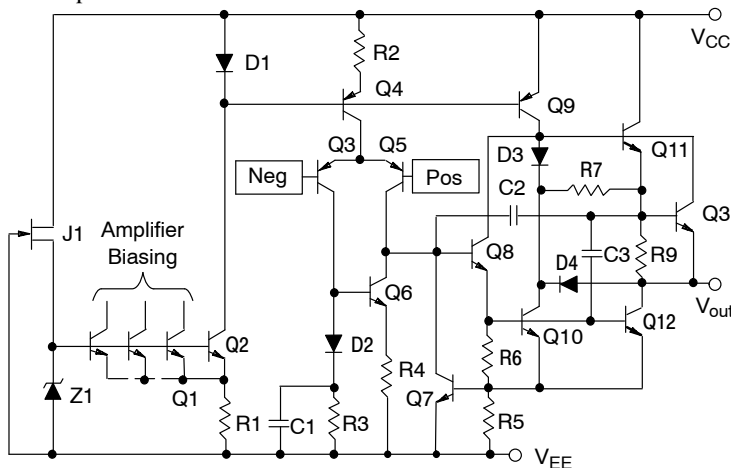

Figure 1. Representative Schematic Diagram  
(Each Amplifier)



ON Semiconductor®

<http://onsemi.com>

### MARKING DIAGRAMS

#### DUAL

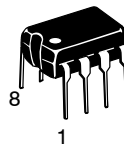

PDIP-8  
P SUFFIX  
CASE 626

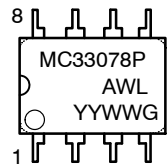

SOIC-8  
D SUFFIX  
CASE 751

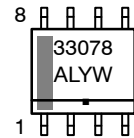

#### QUAD

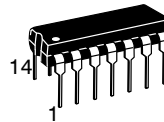

PDIP-14  
P SUFFIX  
CASE 646

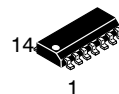
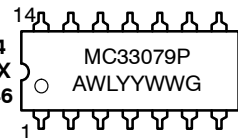

SOIC-14  
D SUFFIX  
CASE 751A

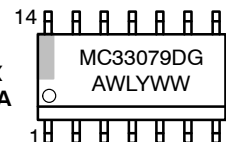

A = Assembly Location  
WL, L = Wafer Lot  
YY, Y = Year  
WW, W = Work Week  
G or ■ = Pb-Free Package

### ORDERING INFORMATION

See detailed ordering and shipping information in the package dimensions section on page 10 of this data sheet.

# MC33078, MC33079, NCV33078, NCV33079

## PIN CONNECTIONS

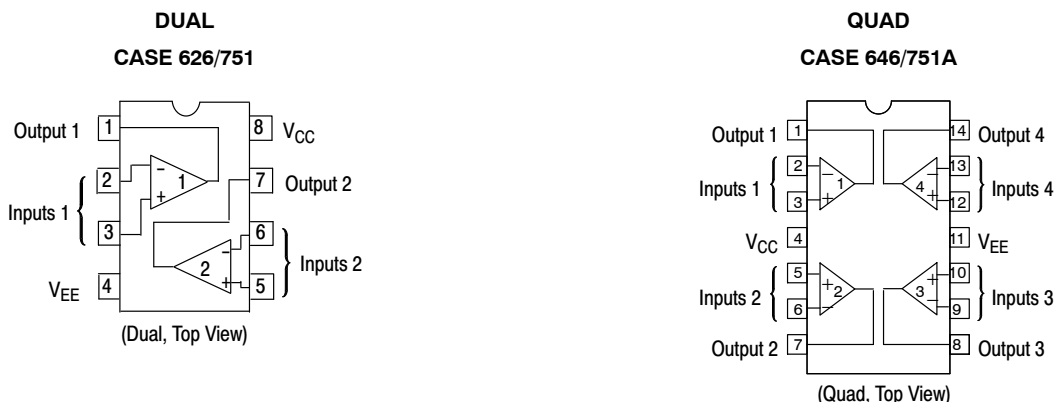

### MAXIMUM RATINGS

Rating	Symbol	Value	Unit
Supply Voltage ( $V_{CC}$ to $V_{EE}$ )	$V_S$	+36	V
Input Differential Voltage Range	$V_{IDR}$	Note 1	V
Input Voltage Range	$V_{IR}$	Note 1	V
Output Short Circuit Duration (Note 2)	$t_{SC}$	Indefinite	sec
Maximum Junction Temperature	$T_J$	+150	°C
Storage Temperature	$T_{stg}$	-60 to +150	°C
ESD Protection at any Pin MC33078/NCV33078 MC33079/NCV33079	$V_{esd}$	600 200 550 150	V
Maximum Power Dissipation	$P_D$	Note 2	mW
Operating Temperature Range	$T_A$	-40 to +85	°C

Stresses exceeding Maximum Ratings may damage the device. Maximum Ratings are stress ratings only. Functional operation above the Recommended Operating Conditions is not implied. Extended exposure to stresses above the Recommended Operating Conditions may affect device reliability.

1. Either or both input voltages must not exceed the magnitude of  $V_{CC}$  or  $V_{EE}$ .
2. Power dissipation must be considered to ensure maximum junction temperature ( $T_J$ ) is not exceeded (see Figure 2).

# MC33078, MC33079, NCV33078, NCV33079

**DC ELECTRICAL CHARACTERISTICS** ( $V_{CC} = +15\text{ V}$ ,  $V_{EE} = -15\text{ V}$ ,  $T_A = 25^\circ\text{C}$ , unless otherwise noted.)

Characteristics	Symbol	Min	Typ	Max	Unit
Input Offset Voltage ( $R_S = 10\ \Omega$ , $V_{CM} = 0\text{ V}$ , $V_O = 0\text{ V}$ ) (MC33078) $T_A = +25^\circ\text{C}$ $T_A = -40^\circ$ to $+85^\circ\text{C}$ (MC33079) $T_A = +25^\circ\text{C}$ $T_A = -40^\circ$ to $+85^\circ\text{C}$	$ V_{IO} $	-	0.15	2.0	mV
		-	-	3.0	
		-	0.15	2.5	
		-	-	3.5	
Average Temperature Coefficient of Input Offset Voltage $R_S = 10\ \Omega$ , $V_{CM} = 0\text{ V}$ , $V_O = 0\text{ V}$ , $T_A = T_{low}$ to $T_{high}$	$\Delta V_{IO}/\Delta T$	-	2.0	-	$\mu\text{V}/^\circ\text{C}$
Input Bias Current ( $V_{CM} = 0\text{ V}$ , $V_O = 0\text{ V}$ ) $T_A = +25^\circ\text{C}$ $T_A = -40^\circ$ to $+85^\circ\text{C}$	$I_{IB}$	-	300	750	nA
		-	-	800	
Input Offset Current ( $V_{CM} = 0\text{ V}$ , $V_O = 0\text{ V}$ ) $T_A = +25^\circ\text{C}$ $T_A = -40^\circ$ to $+85^\circ\text{C}$	$I_{IO}$	-	25	150	nA
		-	-	175	
Common Mode Input Voltage Range ( $\Delta V_{IO} = 5.0\text{ mV}$ , $V_O = 0\text{ V}$ )	$V_{ICR}$	$\pm 13$	$\pm 14$	-	V
Large Signal Voltage Gain ( $V_O = \pm 10\text{ V}$ , $R_L = 2.0\text{ k}\Omega$ ) $T_A = +25^\circ\text{C}$ $T_A = -40^\circ$ to $+85^\circ\text{C}$	$A_{VOL}$	90	110	-	dB
		85	-	-	
Output Voltage Swing ( $V_{ID} = \pm 1.0\text{ V}$ ) $R_L = 600\ \Omega$ $R_L = 600\ \Omega$ $R_L = 2.0\text{ k}\Omega$ $R_L = 2.0\text{ k}\Omega$ $R_L = 10\text{ k}\Omega$ $R_L = 10\text{ k}\Omega$	$V_{O+}$ $V_{O-}$ $V_{O+}$ $V_{O-}$ $V_{O+}$ $V_{O-}$	-	+10.7	-	V
		-	-11.9	-	
		+13.2	+13.8	-	
		-	-13.7	-13.2	
		+13.5	+14.1	-	
		-	-14.6	-14	
Common Mode Rejection ( $V_{in} = \pm 13\text{ V}$ )	CMR	80	100	-	dB
Power Supply Rejection (Note 3) $V_{CC}/V_{EE} = +15\text{ V}/-15\text{ V}$ to $+5.0\text{ V}/-5.0\text{ V}$	PSR	80	105	-	dB
Output Short Circuit Current ( $V_{ID} = 1.0\text{ V}$ , Output to Ground) Source Sink	$I_{SC}$	+15 -20	+29 -37	- -	mA
Power Supply Current ( $V_O = 0\text{ V}$ , All Amplifiers) (MC33078) $T_A = +25^\circ\text{C}$ $T_A = -40^\circ$ to $+85^\circ\text{C}$ (MC33079) $T_A = +25^\circ\text{C}$ $T_A = -40^\circ$ to $+85^\circ\text{C}$	$I_D$	-	4.1	5.0	mA
		-	-	5.5	
		-	8.4	10	
		-	-	11	

3. Measured with  $V_{CC}$  and  $V_{EE}$  differentially varied simultaneously.

# MC33078, MC33079, NCV33078, NCV33079

**AC ELECTRICAL CHARACTERISTICS** ( $V_{CC} = +15\text{ V}$ ,  $V_{EE} = -15\text{ V}$ ,  $T_A = 25^\circ\text{C}$ , unless otherwise noted.)

Characteristics	Symbol	Min	Typ	Max	Unit
Slew Rate ( $V_{in} = -10\text{ V to } +10\text{ V}$ , $R_L = 2.0\text{ k}\Omega$ , $C_L = 100\text{ pF}$ , $A_V = +1.0$ )	SR	5.0	7.0	–	V/ $\mu\text{s}$
Gain Bandwidth Product ( $f = 100\text{ kHz}$ )	GBW	10	16	–	MHz
Unity Gain Bandwidth (Open Loop)	BW	–	9.0	–	MHz
Gain Margin ( $R_L = 2.0\text{ k}\Omega$ $C_L = 0\text{ pF}$ $C_L = 100\text{ pF}$ )	$A_m$	– –	–11 –6.0	– –	dB
Phase Margin ( $R_L = 2.0\text{ k}\Omega$ $C_L = 0\text{ pF}$ $C_L = 100\text{ pF}$ )	$\phi_m$	– –	55 40	– –	Deg
Channel Separation ( $f = 20\text{ Hz to } 20\text{ kHz}$ )	CS	–	–120	–	dB
Power Bandwidth ( $V_O = 27\text{ V}_{pp}$ , $R_L = 2.0\text{ k}\Omega$ , THD $\pm 1.0\%$ )	$BW_p$	–	120	–	kHz
Total Harmonic Distortion ( $R_L = 2.0\text{ k}\Omega$ , $f = 20\text{ Hz to } 20\text{ kHz}$ , $V_O = 3.0\text{ V}_{rms}$ , $A_V = +1.0$ )	THD	–	0.002	–	%
Open Loop Output Impedance ( $V_O = 0\text{ V}$ , $f = 9.0\text{ MHz}$ )	$ Z_O $	–	37	–	$\Omega$
Differential Input Resistance ( $V_{CM} = 0\text{ V}$ )	$R_{in}$	–	175	–	$\text{k}\Omega$
Differential Input Capacitance ( $V_{CM} = 0\text{ V}$ )	$C_{in}$	–	12	–	pF
Equivalent Input Noise Voltage ( $R_S = 100\ \Omega$ , $f = 1.0\text{ kHz}$ )	$e_n$	–	4.5	–	$\text{nV}/\sqrt{\text{Hz}}$
Equivalent Input Noise Current ( $f = 1.0\text{ kHz}$ )	$i_n$	–	0.5	–	$\text{Hz}\sqrt{\text{pA}}$

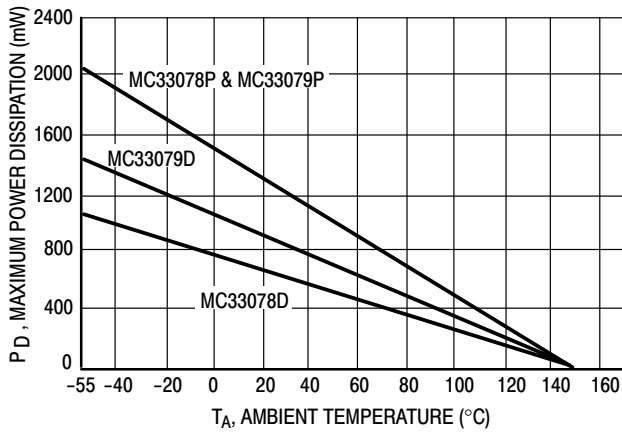

**Figure 2. Maximum Power Dissipation versus Temperature**

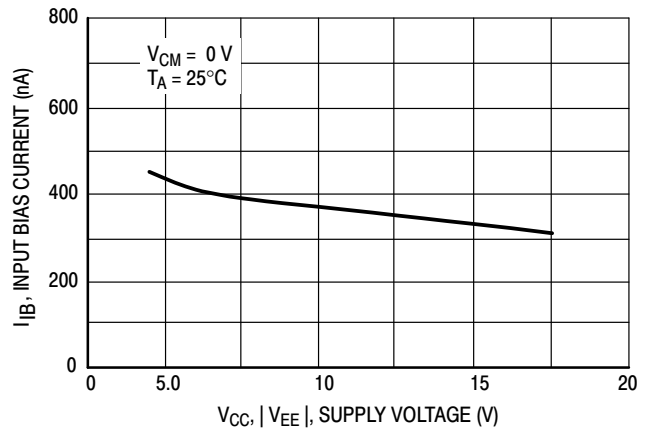

**Figure 3. Input Bias Current versus Supply Voltage**

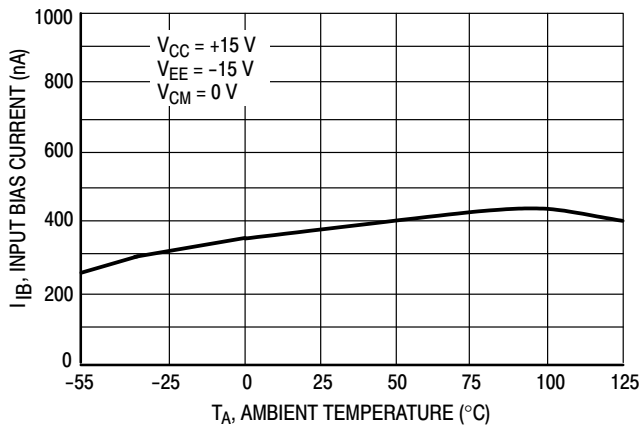

**Figure 4. Input Bias Current versus Temperature**

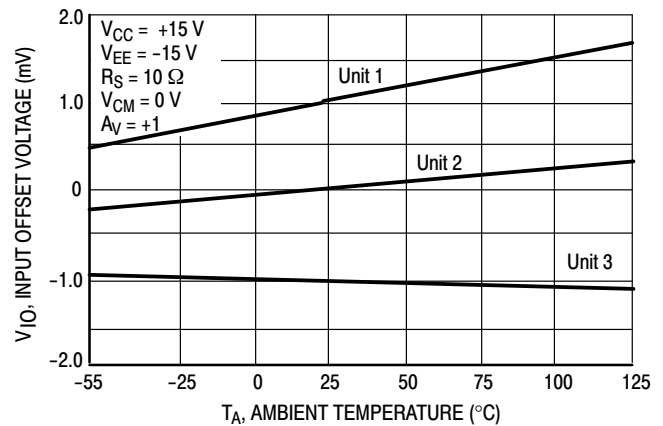

**Figure 5. Input Offset Voltage versus Temperature**

MC33078, MC33079, NCV33078, NCV33079

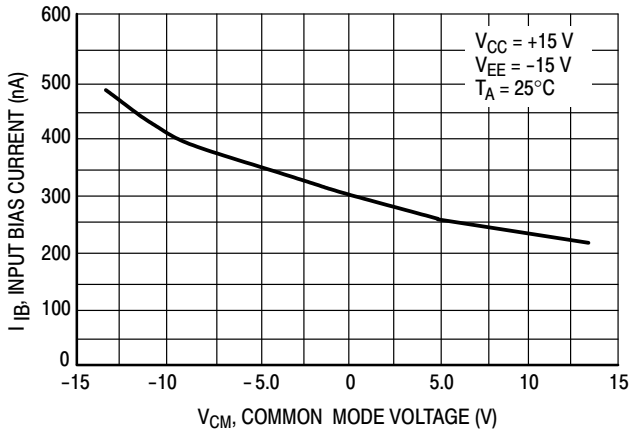

Figure 6. Input Bias Current versus Common Mode Voltage

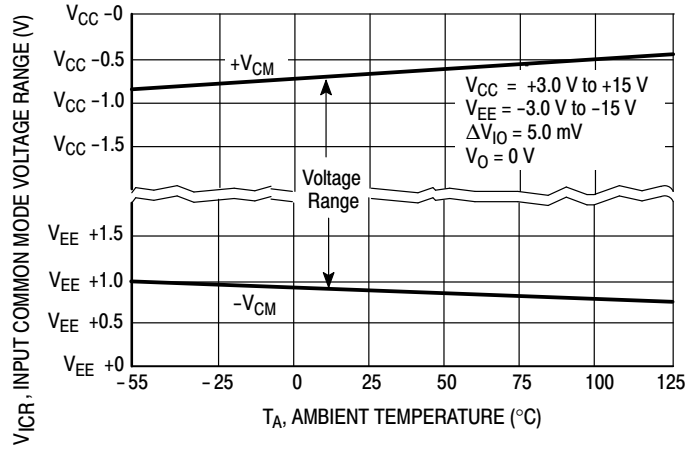

Figure 7. Input Common Mode Voltage Range versus Temperature

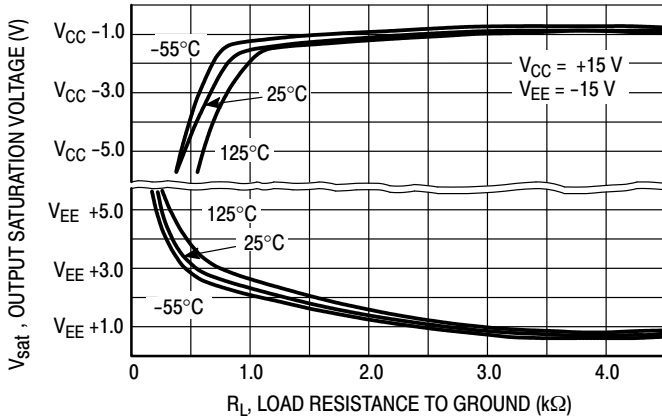

Figure 8. Output Saturation Voltage versus Load Resistance to Ground

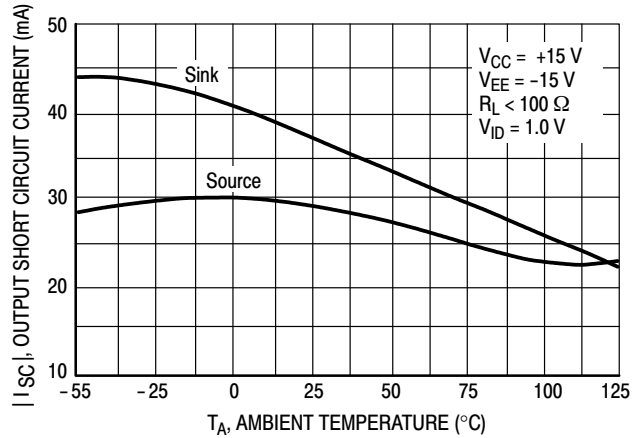

Figure 9. Output Short Circuit Current versus Temperature

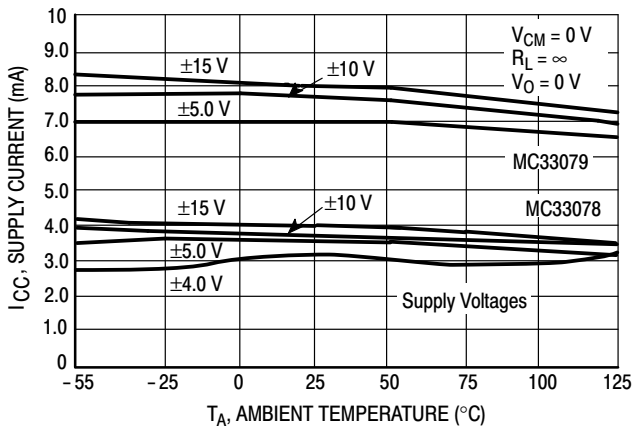

Figure 10. Supply Current versus Temperature

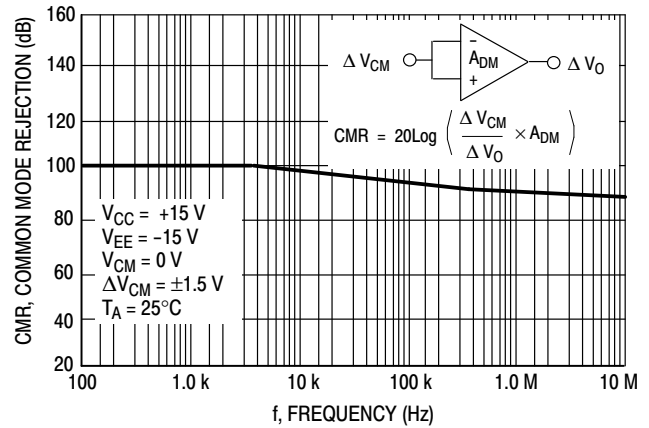

Figure 11. Common Mode Rejection versus Frequency

MC33078, MC33079, NCV33078, NCV33079

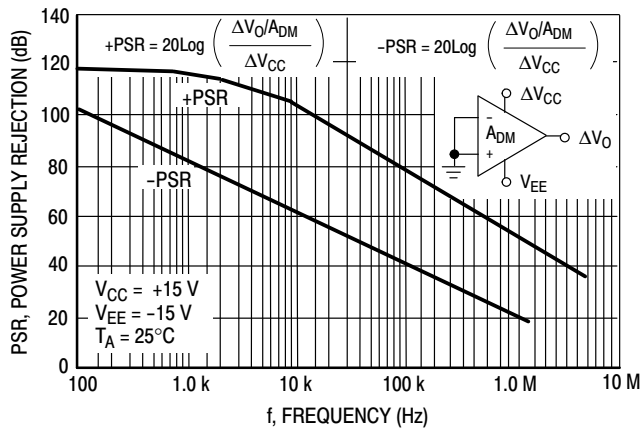

Figure 12. Power Supply Rejection versus Frequency

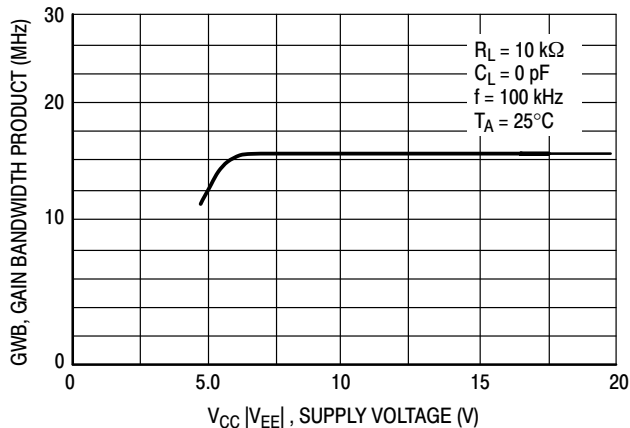

Figure 13. Gain Bandwidth Product versus Supply Voltage

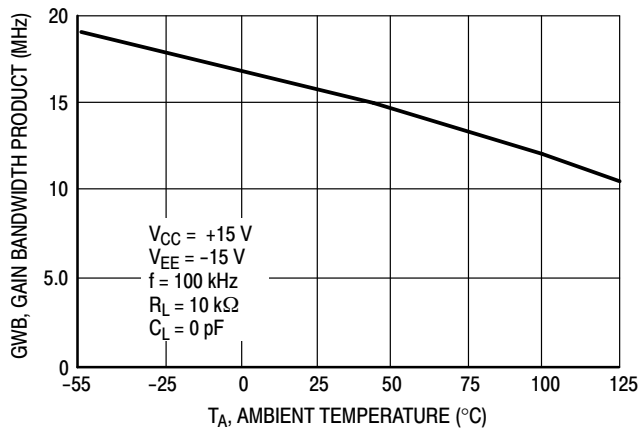

Figure 14. Gain Bandwidth Product versus Temperature

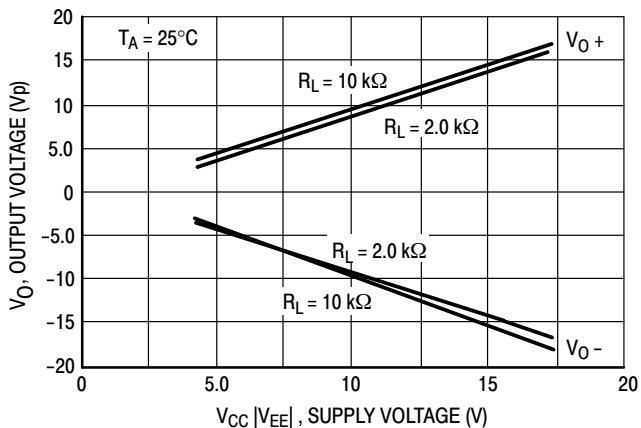

Figure 15. Maximum Output Voltage versus Supply Voltage

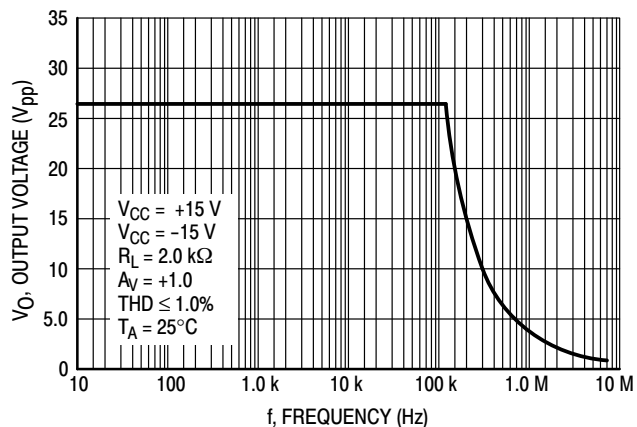

Figure 16. Output Voltage versus Frequency

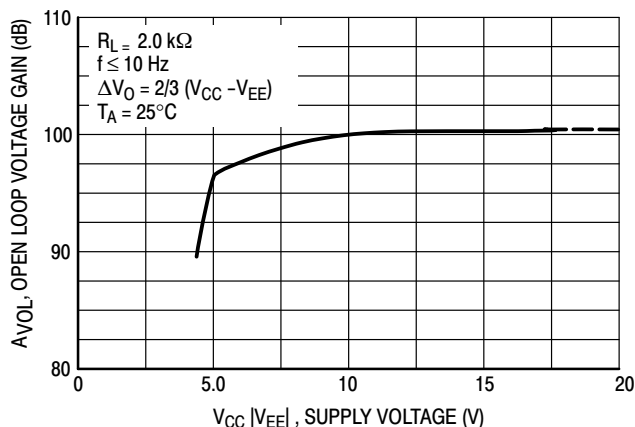

Figure 17. Open Loop Voltage Gain versus Supply Voltage

MC33078, MC33079, NCV33078, NCV33079

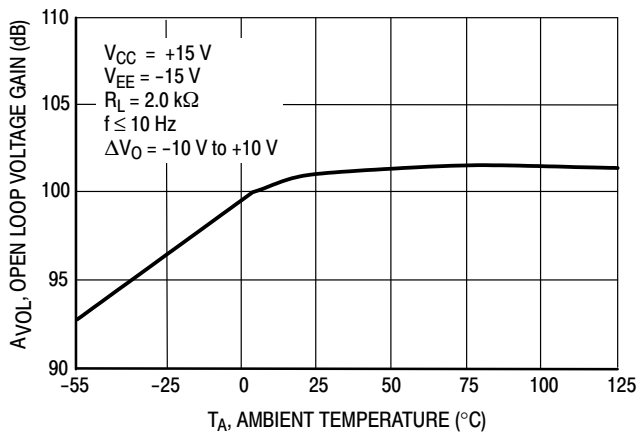

Figure 18. Open Loop Voltage Gain versus Temperature

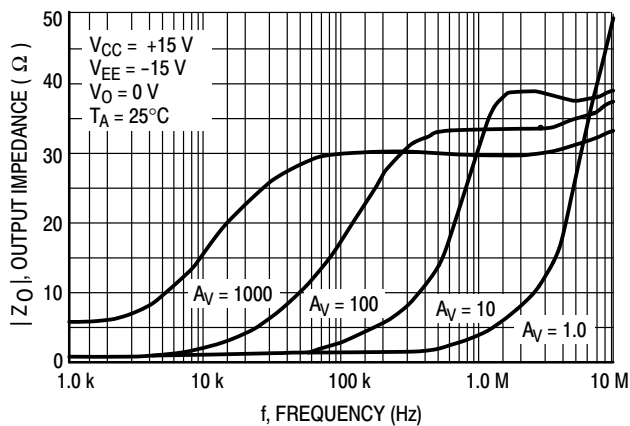

Figure 19. Output Impedance versus Frequency

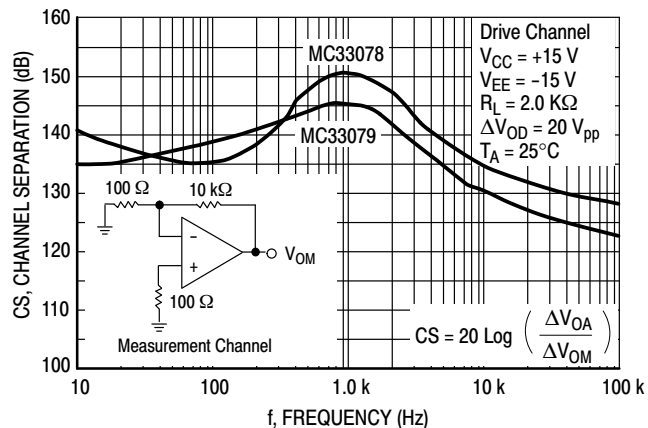

Figure 20. Channel Separation versus Frequency

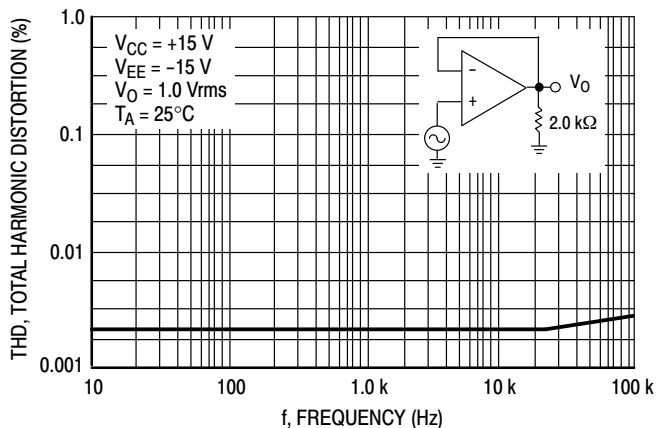

Figure 21. Total Harmonic Distortion versus Frequency

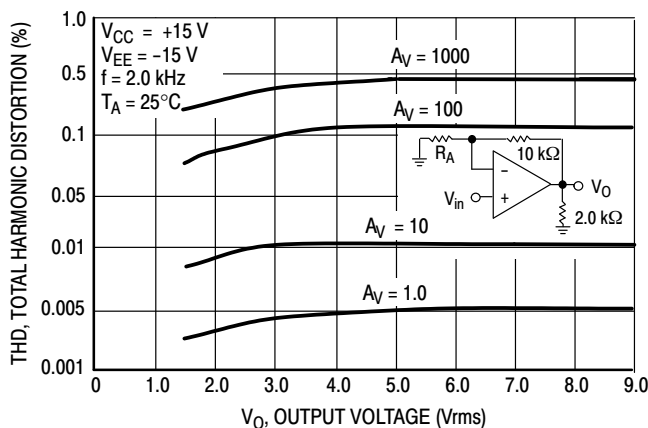

Figure 22. Total Harmonic Distortion versus Output Voltage

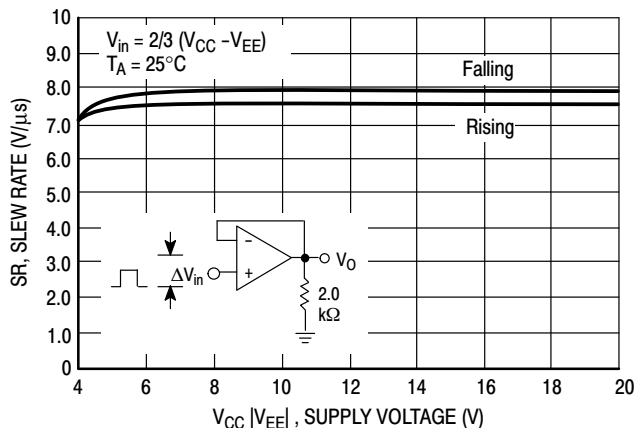

Figure 23. Slew Rate versus Supply Voltage



MC33078, MC33079, NCV33078, NCV33079

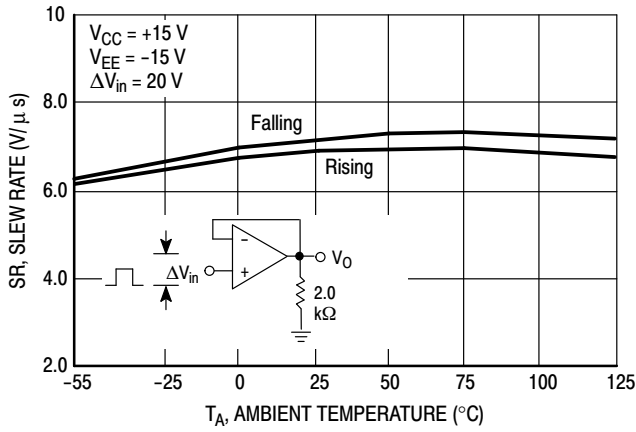

Figure 24. Slew Rate versus Temperature

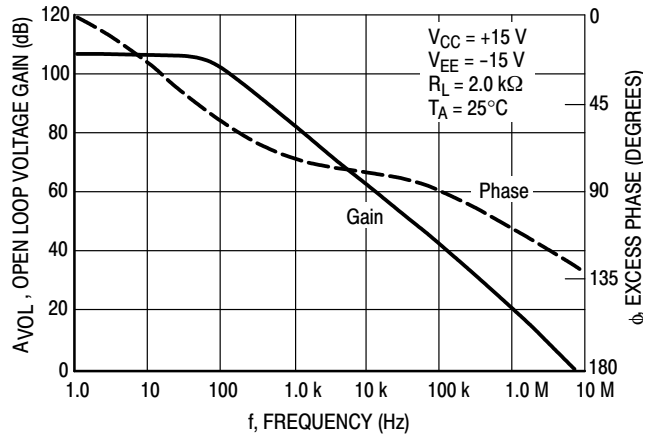

Figure 25. Voltage Gain and Phase versus Frequency

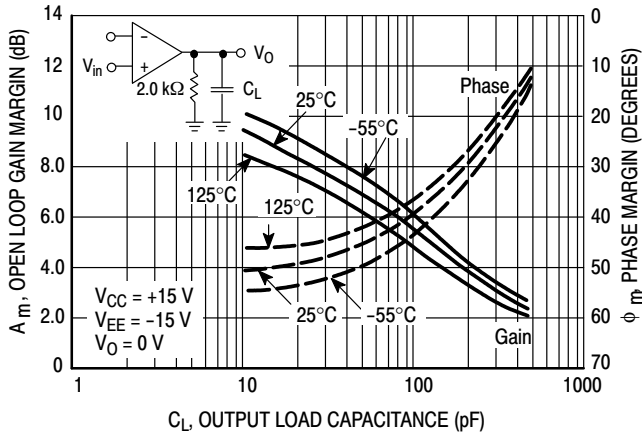

Figure 26. Open Loop Gain Margin and Phase Margin versus Load Capacitance

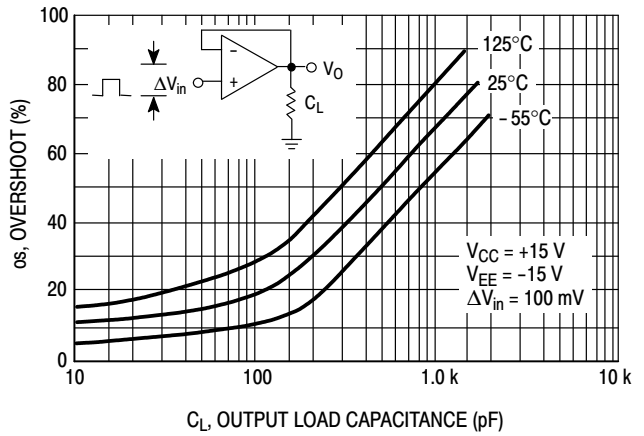

Figure 27. Overshoot versus Output Load Capacitance

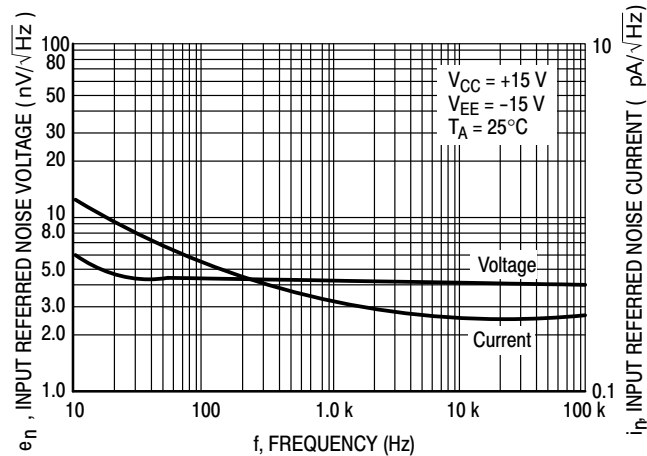

Figure 28. Input Referred Noise Voltage and Current versus Frequency

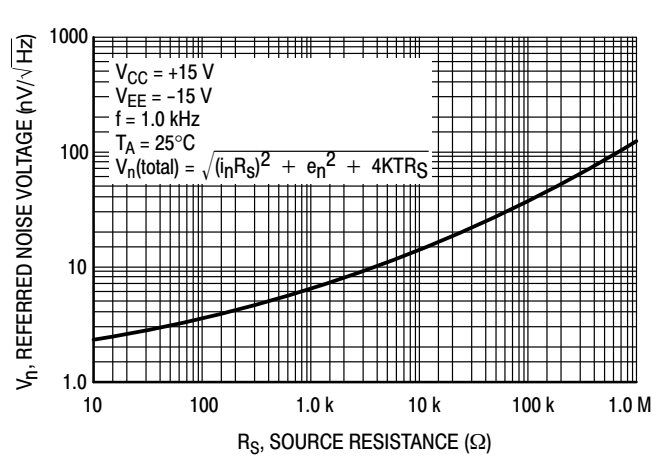

Figure 29. Total Input Referred Noise Voltage versus Source Resistance

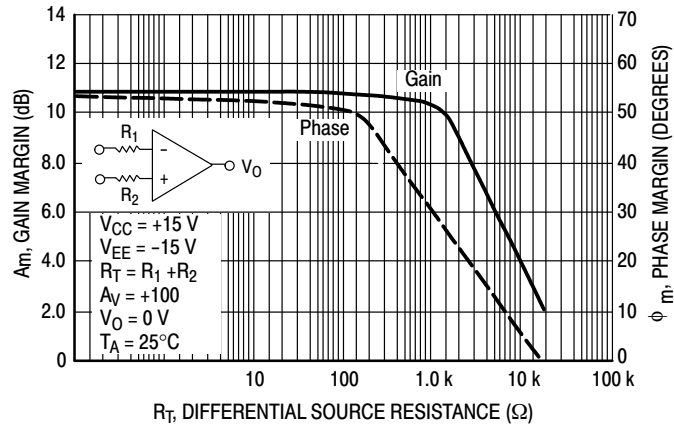

Figure 30. Phase Margin and Gain Margin versus Differential Source Resistance

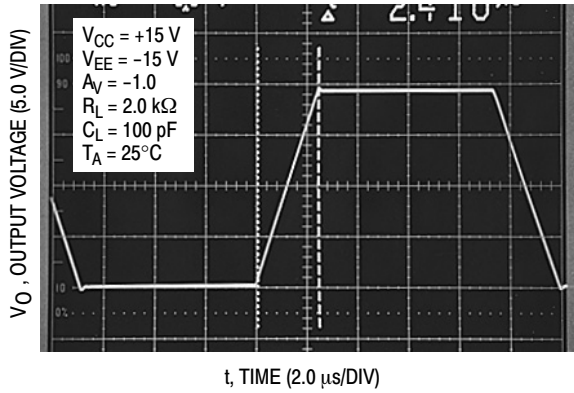

Figure 31. Inverting Amplifier Slew Rate

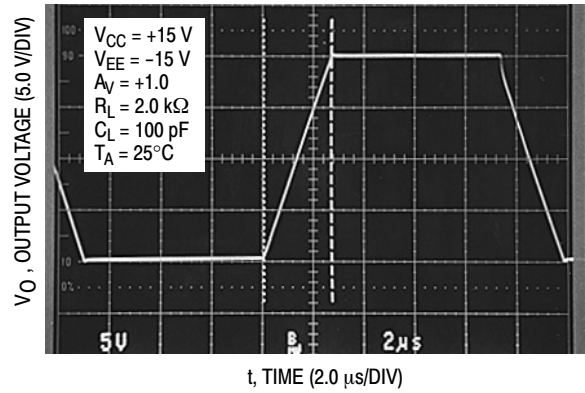

Figure 32. Non-inverting Amplifier Slew Rate

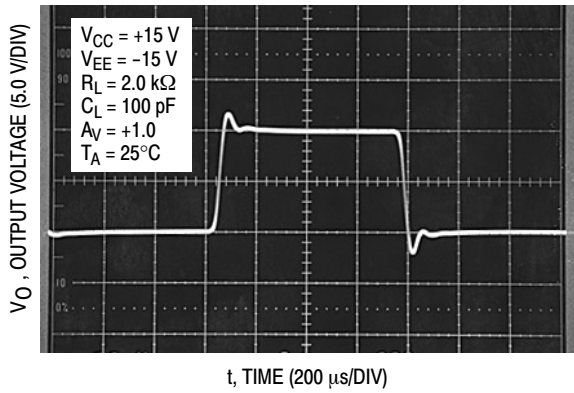

Figure 33. Non-inverting Amplifier Overshoot

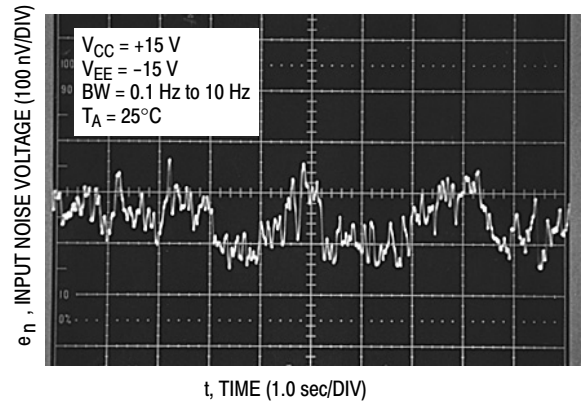
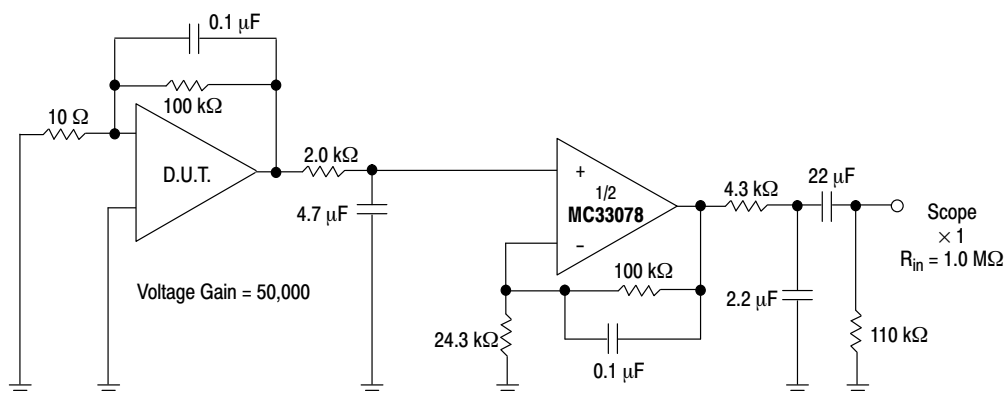

Figure 34. Low Frequency Noise Voltage versus Time

## MC33078, MC33079, NCV33078, NCV33079



Note: All capacitors are non-polarized.

**Figure 35. Voltage Noise Test Circuit  
(0.1 Hz to 10 Hz<sub>p-p</sub>)**

### ORDERING INFORMATION

Device	Package	Shipping <sup>†</sup>
MC33078DG	SOIC-8 (Pb-Free)	98 Units / Rail
MC33078DR2G		2500 / Tape & Reel
NCV33078DR2G*		
MC33078P	PDIP-8	50 Units / Rail
MC33078PG	PDIP-8 (Pb-Free)	
MC33079DG	SOIC-14 (Pb-Free)	55 Units / Rail
MC33079DR2G	SOIC-14 (Pb-Free)	2500 / Tape & Reel
NCV33079DR2G*		
MC33079P	PDIP-14	25 Units / Rail
MC33079PG	PDIP-14 (Pb-Free)	

<sup>†</sup>For information on tape and reel specifications, including part orientation and tape sizes, please refer to our Tape and Reel Packaging Specifications Brochure, BRD8011/D.

\*NCV devices are qualified for automotive use.

# MC33078, MC33079, NCV33078, NCV33079

## PACKAGE DIMENSIONS

PDIP-8  
N SUFFIX  
CASE 626-05  
ISSUE M

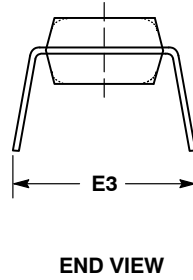
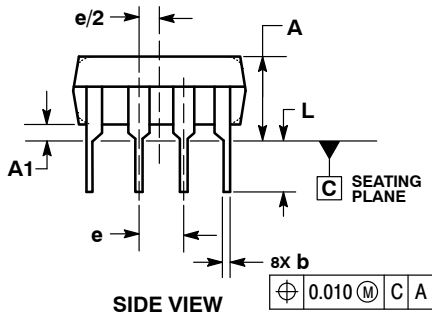
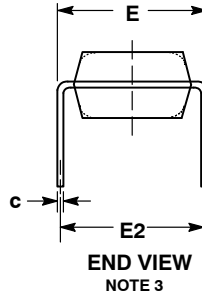
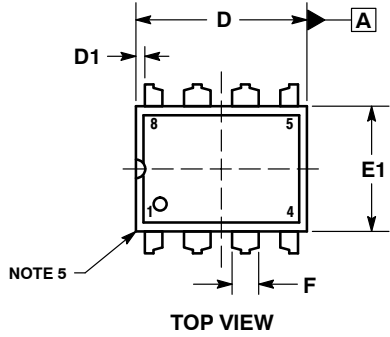

**NOTES:**

1. DIMENSIONING AND TOLERANCING PER ASME Y14.5M, 1994.
2. CONTROLLING DIMENSION: INCHES.
3. DIMENSION E IS MEASURED WITH THE LEADS RESTRAINED PARALLEL AT WIDTH E2.
4. DIMENSION E1 DOES NOT INCLUDE MOLD FLASH.
5. ROUNDED CORNERS OPTIONAL.

DIM	INCHES			MILLIMETERS		
	MIN	NOM	MAX	MIN	NOM	MAX
A	----	----	0.210	----	----	5.33
A1	0.015	----	----	0.38	----	----
b	0.014	0.018	0.022	0.35	0.46	0.56
C	0.008	0.010	0.014	0.20	0.25	0.36
D	0.355	0.365	0.400	9.02	9.27	10.02
D1	0.005	----	----	0.13	----	----
E	0.300	0.310	0.325	7.62	7.87	8.26
E1	0.240	0.250	0.280	6.10	6.35	7.11
E2	0.300 BSC			7.62 BSC		
E3	----	----	0.430	----	----	10.92
e	0.100 BSC			2.54 BSC		
L	0.115	0.130	0.150	2.92	3.30	3.81

PACKAGE DIMENSIONS

SOIC-8 NB  
CASE 751-07  
ISSUE AK

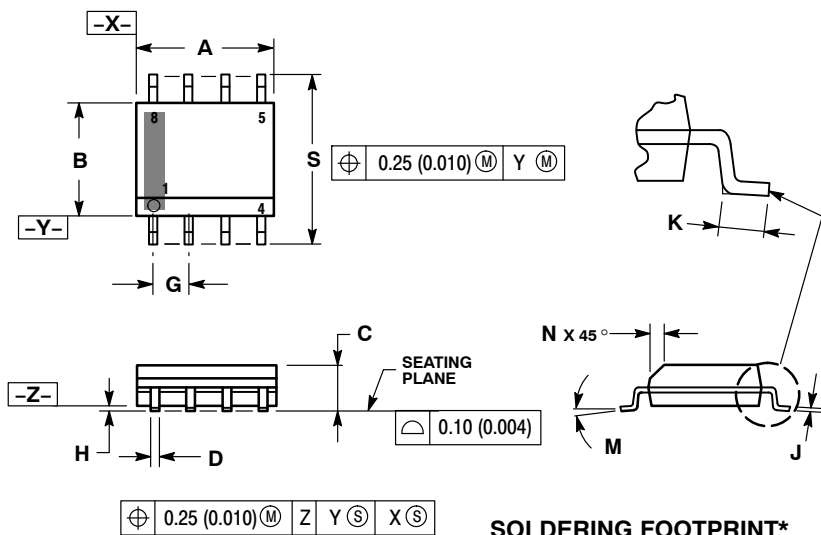

NOTES:

1. DIMENSIONING AND TOLERANCING PER ANSI Y14.5M, 1982.
2. CONTROLLING DIMENSION: MILLIMETER.
3. DIMENSION A AND B DO NOT INCLUDE MOLD PROTRUSION.
4. MAXIMUM MOLD PROTRUSION 0.15 (0.006) PER SIDE.
5. DIMENSION D DOES NOT INCLUDE DAMBAR PROTRUSION. ALLOWABLE DAMBAR PROTRUSION SHALL BE 0.127 (0.005) TOTAL IN EXCESS OF THE D DIMENSION AT MAXIMUM MATERIAL CONDITION.
6. 751-01 THRU 751-06 ARE OBSOLETE. NEW STANDARD IS 751-07.

DIM	MILLIMETERS		INCHES	
	MIN	MAX	MIN	MAX
A	4.80	5.00	0.189	0.197
B	3.80	4.00	0.150	0.157
C	1.35	1.75	0.053	0.069
D	0.33	0.51	0.013	0.020
G	1.27 BSC		0.050 BSC	
H	0.10	0.25	0.004	0.010
J	0.19	0.25	0.007	0.010
K	0.40	1.27	0.016	0.050
M	0°	8°	0°	8°
N	0.25	0.50	0.010	0.020
S	5.80	6.20	0.228	0.244

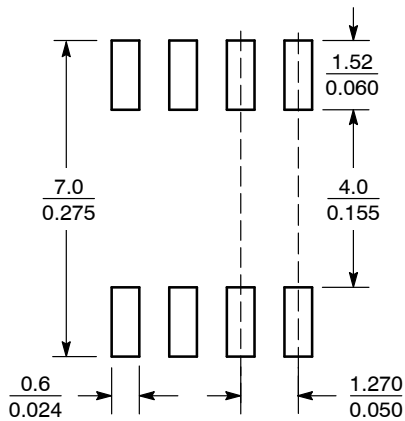

SCALE 6:1 (mm/inches)

\*For additional information on our Pb-Free strategy and soldering details, please download the ON Semiconductor Soldering and Mounting Techniques Reference Manual, SOLDERRM/D.

# MC33078, MC33079, NCV33078, NCV33079

## PACKAGE DIMENSIONS

**PDIP-14**  
CASE 646-06  
ISSUE P

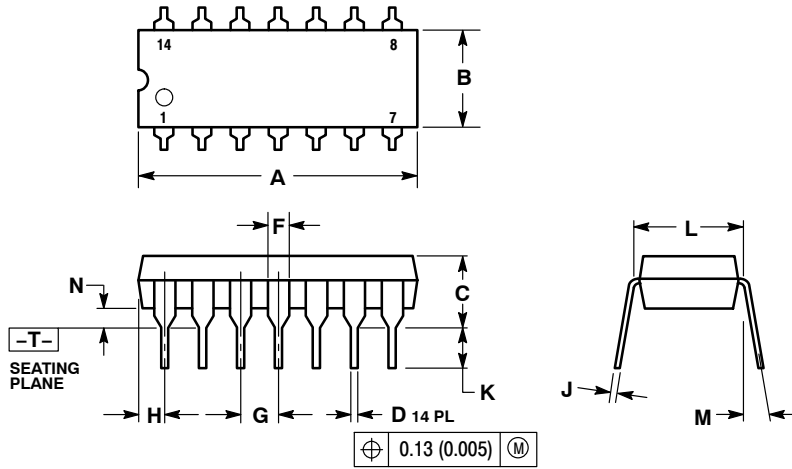

### NOTES:

1. DIMENSIONING AND TOLERANCING PER ANSI Y14.5M, 1982.
2. CONTROLLING DIMENSION: INCH.
3. DIMENSION L TO CENTER OF LEADS WHEN FORMED PARALLEL.
4. DIMENSION B DOES NOT INCLUDE MOLD FLASH.
5. ROUNDED CORNERS OPTIONAL.

DIM	INCHES		MILLIMETERS	
	MIN	MAX	MIN	MAX
A	0.715	0.770	18.16	19.56
B	0.240	0.260	6.10	6.60
C	0.145	0.185	3.69	4.69
D	0.015	0.021	0.38	0.53
F	0.040	0.070	1.02	1.78
G	0.100 BSC		2.54 BSC	
H	0.052	0.095	1.32	2.41
J	0.008	0.015	0.20	0.38
K	0.115	0.135	2.92	3.43
L	0.290	0.310	7.37	7.87
M	---	10°	---	10°
N	0.015	0.039	0.38	1.01

# MC33078, MC33079, NCV33078, NCV33079

## PACKAGE DIMENSIONS

SOIC-14 NB  
CASE 751A-03  
ISSUE K

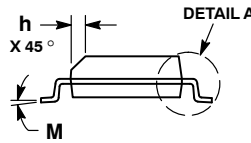
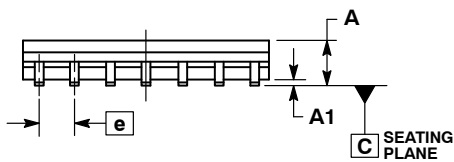
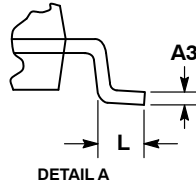
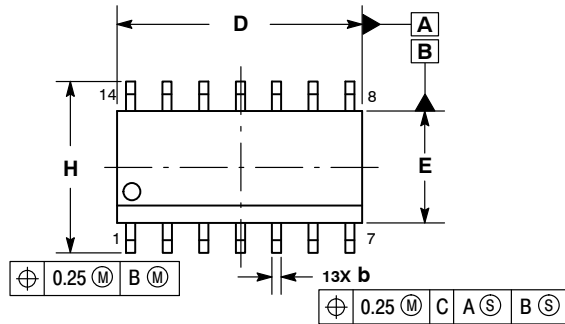

NOTES:

1. DIMENSIONING AND TOLERANCING PER ASME Y14.5M, 1994.
2. CONTROLLING DIMENSION: MILLIMETERS.
3. DIMENSION b DOES NOT INCLUDE DAMBAR PROTRUSION. ALLOWABLE PROTRUSION SHALL BE 0.13 TOTAL IN EXCESS OF AT MAXIMUM MATERIAL CONDITION.
4. DIMENSIONS D AND E DO NOT INCLUDE MOLD PROTRUSIONS.
5. MAXIMUM MOLD PROTRUSION 0.15 PER SIDE.

DIM	MILLIMETERS		INCHES	
	MIN	MAX	MIN	MAX
A	1.35	1.75	0.054	0.068
A1	0.10	0.25	0.004	0.010
A3	0.19	0.25	0.008	0.010
b	0.35	0.49	0.014	0.019
D	8.55	8.75	0.337	0.344
E	3.80	4.00	0.150	0.157
e	1.27 BSC		0.050 BSC	
H	5.80	6.20	0.228	0.244
h	0.25	0.50	0.010	0.019
L	0.40	1.25	0.016	0.049
M	0°	7°	0°	7°

### SOLDERING FOOTPRINT\*

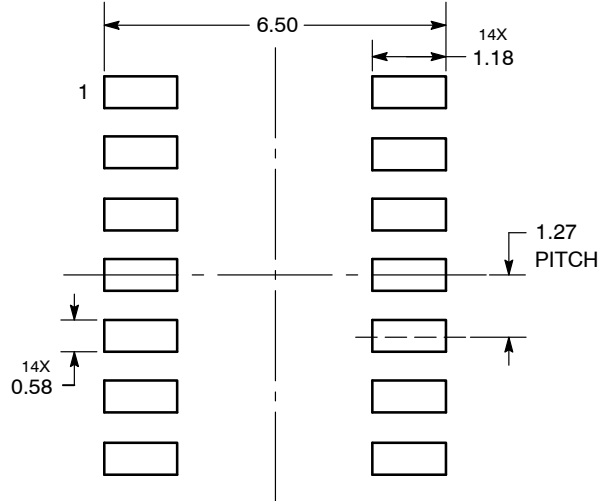

DIMENSIONS: MILLIMETERS

\*For additional information on our Pb-Free strategy and soldering details, please download the ON Semiconductor Soldering and Mounting Techniques Reference Manual, SOLDERRM/D.

ON Semiconductor and are registered trademarks of Semiconductor Components Industries, LLC (SCILLC). SCILLC reserves the right to make changes without further notice to any products herein. SCILLC makes no warranty, representation or guarantee regarding the suitability of its products for any particular purpose, nor does SCILLC assume any liability arising out of the application or use of any product or circuit, and specifically disclaims any and all liability, including without limitation special, consequential or incidental damages. "Typical" parameters which may be provided in SCILLC data sheets and/or specifications can and do vary in different applications and actual performance may vary over time. All operating parameters, including "Typicals" must be validated for each customer application by customer's technical experts. SCILLC does not convey any license under its patent rights nor the rights of others. SCILLC products are not designed, intended, or authorized for use as components in systems intended for surgical implant into the body, or other applications intended to support or sustain life, or for any other application in which the failure of the SCILLC product could create a situation where personal injury or death may occur. Should Buyer purchase or use SCILLC products for any such unintended or unauthorized application, Buyer shall indemnify and hold SCILLC and its officers, employees, subsidiaries, affiliates, and distributors harmless against all claims, costs, damages, and expenses, and reasonable attorney fees arising out of, directly or indirectly, any claim of personal injury or death associated with such unintended or unauthorized use, even if such claim alleges that SCILLC was negligent regarding the design or manufacture of the part. SCILLC is an Equal Opportunity/Affirmative Action Employer. This literature is subject to all applicable copyright laws and is not for resale in any manner.

### PUBLICATION ORDERING INFORMATION

**LITERATURE FULFILLMENT:**  
Literature Distribution Center for ON Semiconductor  
P.O. Box 5163, Denver, Colorado 80217 USA  
**Phone:** 303-675-2175 or 800-344-3860 Toll Free USA/Canada  
**Fax:** 303-675-2176 or 800-344-3867 Toll Free USA/Canada  
**Email:** orderlit@onsemi.com

**N. American Technical Support:** 800-282-9855 Toll Free USA/Canada  
**Europe, Middle East and Africa Technical Support:**  
Phone: 421 33 790 2910  
**Japan Customer Focus Center**  
Phone: 81-3-5817-1050

**ON Semiconductor Website:** [www.onsemi.com](http://www.onsemi.com)  
**Order Literature:** <http://www.onsemi.com/orderlit>

For additional information, please contact your local Sales Representative