



Chipsmall Limited consists of a professional team with an average of over 10 year of expertise in the distribution of electronic components. Based in Hongkong, we have already established firm and mutual-benefit business relationships with customers from,Europe,America and south Asia,supplying obsolete and hard-to-find components to meet their specific needs.

With the principle of "Quality Parts,Customers Priority,Honest Operation,and Considerate Service",our business mainly focus on the distribution of electronic components. Line cards we deal with include Microchip,ALPS,ROHM,Xilinx,Pulse,ON,Everlight and Freescale. Main products comprise IC,Modules,Potentiometer,IC Socket,Relay,Connector.Our parts cover such applications as commercial,industrial, and automotives areas.

We are looking forward to setting up business relationship with you and hope to provide you with the best service and solution. Let us make a better world for our industry!



Contact us

Tel: +86-755-8981 8866 Fax: +86-755-8427 6832

Email & Skype: info@chipsmall.com Web: www.chipsmall.com

Address: A1208, Overseas Decoration Building, #122 Zhenhua RD., Futian, Shenzhen, China



Technical Data

MC44BS373CA
Rev. 2.6, 6/2004

MC44BS373CA
Data Sheet

PLL-Tuned UHF and VHF
Audio/Video High-Integration
Modulator

MC44BS373CA

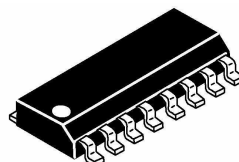

SO16NB Package QFN20 Package

Ordering Information

Device	Temp Range	Package
MC44BS373CAD,R2	-20 to +85°C	SO16NB
MC44BS373CAFC,R2	-20 to +85°C	QFN20 Lead Free
MC44BS373CAEF,R2	-20 to +85°C	SO16NB Lead Free

NOTE: For tape and reel, add R2 suffix.

Contents

- 1 Features 2
- 2 Comparing the MC44BS373CA to the MC44BC373/4C..... 2
- 3 Pin Descriptions..... 3
- 4 MC44BS373CA Functional Overview 5
- 5 Maximum Ratings 6
- 6 Thermal Ratings 6
- 7 Electrostatic Discharge 7
- 8 Electrical Characteristics 7
- 9 I2C Bit Mapping 8
- 10 I2C Programming 10
- 11 Modulator High-Frequency Characteristics 13
- 12 Video Characteristics..... 14
- 13 Audio Characteristics..... 16
- 14 Characterization Measurement Conditions 17
- 15 MC44BS373CA Modes of Operation 22
- 16 High Speed I2C Compatible Bus... 27
- 17 Pin Circuit Schematics..... 31
- 18 Application Diagrams..... 32
- 19 MC44BS373CA Evaluation Board Schematic and Layout 36
- 20 Packaging Instructions 41
- 21 Marking Instructions 42
- 22 Case Outlines 43
- 23 Document Revision History 48

The MC44BS373CA audio and video modulator is for use in VCRs, set-top boxes, and similar devices.

- Supports multiple standards
- TV output level 82 dBμV typical
- 5- and 3.3-V compatible I²C bus

Figure 1 shows the pin connections for both package options.

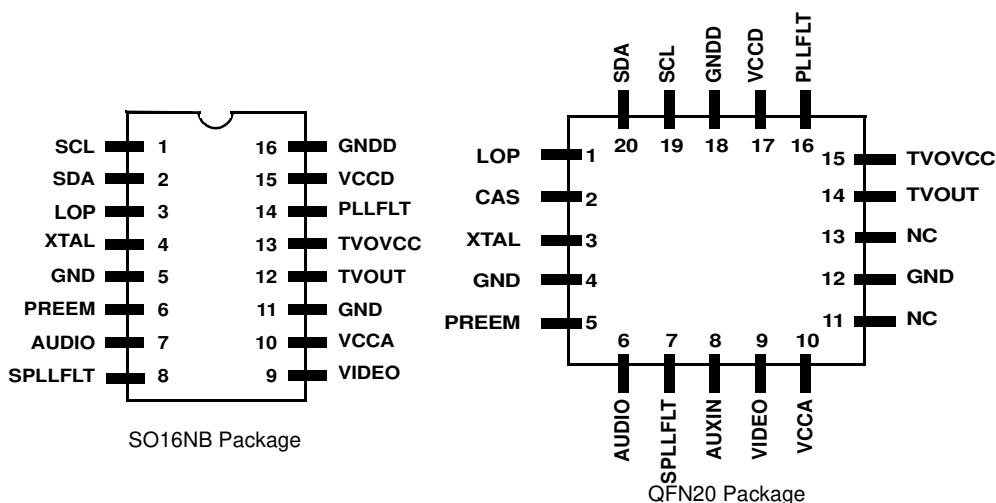

Figure 1. MC44BS373CA Pin Connections

1 Features

The MC44BS373CA is a multi-standard, PAL/SECAM/NTSC modulator.

The channel is set by an on-chip high-speed I²C-compatible bus receiver. A phase-locked loop (PLL) tunes the modulator over the full UHF range.

The modulator incorporates a sound subcarrier oscillator and uses a second PLL to derive 4.5-, 5.5-, 6.0-, and 6.5-MHz subcarrier frequencies. These frequencies are selectable by bus.

The modulation standard can be chosen using a control bit that selects between positive and negative modulation.

The picture-to-sound ratio may be adjusted using the bus. In addition, an on-chip video test pattern generator can be switched on with a 1-kHz audio test signal.

The MC44BS373CA also has the following features:

- Integrated on-chip programmable UHF oscillator
- No external varicaps diodes/inductor or tuned components
- Extremely low external component count
- Channel 21–69 UHF operation
- VHF range possible by internal dividers (30–450 MHz)
- Boosted TVOUT level (82 dB μ V typical)
- High-speed read and write I²C bus compatible (800 kHz)
- I²C address selectable by pin (four choices) using external resistor (available only in QFN20 package)
- I²C bus 5- and 3.3-V compatible
- Fixed video modulation depth (93% typical in system L and 82% typical in the other standards)
- Peak white clip disabled by bus
- Programmable picture/sound carrier ratio (12 and 16 dB)
- Integrated on-chip programmable sound subcarrier oscillator (4.5, 5.5, 6.0 and 6.5 MHz)—no external varicaps
- Programmable sound reference frequency (31.25 and 62.5 kHz)
- Direct RF sound modulator input (FM and AM modulator bypassed) for NICAM or stereo sound applications (available only in QFN20 package)
- On-chip video test pattern generator with sound test signal (1 kHz)
- Low-power programmable modulator standby mode
- Transient output inhibit during PLL lock-up at power-on
- Logical output port controlled by bus
- ESD protection, minimum 4 KV

2 Comparing the MC44BS373CA to the MC44BC373/4C

Compared to the MC44BC373/4C devices, the MC44BS373CA has the following improvements:

- Higher output level (82 versus 74.5 dB μ V)
- Higher video signal to noise (+3 dB)

- I²C bus 3.3-V compatible
- Lower power consumption in normal and standby modes (–2 mA)
- Can be powered down without holding down I²C lines
- TB1 bit no longer available (limited compatibility with MC44355 devices no longer available)
- New SREF bit to program sound reference frequency (31.25 and 62.5 kHz)
- Four different I²C addresses selectable by single pin with external resistor (available only in QFN20 package)
- Direct sound RF modulator (FM and AM sound modulators bypassed) for NICAM or stereo sound applications (available only in QFN20 package)
- Switch between two integrated VCOs controlled directly by frequency divider (at 700 MHz)
- Lower RF second harmonic spurious but higher third harmonic spurious. In applications it is easier to filter UHF third harmonics spurious than second harmonics, as these frequencies are always out of the UHF band. Unfortunately, the second harmonic can fall back into the same UHF band (for instance channel 21 second harmonic). For this reason, it is almost impossible to have a good rejection of low UHF second harmonic with an external low-pass filter. This is why the design has been optimized for maximum second harmonic rejection in spite of an increase in the third harmonic level.

3 Pin Descriptions

This section describes the pins of the MC44BS373CA. First the 16-pin package will be considered, then the 20-pin package.

3.1 SO16 Package Pin Descriptions

The pins of the 16-pin package are listed in Table 1, along with a description of each.

Table 1. SO16 Package Pin Descriptions

Pin	Name	Description	Pin	Name	Description
1	SCL	I ² C clock	9	VIDEO	Video input
2	SDA	I ² C data	10	VCCA	Main analog supply voltage
3	LOP	Logical output port controlled by I ² C bus	11	GND	Analog ground
4	XTAL	Crystal	12	TVOUT	TV output signal
5	GND	Ground	13	TVOVCC	TV output stage supply voltage
6	PREEM	Pre-emphasis capacitor	14	PLLFLT	RF PLL loop filter
7	AUDIO	Audio input	15	VCCD	Digital supply voltage
8	SPLLFLT	Sound PLL loop filter	16	GNDD	Digital ground

3.2 QFN20 Package Pin Descriptions

The pins of the 20-pin package are listed in Table 2, along with a description of each.

Table 2. QFN20 Package Pin Descriptions

Pin	Name	Description
1	LOP	Logical output port controlled by I ² C bus
2	CAS	Chip address selection (external pull-down resistor or open)
3	XTAL	Crystal
4	GND	Ground
5	PREEM	Pre-emphasis capacitor
6	AUDIO	Audio input
7	SPLLFLT	Sound PLL loop filter
8	AUXIN	Sound auxiliary input (sound FM and AM modulators bypassed)
9	VIDEO	Video input
10	VCCA	Main analog supply voltage
11	NC	Not connected
12	GND	Analog ground
13	NC	Not connected
14	TVOUT	TV output signal
15	TVOVCC	TV output stage supply voltage
16	PLLFLT	RF PLL loop filter
17	VCCD	Digital supply voltage
18	GNDD	Digital ground
19	SCL	I ² C clock
20	SDA	I ² C data

4 MC44BS373CA Functional Overview

Figure 2 shows a simplified block diagram of the MC44BS373CA.

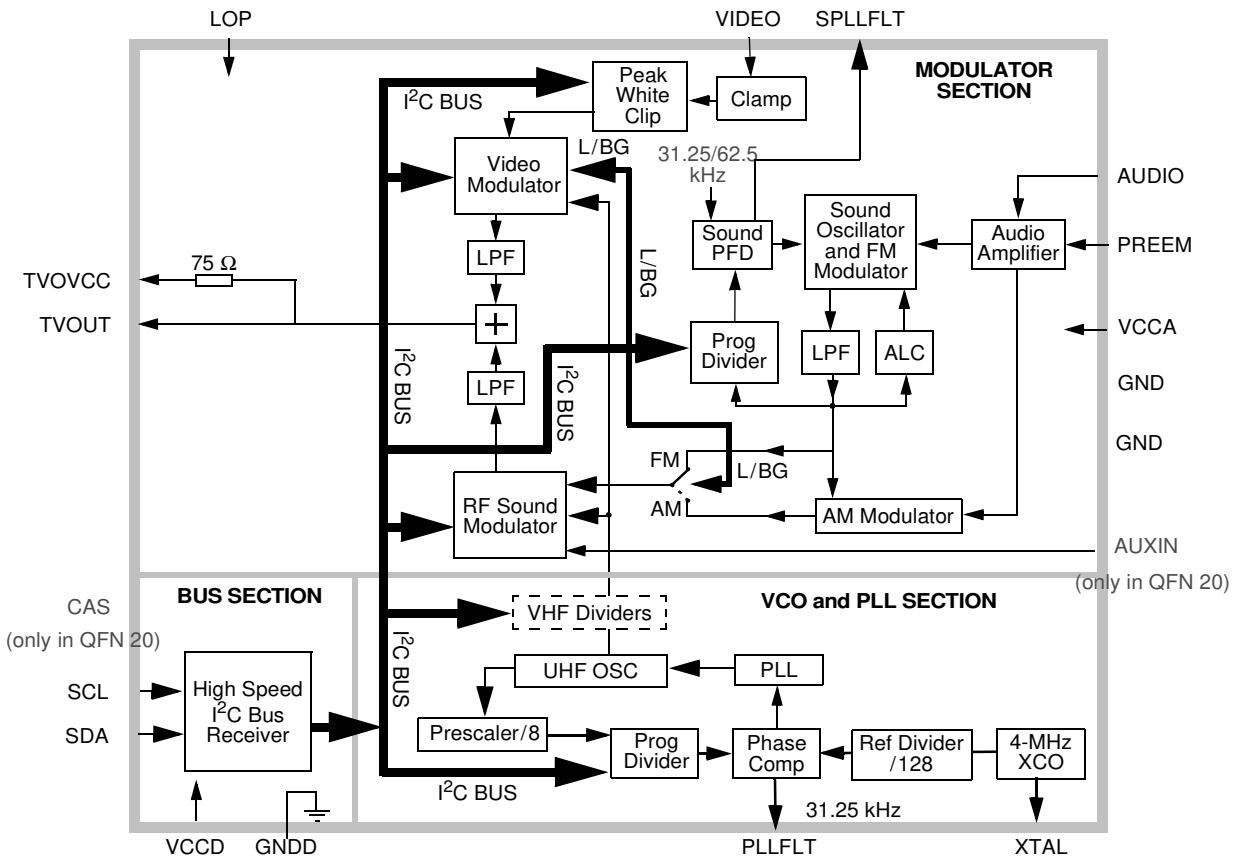

Figure 2. MC44BS373CA Simplified Block Diagram

The MC44BS373CA device has three main sections:

- A high-speed I²C-compatible bus section
- A PLL section to synthesize the UHF/VHF output channel frequency (from an integrated UHF oscillator, divided for VHF output)
- A modulator section, which accepts audio and video inputs, then uses them to modulate the UHF/VHF carrier

An on-chip video test pattern generator with an audio test signal is included.

The MC44BS373CA operates as a multi-standard modulator and can handle the following systems using the same external circuit components: B/G, I, D/K, L, M/N.

High-frequency BiCMOS technology allows integration of the UHF tank circuit and certain filtering functions.

5 Maximum Ratings

Table 3 lists the maximum ratings supported for operating conditions of the MC44BS373CA.

NOTE

This device contains protection circuitry to guard against damage due to high-static voltage or electric fields. However, precautions must be taken to avoid applications of any voltages higher than maximum rated voltage to this high-impedance circuit. For proper operation, input and output voltages should be constrained to the ranges indicated in the recommended operating conditions.

Table 3. Maximum Ratings¹

Symbol	Parameter	Value	Unit
V_{CC}	Supply voltage	6	V
T_{amin}	Minimum operating ambient temperature	-20	°C
T_{amax}	Maximum operating ambient temperature	+85	°C
T_{stgmin}	Minimum storage temperature	-65	°C
T_{stgmax}	Maximum storage temperature	150	°C
T_j	Junction temperature	150	°C

¹ Maximum ratings are those values beyond which damage to the device may occur. For functional operation, values should be restricted to the recommended operating conditions.

Moisture sensitivity level ratings for the different packages are given in Table 4.

Table 4. Moisture Sensitivity Level Ratings (MSL)

Package	Rating	Dry Pack Required
MC44BS373CAD,R2	1	No
MC44BS373CAFC,R2 lead free packages	3	Yes
MC44BS373CAEF,R2 lead free packages	3	Yes

6 Thermal Ratings

Table 5 lists the junction-to-ambient thermal resistance for both packages.

Table 5. Thermal Resistance from Junction to Ambient

Symbol	Package	Value	Unit
R_{thja}	SO16NB	102	°C/W
R_{thja}	QFN20	120	°C/W

7 Electrostatic Discharge

Electrostatic discharge (ESD) tests are carried out on all pins using MIL STD 883C method 3015-7. Results are shown in Table 6.

Table 6. Electrostatic Discharge Tests

Symbol	Parameter	Minimum	Unit
ESD	MM (machine model)	400	V
ESD	HBM (human body model)	4000	V

8 Electrical Characteristics

Each of the operating conditions listed in Table 7 is characterized as one of the following types:

- A—100% tested
- B—100% correlation tested
- C—Characterized on samples
- D—Design parameter

See Section 14, “Characterization Measurement Conditions,” for each C-type parameter.

8.1 Operating Conditions

Unless otherwise stated, $V_{CC} = 5.0\text{V}$, ambient temperature = 25°C , and video input is 1 V_{p-p} , with 10-step grey scale and RF output into $75\text{-}\Omega$ load.

NOTE

Specifications are only valid for envelope demodulation.

Table 7. Operating Conditions

Parameter	Condition	Minimum	Typical	Maximum	Unit	Type	Notes
Operating supply voltage range	—	4.5	5.0	5.5	V	B	
Total supply current ¹	—	42	50	58	mA	A	1
Total standby mode supply current ²	—	3	5	7	mA	A	2
Test pattern sync pulse width	—	3	4.7	6.5	μS	B	
Sound comparator charge pump current	During locking	7	10	12	μA	A	
	When locked	0.7	1	1.5			
RF comparator charge pump current	—	60	100	150	μA	A	
Crystal oscillator stability-negative resistance	—	1	—	—	$\text{K}\Omega$	D	
Logic output port saturation voltage at $I = 2\text{ mA}$	—	—	160	300	mV	A	
Logic output port leakage current	—	—	—	1	μA		

¹ All sections active

² OSC = SO = ATT = 1, bus section active. See Section 15.3, “Standby Mode.”

9 I²C Bit Mapping

Table 8. I²C Write-Mode Bit Mapping

Write Mode	Bit 7	Bit 6	Bit 5	Bit 4	Bit 3	Bit 2	Bit 1	Bit 0	ACK
Chip address	1	1	0	0	1	See Table 11.		0	ACK
C1—High-order bits	1	0	SO	LOP	PS	X3	X2	SYSL	ACK
C0—Low-order bits	PWC	OSC	ATT	SFD1	SFD0	SREF	X5	X4	ACK
FM—High-order bits	0	TPEN	N11	N10	N9	N8	N7	N6	ACK
FL—Low-order bits	N5	N4	N3	N2	N1	N0	X1	X0	ACK

Table 9. I²C Read-Mode Bit Mapping

Read Mode	Bit 7	Bit 6	Bit 5	Bit 4	Bit 3	Bit 2	Bit 1	Bit 0	ACK
Chip address	1	1	0	0	1	See Table 12.		1	ACK
R—Status byte	—	—	—	—	—	Y2	Y1	OOR	—

Table 10. I²C Bit Mapping Bit Descriptions

Name	Description
SO	Sound oscillator on/off 0 Sound oscillator on (normal mode) 1 Sound oscillation disabled (oscillator and PLL section bias turned off)
LOP	Logic output port 0 LOP pin is low voltage. 1 LOP pin is high impedance.
PS	Picture-to-sound carrier ratio 0 Picture-to-sound carrier ratio is 12 dB. 1 Picture-to-sound carrier ratio is 16 dB.
X0–X5	Test mode bits Note: All bits are 0 for normal operation. For further information, see Table 17 and Table 18.
SYSL	System L enable—Selects AM sound and positive video modulation 0 System B/G enabled, system L disabled (FM sound and negative video modulation) 1 System L enabled, system B/G disabled (AM sound and positive video modulation)
PWC	Peak white clip enable/disable 0 Peak white clip on (system B/G) 1 Peak white clip off (system L)
OSC	UHF oscillator on/off 0 Normal operation 1 UHF oscillator disabled (oscillator and PLL sections bias turned off)
ATT	Modulator output attenuated-sound and video modulators on/off 0 Normal operation 1 Modulator output attenuation (sound and video modulators sections bias turned off)

Table 10. I²C Bit Mapping Bit Descriptions (continued)

Name	Description															
SFD1 SFD0	Sound subcarrier frequency control bits <table border="1"> <thead> <tr> <th>SFD1</th> <th>SFD0</th> <th>Frequency</th> </tr> </thead> <tbody> <tr> <td>0</td> <td>0</td> <td>4.5</td> </tr> <tr> <td>0</td> <td>1</td> <td>5.5</td> </tr> <tr> <td>1</td> <td>0</td> <td>6.0</td> </tr> <tr> <td>1</td> <td>1</td> <td>6.5</td> </tr> </tbody> </table>	SFD1	SFD0	Frequency	0	0	4.5	0	1	5.5	1	0	6.0	1	1	6.5
SFD1	SFD0	Frequency														
0	0	4.5														
0	1	5.5														
1	0	6.0														
1	1	6.5														
SREF	Sound PLL reference frequency 0 Sound reference frequency = 31.25 kHz 1 Sound reference frequency = 62.5 kHz															
TPEN	Test pattern enable-picture and sound 0 Test pattern signal off (normal operation) 1 Test pattern signal on (picture and sound)															
N0–N11	UHF frequency programming bits, in steps of 250 kHz See Section 15.7, “UHF PLL Section,” for more information.															
Y2	RF oscillator operating range information 0 High VCO is active. 1 Low VCO is active.															
Y1	RF oscillator operating range information 0 VCO out of range, frequency too low. Only valid if OOR=1 1 VCO out of range, frequency too high. Only valid if OOR=1															
OOR	RF oscillator out-of-frequency range information 0 Normal operation, VCO in range 1 VCO out of range															

Table 11 and Table 12 show how to select the I²C address.

NOTE

The I²C address is also selectable via the CAS pin. See Section 16, “High Speed I²C Compatible Bus,” for more information.

Table 11. I²C Address Selection, Write Mode

SFD1	SFD0	Address Selected	
		Binary	Hex
0	0	1100_1000	0xC8
1	0	1100_1010	0xCA
0	1	1100_1100	0xCC
1	1	1100_1110	0xCE

Table 12. I²C Address Selection, Read Mode

SFD1	SFD0	Address Selected	
		Binary	Hex
0	0	1100_1001	0xC9
1	0	1100_1011	0xCB
0	1	1100_1101	0xCD
1	1	1100_1111	0xCF

10 I²C Programming

The following tables list, by category, the bits used to program various parameters of the MC44BS373CA.

10.1 Sound Settings

Table 13 lists the sound settings used.

Table 13. Sound Settings

Bit	Value		Setting
Sound Subcarrier Frequency (MHz)			
SFD1 SFD0	SFD1	SFD0	
	0	0	4.5
	0	1	5.5
	1	0	6.0
	1	1	6.5
Picture-to-Sound Ratio (dB)			
PS	0		12
	1		16
Sound Oscillator			
SO	0		Sound oscillator on (normal mode)
	1		Sound oscillation disabled (oscillator and PLL section bias turned off)

Table 14 lists the video settings used.

Table 14. Video Settings

Bit	Value		Setting
System L/BG Selection			
SYSL	0		System B/G enabled, system L disabled (FM sound and negative video modulation)
	1		System L enabled, system B/G disabled (AM sound and positive video modulation)
Peak White Clip			
PWC	0		Peak white clip on (system B/G)
	1		Peak white clip off (system L)
Test Pattern Signal			
TPEN	0		Test pattern signal off (normal operation)
	1		Test pattern signal on (picture and sound)

Table 15 lists the UHF settings used.

Table 15. UHF Settings

Bit	Value	Setting
UHF Oscillator		
OSC	0	Normal operation
	1	UHF oscillator disabled (oscillator and PLL sections bias turned off)
Modulator Output Attenuation		
ATT	0	Normal operation
	1	Modulator output attenuation (sound and video modulators sections bias turned off)

Table 16 lists the other settings used.

Table 16. Other Settings

Bit	Value	Setting
Sound PLL		
SREF	0	Sound reference frequency = 31.25 kHz.
	1	Sound reference frequency = 62.5 kHz.
Logic Output Port		
LOP	0	LOP pin is low voltage.
	1	LOP pin is high impedance.
Standby Mode		
OSC SO ATT	1, 1, 1	Puts the MC44BS373CA into standby mode. See Section 15.3, "Standby Mode," for more information.

Table 17 lists settings of fields X2, X1, and X0, used to set the device into test mode 1 and to control the VHF range.

NOTE

Test modes 1 and 2 are intended for manufacturing test purposes only and cannot be used for normal applications, except for VHF range (states 1.b to 1.e).

Table 17. Write Mode—Test Mode 1 and VHF Range

X2	X1	X0	State	Description
0	0	0	1.a	Normal operation
0	0	1	1.b	RF frequency divided for low-frequency testing or VHF range: RF/2
0	1	0	1.c	RF/4
0	1	1	1.d	RF/8
1	0	0	1.e	RF/16

Table 17. Write Mode—Test Mode 1 and VHF Range (continued)

X2	X1	X0	State	Description
1	0	1	1.f	DC drive applied to modulators—Non-inverted video at TVOUT
1	1	0	1.g	DC drive applied to modulators—Inverted video at TVOUT
1	1	1	1.h	Transient output inhibit disabled (that is, speed-up mode) During this speed-up test mode, ATT = 0 forces sound current source to 1 μ A, while ATT = 1 forces it to 10 μ A.

Table 18 lists settings of fields X5, X4, and X3, used to set the device into test mode 2.

Table 18. Write Mode—Test Mode 2

X5	X4	X3	State	Description
0	0	0	2.a	Normal operation
0	0	1	2.b	Test pattern generator DC verification (test pattern DC test mode available)
0	1	0	2.c	Program divider test (UHF program divider on PLLFILT pin and sound program divider on SPLLFIL pin)
0	1	1	2.d	Reference divider test (UHF reference divider on PLLFILT pin)
1	0	0	2.e	UHF phase comparison, upper source on PLLFILT pin Sound phase comparison 10- μ A upper source on SPLLFIL (only valid during transient output inhibit)
1	0	1	2.f	UHF phase comparison, lower source on PLLFILT pin Sound phase comparison 10- μ A lower source on SPLLFIL (only valid during transient output inhibit)
1	1	0	2.g	Sound phase comparison 1- μ A upper source on SPLLFIL (not valid during transient output inhibit)
1	1	1	2.h	Sound phase comparison 1- μ A lower source on SPLLFIL (not valid during transient output inhibit)

Table 19 lists settings of fields Y2, Y1, and OOR, used to set the device into READ mode and to determine RF oscillator out-of-frequency range information.

Table 19. Read Mode

Bit	Value	Setting
OOR	0	Normal operation, VCO in range
	1	VCO out of range
Y1	0	VCO out of range, frequency too low. Only valid if OOR=1
	1	VCO out of range, frequency too high. Only valid if OOR=1
Y2	0	High VCO is active.
	1	Low VCO is active.

11 Modulator High-Frequency Characteristics

Each of the characteristics listed in Table 20 is classified as one of the following types:

- A—100% tested
- B—100% correlation tested
- C—Characterized on samples
- D—Design parameter

See Section 14, “Characterization Measurement Conditions,” for each C-type parameter.

Unless otherwise stated, $V_{CC} = 5.0\text{V}$, ambient temperature = 25°C , and video input is 1 V_{p-p}, with 10-step grey scale and RF output into 75-Ω load.

NOTE

Specifications only valid for envelope demodulation.

Table 20. High-Frequency Characteristics

Parameter	Test Conditions	Min	Typ	Max	Unit	Type	Notes
TVOUT output level	Output signal from modulator section	79	82	85	dBμV	B	1, 2
UHF oscillator frequency	—	460	—	880	MHz	A	
VHF range	From UHF oscillator internally divided	45	—	460	MHz	B	
TVOUT output attenuation	During transient output inhibit, or when ATT bit is set to 1	65	75	—	dBc	B	1, 2
Sound subcarrier harmonics (F _p + n × F _s)	Reference picture carrier	50	63	—	dBc	C	1
Second harmonic of chroma subcarrier	Using red EBU bar	45	70	—	dBc	C	1
Chroma/sound intermodulation: F _p + (F _{snd} – F _{chr})	Using red EBU bar	65	82	—	dBc	C	1
Fo (picture carrier) harmonics	2nd harmonic: CH21	—	38	50	dBμV	C	1,3
	3rd harmonic: CH21	—	58	70			
	Other channels	—					
Out-of-band (picture carrier) spurious	1/2 × Fo – 1/4 × Fo – 3/2 × Fo – 3/4 × Fo From 40 MHz to 1 GHz.	—	—	10	dBμV	C	1
In-band spurious (Fo at 5 MHz)	No video sound modulation.	65	75	—	dBc	C	1

Notes:

1. See Section 14, “Characterization Measurement Conditions.”
2. See Figure 3.
3. Picture carrier harmonics are highly dependent on PCB layout and decoupling capacitors.

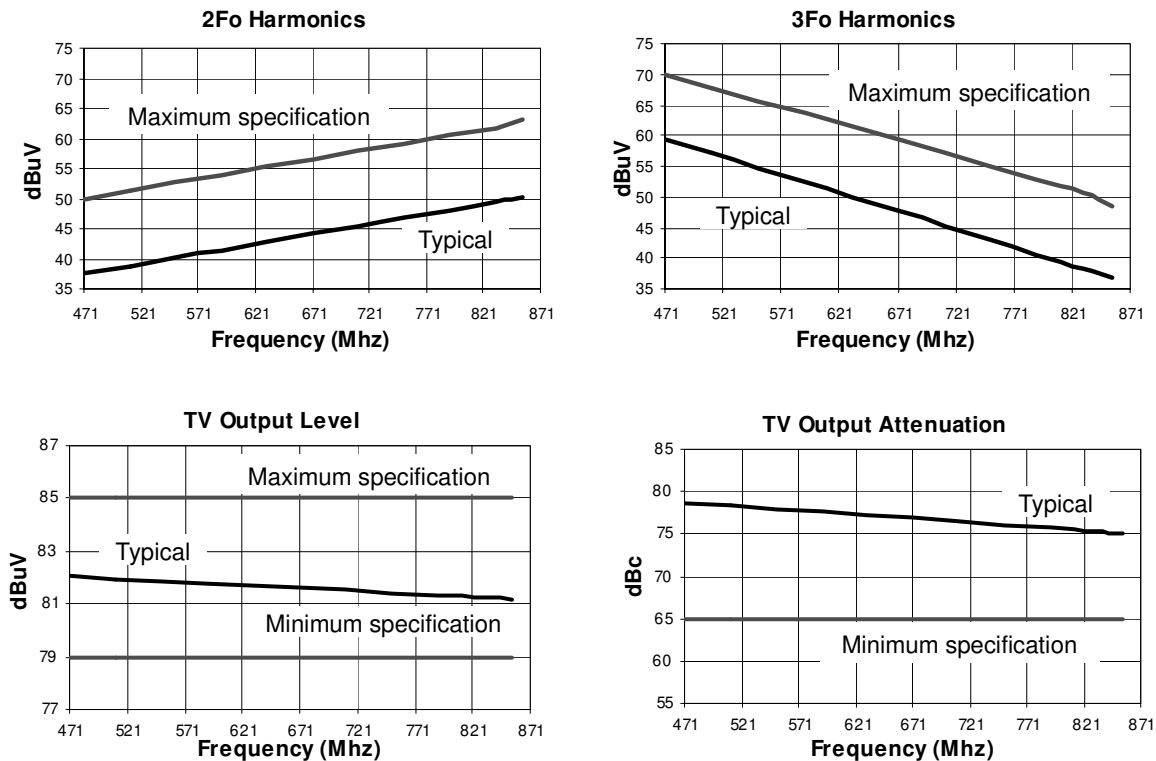

Figure 3. Typical High-Frequency Performance

12 Video Characteristics

Each of the characteristics listed in Table 21 is classified as one of the following types:

- A—100% tested
- B—100% correlation tested
- C—Characterized on samples
- D—Design parameter

See Section 14, “Characterization Measurement Conditions,” for each C-type parameter.

Unless otherwise stated, $V_{CC} = 5.0V$, ambient temperature = $25^{\circ}C$, and video input is 1 Vp-p, with 10-step grey scale and RF output into 75- Ω load.

NOTE

Specifications are only valid for envelope demodulation.

Table 21. Video Performance Characteristics

Parameter	Test Conditions	Minimum	Typical	Maximum	Unit	Type	Notes
Video bandwidth	Reference 0 dB at 100 kHz, measured at 5 MHz.	-1.5	-0.8	—	dB	C	1
Video input level	75- Ω load	—	—	1.5	V_{CVBS}	D	
Video input current		—	0.2	1	μA	A	

Table 21. Video Performance Characteristics (continued)

Parameter	Test Conditions	Minimum	Typical	Maximum	Unit	Type	Notes
Video input impedance		500	—	—	K Ω	A	
Peak white clip	Video modulation depth for video = 1.4 V _{CVBS}	90.5	94	97.5	%	B	
Video S/N	No sound modulation, 100% white video						
	Using CCIR Rec.567 weighting filter	53	56	—	dB	C	1, 2
	Unweighted	48	53	—		C	1
Differential phase	CCIR test line 330, worst case from first 4 steps out of 5	-5	—	5	deg	C	1
Differential gain	CCIR test line 330, worst case from first 4 steps out of 5	-5	—	5	%	C	1
Luma/Sync ratio	Input ratio 7.0:3.0	6.8/3.2	7.0/3.0	7.2/2.8	—	B	
PAL video modulation depth (SYSL = 0)		76	82	88	%	B	1, 2
SECAM video modulation depth (SYSL = 1)		87	93	99	%	B	1, 2

Notes:

1. See Section 14, "Characterization Measurement Conditions."
2. See Figure 4.

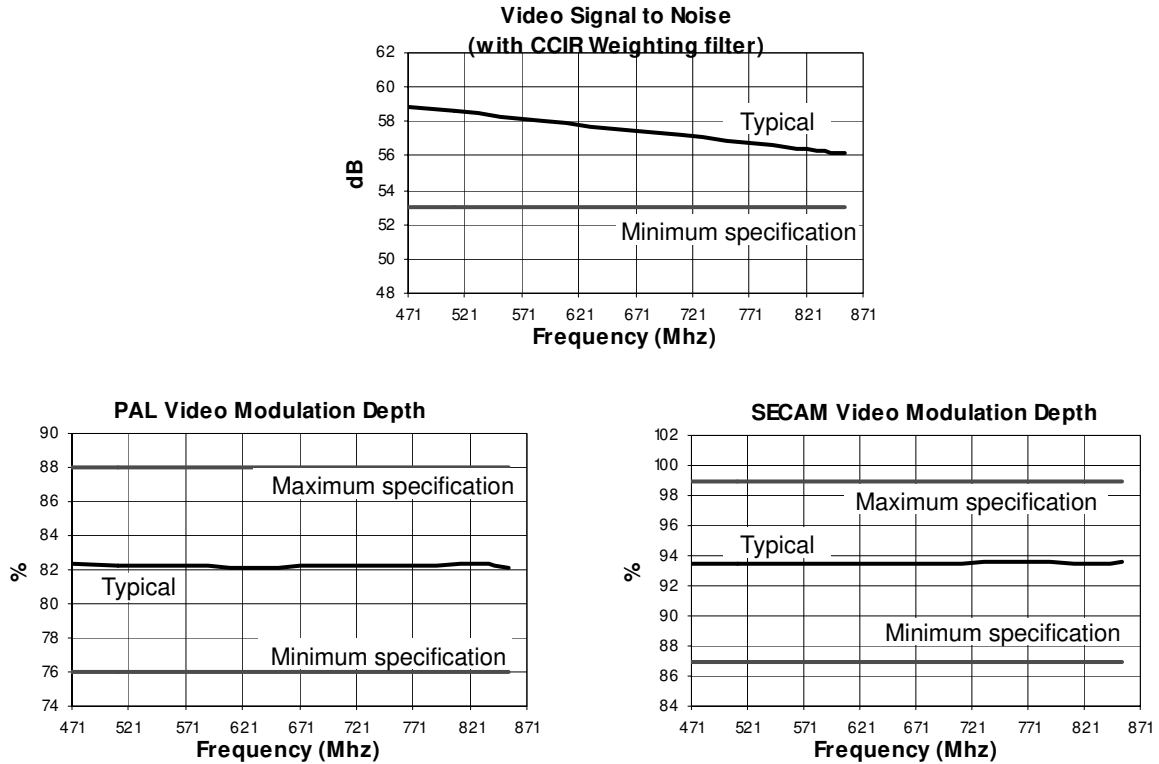

Figure 4. Typical Video Performance

13 Audio Characteristics

Each of the characteristics listed in Table 22 is classified as one of the following types:

- A—100% tested
- B—100% correlation tested
- C—Characterized on samples
- D—Design parameter

See Section 14, “Characterization Measurement Conditions,” for each C-type parameter.

Unless otherwise stated, $V_{CC} = 5.0\text{V}$, ambient temperature = 25°C , and video input is 1 Vp-p, with 10-step grey scale and RF output into $75\text{-}\Omega$ load.

NOTE

Specifications are only valid for envelope demodulation.

Table 22. Audio Performance Characteristics ¹

Parameter	Test Conditions	Minimum	Typical	Maximum	Unit	Type
Picture-to-sound ratio	PS bit set to 1	13	16	19	dB	B
	PS bit set to 0	9	12	15		
Audio modulation depth	Using specific pre-emphasis circuit, audio input level = 205 mVrms, audio frequency = 1 kHz					
	AM modulation: SECAM $F_s=6.5\text{MHz}$	76	80	84	%	B
	FM modulation: $F_s=5.5, 6, \text{ or } 6.5\text{ MHz}$ 100% modulation = $\pm 50\text{ kHz}$ FM deviation	76	80	84	%	B
	FM modulation: NTSC $F_s=4.5\text{MHz}$ 100% modulation = $\pm 25\text{ kHz}$ FM deviation	76	80	84	%	B
Audio input resistance		45	53	61	K Ω	A
Audio frequency response	Reference 0dB at 1kHz using specified pre-emphasis circuit, measured from 50 Hz to 15 kHz (depends on loop filter components)	-2.0	—	+2.0	dB	C
Audio distortion FM (THD only)	At 1 kHz, 100% modulation ($\pm 50\text{ kHz}$) No video	—	0.2	0.8	%	C
Audio distortion AM (THD only)	At 1 kHz, 100% modulation No video	—	1.5	2.5	%	D
Audio S/N with sync buzz FM	Ref 1 kHz, 50% modulation ($\pm 25\text{ kHz}$) EBU color bars video signal, using CCIR 468-2 weighting filter	50	54	—	dB	C
Audio S/N with sync buzz AM	Reference 1 kHz, 85% modulation Video input EBU color bar 75% Audio BW 40Hz–15kHz, using CCIR 468-2 weighting filter	45	50	—	dB	D

¹ See Section 14, “Characterization Measurement Conditions.”

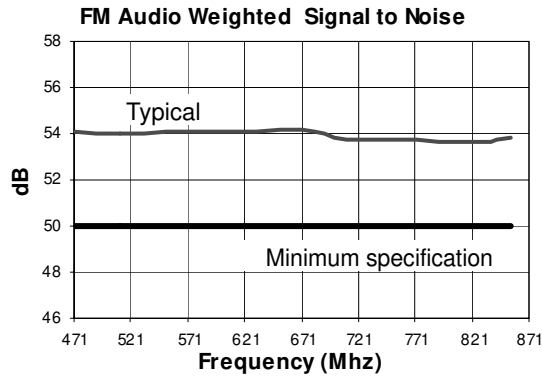

Figure 5. Typical Audio Performance

14 Characterization Measurement Conditions

Table 23 shows the MC44BS373CA default configuration unless otherwise specified.

Table 23. Device Default Configuration

Device Feature	Default Setting
Peak white clip	Enabled
UHF oscillator	On
Sound and video modulators	On
Sound subcarrier frequency	5.5 MHz
Sound oscillator	On
Sound PLL reference frequency	31.25 kHz
Logic output port	Low
Picture-to-sound carrier ratio	12 dB
System L	Disabled
Test pattern	Disabled
All test mode bits	Zero
Frequency	From channel 21 to 69

RF inputs/output into 75-Ω load using a 75- to 50-Ω transformation. Video input 1 V_{p-p}. Audio pre-emphasis circuit enabled.

Table 24. Measurement Conditions

Device and Signal Set-Up	Measurement Set-Up
TVOUT Output Level	
Video: 10-step grey scale No audio	Measured picture carrier in dB _μ V with the HP8596E spectrum analyzer using a 75- to 50-Ω transformation, all cable losses and transformation pads having been calibrated. Measurement used as a reference for other tests: TVout_Ref

Table 24. Measurement Conditions (continued)

Device and Signal Set-Up	Measurement Set-Up
TVOUT Output Attenuation	
ATT bit = 1 No video signal No audio signal	Measure in dBc picture carrier at ATT = 1 with reference to picture carrier at ATT = 0
Sound Subcarrier Harmonics	
Video: 10-step grey scale No audio signal	Measure in dBc second and third sound harmonics levels in reference to picture carrier (TVout_Ref). 
Second Harmonics of Chroma Subcarrier	
No audio Video: a 700-mVp-p, 100-kHz sinusoidal signal is inserted on the black level of active video area. 	Measure in dBc, in reference to picture carrier (TVout_Ref), second harmonic of chroma at channel frequency plus two times chroma frequency, resulting in the following spectrum. 
Chroma/Sound Intermodulation	
No audio signal Video: a 700-mVp-p, 100-kHz sinusoidal signal is inserted on the black level of active video area. This is generated using a Rohde & Schwarz video generator SAF and inserting the required frequency from an RF signal generator. 	Measure in dBc, in reference to picture carrier (TVout_Ref), intermodulation product at channel frequency plus the sound carrier frequency (+5.5 MHz) minus the chroma frequency (-4.43 MHz), resulting in the following spectrum (Intermodulation product is at the channel frequency +1.07 MHz): 

Table 24. Measurement Conditions (continued)

Device and Signal Set-Up	Measurement Set-Up
Picture Carrier Harmonics	
No video signal No audio signal	Measure in dBc, in reference to picture carrier (TVout_Ref), second and third harmonic of channel frequency, resulting in the following spectrum <div style="text-align: center;"> <p>Picture carrier 2nd harmonic 3rd harmonic F_o $2F_o$ $3F_o$</p> </div>
Out-of-Band Spurious	
No video signal No audio signal	Measure in dB μ V spurious levels at 0.25, 0.5, 0.75 and 1.5 times channel frequency, resulting in the following spectrum (measure from 40 MHz to 1 GHz): <div style="text-align: center;"> <p>Spurious Picture carrier $F_o/4$ $F_o/2$ $F_o \times 3/4$ F_o $F_o \times 3/2$</p> </div>
In-Band Spurious	
No video signal No audio signal	Measure in dBc, in reference to picture carrier (TVout_Ref), spurious levels falling into video bandwidth starting from ± 100 kHz from the picture carrier up to ± 5 MHz.
Video Bandwidth	
No audio Video: 600-mVp-p sinusoidal signal inserted on the black level of active video area	The video signal is demodulated on the spectrum analyzer, and the peak level of the 100-kHz signal is measured as a reference. The frequency is then swept from 100 kHz to 5 MHz, and then the difference in dB from the 100-kHz reference level is measured.
Weighted Video Signal to Noise	
Video: 100% white video signal, 1 Vp-p. No audio signal This is measured using a Rohde & Schwarz AMFS UHF demodulator in B/G (using a CCIR Rec. 567 weighting network), 100-kHz to 5-MHz band with sound trap and envelope detection, and a Rohde & Schwarz UAF video analyzer.	The video analyzer measures the ratio between the amplitude of the active area of the video signal (700 mV) and the noise level in Vrms on a video black level which is shown below. Video S/N is calculated as $20 \times \log(700/N)$ in dB. <div style="text-align: center;"> <p>N noise level in Vrms</p> </div>

Table 24. Measurement Conditions (continued)

Device and Signal Set-Up	Measurement Set-Up
Unweighted Video Signal to Noise	
Same as above with CCIR filter disabled	Same as above
Video Differential Phase	
<p>Video: 5-step grey scale, 1 Vp-p No audio signal This is measured using a Rohde & Schwarz AMFS UHF demodulator in B/G (using a CCIR Rec. 567 weighting network), 100-kHz to 5-MHz band with sound trap and envelope detection, and a Rohde & Schwarz UAF video analyzer.</p>	<p>On line CCIR 330, the video analyzer DP measure consists of calculating the difference of the chroma phase at the black level and the different chroma subcarrier phase angles at each step of the grey scale. The largest positive or negative difference indicates the distortion.</p> $\text{Diff Phase} = \frac{\text{Largest positive or negative difference}}{\text{Phase at position 0}} \times 100\%$ <p>The video analyzer method takes the worst step from the first 4 steps.</p>
Video Differential Gain	
<p>Video: 5-step grey scale, 1 Vp-p No audio signal This is measured using a Rohde & Schwarz AMFS UHF demodulator in B/G (using a CCIR Rec. 567 weighting network), 100-kHz to 5-MHz band with sound trap and envelope detection, and a Rohde & Schwarz UAF video analyzer.</p>	<p>On line CCIR 330 shown below, the video analyzer DG measure consists of calculating the difference of the chroma amplitude at the black level and the different amplitudes at each step of the grey scale. The largest positive or negative difference indicates the distortion.</p> <div style="text-align: center;">  <p>5-Step Grey Scale with Chroma Subcarrier Superimposed (Not to Scale), Line CCIR 330</p> </div> $\text{Diff Gain} = \frac{\text{Largest positive or negative difference}}{\text{Amplitude at position zero}} \times 100\%$ <p>The video analyzer method takes the worst step from the first 4 steps.</p>
Video Modulation Depth	
<p>No audio signal Video: 10-step grey scale</p>	<p>This is measured using an HP8596E spectrum analyzer with a TV trigger option, allowing demodulation and triggering on any specified TV line. The analyzer is centred on the maximum peak of the video signal and reduced to 0 Hz span in linear mode to demodulate the video carrier</p> <div style="text-align: center;">  <p>TV Line Demodulated by Spectrum Analyzer—BG Standard</p> </div> <p>The modulation depth is calculated as $(A - B) / A \times 100$ in percent. Same measurement method for L standard, with inverted video.</p>

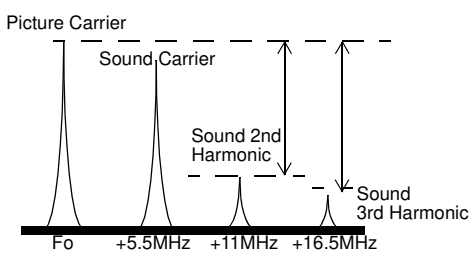
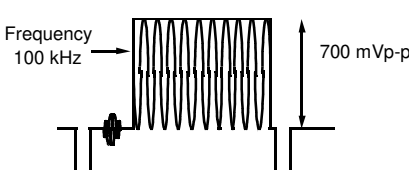
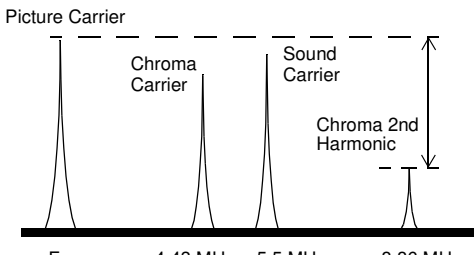
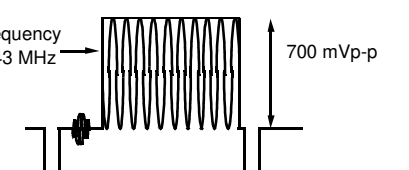
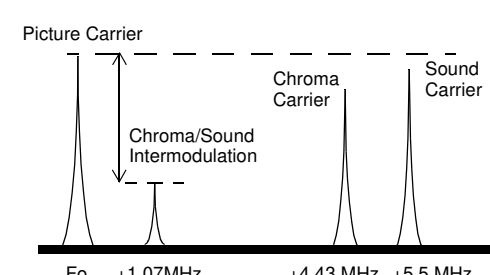
Table 24. Measurement Conditions (continued)

Device and Signal Set-Up	Measurement Set-Up
Picture-to-Sound Ratio	
No video signal No audio signal PS bit set to 0 and 1	Measure in dBc sound carrier in reference to picture carrier (TVout_Ref) for PS bit = 0 (PS = 12 dB typical) and for PS bit = 1 (PS = 16 dB), <div style="text-align: center;">  </div>
Audio Modulation Depth—FM Modulation	
Video black level Audio signal: 1 kHz, 205 mVrms. This is measured using a Rohde & Schwarz AMFS demodulator in B/G and an HP8903A audio analyzer at 1 kHz.	The audio signal, 205 mV at 1 kHz, is supplied by the audio analyzer, and the FM demodulated signal deviation is indicated on the demodulator in kHz peak. This value is then converted into percentage of FM deviation, based on specified standards.
Audio Frequency Response	
Video black level Audio signal: 50 Hz to 15 kHz, 100 mVrms This is measured using a Rohde & Schwarz AMFS demodulator in B/G and an HP8903A audio analyzer.	The audio signal, 1 kHz 100 mVrms, is supplied by the audio analyzer, and demodulated by the demodulator. The audio analyzer measures the AC amplitude of this demodulated audio signal. This value is taken as a reference (0 dB). The audio signal is then swept from 50 Hz to 15 kHz and demodulated. AC amplitude is measured in dB relative to the 1-kHz reference. Audio pre-emphasis and de-emphasis circuits are engaged and all audio analyzer filters are switched off.
Audio Distortion FM	
Audio: 1 kHz, adjustable level Video black level This is measured using a Rohde & Schwarz AMFS UHF demodulator in B/G and an HP8903A audio analyzer at 1 kHz. The output level of the audio analyzer is varied to obtain a deviation of 50 kHz indicated on the demodulator.	The input arms detector of the audio analyzer converts the AC level of the combined signal + noise + distortion to DC. It then removes the fundamental signal (1 kHz) after having measured the frequency. The output rms detector converts the residual noise + distortion to DC. The DC voltmeter measures both DC signals and calculates the ratio of the two signals as a percentage. $ADist = (Distortion + Noise)/(Distortion + Noise + Signal)$
Audio Signal to Noise	
Audio: 1 kHz, adjustable level Video: EBU color bars This is measured using a Rohde & Schwarz AMFS demodulator in B/G and an HP8903A audio analyzer at 1 kHz. The output level of the audio analyzer is varied to obtain a modulation deviation of 25 kHz indicated on the AMFS demodulator.	The audio analyzer alternately turns on and off its internal audio source to make a measure of the audio signal plus noise and then another measure of only the noise. The measurement is made using the internal CCIR 468-2 filter of the audio analyzer together with the internal 30±2-kHz (60 dB/decade) low-pass filters. The AMFS demodulator uses a quasi-parallel demodulation as is the case in a normal TV set. In this mode the Nyquist filter is bypassed and the video carrier is used without added delay to effectuate intercarrier conversion. In this mode the phase noise information fully cancels out and the true S/N can be measured. $ASN(dB) = 20 \times \log(Signal + Noise)/(Noise)$

15 MC44BS373CA Modes of Operation

15.1 Power-On Settings

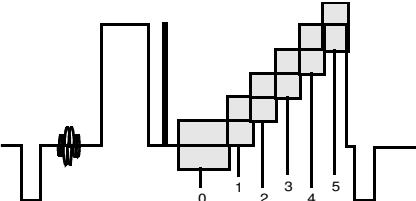
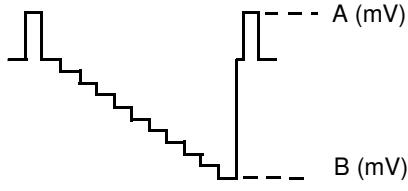
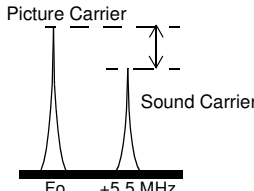
At power on, the MC44BS373CA is configured as shown in Table 25 below.

Table 25. Power-On Settings

WRITE MODE	Bit 7	Bit 6	Bit 5	Bit 4	Bit 3	Bit 2	Bit 1	Bit 0	ACK
C1-High order bits	1	0	0	0	0	0	0	0	ACK
C0-Low order bits	0	0	0	0	1	0	0	0	ACK
FM-High order bits	0	0	N11	N10	N9	N8	N7	N6	ACK
FL-Low order bits	N5	N4	N3	N2	N1	N0	0	0	ACK

Note:

N0 to N11 are set to have UHF oscillator on channel E36 (591.25 MHz). (See Section 15.7, "UHF PLL Section," for more information.) Peak white clip is on. Sound frequency is 5.5 MHz. Sound reference frequency is 31.25 kHz. Logic output port is low voltage. Picture-to-sound ratio is 12 dB.

15.2 Power Supply

The three device V_{CC} pins (pins 10, 13 and 15 for SO16 package, pins 10, 15 and 17 for QFN20 package) must be applied at the same time to ensure all internal blocks are correctly biased. Do not bias any other pin before V_{CC} is applied to the MC44BS373CA.

When all V_{CC} s are switched to 0 V, the SDA and SCL pins are high impedance.

15.3 Standby Mode

During standby mode, the modulator is switched to low power consumption. That is, the sound oscillator, UHF oscillator, and the video and sound modulator sections' bias are internally turned off. The I²C bus section remains active.

The MC44BS373CA can be set to standby mode with a combination of 3 bits: OSC = 1, SO = 1, and ATT = 1.

15.4 System L or B/G Selection

The SYSL pin can be used to switch the device between system L and system B/G, as summarized in Table 26.

Table 26. System L or B/G Selection

Function	B/G (SYSL = 0)	L (SYSL = 1)
Video modulation polarity	Negative	Positive
Video modulation depth (% typical) ¹	82	93
Sound modulation	FM	AM

¹ See Section 12, "Video Characteristics."

15.5 Transient Output Inhibit

To minimize the risk of interference to other channels while the UHF PLL is acquiring a lock on the desired frequency, the sound and video modulators are turned off during a timeout period for the following cases:

- Power-on from zero (that is, all V_{CC} switched from 0 to 5 V)
- UHF oscillator power-on from off state (that is, OSC bit switched from 1 to 0)

There is a timeout of 263 ms until the output is enabled. This lets the UHF PLL settle to its programmed frequency. During the 263-ms timeout, the sound PLL current source is set to 10 μ A typical to speed up the locking time. After the timeout, the current source is switched to 1 μ A. Use care when selecting loop filter components to ensure the loop transient does not exceed this delay.

For test purposes, it is possible to disable the 263-ms delay using test mode 1, state 1.h. (This is called speed-up mode.) Table 17 provides settings pertaining to test mode 1.

15.6 UHF Oscillator—VHF range

The UHF oscillator is fully integrated and does not require any external components.

For low-frequency testing or VHF range operation (test mode 1, states 1.b to 1.e) the UHF oscillator can be internally divided by 2, 4, 8, or 16.

15.7 UHF PLL Section

The reference divider is a fixed divide-by-128, resulting in a reference frequency of 31.25 kHz with a 4.0-MHz crystal.

The prescaler is a fixed divide-by-8 and is permanently engaged.

The programmable divider division ratio is controlled by the state of control bits N0 to N11.

The divider ratio N for a desired frequency F (in MHz) is given by:

$$N = \frac{F}{8} \times \frac{128}{4}$$

with:

$$N = 2048 \times N11 + 1024 \times N10 + \dots + 4 \times N2 + 4 \times N1 + N0$$

NOTE

Programming a division ratio of $N = 0$ is not allowed.

15.8 Logic Output Port (LOP)

The LOP pin controls any logic function. The primary applications for LOP are to control an external attenuator or an external switch between the antenna input and TV output. A typical attenuator application with PIN diode is shown in Figure 6. The LOP pin switches the PIN attenuator depending on the signal strength of the antenna input. This reduces the risk of intermodulation in certain areas. The LOP can also be used as an off position bypass switch or for other logic functions in the application.

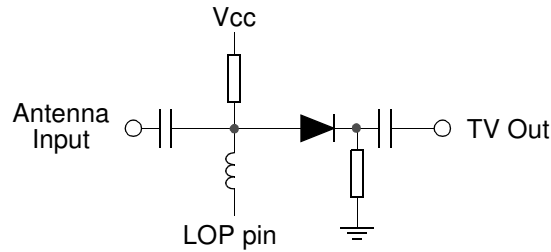

Figure 6. Typical Attenuator Application with Pin Diode

15.9 Video Section—Peak White Clip

The MC44BS373CA requires the following for proper video functionality:

- A composite video input with negative going sync pulses
- A nominal level of 1 V_{p-p}

This signal is AC-coupled to the video input where the sync tip level is clamped.

The video signal is then passed to a peak white clip (PWC) circuit. The PWC circuit function soft-clips the top of the video waveform, if the sync tip amplitude to peak white clip goes too high. This avoids carrier over-modulation by the video. Clipping can be disabled by software.

15.10 Test Pattern Generator

The I²C generates a simple test pattern, which can be switched under bus control to permit a TV receiver to easily tune to the modulator output. The pattern consists of two white vertical bars on a black background and a 976-Hz audio test signal.

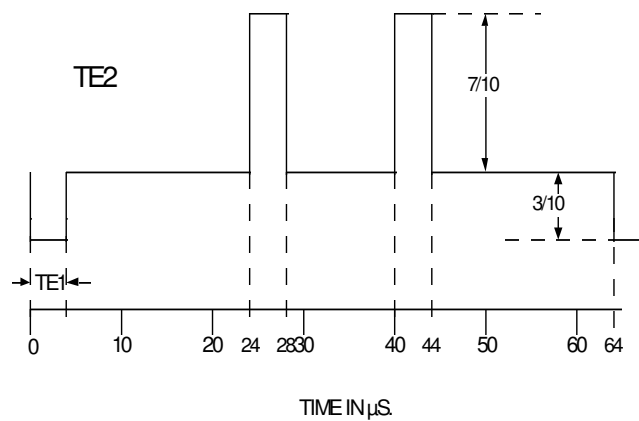

Figure 7. Test Pattern Generator

15.11 Sound Section

The oscillator is fully integrated and does not require any external components. An internal low-pass filter and matched structure provide very low harmonics levels.

The sound modulator system consists of an FM modulator incorporating the sound subcarrier oscillator. The audio input signal is AC-coupled into the amplifier, which then drives the modulator. For mono applications, the audio pre-emphasis circuit is a high-pass filter with an external capacitor and an internal resistor (106 K Ω typical).

The recommended capacitor value for BG standard (with a time constant of 50 μ S) is 470 pF.

The recommended capacitor value for M/N standard (with a time constant of 75 μ S) is 750 pF.

The sound reference divider is a programmable divide-by-128 or divide-by-64, resulting in a reference frequency of 31.25 kHz or 62.5 kHz with a 4.0-MHz crystal.

This reference frequency can be selected by bus (bit SREF), depending on the application. For instance, when the audio bandwidth is required to be extended (for stereo application), it is possible to select the higher value (62.5 kHz) to avoid any interference between the reference and the audio signals.

For stereo applications, the audio signal is already encoded in the baseband stereo encoder. It is not necessary to use a pre-emphasis, and in this case the pre-emphasis capacitor must be removed.

Sometimes for the same application it is useful to increase the FM deviation. To increase FM deviation, replace the original pre-emphasis capacitor with a fixed 100-nF capacitor. Adding this value boosts the deviation and does not create a pre-emphasis.

Without pre-emphasis, the audio bandwidth extends to 60 kHz.

To increase the audio bandwidth at low frequencies it is recommended to change the sound PLL loop filter. It is also recommended to increase the values of the loop filter capacitors. The recommended values are 1 μ F and 100 nF.

It is possible to create a peak for the low frequencies (from 30 to 80 Hz) by adjusting the resistor of the sound loop filter. A flat response is given with a value of 5.6 K Ω but this value can be set to 4.7 K Ω . This gives a peak of about 1 dB at 40 Hz and extends the low-frequency cut-off to 28 Hz.

The following figure plots the resulting bandwidth for low frequencies and for the whole bandwidth (up to 60 kHz).

The first chart represents the audio bandwidth for low frequencies (20 to 150 Hz) for two sets of sound loop filters. The first set with 1 μ F + 100 nF + 5.6 K Ω gives a flat response. The second set with 1 μ F + 100 nF + 4.7 K Ω gives a peak of about 1 dB at 60 Hz. It is possible to adjust this peak by changing the resistor value.