



Chipsmall Limited consists of a professional team with an average of over 10 year of expertise in the distribution of electronic components. Based in Hongkong, we have already established firm and mutual-benefit business relationships with customers from,Europe,America and south Asia,supplying obsolete and hard-to-find components to meet their specific needs.

With the principle of “Quality Parts,Customers Priority,Honest Operation,and Considerate Service”,our business mainly focus on the distribution of electronic components. Line cards we deal with include Microchip,ALPS,ROHM,Xilinx,Pulse,ON,Everlight and Freescale. Main products comprise IC,Modules,Potentiometer,IC Socket,Relay,Connector.Our parts cover such applications as commercial,industrial, and automotives areas.

We are looking forward to setting up business relationship with you and hope to provide you with the best service and solution. Let us make a better world for our industry!



Contact us

Tel: +86-755-8981 8866 Fax: +86-755-8427 6832

Email & Skype: info@chipsmall.com Web: www.chipsmall.com

Address: A1208, Overseas Decoration Building, #122 Zhenhua RD., Futian, Shenzhen, China



High Voltage Thyristor \ Diode Module

 $V_{RRM} = 2 \times 2000 \text{ V}$
 $I_{TAV} = 165 \text{ A}$
 $V_T = 1.08 \text{ V}$

Phase leg

Part number

MCD161-20io1

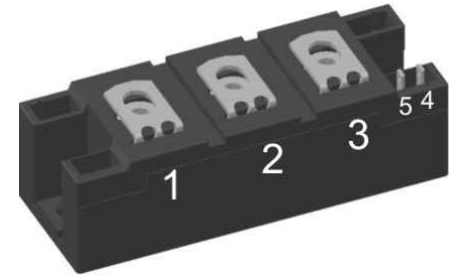

Backside: isolated

E72873

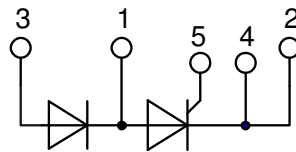

Features / Advantages:

- Thyristor for line frequency
- Planar passivated chip
- Long-term stability
- Direct Copper Bonded Al₂O₃-ceramic

Applications:

- Line rectifying 50/60 Hz
- Softstart AC motor control
- DC Motor control
- Power converter
- AC power control
- Lighting and temperature control

Package: Y4

- Isolation Voltage: 3600 V~
- Industry standard outline
- RoHS compliant
- Soldering pins for PCB mounting
- Base plate: DCB ceramic
- Reduced weight
- Advanced power cycling

Terms .Conditions of usage:

The data contained in this product data sheet is exclusively intended for technically trained staff. The user will have to evaluate the suitability of the product for the intended application and the completeness of the product data with respect to his application. The specifications of our components may not be considered as an assurance of component characteristics. The information in the valid application- and assembly notes must be considered. Should you require product information in excess of the data given in this product data sheet or which concerns the specific application of your product, please contact your local sales office.

Due to technical requirements our product may contain dangerous substances. For information on the types in question please contact your local sales office.

Should you intend to use the product in aviation, in health or life endangering or life support applications, please notify. For any such application we urgently recommend

- to perform joint risk and quality assessments;

- the conclusion of quality agreements;

- to establish joint measures of an ongoing product survey, and that we may make delivery dependent on the realization of any such measures.

| Rectifier | | | | Ratings | | | |
|----------------|--|---|-------------------------|---------|-------|-------------------|--|
| Symbol | Definition | Conditions | min. | typ. | max. | Unit | |
| $V_{RSM/DSM}$ | max. non-repetitive reverse/forward blocking voltage | $T_{VJ} = 25^{\circ}C$ | | | 2100 | V | |
| $V_{RRM/DRM}$ | max. repetitive reverse/forward blocking voltage | $T_{VJ} = 25^{\circ}C$ | | | 2000 | V | |
| I_{RD} | reverse current, drain current | $V_{R/D} = 2000\text{ V}$ | $T_{VJ} = 25^{\circ}C$ | | 400 | μA | |
| | | $V_{R/D} = 2000\text{ V}$ | $T_{VJ} = 125^{\circ}C$ | | 40 | mA | |
| V_T | forward voltage drop | $I_T = 150\text{ A}$ | $T_{VJ} = 25^{\circ}C$ | | 1.14 | V | |
| | | $I_T = 300\text{ A}$ | | | 1.36 | V | |
| | | $I_T = 150\text{ A}$ | $T_{VJ} = 125^{\circ}C$ | | 1.08 | V | |
| | | $I_T = 300\text{ A}$ | | | 1.36 | V | |
| I_{TAV} | average forward current | $T_C = 85^{\circ}C$ | $T_{VJ} = 125^{\circ}C$ | | 165 | A | |
| $I_{T(RMS)}$ | RMS forward current | 180° sine | | | 300 | A | |
| V_{T0} | threshold voltage | } for power loss calculation only | $T_{VJ} = 125^{\circ}C$ | | 0.80 | V | |
| r_T | slope resistance | | | | 1.6 | m Ω | |
| R_{thJC} | thermal resistance junction to case | | | | 0.155 | K/W | |
| R_{thCH} | thermal resistance case to heatsink | | | 0.070 | | K/W | |
| P_{tot} | total power dissipation | | $T_C = 25^{\circ}C$ | | 645 | W | |
| I_{TSM} | max. forward surge current | $t = 10\text{ ms}; (50\text{ Hz}), \text{ sine}$ | $T_{VJ} = 45^{\circ}C$ | | 6.00 | kA | |
| | | $t = 8,3\text{ ms}; (60\text{ Hz}), \text{ sine}$ | $V_R = 0\text{ V}$ | | 6.48 | kA | |
| | | $t = 10\text{ ms}; (50\text{ Hz}), \text{ sine}$ | $T_{VJ} = 125^{\circ}C$ | | 5.10 | kA | |
| | | $t = 8,3\text{ ms}; (60\text{ Hz}), \text{ sine}$ | $V_R = 0\text{ V}$ | | 5.51 | kA | |
| I^2t | value for fusing | $t = 10\text{ ms}; (50\text{ Hz}), \text{ sine}$ | $T_{VJ} = 45^{\circ}C$ | | 180.0 | kA ² s | |
| | | $t = 8,3\text{ ms}; (60\text{ Hz}), \text{ sine}$ | $V_R = 0\text{ V}$ | | 174.7 | kA ² s | |
| | | $t = 10\text{ ms}; (50\text{ Hz}), \text{ sine}$ | $T_{VJ} = 125^{\circ}C$ | | 130.1 | kA ² s | |
| | | $t = 8,3\text{ ms}; (60\text{ Hz}), \text{ sine}$ | $V_R = 0\text{ V}$ | | 126.3 | kA ² s | |
| C_J | junction capacitance | $V_R = 700\text{ V}$ $f = 1\text{ MHz}$ | $T_{VJ} = 25^{\circ}C$ | | 195 | pF | |
| P_{GM} | max. gate power dissipation | $t_p = 30\text{ }\mu s$ | $T_C = 125^{\circ}C$ | | 120 | W | |
| | | $t_p = 500\text{ }\mu s$ | | | 60 | W | |
| P_{GAV} | average gate power dissipation | | | | 8 | W | |
| $(di/dt)_{cr}$ | critical rate of rise of current | $T_{VJ} = 125^{\circ}C; f = 50\text{ Hz}$ repetitive, $I_T = 500\text{ A}$ | | | 150 | A/ μs | |
| | | $t_p = 200\text{ }\mu s; di_G/dt = 0.5\text{ A}/\mu s;$ $I_G = 0.5\text{ A}; V = \frac{2}{3} V_{DRM}$ non-repet., $I_T = 160\text{ A}$ | | | 500 | A/ μs | |
| $(dv/dt)_{cr}$ | critical rate of rise of voltage | $V = \frac{2}{3} V_{DRM}$ $R_{GK} = \infty; \text{ method 1 (linear voltage rise)}$ | $T_{VJ} = 125^{\circ}C$ | | 1000 | V/ μs | |
| V_{GT} | gate trigger voltage | $V_D = 6\text{ V}$ | $T_{VJ} = 25^{\circ}C$ | | 2 | V | |
| | | | $T_{VJ} = -40^{\circ}C$ | | 2.6 | V | |
| I_{GT} | gate trigger current | $V_D = 6\text{ V}$ | $T_{VJ} = 25^{\circ}C$ | | 150 | mA | |
| | | | $T_{VJ} = -40^{\circ}C$ | | 200 | mA | |
| V_{GD} | gate non-trigger voltage | $V_D = \frac{2}{3} V_{DRM}$ | $T_{VJ} = 125^{\circ}C$ | | 0.25 | V | |
| I_{GD} | gate non-trigger current | | | | 10 | mA | |
| I_L | latching current | $t_p = 30\text{ }\mu s$ | $T_{VJ} = 25^{\circ}C$ | | 200 | mA | |
| | | $I_G = 0.45\text{ A}; di_G/dt = 0.45\text{ A}/\mu s$ | | | | | |
| I_H | holding current | $V_D = 6\text{ V}$ $R_{GK} = \infty$ | $T_{VJ} = 25^{\circ}C$ | | 200 | mA | |
| t_{gd} | gate controlled delay time | $V_D = \frac{1}{2} V_{DRM}$ | $T_{VJ} = 25^{\circ}C$ | | 2 | μs | |
| | | $I_G = 0.5\text{ A}; di_G/dt = 0.5\text{ A}/\mu s$ | | | | | |
| t_q | turn-off time | $V_R = 100\text{ V}; I_T = 160\text{ A}; V = \frac{2}{3} V_{DRM}$ $di/dt = 10\text{ A}/\mu s$ $dv/dt = 20\text{ V}/\mu s$ $t_p = 200\text{ }\mu s$ | $T_{VJ} = 100^{\circ}C$ | | 150 | μs | |

| Package Y4 | | | | Ratings | | | |
|---------------|--|----------------------|-------------------------------------|---------|------|------|--|
| Symbol | Definition | Conditions | min. | typ. | max. | Unit | |
| I_{RMS} | RMS current | per terminal | | | 300 | A | |
| T_{VJ} | virtual junction temperature | | -40 | | 125 | °C | |
| T_{op} | operation temperature | | -40 | | 100 | °C | |
| T_{stg} | storage temperature | | -40 | | 125 | °C | |
| Weight | | | | | 150 | g | |
| M_D | mounting torque | | 2.25 | | 2.75 | Nm | |
| M_T | terminal torque | | 4.5 | | 5.5 | Nm | |
| $d_{Spp/App}$ | creepage distance on surface striking distance through air | terminal to terminal | 14.0 | 10.0 | | mm | |
| $d_{Spb/Apb}$ | | terminal to backside | 16.0 | 16.0 | | mm | |
| V_{ISOL} | isolation voltage | t = 1 second | | | 3600 | V | |
| | | t = 1 minute | 50/60 Hz, RMS; $I_{ISOL} \leq 1$ mA | | 3000 | V | |

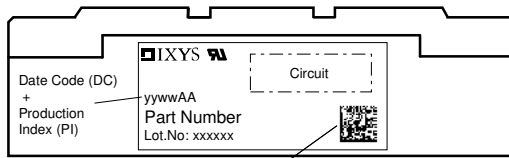

Data Matrix: part no. (1-19), DC + PI (20-25), lot.no.# (26-31), blank (32), serial no.# (33-36)

| Ordering | Ordering Number | Marking on Product | Delivery Mode | Quantity | Code No. |
|----------|-----------------|--------------------|---------------|----------|----------|
| Standard | MCD161-20io1 | MCD161-20io1 | Box | 6 | 476293 |

Equivalent Circuits for Simulation

* on die level

$T_{VJ} = 125\text{ °C}$



Thyristor

| | | | |
|--------------|--------------------|-----|----|
| $V_{0\ max}$ | threshold voltage | 0.8 | V |
| $R_{0\ max}$ | slope resistance * | 0.9 | mΩ |

Outlines Y4

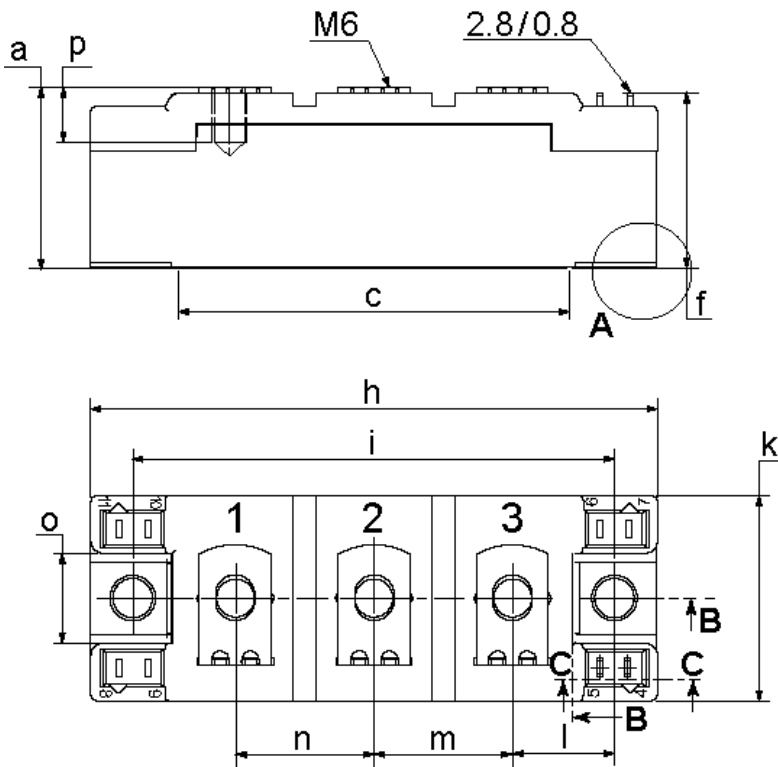

| Dim. | MIN [mm] | MAX [mm] | MIN [inch] | MAX [inch] |
|------|-----------|----------|------------|------------|
| a | 30.0 | 30.6 | 1.181 | 1.205 |
| b | typ. 0.25 | | typ. 0.010 | |
| c | 64.0 | 65.0 | 2.520 | 2.559 |
| d | 6.5 | 7.0 | 0.256 | 0.275 |
| e | 4.9 | 5.1 | 0.193 | 0.201 |
| f | 28.6 | 29.2 | 1.126 | 1.150 |
| g | 7.3 | 7.7 | 0.287 | 0.303 |
| h | 93.5 | 94.5 | 3.681 | 3.720 |
| i | 79.5 | 80.5 | 3.130 | 3.169 |
| j | 4.8 | 5.2 | 0.189 | 0.205 |
| k | 33.4 | 34.0 | 1.315 | 1.339 |
| l | 16.7 | 17.3 | 0.657 | 0.681 |
| m | 22.7 | 23.3 | 0.894 | 0.917 |
| n | 22.7 | 23.3 | 0.894 | 0.917 |
| o | 14.0 | 15.0 | 0.551 | 0.591 |
| p | typ. 10.5 | | typ. 0.413 | |
| r | 1.8 | 2.4 | 0.071 | 0.041 |

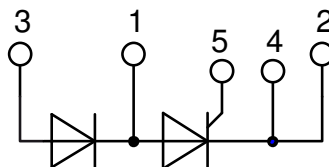
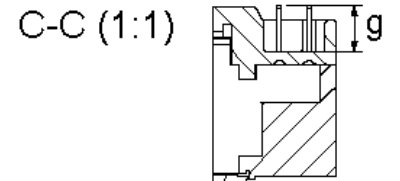
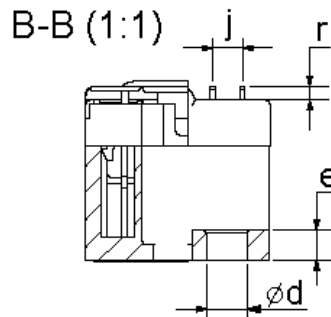
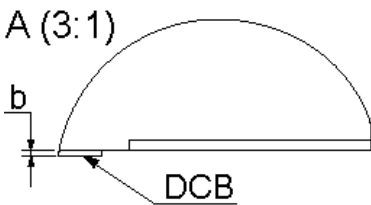

Thyristor

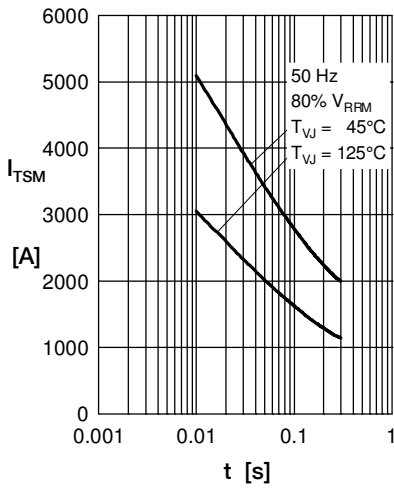

Fig. 1 Surge overload current I_{TSM} , I_{FSM} : Crest value, t: duration

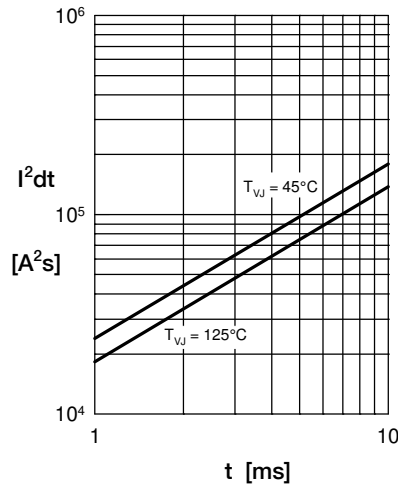

Fig. 2 I^2t versus time (1-10 ms)

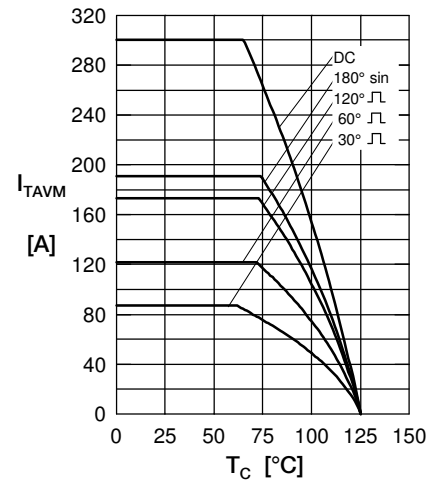

Fig. 3 Max. forward current at case temperature

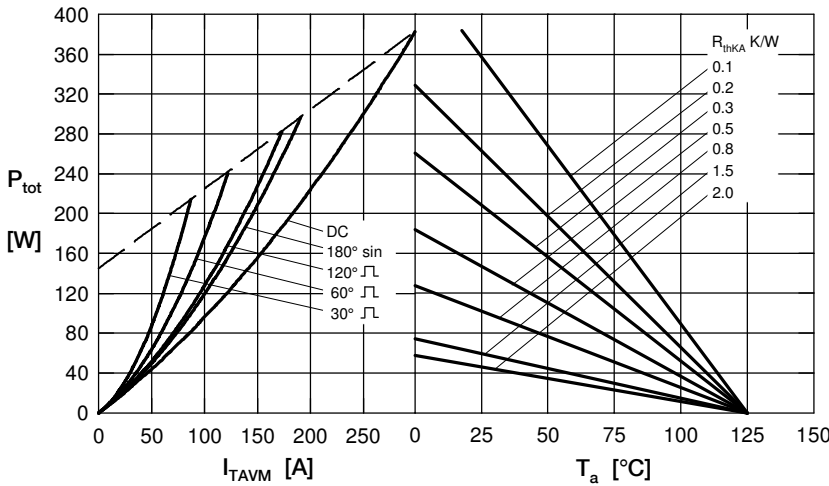

Fig. 4 Power dissipation vs. on-state current & ambient temperature (per thyristor or diode)

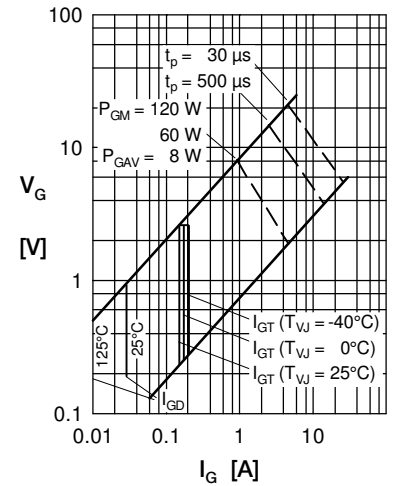

Fig. 5 Gate trigger characteristics

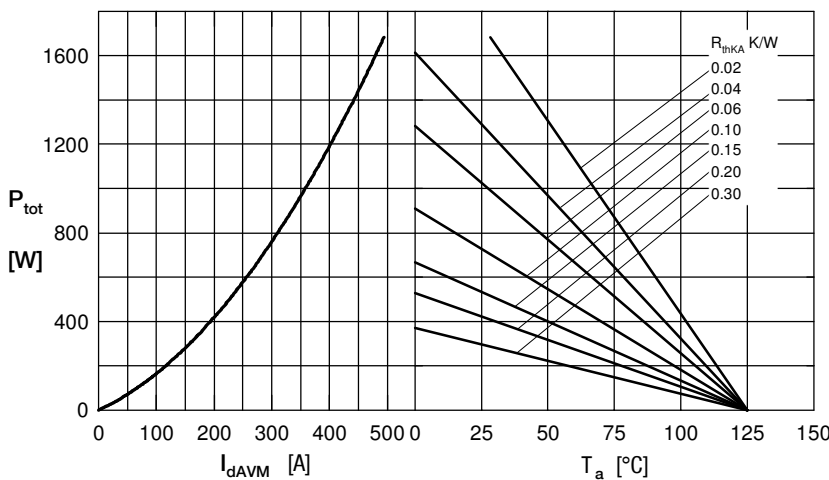

Fig. 6 Three phase rectifier bridge: Power dissipation versus direct output current and ambient temperature

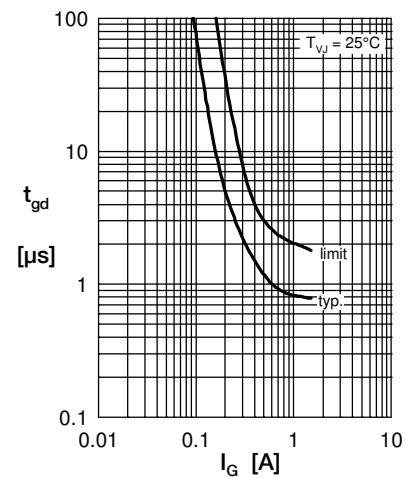
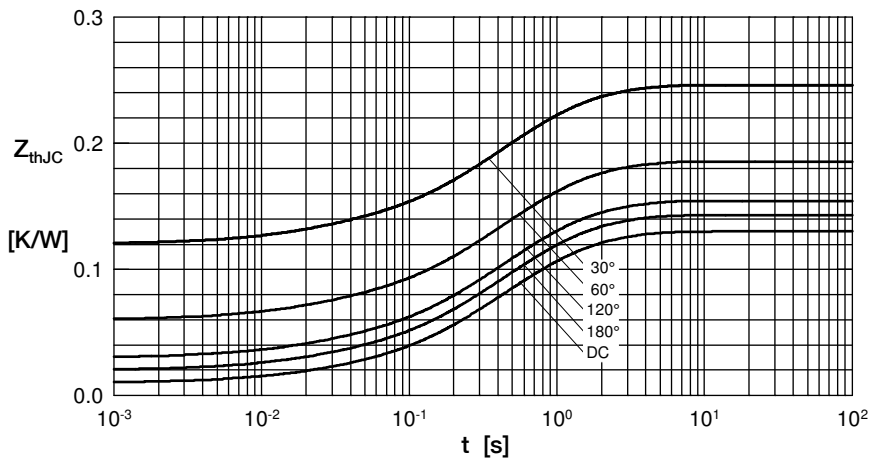

Fig. 7 Gate trigger delay time

Rectifier



R_{thJC} for various conduction angles d :

| d | R_{thJC} [K/W] |
|------|------------------|
| DC | 0.155 |
| 180° | 0.171 |
| 120° | 0.184 |
| 60° | 0.222 |
| 30° | 0.294 |

Constants for Z_{thJC} calculation:

| i | R_{thi} [K/W] | t_i [s] |
|-----|-----------------|-----------|
| 1 | 0.012 | 0.00014 |
| 2 | 0.008 | 0.019 |
| 3 | 0.030 | 0.180 |
| 4 | 0.073 | 0.520 |
| 5 | 0.032 | 1.600 |

Fig. 8 Transient thermal impedance junction to case at various conduction angles