



Chipsmall Limited consists of a professional team with an average of over 10 year of expertise in the distribution of electronic components. Based in Hongkong, we have already established firm and mutual-benefit business relationships with customers from,Europe,America and south Asia,supplying obsolete and hard-to-find components to meet their specific needs.

With the principle of “Quality Parts,Customers Priority,Honest Operation,and Considerate Service”,our business mainly focus on the distribution of electronic components. Line cards we deal with include Microchip,ALPS,ROHM,Xilinx,Pulse,ON,Everlight and Freescale. Main products comprise IC,Modules,Potentiometer,IC Socket,Relay,Connector.Our parts cover such applications as commercial,industrial, and automotives areas.

We are looking forward to setting up business relationship with you and hope to provide you with the best service and solution. Let us make a better world for our industry!



## Contact us

Tel: +86-755-8981 8866 Fax: +86-755-8427 6832

Email & Skype: info@chipsmall.com Web: www.chipsmall.com

Address: A1208, Overseas Decoration Building, #122 Zhenhua RD., Futian, Shenzhen, China



# Energy Management Smart Modular Power Analyzer Type WM40 96

CARLO GAVAZZI

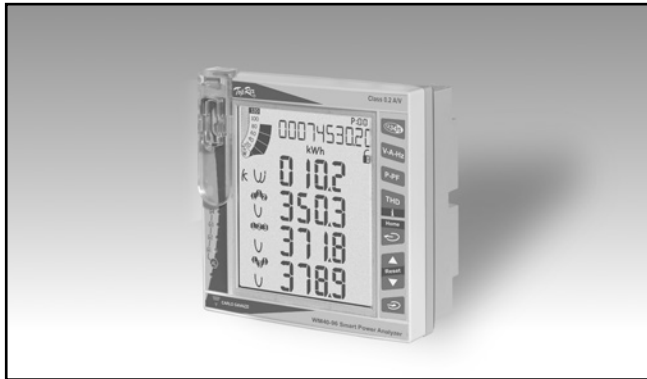

- Front protection degree: IP65, NEMA4x, NEMA12
- Optical front communication port (ANSI type 2)
- Up to one RS232 and RS485 port (on request)
- Communication protocol: MODBUS-RTU
- MODBUS TCP/IP Ethernet port (on request)
- BACnet-IP over Ethernet port (on request)
- BACnet MS/TP over RS485, BTL approved (on request)
- Ethernet/IP port, ODVA approved (on request)
- Profibus DP V0 port (on request)
- Up to 6 digital inputs for tariff selection, “dmd” synch, gas/water (hot-cold) and remote heating metering (on request)
- Up to 8 static outputs (pulse, alarm, remote control) (on request)
- Up to 6 relay outputs (pulse, alarm, remote control) (on request)
- Up to 16 freely configurable alarms with OR/AND logic linkable with up to either 4 relay outputs or up to 6 static outputs (on request)
- Up to 4 analogue outputs (+20mA, +10VDC) (on request)
- Class 0.5S (kWh) according to EN62053-22
- Class C (kWh) according to EN50470-3
- Class 2 (kvarh) according to EN62053-23
- Accuracy  $\pm 0.2\%$  RDG (current/voltage)
- Instantaneous variables readout: 4x4 DGT
- Energies readout: 9+1 DGT
- System variables: VLL, VLN, A, VA, W, var, PF, Hz, phase-sequence, phase-asymmetry and phaseloss.
- Single phase variables: VLL, VLN, AL, An (calculated or real depending on the option), VA, W, var, PF
- Both system and singles phase variables with average, max and min calculation
- Direct neutral current measurement (on request)
- Harmonic analysis (FFT) up to the 32nd harmonic (current and voltage) with harmonics source detection (imported/exported, only via serial port)
- Energy measurements (imported/exported): total and partial kWh and kvarh (inductive and capacitive) or based on 6 different tariffs (on request)
- Energy measurements according to ANSI C12.20, CA 0.5, ANSI C12.1 (revenue grade)
- Gas, cold water, hot water, remote heating measurements (on request)
- Run hours counter (8+2 DGT)
- Real time clock function
- Data stamping of up to 10,000 events: alarm, min, max, digital input status, digital output status, resets, programming changing (on request)
- Application adaptable display and programming procedure (Easyprog function)
- Universal power supply:  
24-48 VDC/AC, 100-240 VDC/AC
- Front dimensions: 96x96 mm

## Product Description

Three-phase smart power analyzer with built-in application configuration system and LCD data displaying. Particularly recommended for the measurement of the main electrical variables.

WM40 is based on a modular housing for panel mounting with IP65 (front) protection degree. Moreover the analyzer can be provided with digital outputs that can be either for pulse proportional to the active and reactive total, partial and tariff energy being measured or/and for alarm outputs.

The instrument is equipped with optical communication port, further I/O's such as: RS485/RS232, Ethernet, BACnet-IP, BACnet MS/TP or Profibus DP V0 communication ports, pulse and alarm outputs and 6 digital inputs or analogue outputs are available on request. Parameters programming and data reading can be easily performed by means of WM3040Soft.



## How to order

**WM40-96 AV5 3 H R4 CT S1 XX**



## Type Selection

Range codes	System	Power supply	A Inputs/Outputs
<b>AV4:</b> 400/690V <sub>LL</sub> AC 1(2)A V <sub>LN</sub> : 160V to 480V <sub>LN</sub> V <sub>LL</sub> : 277V to 830V <sub>LL</sub>	<b>3:</b> balanced and unbalanced load; 3-phase, 4-wire; 3-phase, 3-wire; 2-phase, 3-wire; 1-phase, 2-wire	<b>H:</b> 100-240 +/-10% (90 to 255) VDC/AC (50/60 Hz) <b>L:</b> 24-48 +/-15% (20 to 55) VDC/AC (50/60 Hz)	<b>XX:</b> none <b>R2:</b> Dual channel relay output <b>O2:</b> Dual channel static output <b>A2:</b> Dual channel 20mADC output <b>V2:</b> Dual channel 10VDC output <b>R4:</b> Advanced six channel digital inputs + four channel relay outputs + OR/AND alarm logic management <b>O6:</b> Advanced six channel digital inputs + six channel static outputs + OR/AND alarm logic management
<b>AV5:</b> 400/690V <sub>LL</sub> AC 5(6)A V <sub>LN</sub> : 160V to 480V <sub>LN</sub> V <sub>LL</sub> : 277V to 830V <sub>LL</sub>			
<b>AV6:</b> 100/208V <sub>LL</sub> AC 5(6)A V <sub>LN</sub> : 40V to 144V <sub>LN</sub> V <sub>LL</sub> : 70V to 250V <sub>LL</sub>			
<b>AV7:</b> 100/208V <sub>LL</sub> AC 1(2)A V <sub>LN</sub> : 40V to 144V <sub>LN</sub> V <sub>LL</sub> : 70V to 250V <sub>LL</sub>			
	Communication and data S.		
	<b>XX:</b> none <b>S1:</b> RS485/RS232 port <b>S3:</b> RS485/RS232 port with data stamping <b>E2:</b> Ethernet / Internet port <b>E3:</b> Ethernet / Internet port with data stamping <b>B1:</b> BACnet (IP) over Ethernet <b>B2:</b> BACnet (IP) over Ethernet with data stamping <b>B3:</b> BACnet (MS/TP) over RS485 <b>B4:</b> BACnet (MS/TP) over RS485 with data stamping <b>E6:</b> Ethernet/IP port <b>E7:</b> Ethernet/IP port with data stamping <b>P1:</b> Profibus DP/V0 port <b>P2:</b> Profibus DP/V0 port with data stamping	Options	<b>XX:</b> none
B Inputs/Outputs			
<b>XX:</b> none <b>A2:</b> Dual channel 20mADC output <b>V2:</b> Dual channel 10VDC output <b>TP:</b> One temperature and one process signal input <b>CT:</b> Direct neutral current measurement + One temperature and one process signal input			

## Position of modules and combination

Ref	Description	Main features	Part number	Pos. A	Pos. B	Pos. C
1	WM40 base provided with display, power supply, measuring inputs, optical front communication port.	• Inputs/system: AV5.3 • Power supply: H	WM40 AV5 3 H			
2		• Inputs/system: AV6.3 • Power supply: H	WM40 AV6 3 H			
3		• Inputs/system: AV4.3 • Power supply: H	WM40 AV4 3 H			
4		• Inputs/system: AV7.3 • Power supply: H	WM40 AV7 3 H			
5		• Inputs/system: AV5.3 • Power supply: L	WM40 AV5 3 L			
6		• Inputs/system: AV6.3 • Power supply: L	WM40 AV6 3 L			
7		• Inputs/system: AV4.3 • Power supply: L	WM40 AV4 3 L			
8		• Inputs/system: AV7.3 • Power supply: L	WM40 AV7 3 L			
9	Dual relay output (SPDT)	• 2-channel • Alarm or/and pulse output	M O R2	X		
10	Dual static output (AC/DC Opto-Mos)	• 2-channel • Alarm or/and pulse output	M O O2	X		
11	Dual analogue output (+20mADC)	• 2-channel	M O A2	X	X	
12	Dual analogue output (+10VDC)	• 2-channel	M O V2	X	X	
13	RS485 / RS232 port module	• Max. 115.2 Kbps	M C 485 232			X
14	Ethernet/TCP IP port module	• RJ45 10/100 BaseT	M C ETH			X
15	BACnet-IP port module	• Based on Ethernet bus	M C BAC IP			X
16	BACnet MS/TP port module	• Over RS485	M C BAC MS			X
17	BACnet MS/TP port module	• Over RS485 • Data Stamping	M C BAC MS M			X
18	Combined digital inputs and Relay outputs (SPDT)	• 6-input channels • 4-output channels • Complex tariff management • OR/AND logic management	M F I6 R4		X	
19	Combined digital inputs and Static outputs (AC/DC Opto-Mos)	• 6-input channels • 6-output channels • Complex tariff management. • OR/AND logic management	M F I6 O6		X	
20	RS485 / RS232 port module with integrated Memory	• Max. 115.2 Kbps • Data stamping	M C 485 232 M			X
21	Ethernet port module with integrated Memory	• RJ45 10/100 BaseT • Data Stamping	M C ETH M			X
22	BACnet over IP port module with integrated Memory	• Based on Ethernet bus • Data Stamping	M C BAC IP M			X
23	Temperature + Process signal measurements (°C/°F)	• "Pt" type input • 20mA input	M A T P		X	
24	Direct neutral current measurement + Temperature + Process signal measurements (°C/°F)	• As above + signal input like a common current input (CT ratio etc.)	M A T P N		X	
25	Ethernet/IP port	• Based on Ethernet	M C E I			X
26	Ethernet/IP port with integrated Memory	• Based on Ethernet	M C E I M			X
27	Profibus module	• Profibus DP V0 • Over RS485	M C P B			X
28	Profibus module with integrated memory	• Profibus DP V0 • Over RS485 • Data stamping	M C P B M			X

**NOTE:** The position of the modules shall respect the sequence A-B-C. Possible arrangements are M, M-A, M-B, M-C, M-A-B, M-A-C, M-B-C and M-A-B-C where "M" is the basic module.

**It is possible to use the WM40-96 without any additional module as a simple indicator.**

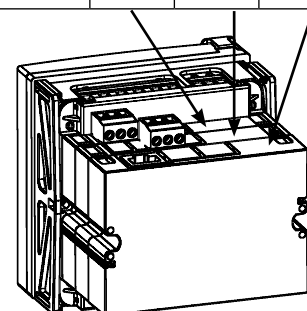

## Input specifications

<b>Rated inputs</b>	System type: 1, 2 or 3-phase	<b>Start up current AV4, AV7</b>	1mA
Current type	Galvanic insulation by means of built-in CT's	<b>Energy additional errors</b>	According to EN62053-22, ANSI C12.20,
Current range (by CT)	AV5 and AV6: 5(6)A AV4 and AV7: 1(2)A	Influence quantities	Class B or C according to EN50470-3, EN62053-23, ANSI C12.1
Voltage (by direct connection or VT/PT)	AV4, AV5: 400/690VLL; AV6, AV7: 100/208VLL	<b>Total Harmonic Distortion (THD)</b>	±1% FS (FS: 100%) AV4: Imin: 5mARMS; Imax: 3A; Umin: 30VRMS; Umax: 679Vp AV5: Imin: 5mARMS; Imax: 15Ap; Umin: 30VRMS; Umax: 679Vp AV6: Imin: 5mARMS; Imax: 15Ap; Umin: 30VRMS; Umax: 204Vp AV7: Imin: 5mARMS; Imax: 3A; Umin: 30VRMS; Umax: 204Vp
<b>Accuracy</b> (Display + RS485) (@25°C ±5°C, R.H. ≤60%, 48 to 62 Hz)	In: see below, Un: see below	<b>Total Demand Distortion (TDD)</b>	±1% FS (FS: 100%) Imin: 5mA RMS; Imax: 15Ap
AV4 model	In: 1A, Imax: 2A; Un: 160 to 480VLN (277 to 830VLL)	<b>K-Factor and factor K</b>	±(0.5%RDG+1DGT)
AV5 model	In: 5A, Imax: 6A; Un: 160 to 480VLN (277 to 830VLL)	<b>Temperature drift</b>	≤200ppm/°C
AV6 model	In: 5A, Imax: 6A; Un: 40 to 144VLN (70 to 250VLL)	<b>Sampling rate</b>	3200 samples/s @ 50Hz, 3840 samples/s @ 60Hz
AV7 model	In: 1A, Imax: 2A; Un: 40 to 144VLN (70 to 250VLL)	<b>Measurements</b>	See "List of the variables that can be connected to:" TRMS measurements of distorted wave forms.
Current AV4, AV5, AV6, AV7 models	From 0.01In to 0.05In: ±(0.5% RDG +2DGT) From 0.05In to Imax: ±(0.2% RDG +2DGT)	Method	By means of CT's
Phase-neutral voltage	In the range Un: ±(0,2% RDG +1DGT)	Coupling type	
Phase-phase voltage	In the range Un: ±(0.5% RDG +1DGT)	<b>Crest factor</b>	AV5, AV6: ≤3 (15A max. peak) AV4, AV7: ≤3 (3A max. peak)
Frequency	±0.01Hz (45 to 65Hz)	<b>Current Overloads</b>	
Active and Apparent power	From 0.01In to 0.05In, PF 1: ±(1%RDG+1DGT) From 0.05In to Imax PF 0.5L, PF1, PF0.8C: ±(0.5%RDG+1DGT)	Continuous (AV5 and AV6)	6A, @ 50Hz/60Hz
Power Factor	±[0.001+0.5% (1.000 - "PF RDG")]	Continuous (AV4 and AV7)	2A, @ 50Hz/60Hz
Reactive power	From 0.02In to 0.05In, senφ 1: ±(1.5%RDG+1DGT) From 0.05In to Imax, senφ 1: ±(1%RDG+1DGT)	For 500ms (AV5 and AV6)	120A, @ 50Hz/60Hz
Active energy	From 0.05In to 0.1In, senφ 0.5L/C: ±(1.5%RDG+1DGT) From 0.1In to Imax, senφ 0.5L/C: ±(1%RDG+1DGT)	For 500ms (AV4 and AV7)	40A, @ 50Hz/60Hz
Reactive energy	Class 0.5S according to EN62053-22, ANSI C12.20 Class C according to EN50470-3.	<b>Voltage Overloads</b>	
Start up current AV5, AV6	Class 2 according to EN62053-23, ANSI C12.1. 5mA	Continuous	1.2 Un
		For 500ms	2 Un
		<b>Input impedance</b>	
		400VL-L (AV4 and AV5)	> 1.6MΩ
		208VL-L (AV6 and AV7)	> 1.6MΩ
		5(6)A (AV5 and AV6)	< 0.2VA
		1(2)A (AV4 and AV7)	< 0.2VA
		<b>Frequency</b>	40 to 440 Hz



## Output specifications

<b>Relay outputs (M O R2)</b>			
Physical outputs	2 (max. 1 module per instrument)	Pulse	Signal retransmission
Purpose	For either alarm output or pulse output		
Type	Relay, SPDT type AC 1-5A @ 250VAC; AC 15-1A @ 250VAC	Pulse type	
Configuration	By means of the front keypad	Pulse duration	
Function	The outputs can work as alarm outputs but also as pulse outputs, remote controlled outputs, or in any other combination.	Remote controlled outputs	
Alarms	Up alarm and down alarm and windows alarm (in and out) linked to the virtual alarms, other details see Virtual alarms	Insulation	
Min. response time	≤200ms, filters excluded. Set-point on-time delay: "0 s".	<b>20mA analogue outputs (M O A2)</b>	
Pulse		Number of outputs	2 per module (max. 2 modules per instrument)
Signal retransmission	Total: +kWh, -kWh, +kvarh, -kvarh. Partial: +kWh, -kWh, +kvarh, -kvarh.	Accuracy (@ 25°C ±5°C, R.H. ≤60%)	±0.2%FS
Pulse type	Programmable from 0.001 to 10.00 kWh/kvarh per pulse. The above listed variables can be connected to any output.	Range	0 to 20mA
Pulse duration	≥100ms <120msec (ON), ≥120ms (OFF), according to EN62052-31	Configuration	By means of the front keypad
Remote controlled outputs	The activation of the outputs is managed through the serial communication port	Signal retransmission	The signal output can be connected to any instantaneous variable available in the table "List of the variables that can be connected to".
Insulation	See "Insulation between inputs and outputs" table	Scaling factor	Programmable within the whole range of retransmission.
<b>Static outputs (M O O2)</b>		Response time	≤400 ms typical (filter excluded)
Physical outputs	Opto-Mos type 2 (max. 1 module per instrument)	Ripple	≤1% (according to IEC 60688, EN 60688)
Purpose	For either pulse output or alarm output	Total temperature drift	≤500 ppm/°C
Signal	V <sub>ON</sub> : 2.5VAC/DC/max. 100mA V <sub>OFF</sub> : 42VDC max.	Load	≤600Ω
Configuration	By means of the front keypad	Insulation	See "Insulation between inputs and outputs" table
Function	The outputs can work as alarm outputs but also as pulse outputs, remote controlled outputs, or in any other combination.	<b>10VDC analogue outputs (M O V2)</b>	
Alarms	Up alarm and down alarm linked to the virtual alarms, other details see Virtual alarms	Number of outputs	2 per module (max. 2 modules per instrument)
Min. response time	≤200ms, filters excluded. Set-point on-time delay: "0 s".	Accuracy (@ 25°C ±5°C, R.H. ≤60%)	±0.2%FS
		Range	0 to 10 VDC
		Configuration	By means of the front keypad
		Signal retransmission	The signal output can be connected to any instantaneous variable available in the table "List of the variables that can be connected to".



## Output specifications (cont.)

Scaling factor	Programmable within the whole range of retransmission.	Baud-rate	Selectable: 9.6k, 19.2k, 38.4k, 115.2k bit/s
Response time	≤400 ms typical (filter excluded)	Note	With the rotary switch (on the back of the basic unit) in lock position the modification of the programming parameters and the reset command by means of the serial communication is not allowed. In this case just the data reading is allowed. See "Insulation between inputs and outputs" table
Ripple	≤1% (according to IEC 60688, EN 60688)		
Total temperature drift	≤350 ppm/°C		
Load	≥10kΩ		
Insulation	See "Insulation between inputs and outputs" table		
<b>RS485 serial port (M C 485 232 on request)</b>			
RS485 Type	Multidrop, bidirectional (static and dynamic variables)	Insulation	
Connections	2-wire Max. distance 1000m, termination directly on the module	Module with data stamping and event recording memory	
Addresses	247, selectable by means of the front key-pad	(M C 485 232 M)	
Protocol	MODBUS/JBUS (RTU)	Event stamping	
Data (bidirectional)		Type of data	Alarm, min, max, digital input status, digital output status as remote control, resets.
Dynamic (reading only)	System and phase variables: see table "List of variables..."	Stamping format	Date (dd:MM:yy) and hour (hh:mm:ss) reference.
Static (reading and writing only)	All the configuration parameters.	Number of events	Up to 10,000
Data format	1 start bit, 8 data bit, no/ even/odd parity, 1 stop bit	Data management type	FIFO
Baud-rate	Selectable: 9.6k, 19.2k, 38.4k, 115.2k bit/s	Data stamping	
Driver input capability	1/5 unit load. Maximum 160 transceivers on the same bus.	Type of data	Any measured variable can be stored in the memory.
Note	With the rotary switch (on the back of the basic unit) in lock position the modification of the programming parameters and the reset command by means of the serial communication is not allowed. In this case just the data reading is allowed. See "Insulation between inputs and outputs" table	Stamping format	Date (dd:MM:yy) and hour (hh:mm:ss) reference.
		Number of variables	Up to 19 different type of variables can be stored.
		Time interval	From 1 minute up to 60 minutes.
		Data management type	FIFO
		Memory type	Data flash
		<b>Ethernet/Internet port (M C ETH on request)</b>	
		Protocols	Modbus TCP/IP
		IP configuration	Static IP / Netmask / Default gateway
		Port	Selectable (default 502)
		Client connections	Max 5 simultaneously
		Connections	RJ45 10/100 BaseTX Max. distance 100m
		Data (bidirectional)	
		Dynamic (reading only)	System and phase variables: see table "List of variables..."
		Static (reading and writing only)	All the configuration parameters.
		Note	With the rotary switch (on the back of the basic unit) in lock position the modification of the programming parameters and the reset command by means of the serial communication is not
<b>RS232 port (on request)</b>			
Type	Bidirectional (static and dynamic variables)		
Connections	3 wires. Max. distance 15m		
Protocol	MODBUS RTU /JBUS		
Data (bidirectional)			
Dynamic (reading only)	System and phase variables: see table "List of variables..."		
Static (reading and writing only)	All the configuration parameters		
Data format	1 start bit, 8 data bit, no/ even/odd parity, 1 stop bit		

## Output specifications (cont.)

Insulation	allowed. In this case just the data reading is allowed. See "Insulation between inputs and outputs" table	Data Dynamic (reading only)	System and phase variables (BACnet-IP and Modbus): see table "List of variables"
Module with data stamping and event recording memory		Static (reading and writing only)	All the configuration parameters (Modbus only) With the rotary switch (on the back of the basic unit) in lock position the modification of the programming parameters and the reset command by means of the serial communication is not allowed anymore. In this case just the data reading is allowed.
(M C ETH M) Event stamping Type of data	Alarm, min, max, digital input status, digital output status as remote control, resets.	Note	See "Insulation between inputs and outputs" table
Stamping format	Date (dd:MM:yy) and hour (hh:mm:ss) reference.		
Number of events	Up to 10,000		
Data management type	FIFO		
Data stamping Type of data	Any measured variable can be stored in the memory.	Insulation	
Stamping format	Date (dd:MM:yy) and hour (hh:mm:ss) reference.	Module with data stamping and event recording memory	
Number of variables	Up to 19 different type of variables can be stored.	(M C BAC IP M) Event stamping Type of data	Alarm, min, max, digital input status, digital output status as remote control, resets.
Time interval	From 1 minute up to 60 minutes.	Stamping format	Date (dd:MM:yy) and hour (hh:mm:ss) reference.
Data management type	FIFO	Number of events	Up to 10,000
Memory type	Data flash	Data management type	FIFO
<b>BACnet-IP (on request)</b> Protocols	BACnet-IP (for measurement reading purpose and to write object description) and Modbus TCP/IP (for measurement reading purpose and for programming parameter purpose)	Data stamping Type of data	Any measured variable can be stored in the memory.
BACnet-IP IP configuration	Static IP / Netmask / Default gateway	Stamping format	Date (dd:MM:yy) and hour (hh:mm:ss) reference.
Port	Fixed: BAC0h	Number of events	Up to 10,000
Device object instance	0 to 9999 selectable by key-pad 0 to 2 <sup>22</sup> -2 = 4.194.302, selectable by programming software or by BACnet.	Data management type	FIFO
Supported services	"I have", "I am", "Who has", "Who is", "Read (multiple) Property"	Data stamping Type of data	Any measured variable can be stored in the memory.
Supported objects	Type 2 (analogue value, including COV property), Type 5 (binary-value for up to 16 virtual alarm re-transmission) Type 8 (device)	Stamping format	Date (dd:MM:yy) and hour (hh:mm:ss) reference.
IP configuration	Static IP / Netmask / Default gateway	Number of variables	Up to 19 different type of variables can be stored.
Modbus TCP/IP	See "Ethernet/Internet port" above	Time interval	From 1 minute up to 60 minutes.
Client connections	Modbus only: max 5 simultaneously	Data management type	FIFO
Connections	RJ45 10/100 BaseTX Max. distance 100m	Memory type	Data flash
		<b>BACnet MS/TP (on request)</b> Available ports	2: RS485 and Ethernet
		RS485 port Type	Multidrop, mono-directional (dynamic variables)
		Connections	2-wire Max. distance 1000m, termination directly on the module
		Device object instance	0 to 9999 selectable by key-pad
			0 to 2 <sup>22</sup> -2 = 4.194.302, selectable by means of programming software or by BACnet.
		Protocol	BACnet MS/TP (for measurement reading purpose and to write object description)
		Supported services	"I have", "I am", "Who has",





## Output specifications (cont.)

Supported objects	“Who is”, “Read (multiple Property)” Type 2 (analogue value, including COV property), Type 5 (binary-value for up to 16 virtual alarm re-transmission) Type 8 (device)	Note	With the rotary switch (on the back of the basic unit) in lock position the modification of the programming parameters and the reset command by means of the serial communication is not allowed. In this case just the data reading is allowed. See “Insulation between inputs and outputs” table BTL
Data (mono-directional) Dynamic	System and phase variables: see table “List of variables...”	Insulation	
Static	Not available	Approval	
Data format	1 start bit, 8 data bit, no parity, 1 stop bit	<b>Ethernet/IP (on request)</b>	
Baud-rate	Selectable: 9.6k, 19.2k, 38.4k kbit/s	Protocols	Ethernet/IP (for measurement reading purpose) and Modbus TCP/IP (for programming parameter purpose)
Driver input capability	1/5 unit load. Maximum 160 transceivers on the same bus.	IP configuration	Static IP / Netmask / Default gateway
MAC addresses	Selectable: 0 to 127	Modbus Port	Selectable (default 502)
Ethernet port Protocol	Modbus TCP/IP (for programming parameter purpose)	Ethernet/IP port Topology	Star RJ45 standard Max distance 100m
IP configuration	Static IP / Netmask / Default gateway	Level Connection	Commercial level Connection establishment: target
Modbus Port	Selectable (default 502)	Messaging	Class 1 and class 3 messaging
Client connections	Modbus only: max 5 simultaneously	Supported features	ACD (Address Conflict Detection) UCMM List service 0x0004 List identity 0x0063 Register session 0x0065 Unregister session 0x0066 Send RR data 0x006F Send Unit Data 0x0070
Connections	RJ45 10/100 BaseTX Max. distance 100m	Data	
Data		Dynamic (reading only)	System and phase variables (Ethernet/IP): see Ethernet/IP protocol document
Dynamic (reading only)	System and phase variables: see table “List of variables...”	Static (reading and writing only)	All the configuration parameters (Modbus TCP only)
Static (reading and writing only)	All the configuration parameters (Modbus only).	<b>Ethernet/IP + event recording memory</b>	
Bacnet MS/TP + event recording memory		Event stamping	
Event stamping		Type of data	Alarm, min, max, digital input status, digital output status as remote control, resets.
Type of data	Alarm, min, max, digital input status, digital output status as remote control, resets.		
Stamping format	Date (dd:MM:yy) and hour (hh:mm:ss) reference.		
Number of events	Up to 10,000		
Data management type	FIFO		
Data stamping			
Type of data	Any measured variable can be stored in the memory.		
Stamping format	Date (dd:MM:yy) and hour (hh:mm:ss) reference.		
Number of variables	Up to 19 different type of variables can be stored.		
Time interval	From 1 minute up to 60 minutes.		
Data management type	FIFO		
Memory type	Data flash		

## Output specifications (cont.)

Stamping format	Date (dd:MM:yy) and hour (hh:mm:ss) reference.	Insulation	See "Insulation between inputs and outputs" table	
Number of events	Up to 10,000			
Data management type	FIFO			
Data stamping	Any measured variable can be stored in the memory.			
Type of data				
Stamping format				Date (dd:MM:yy) and hour (hh:mm:ss) reference.
Number of variables	Up to 19 different type of variables can be stored.			
Time interval	From 1 minute up to 60 minutes.			
Data management type	FIFO			
Memory type	Data flash			
Insulation	See "Insulation between inputs and outputs" table	Module with data stamping and event recording memory (MCPBM)	Alarm, min, max, digital input status, digital output status as remote control, resets. Date (dd:MM:yy) and hour (hh:mm:ss) reference. Up to 10,000 FIFO  Any measured variable can be stored in the memory. Date (dd:MM:yy) and hour (hh:mm:ss) reference. Up to 19 different type of variables can be stored. From 1 minute up to 60 minutes. FIFO Data flash	
Approval	Ethernet/IP conformance tested (ODVA)			
<b>Profibus (MCPB)</b>	2: USB and Profibus DP V0			
Available ports				
USB				
Purpose				Programmable parameters setting
Connector				USB micro B
Protocol				Modbus RTU
Data format				1 start bit, 8 data bit, no parity, 1 stop bit
Baudrate				autorange depending on the master (max 115200 bps)
Address		1		
Profibus		Data reading (12 programmable profiles realtime selectable) ; remote output control ; remote tariff control ; output up to 4 bytes, input up to 62 words totalizers : FLOAT or INT32; electrical variables : FLOAT or INT16 ; status variables : UINT16 RS485 DB9 Profibus DP V0 slave 9.6 k to 12 Mbps (9.6, 19.2, 45.45, 93.75, 187.5, or 500 kbps; 1.5, 3, 6, or 12 Mbps) 2-125 (default 126) With the rotary switch (on the back of the basic unit) in lock position the modification of the programming parameters and the reset command by means of the serial communication is not allowed. In this case just the data reading is allowed.		
Purpose				
Modules Selectable:				
Data format				
Connector				
Protocol				
Baudrate				
Address				
Note				
			Event stamping	Date (dd:MM:yy) and hour (hh:mm:ss) reference. Up to 10,000 FIFO  Any measured variable can be stored in the memory. Date (dd:MM:yy) and hour (hh:mm:ss) reference. Up to 19 different type of variables can be stored. From 1 minute up to 60 minutes. FIFO Data flash
		Type of data		
		Stamping format		
		Number of events		
		Data management type		
		Data stamping		
		Type of data		
		Stamping format		
		Number of variables		
		Time interval		
		Data management type		
		Memory type		
		<b>Relay Output and Digital Input (M F I6 R4 on request)</b>	4 (max. 1 module per instrument) For either pulse output or alarm output Relay, SPST type AC 1-5A @ 250VAC; AC 15-1A @ 250VAC Only by means of the programming software WM3040Soft. In this latter case using either the serial communication port or the front optical port. The outputs can work as advanced alarm outputs and as remote controlled outputs, or in any other combination. Up alarm, down and window alarm. There is also the possibility to remote the control of the outputs: the activation of the outputs is managed through the serial communication port (in this case the local alarms are disabled). "OR" or "AND" or "OR+AND" functions (see "Alarm parameter and logic" page). Freely programmable on up to 16 alarms.	
		<b>Relay Outputs</b>		
		Physical outputs		
		Purpose		
		Type		
		Configuration		
		Function		
		Standard alarm modes		
		Advanced alarm modes		

## Output specifications (cont.)

Controlled variables	The alarms can be connected to any variable available in the table "List of the variables that can be connected to"	heating meters (3 choices only). • Remote alarm reset. • Trip counter of installation protection. • Direct measurements for the power quality analysis (LV or MV/HV connection); • Indirect energy and power measurements by means of external energy meters (LV or MV/HV connection); • Direct measurements for the instantaneous variables (LV connection) and indirect measurements for the energy variables (LV or MV/HV). By means of opto-mos See "Insulation between inputs and outputs" table.
Set-point adjustment	From 0 to 100% of the display scale	
Hysteresis	From 0 to full scale	
On-time delay	0 to 255s	
Output status	Selectable: normally de-energized or normally energized	
Min. response time	≤200ms, filters excluded. Set-point on-time delay: "0 s".	
<b>Digital inputs</b>		
Number of inputs	6 (voltage-free contacts)	<b>Insulation</b>  <b>Opto-mos Output and Digital Input (M F I6 O6 on request)</b> <b>Static Outputs</b> Physical outputs Purpose Type of outputs Signal Function  Signal retransmission  Pulse type  Pulse duration  <b>Advanced tariff management</b> No. of tariffs No. of total energies Data format  <b>Digital inputs</b> Number of inputs Purpose
Purpose	6 (voltage-free contacts) Contact status reading. "dmd" measurements synchronisation and clock synchronisation. Energy tariff selection. Utility meter counters. Trip counter. Interfacing with external energy meters (+kWh, +kvarh, -kWh, -kvarh). 20Hz max, duty cycle 50% From 0.1 to 999.9 m <sup>3</sup> or kWh/pulse	
Input frequency	20Hz max, duty cycle 50%	
Prescaler adjustment	From 0.1 to 999.9 m <sup>3</sup> or kWh/pulse	
Open Contact voltage	≤3.3VDC	
Closed Contact current	<1mADC	
Contact resistance	≤300Ω closed contact ≥50kΩ open contact	
Input voltage	0 to 0.5VDC: LOW 2.4 to 25VDC: HIGH	
<b>Working mode</b>	<ul style="list-style-type: none"> <li>• Total and partial energy meters (kWh and kvarh) without digital inputs;</li> <li>• Total and partial energy meters (kWh and kvarh) managed by time periods (t1-t2-t3-t4-t5-t6), W dmd synchronisation (the synchronisation is made every time the tariff changes) and GAS (m<sup>3</sup>) or WATER (hot/cold/m<sup>3</sup>) or remote heating (kWh) meters;</li> <li>• Total and partial energy meters (kWh and kvarh) managed by time periods (t1-t2), W dmd synchronisation (the synchronisation is made independently of the tariff selection) and GAS (m<sup>3</sup>) or WATER (hot/cold/m<sup>3</sup>) or remote heating (kWh) meters;</li> <li>• Total energy (kWh, kvarh) and GAS, WATER (hot-cold m<sup>3</sup>) and remote</li> </ul>	
		Up to 6 Up to 4 (+kWh, -kWh, +kvarh, -kvarh) 9-DGT for Total and partial/tariff, gas and water metering.
		6 (voltage-free contacts) Contact status reading.

## Output specifications (cont.)

<p>Input frequency Prescaler adjustment</p> <p>Open Contact voltage Closed Contact current Contact resistance</p> <p>Input voltage</p>	<p>“dmd” measurements synchronisation and clock synchronisation. Energy tariff selection. Utility meter counters. Trip counter. Remote input. Interfacing with external energy meters (+kWh, +kvarh, -kWh, -kvarh). 20Hz max, duty cycle 50% From 0.1 to 999.9 m<sup>3</sup> or kWh/pulse ≤3.3VDC &lt;1mADC ≤300Ω closed contact ≥50kΩ open contact 0 to 0.5VDC LOW 2.4 to 25VDC HIGH</p>	<p>Insulation</p>	<p>indirect measurements by external energy meters (LV or MV/HV). By means of opto-mos See “Insulation between inputs and outputs” table.</p>
<p><b>Working mode</b></p>	<ul style="list-style-type: none"> <li>• Total and partial energy meters (kWh and kvarh) without digital inputs;</li> <li>• Total and partial energy meters (kWh and kvarh) managed by time periods (t1-t2-t3-t4-t5-t6), W dmd synchronisation (the synchronisation is made every time the tariff changes) and GAS (m<sup>3</sup>) or WATER (hot/cold/m<sup>3</sup>) or remote heating (kWh) meters;</li> <li>• Total and partial energy meters (kWh and kvarh) managed by time periods (t1-t2), W dmd synchronisation (the synchronisation is made independently of the tariff selection) and GAS (m<sup>3</sup>) or WATER (hot/cold/m<sup>3</sup>) or remote heating (kWh) meters;</li> <li>• Total energy (kWh, kvarh) and GAS, WATER (hot-cold m<sup>3</sup>) and remote heating meters (3 choices only).</li> <li>• Remote alarm reset.</li> <li>• Remote input channel status.</li> <li>• Trip counter of installation protection.</li> <li>• Direct measurements for the power quality analysis (LV or MV/HV connection);</li> <li>• Indirect energy and power measurements by means of watt-hour meters (LV or MV/HV connection);</li> <li>• Direct measurements for the instantaneous variables (LV connection) and</li> </ul>	<p><b>Temperature and Process signal inputs (M A T P on request)</b></p> <p>Temperature signal Number of inputs Accuracy (Display + RS485)</p> <p>Temperature drift Temperature probe Number of wires Wire compensation Engineering unit</p> <p>Process signal Number of inputs Accuracy (Display + RS485)</p> <p>Temperature drift Process signal input Signal overload</p> <p>Input impedance Min. and Max. indication</p> <p>Module with true neutral current input (M A T P N) Accuracy (Display + RS485)</p> <p>Temperature drift Measuring input type</p> <p>Transformer ratio</p> <p>Crest factor Current Overloads Continuous For 500ms Input impedance Frequency</p>	<p>1 See table “Temperature input characteristics” ≤150ppm/°C Pt100, Pt1000 2 or 3-wire connection Up to 10Ω Selectable °C o °F</p> <p>1 ±(0,2%RDG+2DGT) da 0% a 25% FS; ±(0,1%RDG+2DGT) da 25% a 110% FS. ≤150ppm/°C -20mA to +20mADC Continuous: 50mADC For 1 s.: 150mADC &lt;12Ω -9999 to +9999 fully programmable scaling with decimal point positioning.</p> <p>In: 1A From 0.01In to 0.05In: ±(0,5% RDG +2DGT) From 0.05In to 1.2In: ±(0,2% RDG +2DGT) ≤150ppm/°C To be connected to external current transformer Up to 10kA (CT ratio 9999 max) ≤3 (3A max. peak)</p> <p>1.2A, @ 50Hz 10A, @ 50Hz 0.5Ω 45 to 65 Hz</p>



## Temperature input characteristics

Probe	Range	Accuracy	Min Indication	Max Indication
Pt100	-60.0°C to +300.0°C	±(0.5%RDG +5DGT)	- 60.0	+ 300.0
Pt100	-76°F to +572°F	±(0.5%RDG +5DGT)	- 76.0	+ 572.0
Pt1000	-60.0°C to +300.0°C	±(0.5%RDG +5DGT)	- 60.0	+ 300.0
Pt1000	-76°F to +572°F	±(0.5%RDG +5DGT)	- 76.0	+ 572.0

## Tariff energy meters and time period management

**NOTE:** only in case of M F I6 R4 and M F I6 O6 modules.

<b>Meters</b>			
Total	4 (up to 10 digit)	"Holiday Period" energy meters	Up to 10 ("H1 ... H10"). As per standard period management every single one can be set by day/month/year.
Partial	72 (up to 10 digit)		
<b>Tariffs</b>	Up to 6		
<b>Time periods</b>	Up to 3 year	"Tariff" energy meters	Up to 6 per period (P1/ P2 and H1 ... H10). Every tariff is daily based and is called "t1" ... "t6". The single tariff can be set as "Hours and minutes". Every single tariff "t" may has an independent start and stop which may be different also from period to period "P1 and P2". Every single tariff manages an independent energy meter which is split according the measured energy in: +kWh, -kWh, +kvarh.
<b>Pulse output</b>	Connectable to total and/or partial meters		
<b>Storage</b>	Consumption history by storing the monthly energy meters (12 previous months) into the EEPROM. Storage of total and partial energy meters. Energy meter storage format (EEPROM) Min. -9,999,999,999 kWh/kvarh Max. 9,999,999,999 kWh/kvarh		
<b>Energy Meters</b>			
"Total" energy meters	Base on digital inputs and clock management +kWh, +kvarh, -kWh, -kvarh.	Partial energy meters	+kWh, +kvarh, -kWh, -kvarh (basic unit without any module)
"Standard Period" energy meters	Up to 2 ("P1" and "P2") which can be set by month and year each.		

## Tariff energy meters overall working scheme

**NOTE:** only in case of M F I6 R4 and M F I6 O6 modules.

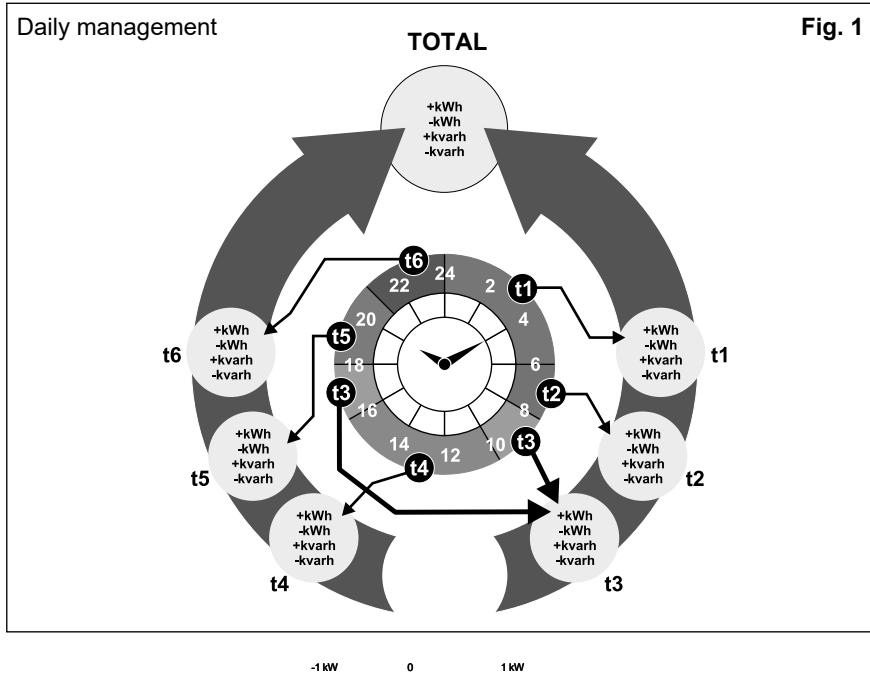

Where t1 to t6 are the "Tariffs".

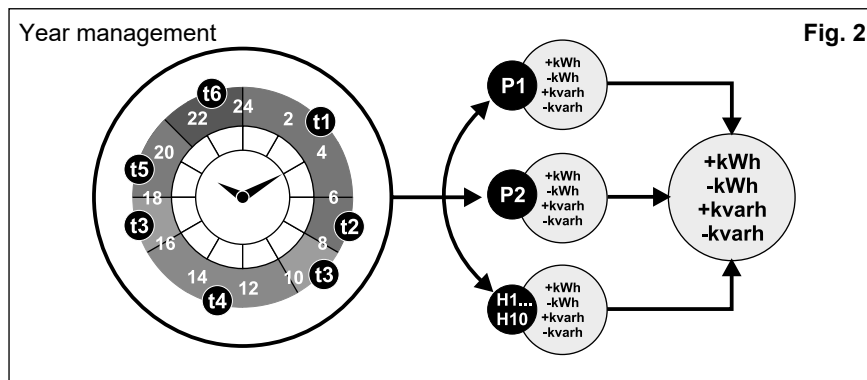

Where P1 and P2 are the "Standard Periods" and H1 ... H10 Holiday periods which are identified by a defined day (non working day), by a vacation period or by a season period.

**Note:** the displaying of every single energy tariff is relevant only to the period being used. Other periods are available through the communication port.

## Energy meters

<b>Meters</b>	
Total	4 (10 digit)
Partial	4 (10 digit)
<b>Pulse output</b>	Connectable to total and/or partial meters
<b>Energy meter recording</b>	Storage of total and partial energy meters. Energy meter storage format (EEPROM) Min. -9,999,999,999.9 kWh/kvarh Max. 9,999,999,999.9 kWh/kvarh.

### Energy Meters

Total energy meters

Partial energy meters

+kWh, +kvarh, -kWh, -kvarh  
+kWh, +kvarh, -kWh, -kvarh



## Management of the digital inputs

**NOTE:** only in case of M F I6 R4 and M F I6 O6 modules.

Function	Note	Digital inputs					
		1	2	3	4	5	6
Synch (dmd)	(1)	YES					
Tariff change	(2)	YES	YES	YES			
Hot Water	(3)				YES	YES	YES
Cold Water	(3)				YES	YES	YES
Gas	(3)				YES	YES	YES
Remote heating	(3)				YES	YES	YES
Remote alarm reset	(4)				YES		
Trip counter of protection	(5)				YES		
Remote input channel status	(6)	YES	YES	YES	YES	YES	YES
kWh counting (-)	(7)			YES			
kWh counting (+)	(7)				YES		
kvarh counting (+)	(7)					YES	

**Note:** every single digital input can be configured according to the table above.

(1) At each status change of digital signal (from OFF to ON) the instrument synchronises the DMD calculation. It also synchronises the clock to the multiple of the integration time nearest to the current time.

(2) It is used to select by means of the logic of three inputs up to 6 different tariffs: t1-t2-t3-t4-t5-t6. Every time the tariff changes, it starts also the synchronisation of the “dmd” calculation.

(3) It is used to count the pulses coming from different Utility meters like: cold water, hot water, gas and remote heating.

(4) It is used to remotely reset the alarms (In case of latch alarm).

(5) It is used to count how many times an external protection device trips.

(6) This function is available only in case of serial communication. It allows to detect the status of the digital input. The status is displayed on the display as well.

(7) The energy is metered by means of pulses coming from a external energy meter. This meter can be provided with up to 3 outputs (for imported active and reactive energy and for exported active energy). Note: the pulses counted from the watt-hour meter replaces the standard measurement of energy and the relevant displaying (total, partial and tariff), all other measurements (eg: V-A-W-VA-var, THD and so on) are still performed and displayed.

## Harmonic distortion analysis

<b>Analysis principle</b>	FFT	<b>Harmonic phase angle</b>	The instrument measures the angle between the single harmonic of “V” and the single harmonic of “I” of the same order. According to the value of the electrical angle, it is possible to know if the distortion is absorbed or generated. Note: if the system has 3 wires without neutral the angle cannot be measured.
<b>Harmonic measurement</b> Current Voltage	Up to the 32nd harmonic Up to the 32nd harmonic		
<b>Type of harmonics</b>	THD (VL1 and VL1-N) THD odd (VL1 and VL1-N) THD even (VL1 and VL1-N) TDD The same for the other phases: L2, L3. THD (AL1) THD odd (AL1) THD even (AL1) The same for the other phases: L2, L3.	<b>Harmonic details</b>	The harmonic spectrum so to built-up a graph is available only by means of the serial communication.

## Event logging, data logging and load profiling

**NOTE:** only in case of M C 485 232 M, M C ETH M, M C BAC IP M, M C BAC MS M and M C EI M modules

<p><b>Event logging</b></p> <p>Data displaying</p> <p>Function enabling Stored data type Number of events Data reset</p> <p>Data format</p> <p>Storage method FIFO Memory type Memory retention time</p>	<p>Only with communication module provided with data memory.</p> <p>The data are available on the display limited to the last 99 events. All events can be both checked and downloaded using any available communication port in combination with WM3040Soft software.</p> <p>Activation: NO/YES Alarms, max./min. Max. 10,000</p> <p>All events can be reset manually</p> <p>Event, date (dd:mm:yy) and time (hh:mm:ss)</p> <p>Flash 10 years</p>	<p>Storage duration</p> <p>Number of variables</p> <p>Data format</p> <p>Storage method FIFO Memory type Memory size Memory retention time</p>	<p>Before overwriting, see "Historical data storing time table".</p> <p>See "Historical data storing time table".</p> <p>Variable, date (dd:mm:yy) and time (hh:mm:ss)</p> <p>Flash 4Mb 10 years</p>
<p><b>Data logging</b></p> <p>Data displaying</p> <p>Function enabling Stored data type Storage interval</p> <p>Sampling management</p>	<p>Only with communication module provided with data memory.</p> <p>The data are not available on the display but they can be both checked and downloaded using any available communication port in combination with WM3040Soft software.</p> <p>Activation: NO/YES All variables. Programmable from 1 min. to 60 min.; all instantaneous variables can be selected (max 19 variables)</p> <p>The sample stored within the selected time interval results from the continuous average of the measured values. The average is calculated (min. sample) with an interval within two following measurements of approx. 100 ms.</p>	<p><b>Load profiling</b></p> <p>Data displaying</p> <p>Function enabling Storage interval</p> <p>Storage duration</p> <p>Data format</p> <p>Data synchronisation Other characteristics</p>	<p>Only with communication module provided with data memory.</p> <p>The data are not available on the display but they can be both checked and downloaded using any available communication port in combination with WM3040Soft software.</p> <p>Activation: NO/YES Selectable: 5-10-15-20-30-60 minutes of Wdmd and VAdmd.</p> <p>Before overwriting, 100 weeks: with recording interval of 5min; 300 weeks: with storing interval of 15min.</p> <p>Wdmd variable value, minutes, day, month. Based on internal clock As per Event and Data logging.</p>

## Display, LED's and commands

<b>Display refresh time</b>	≤ 250 ms	Virtual alarms	4 red LED available in case of virtual alarm (ALG1-AL G2-AL G3-AL G4), every LED groups 4 alarms. Note: the real alarm is just the activation of the proper static or relay output if the proper module is available. Red LED (only kWh) 0.001 kWh/kvarh by pulse if the Ct ratio by VT ratio is ≤7 0.01 kWh/kvarh by pulse if the Ct ratio by VT ratio is ≥7.1 ≤70.0 0.1 kWh/kvarh by pulse if the Ct ratio by VT ratio is ≥70.1 ≤700.0 1 kWh/kvarh by pulse if the Ct ratio by VT ratio is ≥700.1 ≤7000 10 kWh/kvarh by pulse if the Ct ratio by VT ratio is ≥7001 ≤70.00k 100 kWh/kvarh by pulse if the Ct ratio by VT ratio is >70.01k Max frequency: 16Hz, according to EN50470-1
<b>Display</b>	4 lines, 4-DGT, 1 lines, 10-DGT	Energy consumption kWh pulsating	
Type	LCD, dual colour backlight (selectable)		
Digit dimensions	4-DGT: h 11 mm; 10-DGT: h 7 mm		
Instantaneous variables read-out	4-DGT		
Energies variables read-out	Imported Total/Partial/Tariff: 8+2DGT, 9+1DGT or 10DGT; Exported Total/Partial/ Tariff: 8+2DGT, 9+1DGT or 10DGT (with “-“ sign).		
Gas-water-remote heating read-out	8+2DGT, 9+1DGT or 10DGT		
Run Hours counter	8+2 DGT (99.999.999 hours and 59 minutes max)		
Overload status	EEEE indication when the value being measured is exceeding the “Continuous inputs overload” (maximum measurement capacity)		
Max. and Min. indication	Max. instantaneous variables: 9999; energies: 9 999 999 999. Min. instantaneous variables: 0.000; energies 0.0		
<b>Front position LEDs</b>		<b>Back position LEDs</b>	
Bar-graph	Three groups of 3-LED (green-red) split by phase L1-L2-L3 and level of measurement. The full scale (100%) is referred to a programmable value which is corresponding to the variable being measured and displayed by the instrument at the time.	On the base	Green as power-on
		On the communication modules	Two LEDs: one for TX (green) and one for RX (amber).
		<b>Key-pad</b>	For variable selection, programming of the instrument working parameters reset, “dmd”, “max”, total energy and partial energy and event.

## Main functions

<b>Password</b>	Numeric code of max. 4 digits; 2 protection levels of the programming data: Password “0”, no protection; Password from 1 to 9999, all data are protected	System 3-Ph.1 balanced load	and 3-phase to phase voltage measurements. 3-phase (3-wire), one current and 3-phase to phase voltage measurements 3-phase (4-wire), one current and 3-phase to neutral voltage measurements.
1st level			
2nd level			
<b>System selection</b>		System 3-Ph.2 balanced load	3-phase (2-wire), one current and 1-phase (L1) to neutral voltage measurement.
System 3-Ph.n unbalanced load	3-phase (4-wire)	System 2-Ph	2-phase (3-wire)
System 3-Ph. unbalanced load	3-phase (3-wire), three currents and 3-phase to phase voltage measurements, or in case of Aaron connection two currents (with special wiring on screw terminals)	System 1-Ph	1-phase (2-wire)

## Main functions (cont.)

<b>Transformer ratio</b> VT (PT)  CT	1.0 to 999.9 / 1000 to 9999.  1.0 to 999.9 / 1000 to 9999 (up to 10kA in case of CT with 1A secondary current and up to 50kA in case of CT with 5A secondary current).		details see "Working mode of the display in a normal/ abnormal condition")
<b>Filter</b> Operating range  Filtering coefficient Filter action	Selectable from 0 to 100% of the input display scale Selectable from 1 to 32 Measurements, analogue signal retransmission, serial communication (fundamental variables: V, A, W and their derived ones).	<b>Reset</b>	By means of the front key- pad or the configuration software. It is possible to reset the following data: - all the min, max, dmd, and dmd-max values. - total energies: kWh, kvarh; - partial energies and tariffs: kWh, kvarh; - gas, water and remote heating; - latch alarms; - all the events; - all the load profiling; - all data logging
<b>Displaying</b> Number of variables          Backlight      The backlight time is programmable from 0 (always on) to 255 minutes	Up to 5 variables per page. See "Front view". Many different set of variables available (see "Display pages") according to the application being selected. One page is freely programmable as combination of variables.	<b>Harmonic analysis</b>	Up to the 32nd harmonics on current and voltage including also "odd" and "even" THD. In case of communication module availability (any type) every single information is available in the communication protocol.
<b>Virtual alarms</b> Working condition  No. of alarms Working mode          Controlled variables       Set-point adjustment  Hysteresis On-time delay Min. response time	In case of basic unit or with the addition of M O R2 or M O O2. Up to 16 Up alarm and down alarm and windows alarm (IN/ OUT). The alarms can be connected to any instantaneous variable available in the table "List of the variables that can be connected to". From 0 to 100% of the display scale From 0 to 100% 0 to 255s ≤ 200ms, filters excluded. Set-point on-time delay: "0 s".	<b>Clock</b> Functions Time format       Date format       Battery life	Universal clock and calendar. Hour: minutes: seconds with selectable 24H or 12H AM/PM format. Day-month-year with selectable DD-MM-YY or MM-DD-YY format. 10 years
<b>Alarm highlight</b>	In case of alarm and if the relevant function is enabled, the display changes the colour from white backlight to blue backlight or to another available colour combination (fore more	<b>Easy programming function</b>	For all the display selections, both energy and power measurements are independent from the current direction. The displayed energy is always "imported" with the only exception of "C", "D", "E" and "G" types (see "display pages" table). For those latter selections the energies can be either "imported" or "exported" depending on the current direction.

## General specifications

<b>Operating temperature</b>	-25°C to +55°C (-13°F to 131°F) (R.H. from 0 to 90% non-condensing @ 40°C) according to EN62053-21, EN50470-1 and EN62053-23	<b>Standard compliance</b>	
<b>Storage temperature</b>	-30°C to +70°C (-22°F to 158°F) (R.H. < 90% non-condensing @ 40°C) according to EN62053-21, EN50470-1 and EN62053-23	<b>Safety</b>	IEC60664, IEC61010-1 EN60664, EN61010-1 EN62052-11.
<b>Installation category</b>	Cat. III (IEC60664, EN60664)	<b>Metrology</b>	EN62053-22, EN62053-23, EN50470-3.
<b>Insulation (for 1 minute)</b>	See "Insulation between inputs and outputs" table	<b>Pulse output</b>	DIN43864, IEC62053-31
<b>Dielectric strength</b>	4kVAC RMS for 1 minute	<b>Approvals</b>	CE, cULus "Listed" (cULus: max. 40°C, all modules in all combinations)
<b>Noise rejection CMRR</b>	100 dB, 48 to 62 Hz	<b>Connections</b>	Screw-type max. 2.5 mm <sup>2</sup> . min./max. screws tightening torque: 0.4 Nm / 0.8 Nm. Suggested screws tightening torque: 0.5 Nm
<b>EMC</b>	According to EN62052-11	<b>Housing</b>	
Electrostatic discharges	15kV air discharge	<b>Dimensions (WxHxD)</b>	Module holder: 96x96x50mm. "A" and "B" type modules: 89.5x63x16mm. "C" type module: 89.5x63x20mm.
Immunity to irradiated	Test with current: 10V/m from 80 to 2000MHz	<b>Max. depth behind the panel</b>	With 3 modules (A+B+C): 81.7 mm
Electromagnetic fields	Test without any current: 30V/m from 80 to 2000MHz	<b>Material</b>	ABS/Nylon PA66, self-extinguishing: UL 94 V-0
Burst	On current and voltage measuring inputs circuit: 4kV	<b>Mounting</b>	Panel mounting
Immunity to conducted disturbances	10V/m from 150KHz to 80MHz	<b>Protection degree</b>	
Surge	On current and voltage measuring inputs circuit: 4kV; on "L" auxiliary power supply input: 1kV	<b>Front</b>	IP65, NEMA4x, NEM12
Radio frequency suppression	According to CISPR 22	<b>Screw terminals</b>	IP20
		<b>Weight</b>	Approx. 420 g (packing included)

## Power supply specifications

<b>Auxiliary power supply</b>	H: 100-240 +/-10% (90 to 255) VDC/AC (50/60 Hz) L: 24-48 +/-15% (20 to 55) VDC/AC (50/60 Hz)	<b>Power consumption</b>	AC: 20 VA; DC: 10 W
<b>Auxiliary power supply according to UL</b>	100 to 240VAC +10% -15% 100 to 240VDC +10% -20% 24 to 48VAC +10% -15% 24 to 48VDC +10% -20%		

## Insulation between inputs and outputs

	Power Supply	Measuring Input	Relay outputs (MOR2)	Relay outputs (MFR4I6)	Static outputs (MOO2)	Static outputs (MFO6I6)	Serial communication	Ethernet port	Analogue output	Digital inputs	Neutral current input	20mA input	Temperature input
Power Supply	-	4kV	4kV	4kV	4kV	4kV	4kV	4kV	4kV	4kV	4kV	4kV	4kV
Measuring Input	4kV	-	4kV	4kV	4kV	4kV	4kV	4kV	4kV	4kV	4kV	4kV	4kV
Relay outputs (MOR2)	4kV	4kV	2kV	4kV	-	4kV	4kV	4kV	4kV	4kV	4kV	4kV	4kV
Relay outputs (MFR4I6)	4kV	4kV	4kV	2kV	4kV	-	4kV	4kV	4kV	4kV	4kV	4kV	4kV
Static outputs (MOO2)	4kV	4kV	-	4kV	2kV	4kV	4kV	4kV	4kV	4kV	4kV	4kV	4kV
Static outputs (MFO6I6)	4kV	4kV	4kV	-	4kV	0kV	4kV	4kV	4kV	4kV	4kV	4kV	4kV
Serial communication	4kV	4kV	4kV	4kV	4kV	4kV	-	-	4kV	4kV	4kV	4kV	4kV
Ethernet port	4kV	4kV	4kV	4kV	4kV	4kV	-	-	4kV	4kV	4kV	4kV	4kV
Analogue output	4kV	4kV	4kV	4kV	4kV	4kV	4kV	4kV	4kV*	4kV	4kV	4kV	4kV
Digital inputs	4kV	4kV	4kV	4kV	4kV	4kV	4kV	4kV	4kV	0kV	4kV	4kV	4kV
Neutral current input	4kV	4kV	4kV	4kV	4kV	4kV	4kV	4kV	4kV	4kV	-	0kV	0kV
20mA input	4kV	4kV	4kV	4kV	4kV	4kV	4kV	4kV	4kV	4kV	0kV	-	0kV
Temperature input	4kV	4kV	4kV	4kV	4kV	4kV	4kV	4kV	4kV	4kV	0kV	0kV	-

\*: 4kV respect another module 4kV, in the same module 0kV.

0kV: not isolated.

-: combination not allowed.

**NOTE:** all the models have, mandatory, to be connected to external current transformers because the isolation among the current inputs is just functional (100VAC).



## List of the variables that can be connected to:

- Communication port (all listed variables)
- Analogue outputs (all variables with the only exclusion of “totalizers” and “run hour counter”)
- Pulse outputs (only “energies”)
- Alarm outputs (“totalizers”, “hour counter” and “max” excluded)

No.	Variable	1-ph. sys	2-ph. sys	3-ph. 3/4-wire balanced sys	3-ph. 2-wire balanced sys	3-ph. 3-wire unbal. sys	3-ph. 4-wire unbal. sys	Notes
1	VL-N sys	O	X	X	X	#	X	sys= system= $\sum$ (1)(2)(3)
2	VL1	X	X	X	X	#	X	(1)(2)(3)
3	VL2	O	X	H	H	#	X	(1)(2)(3), (H)=VL1
4	VL3	O	O	H	H	#	X	(1)(2)(3), (H)=VL1
5	VL-L sys	#	#	X	X	X	X	sys= system= $\sum$ (1)
6	VL1-2	#	X	X	P	X	X	(1)(2)(3), (P)=VL1*1.73
7	VL2-3	#	O	X	P	X	X	(1)(2)(3), (P)=VL1*1.73
8	VL3-1	#	O	X	P	X	X	(1)(2)(3), (P)=VL1*1.73
9	Asys	O	X	O	O	X	X	
10	An	#	X	O	O	O	X	
11	AL1	X	X	X	X	X	X	(1)(2)(3)
12	AL2	O	X	R	R	X	X	(1)(2)(3), (R)=AL1
13	AL3	O	O	R	R	X	X	(1)(2)(3), (R)=AL1
14	VA sys	O	X	X	X	X	X	sys= system= $\sum$ (1)(2)(3)
15	VA L1	X	X	X	X	#	X	(1)(2)(3)
16	VA L2	O	X	U	U	#	X	(1)(2)(3) U=VAL1
17	VA L3	O	O	U	U	#	X	(1)(2)(3) U=VAL1
18	var sys	O	X	X	X	X	X	sys= system= $\sum$ (1)(2)(3)
19	var L1	X	X	X	X	#	X	(1)(2)(3)
20	var L2	O	X	V	V	#	X	(1)(2)(3) V=VARL1
21	var L3	O	O	V	V	#	X	(1)(2)(3) V=VARL1
22	W sys	O	X	X	X	X	X	sys= system= $\sum$ (1)(2)(3)
23	WL1	X	X	X	X	#	X	(1)(2)(3)
24	WL2	O	X	S	S	#	X	(1)(2)(3), (S)=WL1
25	WL3	O	O	S	S	#	X	(1)(2)(3), (S)=WL1
26	PF sys	O	X	X	X	X	X	sys= system= $\sum$ (1)
27	PF L1	X	X	X	X	#	X	(1)(2)(3)
28	PF L2	O	X	T	T	#	X	(1)(2)(3), (T)=PFL1
29	PF L3	O	O	T	T	#	X	(1)(2)(3), (T)=PFL1
30	Hz	X	X	X	X	X	X	(1)(2)(3)
31	Phase seq.	O	O	X	O	X	X	

(X) = available; (O) = not available (variable not available on the display); (#) Not available (the relevant page is not displayed)

(1) Min. and Max. and average value with data storage; (2) “dmd” calculation and data storage; (3) “dmd-max” calculation and data storage; (5) On 4 quadrants (ind/cap); (6) C1, C2 and C3 may be set as either cold water, hot water, remote heating or gas depending on the input configuration.

## List of the variables that can be connected to (cont.):

- Communication port (all listed variables)
- Analogue outputs (all variables with the only exclusion of “energies” and “run hour counter”)
- Pulse outputs (only “energies”)
- Alarm outputs (“energies”, “hour counter” and “max” excluded)

No.	Variable	1-ph. sys	2-ph. sys	3-ph. 3/4-wire balanced sys	3-ph. 2-wire balanced sys	3-ph. 3-wire unbal. sys	3-ph. 4-wire unbal. sys	Notes
32	Asy VLL	O	X	X	O	X	X	Asymmetry
33	Asy VLN	O	X	#	O	#	X	Asymmetry
34	Run Hours	X	X	X	X	X	X	
35	kWh (+)	X	X	X	X	X	X	Total
36	kvarh (+)	X	X	X	X	X	X	Total (5)
37	kWh (+)	X	X	X	X	X	X	Partial or by tariff
38	kvarh (+)	X	X	X	X	X	X	Partial or by tariff (5)
39	kWh (-)	X	X	X	X	X	X	Total
40	kvarh (-)	X	X	X	X	X	X	Total (5)
41	kWh (-)	X	X	X	X	X	X	Partial
42	kvarh (-)	X	X	X	X	X	X	Partial (5)
43	C1 (input 4)	X	X	X	X	X	X	Total (6)
44	C2 (input 5)	X	X	X	X	X	X	Total (6)
45	C3 (input 6)	X	X	X	X	X	X	Total (6)
46	Trip counter	X	X	X	X	X	X	Total
47	kWh Water	X	X	X	X	X	X	Total
48	A L1 THD	X	X	X	X	X	X	(2) (3) (4)
49	A L2 THD	O	X	F	F	X	X	(2)(3)(4), (F)=AL1THD
50	A L3 THD	O	O	F	F	X	X	(2)(3)(4), (F)=AL1THD
51	V L1 THD	X	X	X	X	#	X	(2)(3)(4)
52	V L2 THD	O	X	X	G	#	X	(2)(3)(4), (G)=VL1THD
53	V L3 THD	O	O	X	G	#	X	(2)(3)(4), (G)=VL1THD
54	V L1-2 THD	#	X	X	#	X	X	(2) (3) (4)
55	V L2-3 THD	#	O	X	#	X	X	(2) (3) (4)
56	V L3-1 THD	#	O	X	#	X	X	(2) (3) (4)
57	A L1 TDD	X	X	X	X	X	X	(2) (3) (4)
58	A L2 TDD	O	X	X	X	X	X	(2) (3) (4)
59	A L3 TDD	O	O	X	X	X	X	(2) (3) (4)
60	K-Factor	O	O	X	X	X	X	(2) (3) (4)

(X) = available; (O) = not available (variable not available on the display); (#) Not available (the relevant page is not displayed); (2) “dmd” calculation and data storage; (3) “dmd-max” calculation and data storage; (4) Odd and Even THD’s;

## List of selectable applications

	Description	Notes
<b>A</b>	Cost allocation	Imported energy metering
<b>B</b>	Cost control	Imported and partial energy metering and utilities
<b>C</b>	Complex cost allocation	Imported/exported energy (total, partial and tariff) and utilities
<b>D</b>	Solar	Imported and exported energy metering with some basic power analyzer function
<b>E</b>	Complex cost and power analysis	Imported/exported energy (total and partial) and power analysis
<b>F</b>	Cost and power quality analysis	Imported energy and power quality analysis
<b>G</b>	Advanced energy and power analysis for power generation	Complete energy metering and power quality analysis



## Display pages

No.	Line 1 Variable Type	Line 2 Variable Type	Line 3 Variable Type	Line 4 Variable Type	Line 5 Variable Type	Note	Applications						
							A	B	C	D	E	F	G
0	Total kWh (+)						x	x	x	x	x	x	x
1	Total kvarh (+)						x	x	x		x	x	x
2	Total kWh (-)								x	x	x		x
3	Total kvarh (-)								x		x		x
4	kWh (+) partial							x	x		x	x	x
5	kvarh (+) part.							x	x		x	x	x
6	kWh (-) partial								x		x		x
7	kvarh (-) part.								x		x		x
8	Run Hours (99999999.99)								x	x	x	x	x
9	kWh (+) t1								x		x		x
10	kvarh (+) t1								x		x		x
11	kWh (-) t1								x		x		x
12	kvarh (-) t1								x		x		x
13	kWh (+) t2								x		x		x
14	kvarh (+) t2								x		x		x
15	kWh (-) t2								x		x		x
16	kvarh (-) t2								x		x		x
17	kWh (+) t3								x		x		x
18	kvarh (+) t3								x		x		x
19	kWh (-) t3								x		x		x
20	kvarh (-) t3								x		x		x
21	kWh (+) t4								x		x		x
22	kvarh (+) t4								x		x		x
23	kWh (-) t4								x		x		x
24	kvarh (-) t4								x		x		x
25	kWh (+) t5								x		x		x
26	kvarh (+) t5								x		x		x
27	kWh (-) t5								x		x		x
28	kvarh (-) t5								x		x		x
29	kWh (+) t6								x		x		x
30	kvarh (+) t6								x		x		x
31	kWh (-) t6								x		x		x
32	kvarh (-) t6								x		x		x
33	C1					(5)		x	x		x		x
34	C2					(5)		x	x		x		x
35	C3					(5)		x	x		x		x
36		VLN $\Sigma$	VL1	VL2	VL3	(1) (2) (3)				x	x	x	x
37		VLL $\Sigma$	VL1-2	VL2-3	VL3-1	(1) (2) (3)				x	x	x	x
38		An	AL1	AL2	AL3	(1) (2) (3)				x	x	x	x
39		Hz	"ASY"	VLL sys (% asy)	VLN sys (% asy)	(1) (2) (3)				x	x	x	x
40		A $\Sigma$	AL1	AL2	AL3	(1) (2) (3)				x	x	x	x
41		W $\Sigma$	WL1	WL2	WL3	(1) (2) (3)				x	x	x	x
42		var $\Sigma$	var L1	var L2	var L3	(1) (2) (3)					x	x	x
43		PF $\Sigma$	PF L1	PF L2	PF L3	(1) (2) (3)					x	x	x
44		VA $\Sigma$	VA L1	VA L2	VA L3	(1) (2) (3)						x	x
45				Process sig.	Temperature	(1) (2) (3)							x
46			THD V1	THD V2	THD V3	(1) (2) (3)							x
47			THD V12	THD V23	THD V31	(1) (2) (3)							x
48			THD A1	THD A2	THD A3	(1) (2) (3)							x
49			THD V1 odd	THD V2 odd	THD V3 odd	(1) (2) (3)							x
50			THD V12 odd	THD V23 odd	THD V31 odd	(1) (2) (3)							x
51			THD A1 odd	THD A2 odd	THD A3 odd	(1) (2) (3)							x
52			THD V1 even	THD V2 even	THD V3 even	(1) (2) (3)							x
53			THD V12 even	THD V23 even	THD V31 even	(1) (2) (3)							x
54			THD A1 even	THD A2 even	THD A3 even	(1) (2) (3)							x
55			TDD A1	TDD A2	TDD A3	(1) (2) (3)							x
56			k-FACT L1	k-FACT L2	k-FACT L3	(1) (2) (3)							x

Note: the table refers to system 3P.n.

(1) Also Minimum value (no EEPROM storage). (2) Also Maximum value (no EEPROM storage). (3) Also Average (dmd) value (no EEPROM storage). (5) C1, C2 and C3 may be set as either cold water, hot water, remote heating or gas depending on the digital inputs configuration.

## Additional available information on the display

No.	8 Line 1	Line 2	Line 3	Line 4	Line 5	Applications						
						A	B	C	D	E	F	G
1	Lot n. (text) xxxx	Yr. (text) xx	rEL	X.xx	1...60 (min) "dmd"	x	x	x	x	x	x	x
2	Conn. xxx.x (3ph.n/3ph/3ph.1/ 3ph.2/1ph/2ph)	CT.rA (text)	1.0 ... 99.99k	PT.rA (text)	1.0...9999	x	x	x	x	x	x	x
3	LED PULSE (text) kWh	xxxx kWh per pulse				x	x	x	x	x	x	x
4	PULSE out1 (text) kWh/kvarh	xxxx kWh/kvarh per pulse	+/- tot/PAr/ tAr 1-2-3-4			x	x	x	x	x	x	x
5	PULSE out2 (text) kWh/kvarh	xxxx kWh/kvarh per pulse	+/- tot/PAr/ tAr 1-2-3-4			x	x	x	x	x	x	x
6	PULSE out3 (text) kWh/kvarh	xxxx kWh/kvarh per pulse	+/- tot/PAr/ tAr 1-2-3-4			x	x	x	x	x	x	x
7	PULSE out4 (text) kWh/kvarh	xxxx kWh/kvarh per pulse	+/- tot/PAr/ tAr 1-2-3-4			x	x	x	x	x	x	x
8	PULSE out5 (text) kWh/kvarh	xxxx kWh/kvarh per pulse	+/- tot/PAr/ tAr 1-2-3-4			x	x	x	x	x	x	x
9	PULSE out6 (text) kWh/kvarh	xxxx kWh/kvarh per pulse	+/- tot/PAr/ tAr 1-2-3-4			x	x	x	x	x	x	x
10	PULSE out7 (text) kWh/kvarh	xxxx kWh/kvarh per pulse	+/- tot/PAr/ tAr 1-2-3-4			x	x	x	x	x	x	x
11	PULSE out8 (text) kWh/kvarh	xxxx kWh/kvarh per pulse	+/- tot/PAr/ tAr 1-2-3-4			x	x	x	x	x	x	x
12	Remote out.	Out 1 (text)	on/oFF	Out 2 (text)	on/oFF	x	x	x	x	x	x	x
13	Remote out.	Out 3 (text)	on/oFF	Out 4 (text)	on/oFF	x	x	x	x	x	x	x
14	Remote out.	Out 5 (text)	on/oFF	Out 6 (text)	on/oFF	x	x	x	x	x	x	x
15	Remote out.	Out 7 (text)	on/oFF	Out 8 (text)	on/oFF	x	x	x	x	x	x	x
16	AL1 OUTx NE/ND	Variable link L 1/2/3	Set1	Set2	(Measurement)				x	x	x	x
17	AL2 OUTx NE/ND	Variable link L 1/2/3	Set1	Set2	(Measurement)				x	x	x	x
18	AL3 OUTx NE/ND	Variable link L 1/2/3	Set1	Set2	(Measurement)				x	x	x	x
19	AL4 OUTx NE/ND	Variable link L 1/2/3	Set1	Set2	(Measurement)				x	x	x	x
20	AL5 OUTx NE/ND	Variable link L 1/2/3	Set1	Set2	(Measurement)				x	x	x	x
21	AL6 OUTx NE/ND	Variable link L 1/2/3	Set1	Set2	(Measurement)				x	x	x	x
22	AL7 OUTx NE/ND	Variable link L 1/2/3	Set1	Set2	(Measurement)				x	x	x	x
23	AL8 OUTx NE/ND	Variable link L 1/2/3	Set1	Set2	(Measurement)				x	x	x	x
24	AL9 OUTx NE/ND	Variable link L 1/2/3	Set1	Set2	(Measurement)				x	x	x	x
25	AL10 OUTx NE/ND	Variable link L 1/2/3	Set1	Set2	(Measurement)				x	x	x	x
26	AL11 OUTx NE/ND	Variable link L 1/2/3	Set1	Set2	(Measurement)				x	x	x	x
27	AL12 OUTx NE/ND	Variable link L 1/2/3	Set1	Set2	(Measurement)				x	x	x	x
28	AL13 OUTx NE/ND	Variable link L 1/2/3	Set1	Set2	(Measurement)				x	x	x	x
29	AL14 OUTx NE/ND	Variable link L 1/2/3	Set1	Set2	(Measurement)				x	x	x	x
30	AL15 OUTx NE/ND	Variable link L 1/2/3	Set1	Set2	(Measurement)				x	x	x	x
31	AL16 OUTx NE/ND	Variable link L 1/2/3	Set1	Set2	(Measurement)				x	x	x	x
32	Analogue 1	Hi:E	0.0 ... 9999	Hi.A	0.0 ... 100.0%				x	x	x	x
33	Analogue 2	Hi:E	0.0 ... 9999	Hi.A	0.0 ... 100.0%				x	x	x	x
34	Analogue 3	Hi:E	0.0 ... 9999	Hi.A	0.0 ... 100.0%				x	x	x	x
35	Analogue 4	Hi:E	0.0 ... 9999	Hi.A	0.0 ... 100.0%				x	x	x	x
36	Optical	bdr (text)	9.6/19.2/ 38.4/115.2			x	x	x	x	x	x	x
37	COM port	Add (text)	xxx (address)	bdr (text)	9.6/19.2/ 38.4/115.2	x	x	x	x	x	x	x
38	IP address	XXX	XXX	XXX	XXX	x	x	x	x	x	x	x
39	xx.xx.xx xx:xx	Date	Time			x	x	x	x	x	x	x
40	Event page Date Time								x	x	x	x

## Back protection rotary switch

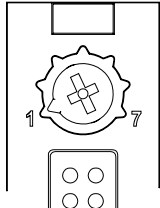
	Function	Rotary switch position	Description
	Unlock	1	All programming parameters are freely modifiable by means of the front key-pad and by means of the communication port.
	Lock	7	The key-pad, as far as programming is concerned and the data through the serial communication cannot be changed (no writing into meter allowed). Data reading is allowed.

## Accuracy (According to EN50470-3 and EN62053-23)

kWh, accuracy (RDG) depending on the current

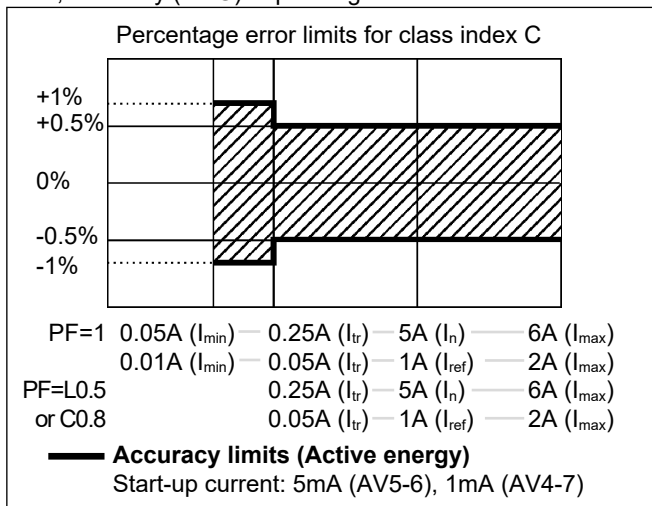

kvarh, accuracy (RDG) depending on the current

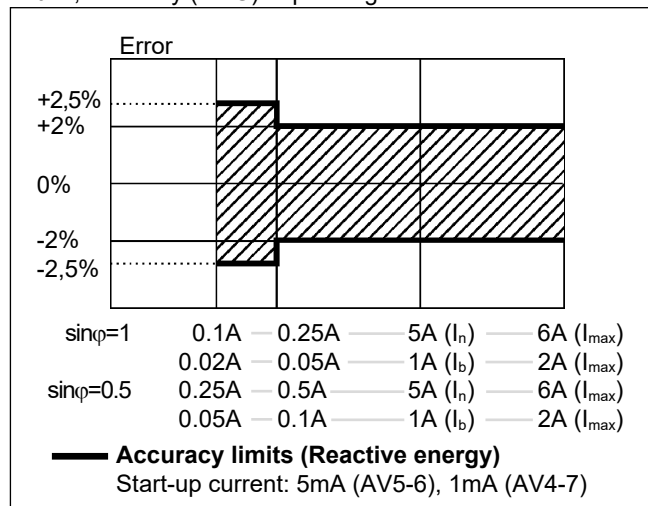

## Used calculation formulas

### Phase variables

Instantaneous effective voltage

$$V_{IN} = \sqrt{\frac{1}{n} \cdot \sum_1^n (V_{IN})_i^2}$$

Instantaneous active power

$$W_1 = \frac{1}{n} \cdot \sum_1^n (V_{IN})_i \cdot (A_1)_i$$

Instantaneous power factor

$$\cos\phi_1 = \frac{W_1}{VA_1}$$

Instantaneous effective current

$$A_1 = \sqrt{\frac{1}{n} \cdot \sum_1^n (A_1)_i^2}$$

Instantaneous apparent power

$$VA_1 = V_{IN} \cdot A_1$$

Instantaneous reactive power

$$\text{var}_1 = \sqrt{(VA_1)^2 - (W_1)^2}$$

### System variables

Equivalent three-phase voltage

$$V_{\Sigma} = \frac{V_1 + V_2 + V_3}{3} \cdot \sqrt{3}$$

Voltage asymmetry

$$ASY_{LL} = \frac{(V_{LLmax} - V_{LLmin})}{V_{LL\Sigma}}$$

$$ASY_{LN} = \frac{(V_{LNmax} - V_{LNmin})}{V_{LN\Sigma}}$$

Three-phase reactive power

$$\text{var}_{\Sigma} = (\text{var}_1 + \text{var}_2 + \text{var}_3)$$

Three-phase active power

$$W_{\Sigma} = W_1 + W_2 + W_3$$

Three-phase apparent power

$$VA_{\Sigma} = \sqrt{W_{\Sigma}^2 + \text{var}_{\Sigma}^2}$$

Total harmonic distortion

$$THD_N = 100 \cdot \frac{\sqrt{\sum_{n=2}^N |X_n|^2}}{|X_1|}$$

Three-phase power factor

$$\cos\phi_{\Sigma} = \frac{W_{\Sigma}}{VA_{\Sigma}} \quad (\text{TPF})$$

### Energy metering

$$k \text{ var hi} = \int_{t_1}^{t_2} Q_i(t) dt \cong \Delta t \sum_{n_1}^{n_2} Q_{nj}$$

$$kWh_i = \int_{t_1}^{t_2} P_i(t) dt \cong \Delta t \sum_{n_1}^{n_2} P_{nj}$$

Where:

i= considered phase (L1, L2 or L3)  
P= active power; Q= reactive power;  
t<sub>1</sub>, t<sub>2</sub>= starting and ending time points of consumption recording; n= time unit;  
Δt= time interval between two successive power consumption;  
n<sub>1</sub>, n<sub>2</sub>= starting and ending discrete time points of consumption recording

# WM3040Soft parameter progr. and var. reading software

**WM3040Soft**

Multi-language software (Italian, English, French, German, Spanish) for variable reading and parameters programming. The program runs under Windows XP/ Vista/7

Data Storing

**Working mode**

Four different working modes can be selected:  
 - management of local RS232 (MODBUS);

Data Transfer

- management of local optical port (MODBUS);  
 - management of a local RS485 network (MODBUS);  
 - managed via TCP port. In pre-formatted CSV files (Excel data base).  
 Manual or automatic at programmable intervals.

## Alarm parameters and logic



Each symbol includes all the settings described in the "alarm" paragraph and listed on the right:

- Enable.
- Variable
- Type
- Latch
- Disable
- Set 1
- Set 2
- OUT
- Delay on. Delay off.
- Function (and/or)

A, B, C... up to 16 locks to control parameters.

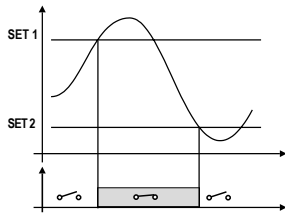

**UP alarm**  
SET1 > SET2

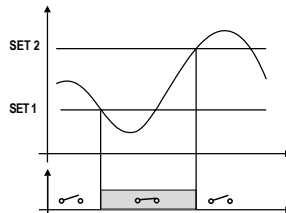

**DOWN alarm**  
SET2 > SET1

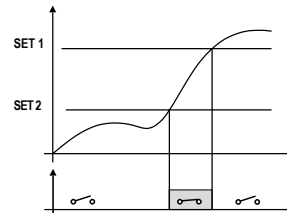

**In-window alarm**  
Alarm is on when the value is between SET 1 and SET 2

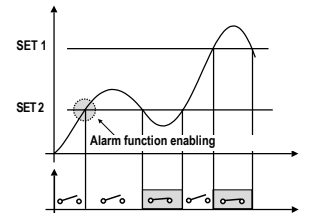

**Ext. window alarm with disabling at power on**  
Alarm is on when value exceeds SET 1 or goes below SET 2

### Example of AND/OR logic alarm:

