



Chipsmall Limited consists of a professional team with an average of over 10 year of expertise in the distribution of electronic components. Based in Hongkong, we have already established firm and mutual-benefit business relationships with customers from,Europe,America and south Asia,supplying obsolete and hard-to-find components to meet their specific needs.

With the principle of “Quality Parts,Customers Priority,Honest Operation,and Considerate Service”,our business mainly focus on the distribution of electronic components. Line cards we deal with include Microchip,ALPS,ROHM,Xilinx,Pulse,ON,Everlight and Freescale. Main products comprise IC,Modules,Potentiometer,IC Socket,Relay,Connector.Our parts cover such applications as commercial,industrial, and automotives areas.

We are looking forward to setting up business relationship with you and hope to provide you with the best service and solution. Let us make a better world for our industry!



Contact us

Tel: +86-755-8981 8866 Fax: +86-755-8427 6832

Email & Skype: info@chipsmall.com Web: www.chipsmall.com

Address: A1208, Overseas Decoration Building, #122 Zhenhua RD., Futian, Shenzhen, China





MCH4014

RF Transistor

12V, 30mA, $f_T=10\text{GHz}$ NPN Single MCPH4

ON Semiconductor®

<http://onsemi.com>

Features

- Low-noise use : $NF=1.2\text{dB}$ typ ($f=1\text{GHz}$)
- High cut-off frequency : $f_T=10\text{GHz}$ typ ($V_{CE}=5\text{V}$)
- High gain : $|S_{21e}|^2=18\text{dB}$ typ ($f=1\text{GHz}$)
- Halogen free compliance

Specifications

Absolute Maximum Ratings at $T_a=25^\circ\text{C}$

Parameter	Symbol	Conditions	Ratings	Unit
Collector to Base Voltage	V_{CBO}		20	V
Collector to Emitter Voltage	V_{CEO}		12	V
Emitter-to-Base Voltage	V_{EBO}		2	V
Collector Current	I_C		30	mA
Collector Dissipation	P_C		350	mW
Junction Temperature	T_j		150	$^\circ\text{C}$
Storage Temperature	T_{stg}		-55 to +150	$^\circ\text{C}$

Stresses exceeding Maximum Ratings may damage the device. Maximum Ratings are stress ratings only. Functional operation above the Recommended Operating Conditions is not implied. Extended exposure to stresses above the Recommended Operating Conditions may affect device reliability.

Package Dimensions

unit : mm (typ)

7020A-002

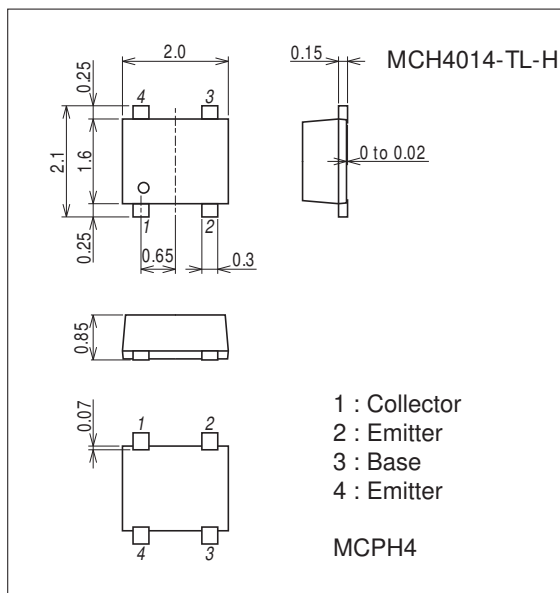

Ordering & Package Information

Device	Package	Shipping	memo
MCH4014-TL-H	MCPH4 SC-82AB, SOT-343, SC-82	3,000 pcs./reel	Pb-Free and Halogen Free

Packing Type: TL

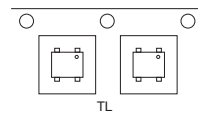

Marking



Electrical Connection

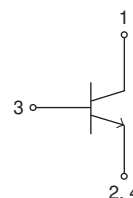

MCH4014

Electrical Characteristics at Ta=25°C

Parameter	Symbol	Conditions	Ratings			Unit
			min	typ	max	
Collector Cutoff Current	I_{CBO}	$V_{CB}=5V, I_E=0A$			1.0	μA
Emitter Cutoff Current	I_{EBO}	$V_{EB}=1V, I_C=0A$			1.0	μA
DC Current Gain	h_{FE}	$V_{CE}=5V, I_C=5mA$	60		150	
Gain-Bandwidth Product	f_T	$V_{CE}=5V, I_C=10mA$	8	10		GHz
Forward Transfer Gain	$ S_{21e} ^2$	$V_{CE}=5V, I_C=10mA, f=1GHz$	15	18		dB
Noise Figure	NF	$V_{CE}=5V, I_C=10mA, f=1GHz$		1.2	1.8	dB

Pay attention to handling since it is liable to be affected by static electricity due to the high-frequency process adopted.

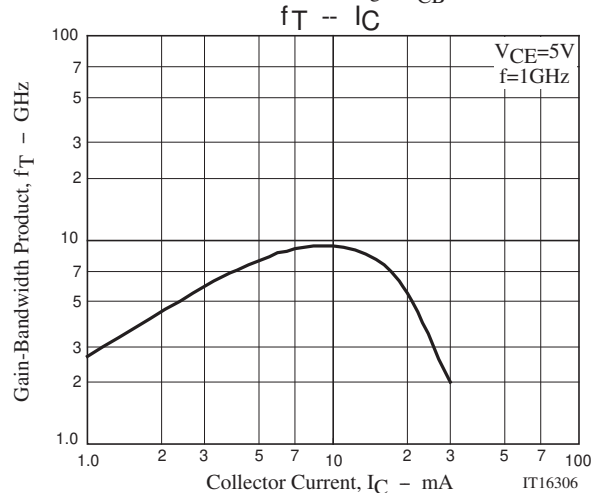
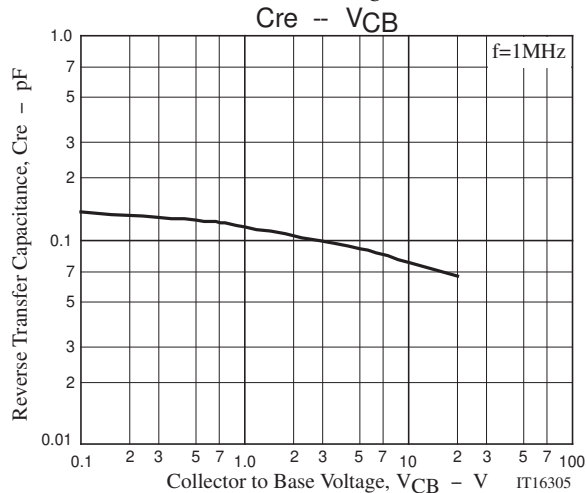
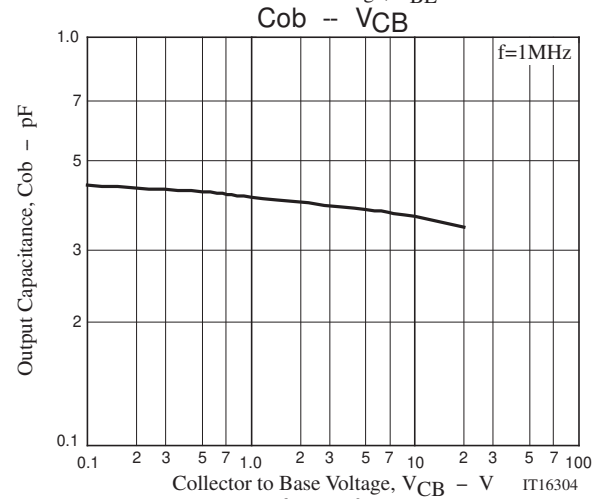
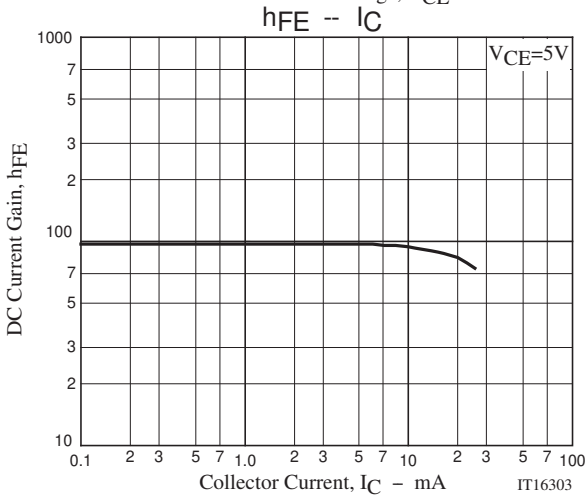
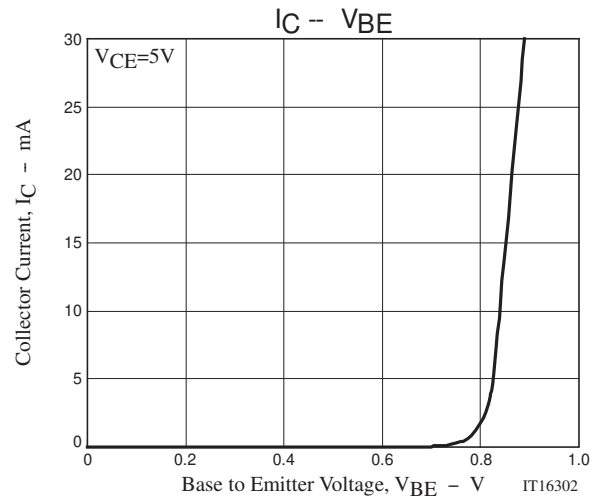
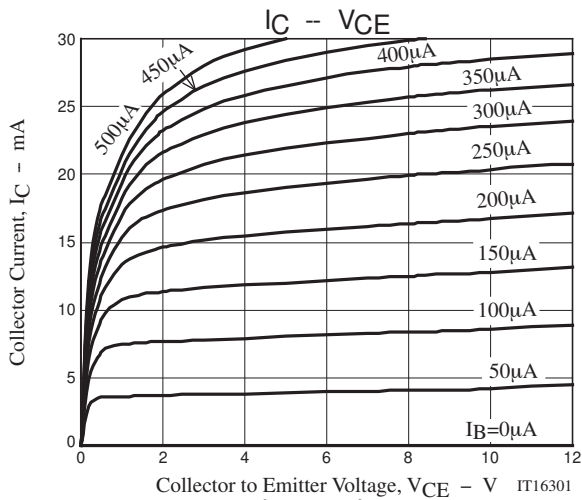

MCH4014

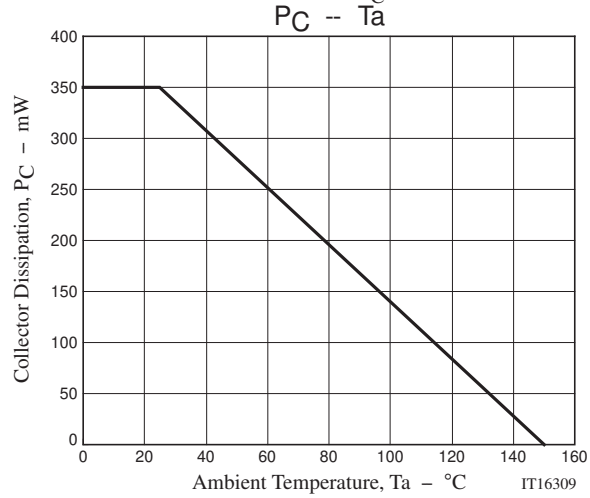
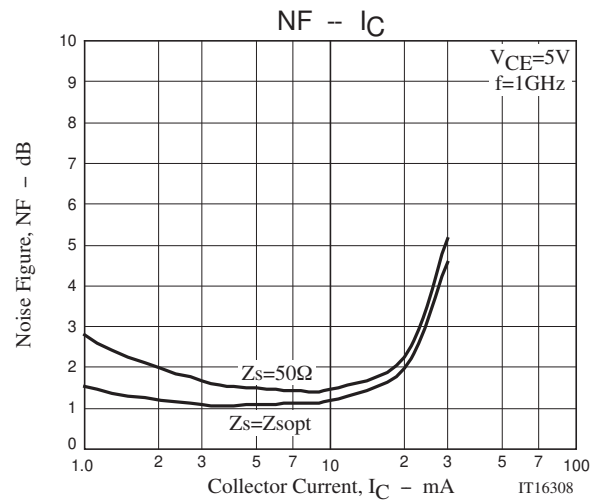
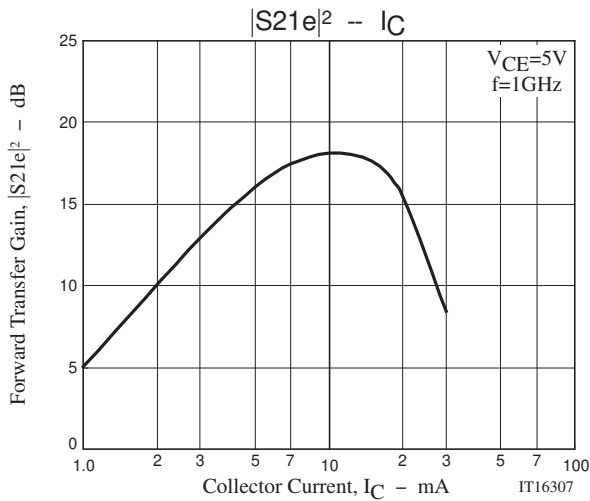

S Parameters (Common emitter)

$V_{CE}=3V, I_C=5mA$

Freq(MHz)	$ S_{11} $	$\angle S_{11}$	$ S_{21} $	$\angle S_{21}$	$ S_{12} $	$\angle S_{12}$	$ S_{22} $	$\angle S_{22}$
100	0.885	-10.8	9.149	167.9	0.006	98.4	0.991	-5.9
200	0.888	-16.7	8.897	156.7	0.013	91.0	0.991	-12.6
300	0.849	-29.7	8.746	150.1	0.020	87.4	0.976	-18.8
400	0.849	-35.3	8.564	143.8	0.027	82.6	0.960	-25.3
500	0.797	-52.2	8.342	134.4	0.035	76.3	0.919	-32.9
600	0.784	-60.4	7.915	128.4	0.042	72.1	0.887	-37.8
700	0.752	-72.5	7.637	121.1	0.047	67.4	0.846	-43.5
800	0.716	-82.3	7.303	114.4	0.052	63.7	0.806	-48.2
900	0.691	269.9	6.819	109.1	0.055	60.5	0.773	-52.4
1000	0.648	260.1	6.603	102.9	0.058	58.4	0.735	-55.7
1200	0.591	245.3	5.916	93.6	0.062	55.2	0.684	-61.5
1400	0.553	234.4	5.241	86.7	0.065	53.9	0.651	-65.5
1600	0.522	225.3	4.694	80.8	0.069	53.9	0.630	-68.6
1800	0.496	217.5	4.224	75.6	0.072	54.3	0.614	-71.1
2000	0.475	210.3	3.835	70.8	0.075	55.2	0.604	-73.5
2200	0.454	203.0	3.532	66.3	0.080	56.5	0.603	-75.4
2400	0.441	196.3	3.267	61.7	0.084	57.4	0.605	-78.2
2600	0.426	189.5	3.033	57.7	0.088	58.6	0.601	-80.1
2800	0.417	183.2	2.861	53.9	0.094	59.9	0.608	-81.3
3000	0.415	177.1	2.700	49.3	0.100	60.0	0.626	-84.1

MCH4014

S Parameters (Common emitter)

V_{CE}=3V, I_C=10mA

Freq(MHz)	S ₁₁	∠S ₁₁	S ₂₁	∠S ₂₁	S ₁₂	∠S ₁₂	S ₂₂	∠S ₂₂
100	0.772	-17.9	14.674	162.9	0.005	91.6	0.981	-7.6
200	0.757	-28.1	13.995	149.9	0.012	86.4	0.967	-15.4
300	0.696	-49.8	13.409	139.6	0.017	81.6	0.931	-22.4
400	0.687	-59.6	12.760	131.8	0.023	78.0	0.893	-29.2
500	0.638	-84.0	11.990	119.8	0.028	72.9	0.832	-36.5
600	0.628	266.0	10.954	113.3	0.033	69.6	0.789	-40.8
700	0.600	251.6	10.102	105.2	0.036	67.3	0.746	-45.6
800	0.582	243.0	9.048	99.8	0.039	65.5	0.705	-49.4
900	0.564	234.3	8.358	94.6	0.042	64.6	0.675	-52.7
1000	0.546	227.8	7.593	90.5	0.044	63.9	0.644	-55.4
1200	0.520	216.4	6.467	83.3	0.049	63.8	0.606	-60.0
1400	0.503	207.8	5.601	77.7	0.054	64.9	0.585	-63.1
1600	0.487	200.5	4.943	72.7	0.059	66.1	0.575	-65.7
1800	0.474	193.8	4.412	68.3	0.064	67.1	0.568	-67.9
2000	0.464	187.4	3.984	64.0	0.070	68.1	0.566	-70.1
2200	0.453	181.1	3.638	60.0	0.076	68.9	0.572	-72.1
2400	0.447	175.5	3.353	55.9	0.083	69.5	0.580	-75.0
2600	0.439	169.7	3.093	52.2	0.089	69.9	0.581	-77.0
2800	0.436	164.4	2.902	48.7	0.097	70.3	0.592	-78.3
3000	0.438	159.4	2.730	44.4	0.105	69.6	0.614	-81.2

V_{CE}=3V, I_C=15mA

Freq(MHz)	S ₁₁	∠S ₁₁	S ₂₁	∠S ₂₁	S ₁₂	∠S ₁₂	S ₂₂	∠S ₂₂
100	0.658	-27.9	17.323	158.7	0.007	76.6	0.954	-8.8
200	0.626	-45.6	15.793	144.0	0.011	74.7	0.917	-16.8
300	0.580	-77.0	14.532	129.9	0.016	73.2	0.865	-23.0
400	0.574	267.3	12.943	120.3	0.019	71.7	0.817	-28.2
500	0.566	244.1	11.483	108.1	0.023	69.0	0.761	-33.8
600	0.567	234.2	10.197	101.8	0.026	67.5	0.726	-37.0
700	0.565	223.8	8.885	95.3	0.028	68.3	0.695	-40.6
800	0.561	216.8	7.827	90.7	0.031	68.4	0.667	-43.7
900	0.558	210.6	7.057	86.4	0.033	69.1	0.649	-46.3
1000	0.551	205.6	6.338	82.9	0.036	69.8	0.629	-48.7
1200	0.544	197.0	5.285	76.6	0.041	71.6	0.608	-53.1
1400	0.538	190.2	4.539	71.3	0.046	73.4	0.600	-56.4
1600	0.532	184.2	3.977	66.5	0.053	75.1	0.601	-59.5
1800	0.526	178.6	3.536	62.1	0.059	76.2	0.602	-62.3
2000	0.522	173.1	3.182	57.9	0.066	77.2	0.606	-65.1
2200	0.517	167.5	2.894	53.8	0.073	77.8	0.617	-67.7
2400	0.514	162.6	2.657	49.7	0.081	77.9	0.628	-71.1
2600	0.511	157.4	2.439	45.9	0.089	77.9	0.632	-73.7
2800	0.511	152.7	2.277	42.3	0.098	77.8	0.646	-75.5
3000	0.513	148.3	2.136	38.0	0.107	76.6	0.671	-79.0

MCH4014

S Parameters (Common emitter)

V_{CE}=3V, I_C=20mA

Freq(MHz)	S11	∠S11	S21	∠S21	S12	∠S12	S22	∠S22
100	0.549	-44.6	18.205	153.5	0.008	79.1	0.907	-10.1
200	0.527	-76.1	15.342	135.9	0.011	62.5	0.842	-16.7
300	0.543	248.7	12.862	118.8	0.014	63.2	0.790	-21.1
400	0.558	231.8	10.435	108.2	0.016	62.9	0.755	-24.4
500	0.584	215.9	8.577	98.2	0.018	63.7	0.716	-28.7
600	0.593	208.7	7.275	92.7	0.021	66.6	0.696	-31.1
700	0.603	201.7	6.174	87.3	0.023	68.5	0.681	-34.3
800	0.606	196.9	5.422	83.4	0.025	71.2	0.665	-37.2
900	0.610	192.5	4.769	79.5	0.028	73.0	0.657	-39.8
1000	0.608	189.0	4.284	76.3	0.030	74.7	0.646	-42.4
1200	0.608	182.6	3.525	70.3	0.036	78.4	0.639	-47.3
1400	0.607	177.4	3.011	65.2	0.042	80.9	0.641	-51.4
1600	0.605	172.4	2.624	60.2	0.049	82.5	0.648	-55.2
1800	0.603	167.7	2.328	55.7	0.056	83.9	0.654	-58.8
2000	0.602	162.9	2.091	51.3	0.064	84.4	0.661	-62.2
2200	0.600	157.9	1.897	47.1	0.073	84.7	0.673	-65.5
2400	0.599	153.5	1.732	42.8	0.081	84.6	0.686	-69.5
2600	0.598	148.7	1.584	38.9	0.090	84.2	0.690	-72.6
2800	0.598	144.3	1.474	35.2	0.100	83.6	0.706	-75.0
3000	0.600	140.3	1.377	30.8	0.111	82.0	0.731	-79.0

V_{CE}=5V, I_C=5mA

Freq(MHz)	S11	∠S11	S21	∠S21	S12	∠S12	S22	∠S22
100	0.890	-10.5	9.159	168.3	0.006	97.5	0.994	-5.7
200	0.895	-16.1	8.952	157.5	0.012	91.7	0.995	-11.9
300	0.857	-28.6	8.775	150.8	0.019	88.8	0.982	-17.9
400	0.858	-34.1	8.515	144.6	0.026	85.2	0.969	-24.1
500	0.807	-50.6	8.382	135.3	0.033	79.0	0.931	-31.5
600	0.794	-58.8	7.984	129.2	0.040	74.2	0.900	-36.3
700	0.762	-70.5	7.684	122.0	0.045	69.6	0.862	-42.0
800	0.724	-80.4	7.385	115.1	0.050	65.6	0.823	-46.6
900	0.700	-87.9	6.977	109.9	0.053	62.3	0.790	-50.8
1000	0.656	262.1	6.691	103.6	0.056	60.2	0.752	-54.1
1200	0.597	247.3	6.001	94.2	0.060	57.0	0.701	-59.8
1400	0.557	236.3	5.323	87.2	0.064	55.5	0.668	-63.8
1600	0.525	227.3	4.769	81.3	0.066	55.5	0.647	-66.9
1800	0.498	219.4	4.288	76.0	0.070	56.0	0.631	-69.8
2000	0.476	212.2	3.897	71.1	0.073	56.9	0.621	-71.8
2200	0.454	204.8	3.588	66.6	0.077	58.2	0.620	-73.8
2400	0.440	198.1	3.319	62.0	0.082	59.1	0.622	-76.6
2600	0.425	191.2	3.081	58.0	0.086	60.5	0.618	-78.6
2800	0.415	184.9	2.906	54.1	0.092	61.7	0.626	-79.8
3000	0.413	178.7	2.743	49.5	0.098	61.8	0.644	-82.6

MCH4014

S Parameters (Common emitter)

V_{CE}=5V, I_C=10mA

Freq(MHz)	S ₁₁	∠S ₁₁	S ₂₁	∠S ₂₁	S ₁₂	∠S ₁₂	S ₂₂	∠S ₂₂
100	0.786	-15.9	15.297	164.4	0.004	84.8	0.985	-6.9
200	0.783	-25.0	14.577	151.8	0.011	89.1	0.977	-14.4
300	0.724	-45.0	14.127	141.8	0.016	86.4	0.947	-21.2
400	0.718	-53.7	13.473	134.2	0.022	81.6	0.914	-27.9
500	0.658	-77.4	12.720	122.1	0.027	75.2	0.857	-35.2
600	0.645	-87.3	11.734	115.6	0.031	72.3	0.814	-39.6
700	0.611	257.7	10.764	107.2	0.035	69.8	0.771	-44.5
800	0.588	248.7	9.679	101.5	0.038	68.0	0.730	-48.4
900	0.567	239.6	8.908	96.2	0.041	66.7	0.698	-51.7
1000	0.546	232.6	8.103	91.9	0.043	66.2	0.666	-54.5
1200	0.515	220.7	6.875	84.5	0.048	65.7	0.625	-59.1
1400	0.495	211.6	5.944	78.8	0.053	66.2	0.602	-62.3
1600	0.478	204.0	5.233	73.8	0.058	67.3	0.591	-64.9
1800	0.463	197.1	4.667	69.3	0.063	68.2	0.583	-67.0
2000	0.452	190.6	4.211	65.0	0.069	69.3	0.579	-69.2
2200	0.440	184.1	3.845	61.0	0.075	70.1	0.585	-71.2
2400	0.433	178.3	3.538	56.9	0.082	70.5	0.592	-74.0
2600	0.425	172.3	3.263	53.3	0.088	71.0	0.592	-75.9
2800	0.421	167.0	3.059	49.8	0.096	71.3	0.604	-77.2
3000	0.423	161.8	2.878	45.5	0.104	70.6	0.625	-80.2

V_{CE}=5V, I_C=15mA

Freq(MHz)	S ₁₁	∠S ₁₁	S ₂₁	∠S ₂₁	S ₁₂	∠S ₁₂	S ₂₂	∠S ₂₂
100	0.690	-23.0	18.633	161.1	0.004	89.2	0.977	-7.7
200	0.671	-37.6	17.368	147.1	0.010	85.7	0.954	-15.5
300	0.614	-64.9	16.210	134.0	0.014	82.3	0.912	-22.2
400	0.604	-78.6	14.819	124.8	0.019	78.2	0.868	-28.1
500	0.571	257.3	13.309	112.3	0.023	75.6	0.808	-34.5
600	0.567	246.6	12.148	105.7	0.026	72.8	0.768	-38.2
700	0.555	235.0	10.514	98.8	0.029	71.6	0.730	-42.3
800	0.547	227.1	9.296	93.9	0.032	71.3	0.696	-45.5
900	0.539	220.1	8.434	89.4	0.035	71.4	0.671	-48.4
1000	0.529	214.5	7.590	85.8	0.037	72.0	0.645	-50.8
1200	0.515	205.0	6.371	79.3	0.042	72.4	0.616	-55.1
1400	0.505	197.5	5.483	74.1	0.048	73.6	0.602	-58.2
1600	0.495	191.0	4.816	69.4	0.054	74.7	0.598	-60.9
1800	0.487	184.9	4.285	65.1	0.060	75.7	0.595	-63.4
2000	0.481	179.1	3.860	60.9	0.066	76.5	0.596	-65.8
2200	0.473	173.3	3.516	57.0	0.074	76.8	0.605	-68.1
2400	0.470	168.1	3.234	53.0	0.081	76.9	0.615	-71.2
2600	0.465	162.7	2.975	49.3	0.088	77.1	0.617	-73.5
2800	0.463	157.8	2.784	45.9	0.097	77.0	0.631	-75.0
3000	0.466	153.2	2.616	41.6	0.106	75.9	0.654	-78.3

MCH4014

S Parameters (Common emitter)

$V_{CE}=5V, I_C=20mA$

Freq(MHz)	S11	$\angle S11$	S21	$\angle S21$	S12	$\angle S12$	S22	$\angle S22$
100	0.590	-34.1	20.159	157.3	0.004	89.1	0.951	-8.1
200	0.566	-57.8	18.680	141.3	0.009	75.1	0.911	-15.4
300	0.542	268.4	15.660	125.2	0.013	73.1	0.862	-20.7
400	0.543	251.1	13.055	114.8	0.015	73.2	0.822	-25.1
500	0.552	231.6	11.336	103.8	0.018	73.1	0.775	-30.0
600	0.558	222.5	9.699	97.8	0.021	73.8	0.747	-32.8
700	0.563	213.8	8.425	91.9	0.023	74.6	0.723	-36.1
800	0.564	207.7	7.401	87.6	0.026	75.0	0.701	-39.1
900	0.566	202.4	6.573	83.6	0.029	76.5	0.687	-41.7
1000	0.563	198.0	5.899	80.3	0.031	77.5	0.670	-44.2
1200	0.560	190.5	4.872	74.2	0.037	79.7	0.655	-48.7
1400	0.557	184.4	4.165	69.1	0.043	81.5	0.651	-52.4
1600	0.553	178.9	3.633	64.4	0.049	82.9	0.654	-55.8
1800	0.550	173.7	3.225	59.9	0.056	83.8	0.656	-58.9
2000	0.548	168.5	2.897	55.7	0.064	84.4	0.661	-62.0
2200	0.544	163.2	2.631	51.7	0.072	84.5	0.672	-65.0
2400	0.543	158.6	2.407	47.5	0.080	84.4	0.684	-68.7
2600	0.541	153.5	2.206	43.7	0.089	84.1	0.687	-71.5
2800	0.541	149.0	2.056	40.2	0.098	83.6	0.702	-73.6
3000	0.543	144.8	1.925	35.7	0.109	82.0	0.727	-77.4

$V_{CE}=8V, I_C=5mA$

Freq(MHz)	S11	$\angle S11$	S21	$\angle S21$	S12	$\angle S12$	S22	$\angle S22$
100	0.895	-10.3	9.140	168.5	0.005	104.3	0.993	-5.4
200	0.899	-15.8	8.948	157.7	0.011	95.9	0.997	-11.4
300	0.861	-28.2	8.761	151.1	0.017	91.9	0.985	-17.1
400	0.863	-33.7	8.569	144.9	0.024	86.3	0.974	-23.2
500	0.814	-49.9	8.378	135.6	0.032	80.2	0.940	-30.3
600	0.799	-58.0	7.994	129.6	0.038	76.0	0.910	-35.0
700	0.769	-69.6	7.683	122.3	0.043	71.1	0.873	-40.5
800	0.730	-79.5	7.405	115.4	0.047	67.1	0.835	-45.0
900	0.706	-86.9	7.086	110.2	0.051	63.9	0.803	-49.2
1000	0.661	263.1	6.712	103.9	0.054	61.8	0.766	-52.4
1200	0.601	248.3	6.025	94.4	0.058	58.6	0.716	-58.1
1400	0.561	237.4	5.346	87.4	0.061	57.2	0.683	-62.1
1600	0.528	228.3	4.790	81.3	0.064	57.0	0.663	-65.1
1800	0.500	220.4	4.303	76.1	0.068	57.5	0.648	-68.2
2000	0.477	213.1	3.913	71.1	0.071	58.5	0.638	-70.1
2200	0.456	205.8	3.602	66.5	0.075	59.9	0.636	-72.2
2400	0.440	199.0	3.332	61.9	0.080	60.9	0.640	-75.0
2600	0.425	192.1	3.091	57.9	0.084	62.3	0.635	-77.0
2800	0.415	185.7	2.915	53.9	0.090	63.7	0.643	-78.3
3000	0.413	179.5	2.752	49.3	0.097	63.9	0.662	-81.2

MCH4014

S Parameters (Common emitter)

V_{CE}=8V, I_C=10mA

Freq(MHz)	S ₁₁	∠S ₁₁	S ₂₁	∠S ₂₁	S ₁₂	∠S ₁₂	S ₂₂	∠S ₂₂
100	0.800	-14.8	15.446	165.2	0.004	97.8	0.988	-6.4
200	0.800	-23.6	14.773	152.8	0.010	90.4	0.982	-13.6
300	0.741	-42.8	14.286	142.9	0.015	87.2	0.957	-20.1
400	0.738	-50.8	13.553	135.5	0.021	82.8	0.926	-26.6
500	0.672	-74.3	12.891	123.3	0.026	77.6	0.873	-33.8
600	0.659	-84.2	11.828	116.7	0.030	74.6	0.832	-38.2
700	0.621	260.7	10.924	108.2	0.034	71.9	0.790	-43.0
800	0.595	251.5	9.849	102.4	0.037	69.7	0.749	-46.9
900	0.573	242.3	9.050	97.0	0.040	68.3	0.717	-50.2
1000	0.550	235.2	8.241	92.5	0.042	67.6	0.685	-53.0
1200	0.517	223.0	6.985	85.0	0.047	67.2	0.644	-57.6
1400	0.496	213.7	6.037	79.2	0.051	67.5	0.621	-60.8
1600	0.477	205.9	5.312	74.2	0.056	68.6	0.609	-63.4
1800	0.461	198.9	4.734	69.6	0.062	69.5	0.600	-65.6
2000	0.449	192.3	4.273	65.3	0.067	70.5	0.597	-67.8
2200	0.437	185.8	3.898	61.3	0.074	71.3	0.602	-69.8
2400	0.429	179.9	3.586	57.1	0.080	71.8	0.609	-72.7
2600	0.420	173.8	3.305	53.4	0.086	72.2	0.609	-74.7
2800	0.417	168.4	3.098	49.9	0.094	72.6	0.621	-76.0
3000	0.418	163.1	2.915	45.6	0.102	71.9	0.642	-79.0

V_{CE}=8V, I_C=15mA

Freq(MHz)	S ₁₁	∠S ₁₁	S ₂₁	∠S ₂₁	S ₁₂	∠S ₁₂	S ₂₂	∠S ₂₂
100	0.709	-20.9	19.385	162.4	0.006	103.7	0.982	-7.2
200	0.697	-34.3	18.267	148.6	0.009	85.4	0.966	-14.6
300	0.638	-59.6	17.076	135.9	0.014	85.2	0.930	-21.1
400	0.626	-72.1	15.568	126.9	0.018	81.0	0.889	-27.1
500	0.581	263.6	14.172	114.3	0.022	77.5	0.832	-33.7
600	0.574	252.7	12.755	107.5	0.026	75.6	0.790	-37.5
700	0.557	240.4	11.234	100.4	0.029	74.2	0.752	-41.7
800	0.545	232.0	9.951	95.2	0.031	73.4	0.716	-45.1
900	0.535	224.6	9.003	90.7	0.034	73.0	0.690	-47.9
1000	0.523	218.7	8.110	86.9	0.037	72.8	0.663	-50.5
1200	0.506	208.7	6.790	80.4	0.042	73.3	0.631	-54.7
1400	0.495	200.8	5.833	75.1	0.047	74.5	0.614	-57.8
1600	0.484	194.0	5.113	70.4	0.053	75.5	0.609	-60.5
1800	0.474	187.8	4.548	66.0	0.059	76.3	0.605	-62.9
2000	0.467	181.8	4.094	61.9	0.066	76.9	0.605	-65.2
2200	0.459	175.8	3.728	58.0	0.073	77.5	0.613	-67.5
2400	0.455	170.5	3.426	53.9	0.080	77.6	0.622	-70.5
2600	0.449	164.9	3.151	50.3	0.087	77.7	0.624	-72.7
2800	0.447	159.9	2.948	46.9	0.096	77.8	0.638	-74.2
3000	0.450	155.2	2.771	42.6	0.105	76.5	0.661	-77.4

MCH4014

S Parameters (Common emitter)

V_{CE}=8V, I_C=20mA

Freq(MHz)	S ₁₁	∠S ₁₁	S ₂₁	∠S ₂₁	S ₁₂	∠S ₁₂	S ₂₂	∠S ₂₂
100	0.625	-28.6	21.189	159.5	0.003	96.6	0.972	-7.4
200	0.605	-48.6	19.191	144.3	0.009	84.0	0.944	-14.7
300	0.562	-79.4	17.244	129.0	0.012	81.0	0.901	-20.5
400	0.554	264.2	15.103	118.9	0.015	79.6	0.859	-25.6
500	0.545	243.0	13.058	107.4	0.019	77.5	0.808	-31.1
600	0.547	233.0	11.235	101.1	0.022	76.9	0.774	-34.3
700	0.545	223.3	9.930	95.0	0.024	76.6	0.744	-37.8
800	0.543	216.3	8.732	90.4	0.027	77.2	0.716	-40.9
900	0.542	210.4	7.830	86.2	0.030	77.3	0.697	-43.6
1000	0.536	205.4	7.027	82.8	0.033	78.4	0.676	-46.0
1200	0.530	197.0	5.845	76.7	0.038	79.4	0.653	-50.4
1400	0.524	190.3	5.010	71.6	0.044	80.7	0.645	-53.8
1600	0.518	184.4	4.383	67.0	0.050	81.8	0.644	-56.8
1800	0.512	178.8	3.893	62.6	0.057	82.6	0.644	-59.7
2000	0.509	173.3	3.502	58.5	0.064	83.3	0.647	-62.4
2200	0.503	167.8	3.183	54.6	0.071	83.4	0.657	-65.1
2400	0.501	162.9	2.921	50.5	0.079	83.3	0.668	-68.6
2600	0.498	157.7	2.681	46.8	0.087	83.0	0.670	-71.1
2800	0.497	153.0	2.504	43.3	0.097	82.7	0.685	-73.0
3000	0.501	148.7	2.349	39.0	0.106	81.1	0.710	-76.5

MCH4014

Outline Drawing

MCH4014-TL-H

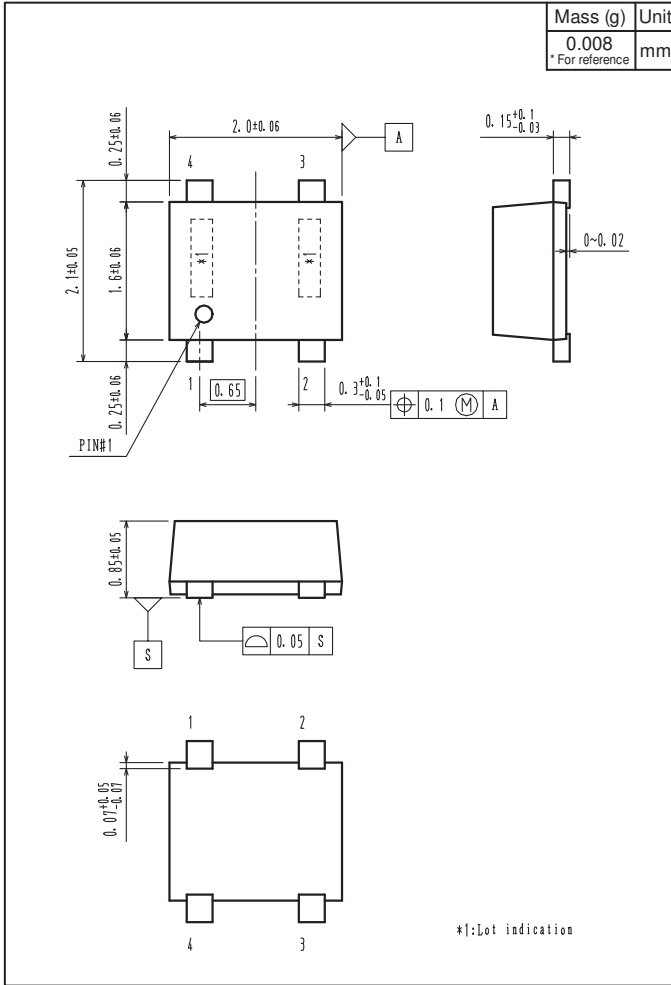

Land Pattern Example

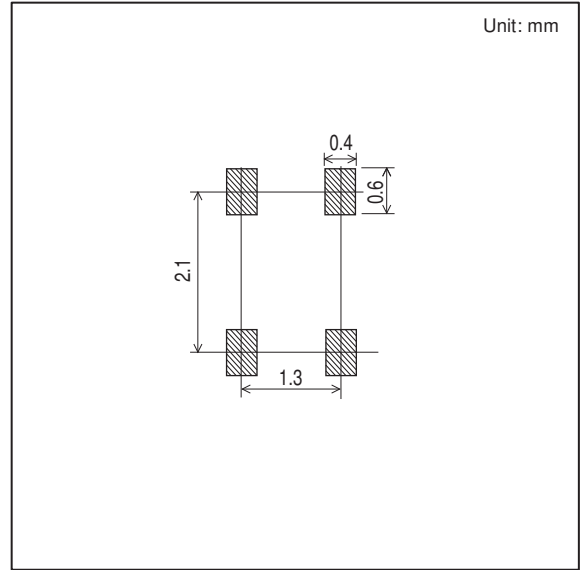

ON Semiconductor and the ON logo are registered trademarks of Semiconductor Components Industries, LLC (SCILLC). SCILLC owns the rights to a number of patents, trademarks, copyrights, trade secrets, and other intellectual property. A listing of SCILLC's product/patent coverage may be accessed at www.onsemi.com/site/pdf/Patent-Marking.pdf. SCILLC reserves the right to make changes without further notice to any products herein. SCILLC makes no warranty, representation or guarantee regarding the suitability of its products for any particular purpose, nor does SCILLC assume any liability arising out of the application or use of any product or circuit, and specifically disclaims any and all liability, including without limitation special, consequential or incidental damages. "Typical" parameters which may be provided in SCILLC data sheets and/or specifications can and do vary in different applications and actual performance may vary over time. All operating parameters, including "Typicals" must be validated for each customer application by customer's technical experts. SCILLC does not convey any license under its patent rights nor the rights of others. SCILLC products are not designed, intended, or authorized for use as components in systems intended for surgical implant into the body, or other applications intended to support or sustain life, or for any other application in which the failure of the SCILLC product could create a situation where personal injury or death may occur. Should Buyer purchase or use SCILLC products for any such unintended or unauthorized application, Buyer shall indemnify and hold SCILLC and its officers, employees, subsidiaries, affiliates, and distributors harmless against all claims, costs, damages, and expenses, and reasonable attorney fees arising out of, directly or indirectly, any claim of personal injury or death associated with such unintended or unauthorized use, even if such claim alleges that SCILLC was negligent regarding the design or manufacture of the part. SCILLC is an Equal Opportunity/Affirmative Action Employer. This literature is subject to all applicable copyright laws and is not for resale in any manner.