



Chipsmall Limited consists of a professional team with an average of over 10 year of expertise in the distribution of electronic components. Based in Hongkong, we have already established firm and mutual-benefit business relationships with customers from,Europe,America and south Asia,supplying obsolete and hard-to-find components to meet their specific needs.

With the principle of "Quality Parts,Customers Priority,Honest Operation,and Considerate Service",our business mainly focus on the distribution of electronic components. Line cards we deal with include Microchip,ALPS,ROHM,Xilinx,Pulse,ON,Everlight and Freescale. Main products comprise IC,Modules,Potentiometer,IC Socket,Relay,Connector.Our parts cover such applications as commercial,industrial, and automotives areas.

We are looking forward to setting up business relationship with you and hope to provide you with the best service and solution. Let us make a better world for our industry!



## Contact us

Tel: +86-755-8981 8866 Fax: +86-755-8427 6832

Email & Skype: info@chipsmall.com Web: www.chipsmall.com

Address: A1208, Overseas Decoration Building, #122 Zhenhua RD., Futian, Shenzhen, China





# MCH4020

## RF Transistor

8V, 150mA,  $f_T=16\text{GHz}$ , NPN Single MCPH4

ON Semiconductor®

<http://onsemi.com>

### Features

- Low-noise use :  $NF=1.2\text{dB}$  typ ( $f=1\text{GHz}$ )
- High cut-off frequency :  $f_T=16\text{GHz}$  typ ( $V_{CE}=5\text{V}$ )
- High gain :  $|S_{21e}|^2=17.5\text{dB}$  typ ( $f=1\text{GHz}$ )
- Halogen free compliance

### Specifications

**Absolute Maximum Ratings** at  $T_a=25^\circ\text{C}$

Parameter	Symbol	Conditions	Ratings	Unit
Collector-to-Base Voltage	$V_{CBO}$		15	V
Collector-to-Emitter Voltage	$V_{CEO}$		8	V
Emitter-to-Base Voltage	$V_{EBO}$		2	V
Collector Current	$I_C$		150	mA
Collector Dissipation	$P_C$		400	mW
Junction Temperature	$T_j$		150	$^\circ\text{C}$
Storage Temperature	$T_{stg}$		-55 to +150	$^\circ\text{C}$

Stresses exceeding Maximum Ratings may damage the device. Maximum Ratings are stress ratings only. Functional operation above the Recommended Operating Conditions is not implied. Extended exposure to stresses above the Recommended Operating Conditions may affect device reliability.

### Package Dimensions

unit : mm (typ)

7020A-002

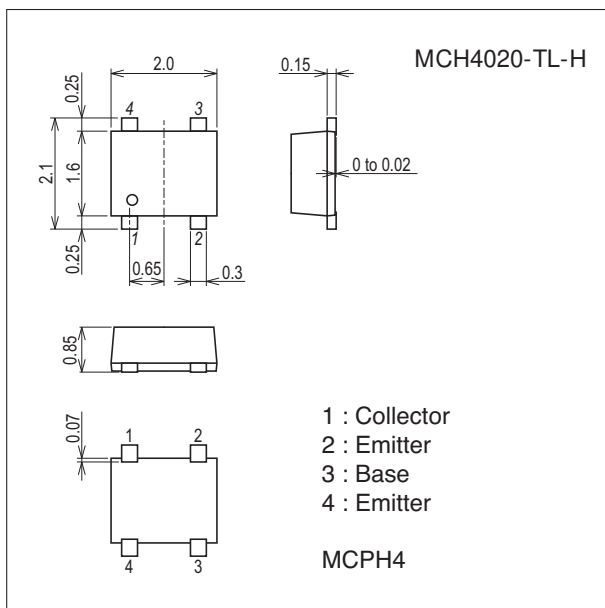

### Product & Package Information

- Package : MCPH4
- JEITA, JEDEC : SC-82, SC-82AB, SOT-343
- Minimum Packing Quantity : 3,000 pcs./reel

### Packing Type : TL

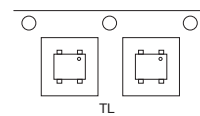

### Marking

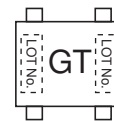

### Electrical Connection

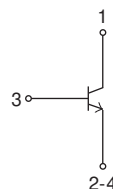

# MCH4020

## Electrical Characteristics at Ta=25°C

Parameter	Symbol	Conditions	Ratings			Unit
			min	typ	max	
Collector Cutoff Current	ICBO	V <sub>CB</sub> =5V, I <sub>E</sub> =0A			1.0	μA
Emitter Cutoff Current	IEBO	V <sub>EB</sub> =1V, I <sub>C</sub> =0A			1.0	μA
DC Current Gain	h <sub>FE</sub>	V <sub>CE</sub> =5V, I <sub>C</sub> =50mA	60		150	
Gain-Bandwidth Product	f <sub>T</sub>	V <sub>CE</sub> =5V, I <sub>C</sub> =50mA	13	16		GHz
Forward Transfer Gain	S <sub>21e</sub>   <sup>2</sup>	V <sub>CE</sub> =5V, I <sub>C</sub> =50mA, f=1GHz		17.5		dB
Noise Figure	NF	V <sub>CE</sub> =1V, I <sub>C</sub> =10mA, f=1GHz		1.2	1.8	dB

Note) Pay attention to handling since it is liable to be affected by static electricity due to the high-frequency process adopted.

## Ordering Information

Device	Package	Shipping	memo
MCH4020-TL-H	MCPH4	3,000pcs./reel	Pb Free and Halogen Free

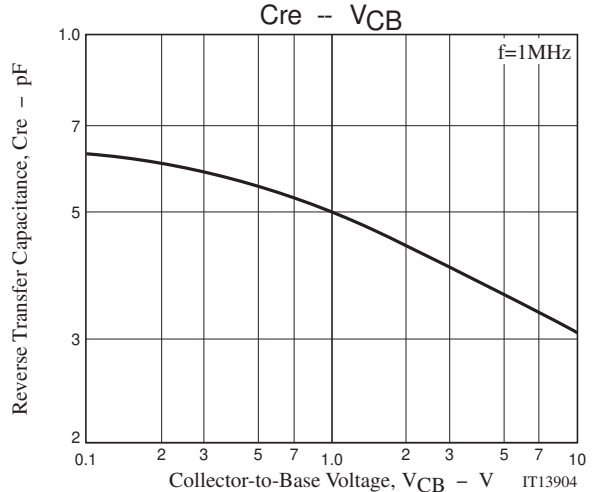
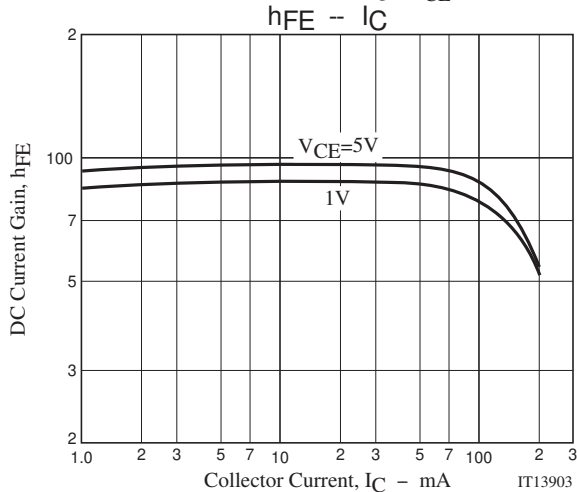
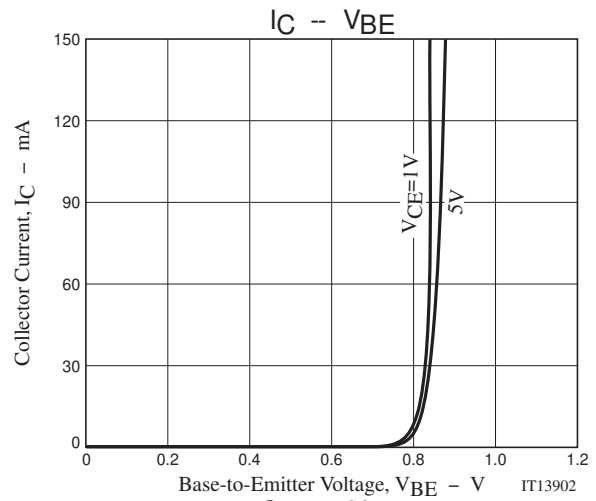
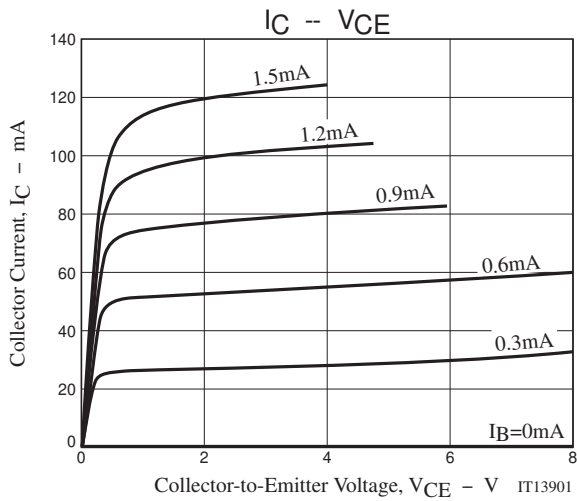

# MCH4020

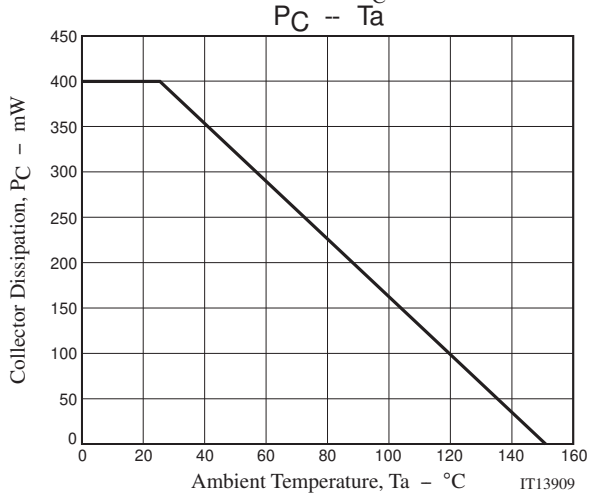
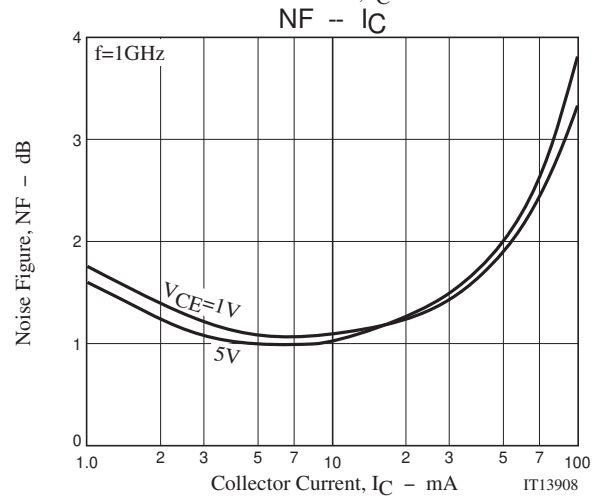
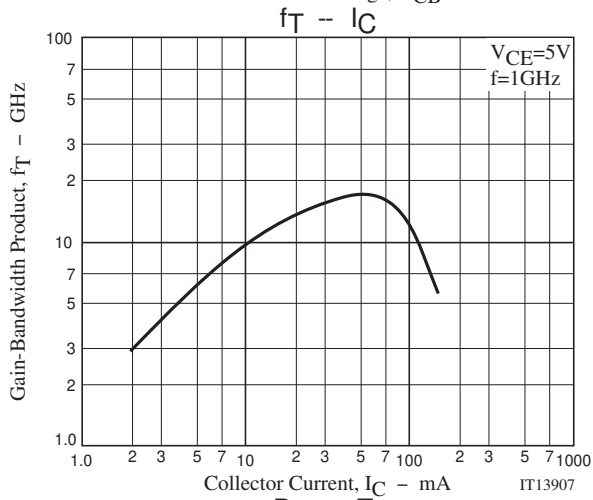
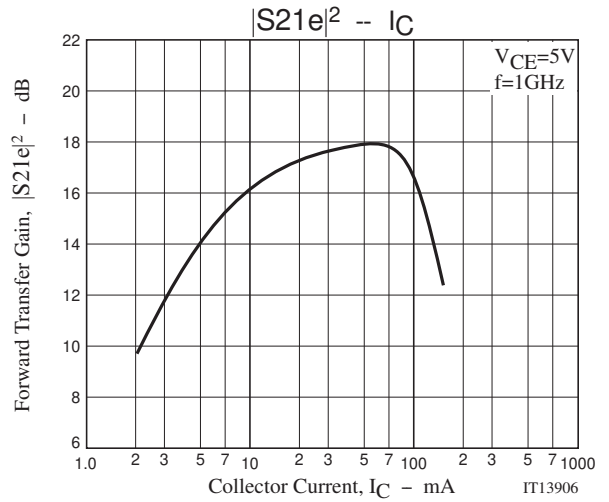
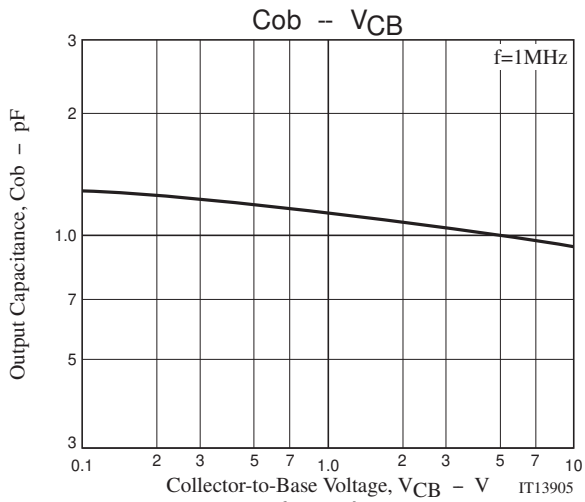

# MCH4020

## SPICE Parameters

model: Gummel-Poon

Parameter	Value	Unit	Parameter	Value	Unit
IS	2.155f	A	TF	6.700p	S
BF	122		XTF	50.00f	
NF	1.05		VTF	750.0m	V
VAF	8	V	ITF	50	A
IKF	206.4m	A	PTF	200.0m	°C
ISE	1.384p	A	CJC	175.0f	F
NE	2.278		VJC	200.0f	V
BR	14		MJC	1.150p	
NR	1.042		XCJC	1	
VAR	4	V	TR	0	S
IKR	360.0m	A	FC	500.0m	
ISC	140.0f	A	CJS	550.0f	F
NC	1.6		VJS	150.0m	V
RB	2	Ω	MJS	136.0m	
IRB	1.5	A	Lfc	110.0p	H
RBM	25.00m	Ω	Lwb	850.0p	H
RE	450.0m	Ω	Lfb	73.0p	H
RC	1.2	Ω	Lwe	145.0p	H
XTB	0		Lfe	280.0p	H
EG	1.11	eV	Cbc	325.0f	F
XTI	1		Ceb	175.0f	F
CJE	2.476p	F	Cce	120.0f	F
VJE	750.0m	V			
MJE	10.00m				

## Schematic

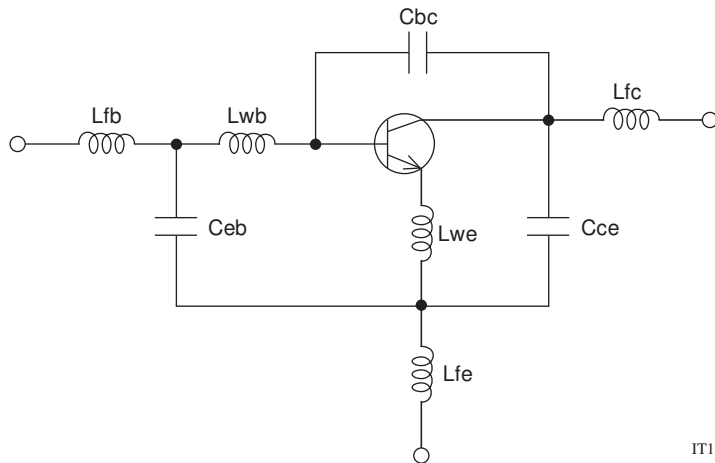

IT13901

\*Information (including circuit diagrams and circuit parameters) herein is for example only ; it is not guaranteed for volume production.

# MCH4020

## S Parameters (Common emitter)

V<sub>CE</sub>=1V, I<sub>C</sub>=10mA

Freq(MHz)	S11	∠S11	S21	∠S21	S12	∠S12	S22	∠S22
200	0.664	-88.0	17.728	131.6	0.046	52.6	0.753	-60.7
400	0.674	-130.4	11.682	107.8	0.061	40.5	0.567	-93.8
600	0.681	-147.2	8.523	95.7	0.071	38.0	0.513	-106.8
800	0.666	-160.0	6.411	87.9	0.076	38.4	0.445	-118.0
1000	0.658	-168.7	5.131	82.2	0.082	39.7	0.414	-126.1
1200	0.657	-175.3	4.280	77.4	0.087	41.3	0.393	-132.2
1400	0.657	179.2	3.679	73.1	0.093	42.8	0.382	-136.8
1600	0.657	174.3	3.228	69.2	0.100	44.4	0.375	-141.0
1800	0.658	170.2	2.878	65.5	0.107	45.5	0.372	-143.9
2000	0.659	166.6	2.608	62.0	0.114	46.5	0.372	-146.8
2200	0.657	162.8	2.379	58.7	0.122	47.2	0.374	-149.0
2400	0.658	159.4	2.193	55.3	0.130	47.6	0.378	-151.2
2600	0.657	156.0	2.041	52.2	0.138	47.8	0.384	-153.4
2800	0.657	152.7	1.909	49.0	0.146	47.9	0.390	-154.6
3000	0.655	149.4	1.793	46.0	0.155	47.8	0.399	-156.0
3200	0.652	146.0	1.693	42.9	0.163	47.5	0.409	-157.2
3400	0.652	142.6	1.605	39.9	0.172	47.1	0.419	-158.1
3600	0.651	139.0	1.528	37.1	0.180	46.6	0.432	-158.9
3800	0.650	135.6	1.456	34.2	0.189	45.8	0.443	-159.6
4000	0.650	131.8	1.393	31.3	0.198	45.0	0.455	-160.2
4200	0.650	128.2	1.337	28.6	0.206	44.2	0.467	-160.8
4400	0.652	124.6	1.281	26.0	0.215	43.3	0.479	-161.2
4600	0.653	120.8	1.233	23.5	0.224	42.2	0.489	-161.5
4800	0.654	117.3	1.185	20.8	0.232	41.1	0.499	-161.7
5000	0.656	113.8	1.147	18.4	0.240	40.0	0.508	-162.1

V<sub>CE</sub>=1V, I<sub>C</sub>=50mA

Freq(MHz)	S11	∠S11	S21	∠S21	S12	∠S12	S22	∠S22
200	0.652	-152.6	22.719	111.2	0.024	50.4	0.545	-102.4
400	0.694	-168.0	12.745	95.1	0.034	54.6	0.466	-133.3
600	0.693	-174.1	8.865	86.6	0.045	58.6	0.442	-140.7
800	0.694	179.3	6.618	81.7	0.055	61.5	0.422	-149.5
1000	0.693	174.3	5.279	77.7	0.066	63.1	0.415	-154.8
1200	0.697	170.1	4.399	74.2	0.078	64.0	0.410	-159.2
1400	0.698	166.3	3.771	70.8	0.089	64.0	0.407	-162.2
1600	0.700	162.8	3.307	67.7	0.100	63.8	0.405	-165.0
1800	0.700	159.6	2.961	64.7	0.111	63.3	0.403	-167.1
2000	0.700	156.8	2.683	61.8	0.122	62.7	0.405	-169.1
2200	0.699	153.5	2.457	59.0	0.134	61.8	0.407	-170.8
2400	0.699	150.5	2.260	56.0	0.145	60.6	0.410	-172.2
2600	0.696	147.6	2.105	53.2	0.156	59.4	0.413	-173.6
2800	0.696	144.6	1.976	50.5	0.167	58.2	0.416	-174.4
3000	0.692	141.5	1.861	47.8	0.177	56.8	0.422	-175.4
3200	0.688	138.3	1.761	45.0	0.188	55.4	0.429	-175.9
3400	0.687	135.0	1.674	42.3	0.198	53.8	0.433	-176.3
3600	0.684	131.6	1.598	39.7	0.209	52.4	0.441	-176.5
3800	0.681	128.3	1.526	37.0	0.219	50.8	0.448	-176.6
4000	0.680	124.7	1.462	34.3	0.229	49.2	0.456	-176.6
4200	0.679	121.2	1.403	31.7	0.239	47.5	0.463	-176.6
4400	0.678	117.7	1.351	29.3	0.248	46.0	0.470	-176.4
4600	0.678	114.1	1.305	26.8	0.257	44.3	0.476	-176.2
4800	0.676	110.7	1.260	24.3	0.266	42.5	0.480	-176.1
5000	0.676	107.4	1.224	22.0	0.274	40.9	0.485	-176.0

# MCH4020

## S Parameters (Common emitter)

V<sub>CE</sub>=1V, I<sub>C</sub>=100mA

Freq(MHz)	S11	∠S11	S21	∠S21	S12	∠S12	S22	∠S22
200	0.797	-170.2	11.994	103.3	0.023	46.0	0.462	-142.7
400	0.821	-178.6	6.267	90.3	0.032	55.8	0.471	-159.7
600	0.814	176.9	4.334	82.5	0.044	60.5	0.456	-162.5
800	0.816	172.4	3.254	78.0	0.056	63.5	0.453	-167.1
1000	0.815	168.6	2.616	73.9	0.068	65.0	0.452	-169.7
1200	0.819	165.2	2.196	70.2	0.080	65.6	0.452	-172.2
1400	0.819	162.0	1.895	66.7	0.092	65.4	0.452	-173.8
1600	0.821	158.9	1.674	63.1	0.104	64.8	0.453	-175.5
1800	0.821	155.9	1.516	59.9	0.116	64.3	0.451	-177.0
2000	0.821	153.3	1.378	56.8	0.128	63.4	0.455	-178.3
2200	0.819	150.2	1.270	53.8	0.140	62.4	0.458	-179.4
2400	0.818	147.4	1.178	50.7	0.152	61.1	0.462	179.5
2600	0.815	144.6	1.107	47.7	0.164	59.7	0.464	178.3
2800	0.814	141.6	1.048	44.9	0.176	58.3	0.469	177.7
3000	0.809	138.5	0.995	42.2	0.187	56.9	0.475	176.9
3200	0.805	135.5	0.949	39.4	0.198	55.3	0.481	176.5
3400	0.803	132.2	0.909	36.7	0.209	53.8	0.486	176.1
3600	0.799	128.9	0.875	34.2	0.221	52.2	0.493	175.9
3800	0.796	125.6	0.842	31.6	0.232	50.5	0.499	175.7
4000	0.794	122.1	0.812	29.1	0.242	48.7	0.505	175.6
4200	0.792	118.7	0.785	26.7	0.252	47.0	0.511	175.6
4400	0.790	115.3	0.762	24.5	0.262	45.3	0.516	175.7
4600	0.788	111.8	0.743	22.3	0.272	43.4	0.519	175.8
4800	0.787	108.3	0.722	20.0	0.281	41.6	0.522	175.8
5000	0.785	105.1	0.707	17.9	0.290	39.9	0.525	175.8

V<sub>CE</sub>=3V, I<sub>C</sub>=10mA

Freq(MHz)	S11	∠S11	S21	∠S21	S12	∠S12	S22	∠S22
200	0.667	-73.4	19.421	137.2	0.036	59.5	0.807	-46.2
400	0.654	-117.7	13.670	112.4	0.051	46.8	0.610	-74.6
600	0.657	-137.3	10.173	99.3	0.060	43.7	0.541	-86.7
800	0.635	-152.0	7.684	90.5	0.066	43.4	0.452	-96.5
1000	0.624	-162.0	6.158	84.2	0.071	44.2	0.407	-104.3
1200	0.621	-169.6	5.138	79.1	0.076	45.7	0.376	-110.1
1400	0.620	-175.7	4.400	74.5	0.082	47.0	0.360	-114.7
1600	0.619	178.9	3.867	70.4	0.088	48.7	0.347	-119.0
1800	0.620	174.4	3.431	66.7	0.095	49.8	0.343	-122.2
2000	0.621	170.6	3.103	63.0	0.101	50.9	0.341	-125.5
2200	0.620	166.6	2.828	59.5	0.108	51.7	0.343	-128.1
2400	0.621	163.0	2.602	56.1	0.116	52.3	0.347	-130.7
2600	0.620	159.4	2.419	52.9	0.124	52.6	0.353	-133.3
2800	0.622	156.1	2.253	49.6	0.131	52.8	0.361	-135.1
3000	0.620	152.7	2.112	46.5	0.139	52.8	0.372	-137.1
3200	0.618	149.2	1.990	43.3	0.148	52.6	0.384	-138.9
3400	0.619	145.6	1.881	40.3	0.156	52.3	0.396	-140.4
3600	0.618	142.1	1.784	37.3	0.164	51.9	0.412	-141.7
3800	0.618	138.5	1.696	34.3	0.173	51.2	0.426	-143.0
4000	0.618	134.7	1.618	31.4	0.182	50.5	0.441	-144.1
4200	0.620	130.9	1.549	28.6	0.191	49.6	0.456	-145.3
4400	0.621	127.2	1.480	25.9	0.199	48.7	0.471	-146.2
4600	0.623	123.4	1.419	23.2	0.208	47.7	0.485	-147.0
4800	0.626	119.8	1.359	20.5	0.216	46.7	0.498	-147.7
5000	0.629	116.2	1.309	18.0	0.224	45.6	0.511	-148.5

# MCH4020

## S Parameters (Common emitter)

V<sub>CE</sub>=3V, I<sub>C</sub>=50mA

Freq(MHz)	S11	∠S11	S21	∠S21	S12	∠S12	S22	∠S22
200	0.516	-135.8	31.907	119.4	0.020	59.2	0.602	-73.9
400	0.593	-158.7	17.954	99.0	0.029	60.4	0.444	-104.5
600	0.602	-166.8	12.350	89.5	0.039	63.6	0.404	-113.3
800	0.606	-174.8	9.160	83.7	0.049	65.9	0.359	-123.7
1000	0.608	179.2	7.261	79.3	0.059	67.0	0.341	-131.0
1200	0.612	174.4	6.025	75.7	0.069	67.5	0.327	-136.6
1400	0.614	170.2	5.149	72.2	0.079	67.4	0.321	-140.6
1600	0.615	166.4	4.503	69.0	0.089	67.2	0.316	-144.0
1800	0.618	162.9	4.004	66.0	0.100	66.4	0.314	-146.9
2000	0.619	159.8	3.619	63.1	0.110	65.8	0.316	-149.3
2200	0.618	156.5	3.299	60.1	0.120	64.9	0.319	-151.3
2400	0.618	153.5	3.035	57.3	0.130	63.9	0.322	-152.9
2600	0.617	150.5	2.816	54.4	0.141	62.7	0.326	-154.5
2800	0.617	147.4	2.630	51.7	0.150	61.6	0.334	-155.5
3000	0.614	144.2	2.469	49.0	0.160	60.3	0.342	-156.7
3200	0.611	141.0	2.328	46.1	0.170	58.9	0.351	-157.4
3400	0.611	137.6	2.204	43.4	0.180	57.5	0.360	-157.9
3600	0.609	134.3	2.095	40.7	0.189	56.1	0.372	-158.3
3800	0.608	130.8	1.995	38.0	0.199	54.7	0.383	-158.6
4000	0.606	127.2	1.906	35.3	0.209	53.1	0.395	-158.7
4200	0.607	123.6	1.824	32.6	0.218	51.5	0.407	-158.8
4400	0.607	120.1	1.749	30.1	0.226	49.9	0.419	-158.9
4600	0.607	116.5	1.681	27.6	0.235	48.3	0.430	-158.8
4800	0.608	113.0	1.616	25.0	0.243	46.8	0.440	-158.9
5000	0.608	109.6	1.560	22.6	0.251	45.2	0.450	-159.0

V<sub>CE</sub>=3V, I<sub>C</sub>=100mA

Freq(MHz)	S11	∠S11	S21	∠S21	S12	∠S12	S22	∠S22
200	0.577	-155.5	28.271	114.9	0.017	60.5	0.496	-77.8
400	0.645	-169.1	15.432	96.4	0.025	64.9	0.367	-105.8
600	0.649	-174.6	10.567	87.2	0.036	68.7	0.339	-111.9
800	0.656	179.3	7.841	81.8	0.046	70.5	0.306	-121.4
1000	0.658	174.4	6.227	77.4	0.056	71.3	0.295	-127.8
1200	0.663	170.4	5.172	73.6	0.066	71.6	0.287	-132.7
1400	0.666	166.8	4.421	70.1	0.076	71.2	0.285	-136.0
1600	0.668	163.4	3.860	66.9	0.087	70.6	0.285	-138.9
1800	0.671	160.2	3.443	63.7	0.097	69.8	0.287	-141.5
2000	0.672	157.5	3.108	60.7	0.107	69.1	0.292	-143.6
2200	0.671	154.3	2.835	57.5	0.118	68.1	0.297	-145.5
2400	0.672	151.4	2.606	54.5	0.128	67.0	0.304	-147.0
2600	0.671	148.6	2.419	51.5	0.139	65.7	0.311	-148.5
2800	0.671	145.6	2.260	48.7	0.148	64.4	0.321	-149.6
3000	0.669	142.6	2.122	45.9	0.159	63.1	0.332	-150.9
3200	0.665	139.5	2.001	42.9	0.169	61.7	0.345	-151.7
3400	0.666	136.2	1.895	40.1	0.179	60.2	0.357	-152.5
3600	0.664	132.9	1.800	37.3	0.189	58.6	0.371	-153.0
3800	0.663	129.5	1.713	34.5	0.199	57.1	0.385	-153.6
4000	0.662	126.0	1.635	31.7	0.209	55.5	0.399	-154.0
4200	0.663	122.5	1.562	29.0	0.218	53.9	0.414	-154.4
4400	0.663	119.1	1.497	26.4	0.227	52.3	0.428	-154.8
4600	0.663	115.5	1.438	23.9	0.236	50.6	0.441	-155.0
4800	0.664	112.0	1.381	21.3	0.245	48.9	0.453	-155.3
5000	0.664	108.7	1.333	18.9	0.253	47.3	0.464	-155.7



# MCH4020

## S Parameters (Common emitter)

V<sub>CE</sub>=5V, I<sub>C</sub>=10mA

Freq(MHz)	S11	∠S11	S21	∠S21	S12	∠S12	S22	∠S22
200	0.674	-68.7	19.895	138.9	0.032	61.8	0.826	-41.4
400	0.653	-112.8	14.318	114.0	0.047	49.2	0.632	-67.8
600	0.651	-133.4	10.744	100.5	0.057	45.9	0.560	-79.3
800	0.626	-148.8	8.133	91.4	0.062	45.3	0.466	-88.2
1000	0.613	-159.3	6.522	84.8	0.067	46.0	0.415	-95.5
1200	0.610	-167.2	5.440	79.6	0.072	47.5	0.382	-100.9
1400	0.607	-173.5	4.659	74.9	0.078	48.7	0.363	-105.3
1600	0.606	-179.1	4.091	70.7	0.084	50.5	0.349	-109.4
1800	0.608	176.2	3.630	66.9	0.090	51.6	0.344	-112.7
2000	0.609	172.2	3.280	63.2	0.096	52.7	0.341	-116.0
2200	0.608	168.1	2.988	59.7	0.103	53.5	0.343	-118.8
2400	0.608	164.5	2.749	56.2	0.110	54.2	0.347	-121.6
2600	0.608	160.9	2.553	52.9	0.118	54.6	0.353	-124.4
2800	0.610	157.5	2.377	49.6	0.125	54.9	0.361	-126.4
3000	0.607	154.0	2.225	46.5	0.133	54.9	0.372	-128.8
3200	0.606	150.5	2.095	43.2	0.141	54.9	0.385	-130.8
3400	0.607	146.9	1.979	40.2	0.150	54.6	0.398	-132.6
3600	0.607	143.3	1.875	37.1	0.158	54.2	0.414	-134.3
3800	0.607	139.7	1.780	34.1	0.167	53.6	0.430	-136.0
4000	0.608	135.9	1.697	31.1	0.175	52.9	0.446	-137.4
4200	0.610	132.0	1.623	28.3	0.184	52.1	0.461	-138.8
4400	0.612	128.3	1.549	25.5	0.193	51.1	0.477	-140.0
4600	0.613	124.5	1.484	22.8	0.202	50.1	0.492	-141.1
4800	0.617	120.7	1.419	20.0	0.210	49.1	0.507	-142.0
5000	0.620	117.1	1.364	17.5	0.218	48.0	0.520	-143.0

V<sub>CE</sub>=5V, I<sub>C</sub>=50mA

Freq(MHz)	S11	∠S11	S21	∠S21	S12	∠S12	S22	∠S22
200	0.489	-128.9	33.664	121.6	0.019	61.0	0.625	-65.5
400	0.568	-154.7	19.269	100.2	0.028	61.3	0.449	-94.0
600	0.579	-163.6	13.271	90.3	0.038	64.6	0.404	-102.5
800	0.583	-172.3	9.829	84.2	0.047	66.7	0.350	-112.6
1000	0.584	-178.7	7.784	79.6	0.056	67.8	0.325	-119.9
1200	0.589	176.2	6.443	75.8	0.066	68.5	0.308	-125.6
1400	0.591	171.8	5.505	72.3	0.076	68.4	0.300	-129.7
1600	0.593	167.9	4.817	69.1	0.085	68.1	0.295	-133.2
1800	0.595	164.3	4.280	66.0	0.095	67.6	0.292	-136.3
2000	0.596	161.2	3.857	63.1	0.105	67.0	0.294	-138.9
2200	0.596	157.8	3.517	60.1	0.115	66.1	0.296	-141.1
2400	0.596	154.7	3.234	57.2	0.124	65.1	0.300	-142.9
2600	0.595	151.7	3.000	54.3	0.134	63.9	0.306	-144.7
2800	0.596	148.5	2.799	51.5	0.144	62.8	0.313	-145.9
3000	0.593	145.4	2.625	48.7	0.154	61.6	0.323	-147.3
3200	0.591	142.2	2.472	45.9	0.163	60.2	0.334	-148.3
3400	0.591	138.8	2.340	43.1	0.173	59.0	0.344	-149.0
3600	0.589	135.4	2.221	40.4	0.182	57.7	0.358	-149.6
3800	0.589	131.9	2.114	37.6	0.191	56.2	0.371	-150.2
4000	0.588	128.3	2.017	34.9	0.201	54.6	0.385	-150.6
4200	0.588	124.7	1.929	32.2	0.209	53.1	0.399	-150.9
4400	0.589	121.1	1.847	29.6	0.218	51.7	0.412	-151.3
4600	0.590	117.5	1.773	27.1	0.227	50.1	0.426	-151.5
4800	0.590	113.9	1.702	24.4	0.235	48.6	0.438	-151.7
5000	0.592	110.6	1.642	22.0	0.243	47.0	0.450	-152.0

# MCH4020

## Embossed Taping Specification

MCH4020-TL-H

### 1. Packing Format

Package Name	Carrier Tape Type	Maximum Number of devices contained (pcs)			Packing format	
		Reel	Inner box	Outer box	Inner BOX (C-1)	Outer BOX (A-7)
MCPH4	MCP4	3,000	15,000	90,000	5 reels contained Dimensions:mm (external) 183×72×185	6 inner boxes contained Dimensions:mm (external) 440×195×210

Reel label, Inner box label  
(unit: mm)

Outer box label  
It is a label at the time of factory shipments.  
The form of a label may change in physical distribution process.

#### Packing method

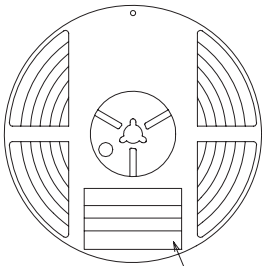

Type No.  
LOT No.  
Quantity  
Origin

Reel label

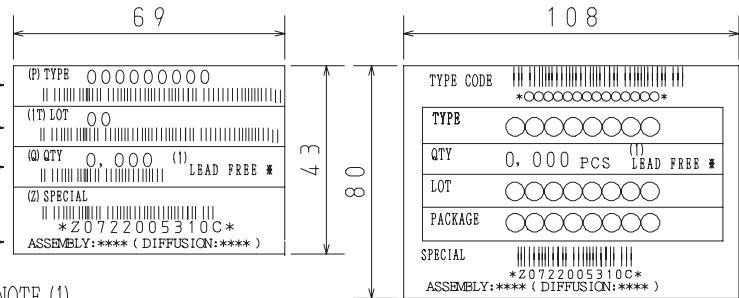

#### NOTE (1)

The LEAD FREE \* description shows that the surface treatment of the terminal is lead free.

Label	JEITA Phase
LEAD FREE 3	JEITA Phase 3A
LEAD FREE 4	JEITA Phase 3

### 2. Taping configuration

#### 2-1. Carrier tape size (unit:mm)

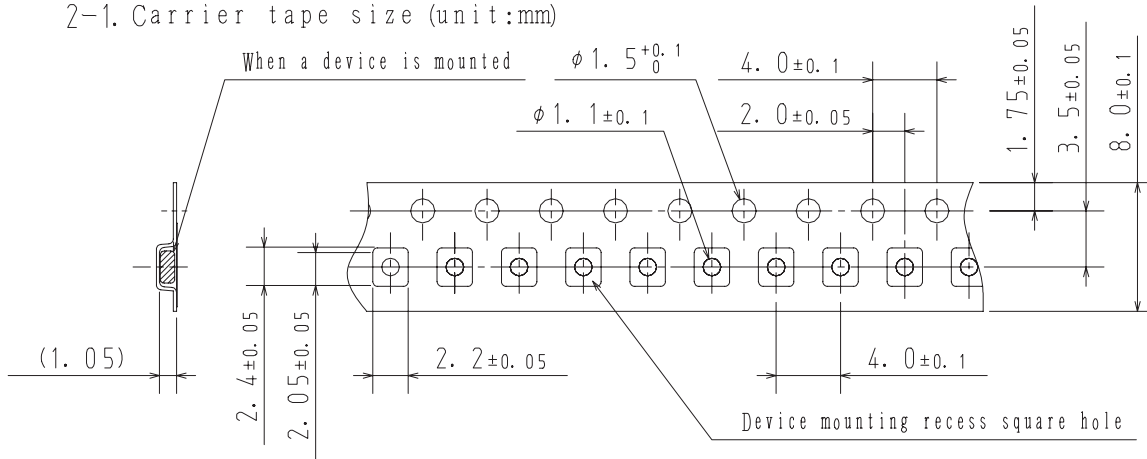

#### 2-2. Device placement direction

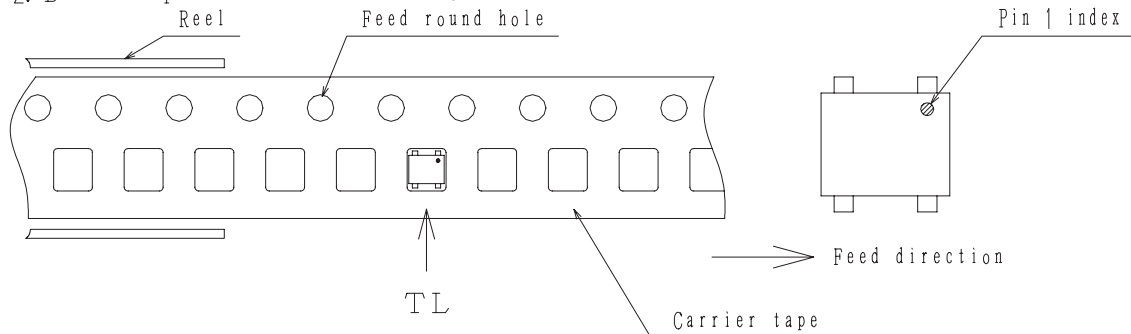

Those with pin 1 index on the feed hole side.....TL

# MCH4020

## Outline Drawing

MCH4020-TL-H

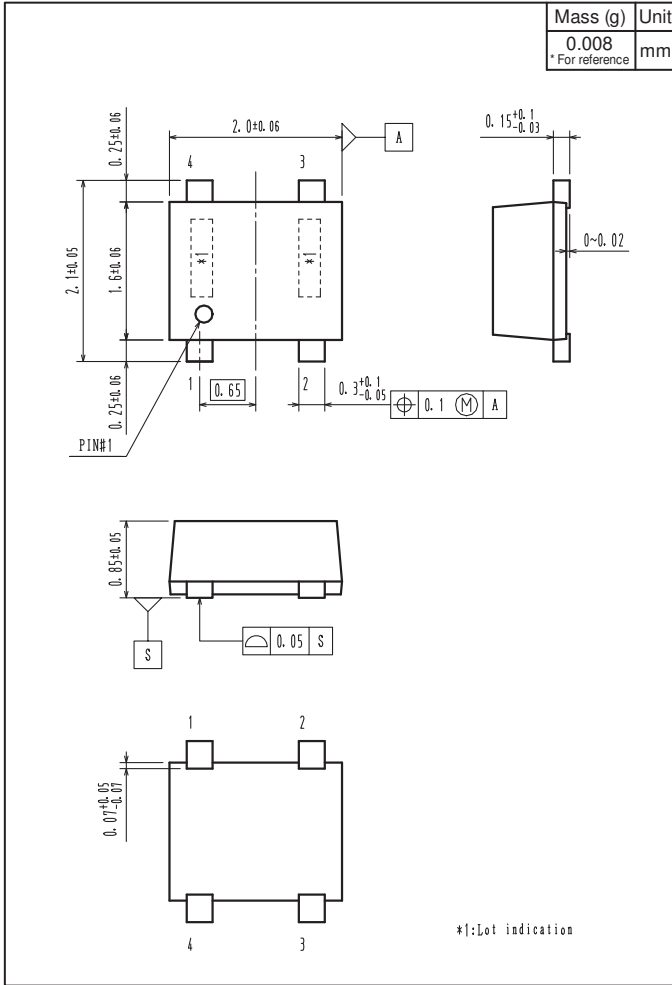

## Land Pattern Example

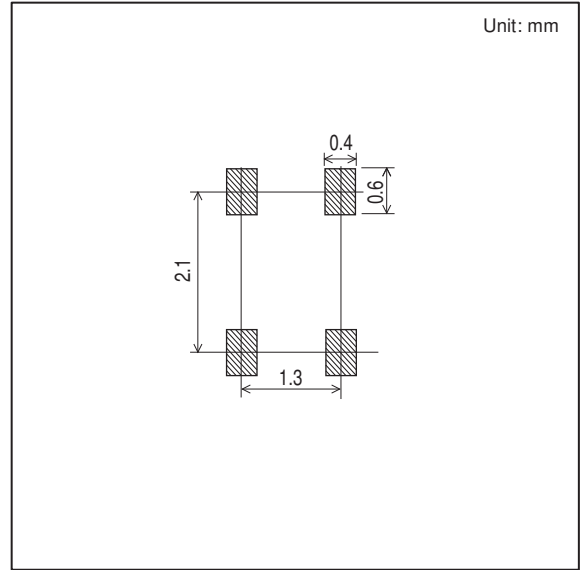

ON Semiconductor and the ON logo are registered trademarks of Semiconductor Components Industries, LLC (SCILLC). SCILLC owns the rights to a number of patents, trademarks, copyrights, trade secrets, and other intellectual property. A listing of SCILLC's product/patent coverage may be accessed at [www.onsemi.com/site/pdf/Patent-Marking.pdf](http://www.onsemi.com/site/pdf/Patent-Marking.pdf). SCILLC reserves the right to make changes without further notice to any products herein. SCILLC makes no warranty, representation or guarantee regarding the suitability of its products for any particular purpose, nor does SCILLC assume any liability arising out of the application or use of any product or circuit, and specifically disclaims any and all liability, including without limitation special, consequential or incidental damages. "Typical" parameters which may be provided in SCILLC data sheets and/or specifications can and do vary in different applications and actual performance may vary over time. All operating parameters, including "Typicals" must be validated for each customer application by customer's technical experts. SCILLC does not convey any license under its patent rights nor the rights of others. SCILLC products are not designed, intended, or authorized for use as components in systems intended for surgical implant into the body, or other applications intended to support or sustain life, or for any other application in which the failure of the SCILLC product could create a situation where personal injury or death may occur. Should Buyer purchase or use SCILLC products for any such unintended or unauthorized application, Buyer shall indemnify and hold SCILLC and its officers, employees, subsidiaries, affiliates, and distributors harmless against all claims, costs, damages, and expenses, and reasonable attorney fees arising out of, directly or indirectly, any claim of personal injury or death associated with such unintended or unauthorized use, even if such claim alleges that SCILLC was negligent regarding the design or manufacture of the part. SCILLC is an Equal Opportunity/Affirmative Action Employer. This literature is subject to all applicable copyright laws and is not for resale in any manner.