



Chipsmall Limited consists of a professional team with an average of over 10 year of expertise in the distribution of electronic components. Based in Hongkong, we have already established firm and mutual-benefit business relationships with customers from,Europe,America and south Asia,supplying obsolete and hard-to-find components to meet their specific needs.

With the principle of “Quality Parts,Customers Priority,Honest Operation,and Considerate Service”,our business mainly focus on the distribution of electronic components. Line cards we deal with include Microchip,ALPS,ROHM,Xilinx,Pulse,ON,Everlight and Freescale. Main products comprise IC,Modules,Potentiometer,IC Socket,Relay,Connector.Our parts cover such applications as commercial,industrial, and automotives areas.

We are looking forward to setting up business relationship with you and hope to provide you with the best service and solution. Let us make a better world for our industry!



Contact us

Tel: +86-755-8981 8866 Fax: +86-755-8427 6832

Email & Skype: info@chipsmall.com Web: www.chipsmall.com

Address: A1208, Overseas Decoration Building, #122 Zhenhua RD., Futian, Shenzhen, China





IMX35

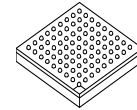

Package Information

Plastic Package
Case 5284 17 x 17 mm, 0.8 mm Pitch

i.MX35 Applications Processors for Automotive Products

Ordering Information

See [Table 1 on page 3](#) for ordering information.

1 Introduction

The i.MX35 Auto Application Processor family is designed for automotive infotainment and navigation applications. These processors are AECQ100 Grade 3 qualified and rated for ambient operating temperatures up to 85 °C.

Based on an ARM11 microprocessor core running at up to 532 MHz, the device offers the following features and optimized system cost for the target applications.

- Audio connectivity and telematics:
 - Compressed audio playback from storage devices (CD, USB, HDD or SD card)
 - PlayFromDevice (1-wire and 2-wire support) for portable media players
 - iPod/iPhone control and playback
 - High-speed CD ripping to USB, SD/MMC or HDD for virtual CD changer
 - Audio processing for hands-free telephony: Bluetooth, AEC/NS, and microphone beam forming
 - Speech recognition

1.	Introduction	1
1.1.	Features	2
1.2.	Ordering Information	3
1.3.	Block Diagram	5
2.	Functional Description and Application Information.	4
2.1.	Application Processor Domain Overview.	5
2.2.	Shared Domain Overview	6
2.3.	Advanced Power Management Overview	6
2.4.	ARM11 Microprocessor Core.	6
2.5.	Module Inventory	7
3.	Signal Descriptions: Special Function Related Pins	12
4.	Electrical Characteristics	13
4.1.	i.MX35 Chip-Level Conditions	13
4.2.	Power Modes	15
4.3.	Supply Power-Up/Power-Down Requirements and Restrictions	16
4.4.	Reset Timing	18
4.5.	Power Characteristics	19
4.6.	Thermal Characteristics	20
4.7.	I/O Pin DC Electrical Characteristics	21
4.8.	I/O Pin AC Electrical Characteristics	24
4.9.	Module-Level AC Electrical Specifications.	30
5.	Package Information and Pinout	131
5.1.	MAPBGA Production Package 1568-01, 17 × 17 mm, 0.8 Pitch.	132
5.2.	MAPBGA Signal Assignments.	133
6.	Product Documentation	145
7.	Revision History.	146



- A/V connectivity and navigation:
 - Includes audio connectivity and telematics features
 - Map display and route calculation
 - QVGA video decode, WVGA video display
 - Sophisticated graphical user interface

The i.MX35 processor takes advantage of the ARM1136JF-S™ core running at 532 MHz that is boosted by a multilevel cache system, and features peripheral devices such as an autonomous image processing unit, a vector floating point (VFP11) co-processor, and a RISC-based DMA controller.

The i.MX35 supports connections to various types of external memories, such as SDRAM, mobile DDR and DDR2, SLC and MLC NAND Flash, NOR Flash and SRAM. The device can be connected to a variety of external devices such as high-speed USB2.0 OTG, ATA, MMC/SDIO, and Compact Flash.

1.1 Features

The i.MX35 is designed for automotive infotainment video-enabled applications. It provides low-power solutions for applications demanding high-performance multimedia and graphics.

The i.MX35 is based on the ARM1136 platform, which has the following features:

- ARM1136JF-S processor, version r1p3
- 16-Kbyte L1 instruction cache
- 16-Kbyte L1 data cache
- 128-Kbyte L2 cache, version r0p4
- 128 Kbytes of internal SRAM
- Vector floating point unit (VFP11)

To boost multimedia performance, the following hardware accelerators are integrated:

- Image processing unit (IPU)
- OpenVG 1.1 graphics processing unit (GPU) (not available for the MCIMX351)

The MCIMX35 provides the following interfaces to external devices (some of these interfaces are muxed and not available simultaneously):

- 2 controller area network (CAN) interfaces
- 2 SDIO/MMC interfaces, 1 SDIO/CE-ATA interface (CE-ATA is not available for the MCIMX351)
- 32-bit mobile DDR, DDR2 (4-bank architecture), and SDRAM (up to 133 MHz)
- 2 configurable serial peripheral interfaces (CSPI) (up to 52 Mbps each)
- Enhanced serial audio interface (ESAI)
- 2 synchronous serial interfaces (SSI)
- Ethernet MAC 10/100 Mbps
- 1 USB 2.0 host with ULPI interface or internal full-speed PHY. Up to 480 Mbps if external HS PHY is used.
- 1 USB 2.0 OTG (up to 480 Mbps) controller with internal high-speed OTG PHY

- Flash controller—MLC/SLC NAND and NOR
- GPIO with interrupt capabilities
- 3 I²C modules (up to 400 Kbytes each)
- JTAG
- Key pin port
- Media local bus (MLB) interface
- Asynchronous sample rate converter (ASRC)
- 1-Wire
- Parallel camera sensor (4/8/10/16-bit data port for video color models: YCC, YUV, 30 Mpixels/s)
- Parallel display (primary up to 24-bit, 1024 x 1024)
- Parallel ATA (up to 66 Mbytes) (not available for the MCIMX351)
- PWM
- SPDIF transceiver
- 3 UART (up to 4.0 Mbps each)

1.2 Ordering Information

Table 1 provides the ordering information for the i.MX35 processors for automotive applications.

Table 1. Ordering Information

Description	Part Number	Silicon Revision	Package ¹	Speed	Operating Temperature Range (°C)	Signal Ball Map Locations	Ball Map
i.MX351	MCIMX351AVM4B	2.0	5284	400 MHz	–40 to 85	Table 94	Table 96
i.MX351	MCIMX351AVM5B	2.0	5284	532 MHz ²	–40 to 85	Table 94	Table 96
i.MX355	MCIMX355AVM4B	2.0	5284	400 MHz	–40 to 85	Table 94	Table 96
i.MX355	MCIMX355AVM5B	2.0	5284	532 MHz ²	–40 to 85	Table 94	Table 96
i.MX356	MCIMX356AVM4B	2.0	5284	400 MHz	–40 to 85	Table 94	Table 96
i.MX356	MCIMX356AVM5B	2.0	5284	532 MHz ²	–40 to 85	Table 94	Table 96
i.MX351	MCIMX351AJQ4C	2.1	5284	400MHz	-40 to 85	Table 95	Table 97
i.MX351	MCIMX351AJQ5C	2.1	5284	532MHz ²	-40 to 85	Table 95	Table 97
i.MX355	MCIMX355AJQ4C	2.1	5284	400MHz	-40 to 85	Table 95	Table 97
i.MX355	MCIMX355AJQ5C	2.1	5284	532MHz ²	-40 to 85	Table 95	Table 97
i.MX356	MCIMX356AJQ4C	2.1	5284	400MHz	-40 to 85	Table 95	Table 97
i.MX356	MCIMX356AJQ5C	2.1	5284	532MHz ²	-40 to 85	Table 95	Table 97
i.MX356	SCIMX356BVMB	2	5284	532MHz	-40 to 85	Table 94	Table 96

¹ Case 5284 is RoHS-compliant, lead-free, MSL = 3, 1.

² 532 MHz rated devices meet all specifications of 400 MHz rated devices. A 532 MHz device can be substituted in place of a 400 MHz device.

The ball map for silicon revision 2.1 is different than the ballmap for silicon revision 2.0. The layout for each revision is not compatible, so it is important that the correct ballmap be used to implement the layout. See [Section 5, “Package Information and Pinout.”](#)

Table 2 shows the functional differences between the different parts in the i.MX35 family.

Table 2. Functional Differences in the i.MX35 Parts

Module	MCIMX351	MCIMX353	MCIMX355	MCIMX356	MCIMX357
I2C (3)	Yes	Yes	Yes	Yes	Yes
CSPI (2)	Yes	Yes	Yes	Yes	Yes
SSI/I2S (2)	Yes	Yes	Yes	Yes	Yes
ESAI	Yes	Yes	Yes	Yes	Yes
SPDIF I/O	Yes	Yes	Yes	Yes	Yes
USB HS Host	Yes	Yes	Yes	Yes	Yes
USB OTG	Yes	Yes	Yes	Yes	Yes
FlexCAN (2)	Yes	Yes	Yes	Yes	Yes
MLB	Yes	Yes	Yes	Yes	Yes
Ethernet	Yes	Yes	Yes	Yes	Yes
1-Wire	Yes	Yes	Yes	Yes	Yes
KPP	Yes	Yes	Yes	Yes	Yes
SDIO/MMC (2)	Yes	Yes	Yes	Yes	Yes
SDIO/Memory Stick	Yes	Yes	Yes	Yes	Yes
External Memory Controller (EMC)	Yes	Yes	Yes	Yes	Yes
JTAG	Yes	Yes	Yes	Yes	Yes
PATA	—	Yes	Yes	Yes	Yes
CE-ATA	—	Yes	Yes	Yes	Yes
Image Processing Unit (IPU) (inversion and rotation, pre- and post-processing, camera interface, blending, display controller)	—	Yes	Yes	Yes	Yes
Open VG graphics acceleration (GPU)	—	Yes	—	Yes	Yes

1.3 Block Diagram

Figure 1 is the i.MX35 simplified interface block diagram.

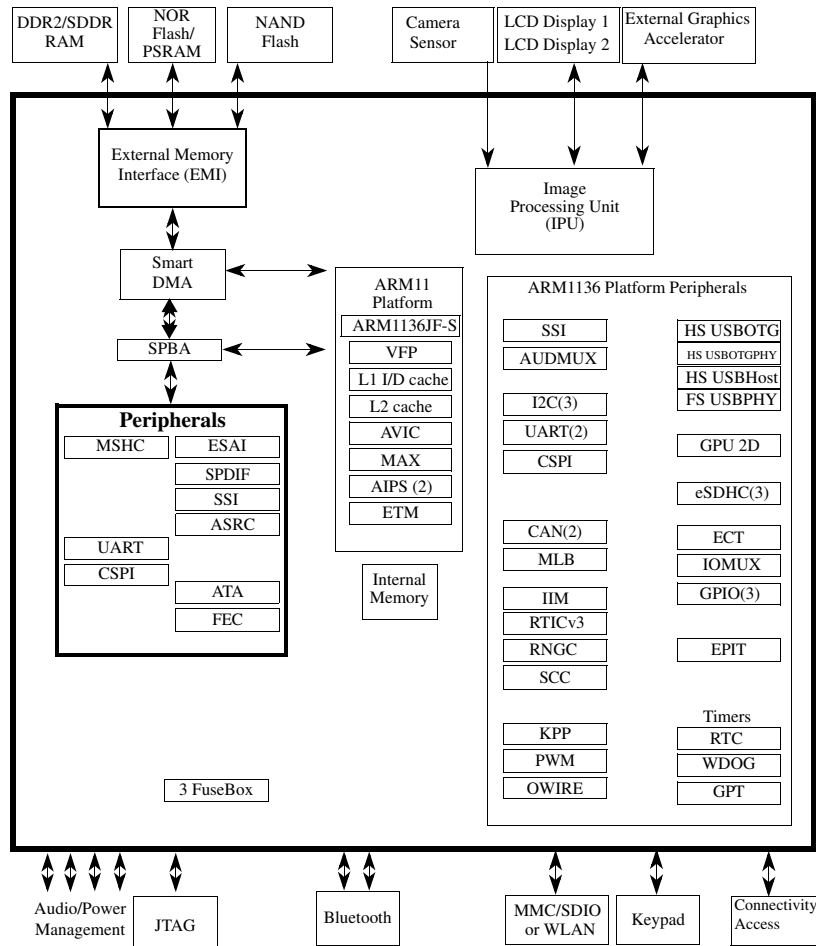

Figure 1. i.MX35 Simplified Interface Block Diagram

2 Functional Description and Application Information

The i.MX35 consists of the following major subsystems:

- ARM1136 Platform—AP domain
- SDMA Platform and EMI—Shared domain

2.1 Application Processor Domain Overview

The applications processor (AP) and its domain are responsible for running the operating system and applications software, providing the user interface, and supplying access to integrated and external peripherals. The AP domain is built around an ARM1136JF-S core with 16-Kbyte instruction and data L1 caches, an MMU, a 128-Kbyte L2 cache, a multiported crossbar switch, and advanced debug and trace interfaces.

The i.MX35 core is intended to operate at a maximum frequency of 532 MHz to support the required multimedia use cases. Furthermore, an image processing unit (IPU) is integrated into the AP domain to offload the ARM11 core from performing functions such as color space conversion, image rotation and scaling, graphics overlay, and pre- and post-processing.

The functionality of AP Domain peripherals includes the user interface; the connectivity, display, security, and memory interfaces; and 128 Kbytes of multipurpose SRAM.

2.2 Shared Domain Overview

The shared domain is composed of the shared peripherals, a smart DMA engine (SDMA) and a number of miscellaneous modules. For maximum flexibility, some peripherals are directly accessible by the SDMA engine.

The i.MX35 has a hierarchical memory architecture including L1 caches and a unified L2 cache. This reduces the bandwidth demands for the external bus and external memory. The external memory subsystem supports a flexible external memory system, including support for SDRAM (SDR, DDR2 and mobile DDR) and NAND Flash.

2.3 Advanced Power Management Overview

To address the continuing need to reduce power consumption, the following techniques are incorporated in the i.MX35:

- Clock gating
- Power gating
- Power-optimized synthesis
- Well biasing

The insertion of gating into the clock paths allows unused portions of the chip to be disabled. Because static CMOS logic consumes only leakage power, significant power savings can be realized.

“Well biasing” is applying a voltage that is greater than V_{DD} to the nwells, and one that is lower than V_{SS} to the pwells. The effect of applying this well back bias voltage reduces the subthreshold channel leakage. For the 90-nm digital process, it is estimated that the subthreshold leakage is reduced by a factor of ten over the nominal leakage. Additionally, the supply voltage for internal logic can be reduced from 1.4 V to 1.22 V.

2.4 ARM11 Microprocessor Core

The CPU of the i.MX35 is the ARM1136JF-S core, based on the ARM v6 architecture. This core supports the ARM Thumb[®] instruction sets, features Jazelle[®] technology (which enables direct execution of Java byte codes) and a range of SIMD DSP instructions that operate on 16-bit or 8-bit data values in 32-bit registers.

The ARM1136JF-S processor core features are as follows:

- Integer unit with integral EmbeddedICE[™] logic
- Eight-stage pipeline

- Branch prediction with return stack
- Low-interrupt latency
- Instruction and data memory management units (MMUs), managed using micro TLB structures backed by a unified main TLB
- Instruction and data L1 caches, including a non-blocking data cache with hit-under-miss
- Virtually indexed/physically addressed L1 caches
- 64-bit interface to both L1 caches
- Write buffer (bypassable)
- High-speed Advanced Micro Bus Architecture (AMBA)[™] L2 interface
- Vector floating point co-processor (VFP) for 3D graphics and hardware acceleration of other floating-point applications
- ETM[™] and JTAG-based debug support

Table 3 summarizes information about the i.MX35 core.

Table 3. i.MX35 Core

Core Acronym	Core Name	Brief Description	Integrated Memory Features
ARM11 or ARM1136	ARM1136 Platform	The ARM1136 [™] platform consists of the ARM1136JF-S core, the ETM real-time debug modules, a 6 × 5 multi-layer AHB crossbar switch (MAX), and a vector floating processor (VFP). The i.MX35 provides a high-performance ARM11 microprocessor core and highly integrated system functions. The ARM Application Processor (AP) and other subsystems address the needs of the personal, wireless, and portable product market with integrated peripherals, advanced processor core, and power management capabilities.	<ul style="list-style-type: none"> • 16-Kbyte instruction cache • 16-Kbyte data cache • 128-Kbyte L2 cache • 32-Kbyte ROM • 128-Kbyte RAM

2.5 Module Inventory

Table 4 shows an alphabetical listing of the modules in the MCIMX35. For extended descriptions of the modules, see the MCIMX35 reference manual.

Table 4. Digital and Analog Modules

Block Mnemonic	Block Name	Domain ¹	Subsystem	Brief Description
1-WIRE	1-Wire interface	ARM	ARM1136 platform peripherals	1-Wire provides the communication line to a 1-Kbit add-only memory. the interface can send or receive 1 bit at a time.
ASRC	Asynchronous sample rate converter	SDMA	Connectivity peripherals	The ASRC is designed to convert the sampling rate of a signal associated to an input clock into a signal associated to a different output clock. It supports a concurrent sample rate conversion of about –120 dB THD+N. The sample rate conversion of each channel is associated to a pair of incoming and outgoing sampling rates.

Table 4. Digital and Analog Modules (continued)

Block Mnemonic	Block Name	Domain ¹	Subsystem	Brief Description
ATA	ATA module	SDMA	Connectivity peripherals	The ATA block is an AT attachment host interface. Its main use is to interface with IDE hard disk drives and ATAPI optical disk drives. It interfaces with the ATA device over a number of ATA signals.
AUDMUX	Digital audio mux	ARM	Multimedia peripherals	The AUDMUX is a programmable interconnect for voice, audio, and synchronous data routing between host serial interfaces (SSIs) and peripheral serial interfaces (audio codecs). The AUDMUX has two sets of interfaces: internal ports to on-chip peripherals and external ports to off-chip audio devices. Data is routed by configuring the appropriate internal and external ports.
CAN(2)	CAN module	ARM	Connectivity peripherals	The CAN protocol is primarily designed to be used as a vehicle serial data bus running at 1 Mbps.
CCM	Clock control module	ARM	Clocks	This block generates all clocks for the peripherals in the SDMA platform. The CCM also manages ARM1136 platform low-power modes (WAIT, STOP), disabling peripheral clocks appropriately for power conservation, and provides alternate clock sources for the ARM1136 and SDMA platforms.
CSPI(2)	Configurable serial peripheral interface	SDMA, ARM	Connectivity peripherals	This module is a serial interface equipped with data FIFOs; each master/slave-configurable SPI module is capable of interfacing to both serial port interface master and slave devices. The CSPI ready (SPI_RDY) and slave select (SS) control signals enable fast data communication with fewer software interrupts.
ECT	Embedded cross trigger	SDMA, ARM	Debug	ECT (embedded cross trigger) is an IP for real-time debug purposes. It is a programmable matrix allowing several subsystems to interact with each other. ECT receives signals required for debugging purposes (from cores, peripherals, buses, external inputs, and so on) and propagates them (propagation programmed through software) to the different debug resources available within the SoC.
EMI	External memory interface	SDMA	External memory interface	The EMI module provides access to external memory for the ARM and other masters. It is composed of the following main submodules: M3IF—provides arbitration between multiple masters requesting access to the external memory. SDRAM CTRL—interfaces to mDDR, DDR2 (4-bank architecture type), and SDR interfaces. NANDFC—provides an interface to NAND Flash memories. WEIM—interfaces to NOR Flash and PSRAM.
EPIT(2)	Enhanced periodic interrupt timer	ARM	Timer peripherals	Each EPIT is a 32-bit “set-and-forget” timer that starts counting after the EPIT is enabled by software. It is capable of providing precise interrupts at regular intervals with minimal processor intervention. It has a 12-bit prescaler to adjust the input clock frequency to the required time setting for the interrupts, and the counter value can be programmed on the fly.

Table 4. Digital and Analog Modules (continued)

Block Mnemonic	Block Name	Domain ¹	Subsystem	Brief Description
ESAI	Enhanced serial audio interface	SDMA	Connectivity peripherals	The enhanced serial audio interface (ESAI) provides a full-duplex serial port for serial communication with a variety of serial devices, including industry-standard codecs, SPDIF transceivers, and other DSPs. The ESAI consists of independent transmitter and receiver sections, each section with its own clock generator.
eSDHCv2 (3)	Enhanced secure digital host controller	ARM	Connectivity peripherals	The eSDHCv2 consists of four main modules: CE-ATA, MMC, SD and SDIO. CE-ATA is a hard drive interface that is optimized for embedded applications of storage. The MultiMediaCard (MMC) is a universal, low-cost, data storage and communication media to applications such as electronic toys, organizers, PDAs, and smart phones. The secure digital (SD) card is an evolution of MMC and is specifically designed to meet the security, capacity, performance, and environment requirements inherent in emerging audio and video consumer electronic devices. SD cards are categorized into Memory and I/O. A memory card enables a copyright protection mechanism that complies with the SDMI security standard. SDIO cards provide high-speed data I/O (such as wireless LAN via SDIO interface) with low power consumption. Note: CE-ATA is not available for the MCIMX351.
FEC	Ethernet	SDMA	Connectivity peripherals	The Ethernet media access controller (MAC) is designed to support both 10 and 100 Mbps Ethernet/IEEE 802.3 networks. An external transceiver interface and transceiver function are required to complete the interface to the media
GPIO(3)	General purpose I/O modules	ARM	Pins	Used for general purpose input/output to external ICs. Each GPIO module supports 32 bits of I/O.
GPT	General purpose timers	ARM	Timer peripherals	Each GPT is a 32-bit free-running or set-and-forget mode timer with a programmable prescaler and compare and capture registers. A timer counter value can be captured using an external event and can be configured to trigger a capture event on either the leading or trailing edges of an input pulse. When the timer is configured to operate in set-and-forget mode, it is capable of providing precise interrupts at regular intervals with minimal processor intervention. The counter has output compare logic to provide the status and interrupt at comparison. This timer can be configured to run either on an external clock or on an internal clock.
GPU2D	Graphics processing unit 2Dv1	ARM	Multimedia peripherals	This module accelerates OpenVG and GDI graphics. Note: Not available for the MCIMX351.

Table 4. Digital and Analog Modules (continued)

Block Mnemonic	Block Name	Domain ¹	Subsystem	Brief Description
I ² C(3)	I ² C module	ARM	ARM1136 platform peripherals	Inter-integrated circuit (I ² C) is an industry-standard, bidirectional serial bus that provides a simple, efficient method of data exchange, minimizing the interconnection between devices. I ² C is suitable for applications requiring occasional communications over a short distance among many devices. The interface operates at up to 100 kbps with maximum bus loading and timing. The I ² C system is a true multiple-master bus, with arbitration and collision detection that prevent data corruption if multiple devices attempt to control the bus simultaneously. This feature supports complex applications with multiprocessor control and can be used for rapid testing and alignment of end products through external connections to an assembly-line computer.
IIM	IC identification module	ARM	Security modules	The IIM provides the primary user-visible mechanism for interfacing with on-chip fuse elements. Among the uses for the fuses are unique chip identifiers, mask revision numbers, cryptographic keys, and various control signals requiring a fixed value.
IOMUX	External signals and pin multiplexing	ARM	Pins	Each I/O multiplexer provides a flexible, scalable multiplexing solution with the following features: <ul style="list-style-type: none"> • Up to eight output sources multiplexed per pin • Up to four destinations for each input pin • Unselected input paths held at constant levels for reduced power consumption
IPUv1	Image processing unit	ARM	Multimedia peripherals	The IPU supports video and graphics processing functions. It also provides the interface for image sensors and displays. The IPU performs the following main functions: <ul style="list-style-type: none"> • Preprocessing of data from the sensor or from the external system memory • Postprocessing of data from the external system memory • Post-filtering of data from the system memory with support of the MPEG-4 (both deblocking and deringing) and H.264 post-filtering algorithms • Displaying video and graphics on a synchronous (dumb or memory-less) display • Displaying video and graphics on an asynchronous (smart) display • Transferring data between IPU sub-modules and to/from the system memory with flexible pixel reformatting
KPP	Keypin port	ARM	Connectivity peripherals	Can be used for either keypin matrix scanning or general purpose I/O.
MLB	Media local bus	ARM	Connectivity peripherals	The MLB is designed to interface to an automotive MOST ring.
OSCAUD	OSC audio reference oscillator	Analog	Clock	The OSCAUDIO oscillator provides a stable frequency reference for the PLLs. This oscillator is designed to work in conjunction with an external 24.576-MHz crystal.

Table 4. Digital and Analog Modules (continued)

Block Mnemonic	Block Name	Domain ¹	Subsystem	Brief Description
OSC24M	OSC24M 24-MHz reference oscillator	Analog	Clock	The signal from the external 24-MHz crystal is the source of the CLK24M signal fed into USB PHY as the reference clock and to the real time clock (RTC).
MPLL PPLL	Digital phase-locked loops	SDMA	Clocks	DPLLs are used to generate the clocks: MCU PLL (MPLL)—programmable Peripheral PLL (PPLL)—programmable
PWM	Pulse-width modulator	ARM	ARM1136 platform peripherals	The pulse-width modulator (PWM) is optimized to generate sound from stored sample audio images; it can also generate tones.
RTC	Real-time clock	ARM	Clocks	Provides the ARM1136 platform with a clock function (days, hours, minutes, seconds) and includes alarm, sampling timer, and minute stopwatch capabilities.
SDMA	Smart DMA engine	SDMA	System controls	The SDMA provides DMA capabilities inside the processor. It is a shared module that implements 32 DMA channels and has an interface to connect to the ARM1136 platform subsystem, EMI interface, and the peripherals.
SJC	Secure JTAG controller	ARM	Pins	The secure JTAG controller (SJC) provides debug and test control with maximum security.
SPBA	SDMA peripheral bus arbiter	SDMA	System controls	The SPBA controls access to the SDMA peripherals. It supports shared peripheral ownership and access rights to an owned peripheral.
S/PDIF	Serial audio interface	SDMA	Connectivity peripherals	Sony/Philips digital transceiver interface
SSI(2)	Synchronous serial interface	SDMA, ARM(2)	Connectivity peripherals	The SSI is a full-duplex serial port that allows the processor connected to it to communicate with a variety of serial protocols, including the Freescale Semiconductor SPI standard and the I ² C sound (I ² S) bus standard. The SSIs interface to the AUDMUX for flexible audio routing.
UART(3)	Universal asynchronous receiver/transmitters	ARM (UART1,2) SDMA (UART3)	Connectivity peripherals	Each UART provides serial communication capability with external devices through an RS-232 cable using the standard RS-232 non-return-to-zero (NRZ) encoding format. Each module transmits and receives characters containing either 7 or 8 bits (program-selectable). Each UART can also provide low-speed IrDA compatibility through the use of external circuitry that converts infrared signals to electrical signals (for reception) or transforms electrical signals to signals that drive an infrared LED (for transmission).

Table 4. Digital and Analog Modules (continued)

Block Mnemonic	Block Name	Domain ¹	Subsystem	Brief Description
USBOH	High-speed USB on-the-go	SDMA	Connectivity peripherals	The USB module provides high performance USB on-the-go (OTG) functionality (up to 480 Mbps), compliant with the USB 2.0 specification, the OTG supplement, and the ULPI 1.0 low pin count specification. The module has DMA capabilities handling data transfer between internal buffers and system memory.
WDOG	Watchdog modules	ARM	Timer peripherals	Each module protects against system failures by providing a method of escaping from unexpected events or programming errors. Once activated, the timer must be serviced by software on a periodic basis. If servicing does not take place, the watchdog times out and then either asserts a system reset signal or an interrupt request signal, depending on the software configuration.

¹ ARM = ARM1136 platform, SDMA = SDMA platform

3 Signal Descriptions: Special Function Related Pins

Some special functional requirements are supported in the device. The details about these special functions and the corresponding pin names are listed in [Table 5](#).

Table 5. Special Function Related Pins

Function Name	Pin Name	Mux Mode	Detailed Description
External ARM Clock	EXT_ARMCLK	ALT0	External clock input for ARM clock.
External Peripheral Clock	I2C1_CLK	ALT6	External peripheral clock source.
External 32-kHz Clock	CAPTURE	ALT4	External clock input of 32 kHz, used when the internal 24M Oscillator is powered off, which could be configured either from CAPTURE or CSPI1_SS1.
	CSPI1_SS1	ALT2	
Clock Out	CLKO	ALT0	Clock-out pin from CCM, clock source is controllable and can also be used for debug.
Power Ready	GPIO1_0	ALT1	PMIC power-ready signal, which can be configured either from GPIO1_0 or TX1.
	TX1	ALT1	
Tamper Detect	GPIO1_1	ALT6	Tamper-detect logic is used to issue a security violation. This logic is activated if the tamper-detect input is asserted. Tamper-detect logic is enabled by the bit of IOMUXC_GPRA[2]. After enabling the logic, it is impossible to disable it until the next reset.

4 Electrical Characteristics

The following sections provide the device-level and module-level electrical characteristics for the i.MX35 processor.

4.1 i.MX35 Chip-Level Conditions

This section provides the device-level electrical characteristics for the IC. See [Table 6](#) for a quick reference to the individual tables and sections.

Table 6. i.MX35 Chip-Level Conditions

Characteristics	Table/Location
Absolute Maximum Ratings	Table 7 on page 13
i.MX35 Operating Ranges	Table 8 on page 14
Interface Frequency	Table 9 on page 15

CAUTION

Stresses beyond those listed in [Table 7](#) may cause permanent damage to the device. These are stress ratings only. Functional operation of the device at these or any other conditions beyond those indicated in [Table 8](#) is not implied. Exposure to absolute-maximum-rated conditions for extended periods may affect device reliability.

Table 7. Absolute Maximum Ratings

Parameter	Symbol	Min.	Max.	Units
Supply voltage (core)	$V_{DD_{max}}$ ¹	-0.5	1.47	V
Supply voltage (I/O)	$NVCC_{max}$	-0.5	3.6	V
Input voltage range	$V_{I_{max}}$	-0.5	3.6	V
Storage temperature	$T_{storage}$	-40	125	°C
ESD damage immunity:	V_{esd}			V
Human Body Model (HBM)		—	2000 ²	
Charge Device Model (CDM)		—	500 ³	

¹ VDD is also known as QVCC.

² HBM ESD classification level according to the AEC-Q100-002 standard

³ Corner pins max. 750 V

4.1.1 i.MX35 Operating Ranges

Table 8 provides the recommended operating ranges. The term NVCC in this section refers to the associated supply rail of an input or output.

Table 8. i.MX35 Operating Ranges

Parameter	Symbol	Min.	Typical	Max.	Units
Core Operating Voltage 0 < f _{ARM} < 400 MHz	V _{DD}	1.22	—	1.47	V
Core Operating Voltage 0 < f _{ARM} < 532 MHz		1.33	—	1.47	V
State Retention Voltage		1	—	—	V
EMI ¹	NVCC_EMI1,2,3	1.7	—	3.6	V
WTDG, Timer, CCM, CSPI1	NVCC_CRM	1.75	—	3.6	V
NANDF	NVCC_NANDF	1.75	—	3.6	V
ATA, USB generic	NVCC_ATA	1.75	—	3.6	V
eSDHC1	NVCC_SDIO	1.75	—	3.6	V
CSI, SDIO2	NVCC_CSI	1.75	—	3.6	V
JTAG	NVCC_JTAG	1.75	—	3.6	V
LCDC, TTM, I2C1	NVCC_LCDC	1.75	—	3.6	V
I2Sx2, ESAI, I2C2, UART2, UART1, FEC	NVCC_MISC	1.75	—	3.6	V
MLB	NVCC_MLB ²	1.75	—	3.6	V
USB OTG PHY	PHY1_VDDA	3.17	3.3	3.43	V
USB OTG PHY	USBPHY1_VDDA_BIAS	3.17	3.3	3.43	V
USB OTG PHY	USBPHY1_UPLLVDD	3.17	3.3	3.43	V
USB HOST PHY	PHY2_VDD	3.0	3.3	3.6	V
OSC24M	OSC24M_VDD	3.0	3.3	3.6	V
OSC_AUDIO	OSC_AUDIO_VDD	3.0	3.3	3.6	V
MPLL	MVDD	1.4	—	1.65	V
PPLL	PVDD	1.4	—	1.65	V
Fusebox program supply voltage	FUSE_VDD ³	3.0	3.6	3.6	V
Operating ambient temperature range	T _A	-40	—	85	°C
Junction temperature range	T _J	-40	—	105	°C

¹ EMI I/O interface power supply should be set up according to external memory. For example, if using SDRAM then NVCC_EMI1,2,3 should all be set at 3.3 V (typ.). If using MDDR or DDR2, NVCC_EMI1,2,3 must be set at 1.8 V (typ.).

² MLB interface I/O pads can be programmed to function as GPIO by setting NVCC_MLB to 1.8 or 3.3 V, but if used as MLB pads, NVCC_MLB must be set to 2.5 V in order to be compliant with external MOST devices. NVCC_MLB may be left floating.

³ The Fusebox read supply is connected to supply of the full speed USB PHY. FUSE_VDD is only used for programming. It is recommended that FUSE_VDD be connected to ground when not being used for programming. FUSE_VDD should be supplied by following the power up sequence given in Section 4.3.1, "Powering Up."

4.1.2 Interface Frequency Limits

Table 9 provides information on interface frequency limits.

Table 9. Interface Frequency

ID	Parameter	Symbol	Min.	Typ.	Max.	Units
1	JTAG TCK Frequency	f_{JTAG}	DC	5	10	MHz

4.2 Power Modes

Table 10 provides descriptions of the power modes of the i.MX35 processor.

Table 10. i.MX35 Power Modes

Power Mode	Description	QVCC (ARM/L2 Peripheral)		MVDD/PVDD		OSC24M_VDD OSC_AUDIO_VDD	
		Typ.	Max.	Typ.	Max.	Typ.	Max.
Wait	VDD1,2,3,4 = 1.1 V (min.) ARM is in wait for interrupt mode. MAX is active. L2 cache is kept powered. MCU PLL is on (400 MHz) PER PLL is off (can be configured) (default: 300 MHz) Module clocks are gated off (can be configured by CGR register). OSC 24M is ON. OSC audio is off (can be configured). RNGC internal osc is off.	16 mA	170 mA	7.2 mA	14 mA	1.2 mA	3 mA
Doze	VDD1,2,3,4 = 1.1 V (min.) ARM is in wait for interrupt mode. MAX is halted. L2 cache is kept powered. L2 cache control logic off. AWB enabled. MCU PLL is on(400 MHz) PER PLL is off (can be configured). (300 Mhz). Module clocks are gated off (can be configured by CGR register). OSC 24M is ON. OSC audio is off (can be configured) RNGC internal osc is off	12.4 mA	105 mA	7.2 mA	14 mA	1.2 mA	3 mA

Table 10. i.MX35 Power Modes (continued)

Power Mode	Description	QVCC (ARM/L2 Peripheral)		MVDD/PVDD		OSC24M_VDD OSC_AUDIO_VDD	
		Typ.	Max.	Typ.	Max.	Typ.	Max.
Stop	VDD1,2,3,4 = 1.1 V (min.) ARM is in wait for interrupt mode. MAX is halted L2 cache is kept powered. L2 cache control logic off. AWB enabled. MCU PLL is off. PER PLL is off. All clocks are gated off. OSC 24 MHz is on OSC audio is off RNGC internal osc is off	1.1 mA	77 mA	400 µA	2.2 mA	1.2 mA	2.2 mA
Static	VDD1,2,3,4 = 1.1 V (min.) ARM is in wait for interrupt mode. MAX is halted L2 cache is kept powered. L2 cache control logic off. AWB enabled. MCU PLL is off. PER PLL is off. All clocks are gated off. OSC 24MHz is on OSC audio is off RNGC internal osc is off	820 µA	72 mA	50 µA	1.7 mA	24 µA	35 µA
Note: Typical column: TA = 25 °C Note: Maximum column: TA = 85 °C							

4.3 Supply Power-Up/Power-Down Requirements and Restrictions

This section provides power-up and power-down sequence guidelines for the i.MX35 processor.

CAUTION

Any i.MX35 board design must comply with the power-up and power-down sequence guidelines as described in this section to guarantee reliable operation of the device. Any deviation from these sequences can result in irreversible damage to the i.MX35 processor (worst-case scenario).

NOTE

Deviation from these sequences may also result in one or more of the following:

- Excessive current during power-up phase
- Prevent the device from booting
- Programming of unprogrammed fuses

4.3.1 Powering Up

The power-up sequence should be completed as follows:

1. Assert Power on Reset ($\overline{\text{POR}}$).
2. Turn on digital logic domain and IO power supply: VDD_n , NVCC_x
3. Wait until VDD_n and NVCC_x power supplies are stable + 32 μs .
4. Turn on all other power supplies: PHY1_VDDA , USBPHY1_VDDA_BIAS , PHY2_VDD , USBPHY1_UPLLVD , OSC24M_VDD , OSC_AUDIO_VDD , MVDD , PVDD , FUSEVDD . (Always FUSE_VDD should be connected to ground, except when eFuses are to be programmed.)
5. Wait until PHY1_VDDA , USBPHY1_VDDA_BIAS , PHY2_VDD , USBPHY1_UPLLVD , OSC24M_VDD , OSC_AUDIO_VDD , MVDD , PVDD , (FUSEVDD , optional). Power supplies are stable + 100 μs .
6. Deassert the $\overline{\text{POR}}$ signal.

Figure 2 shows the power-up sequence and timing.

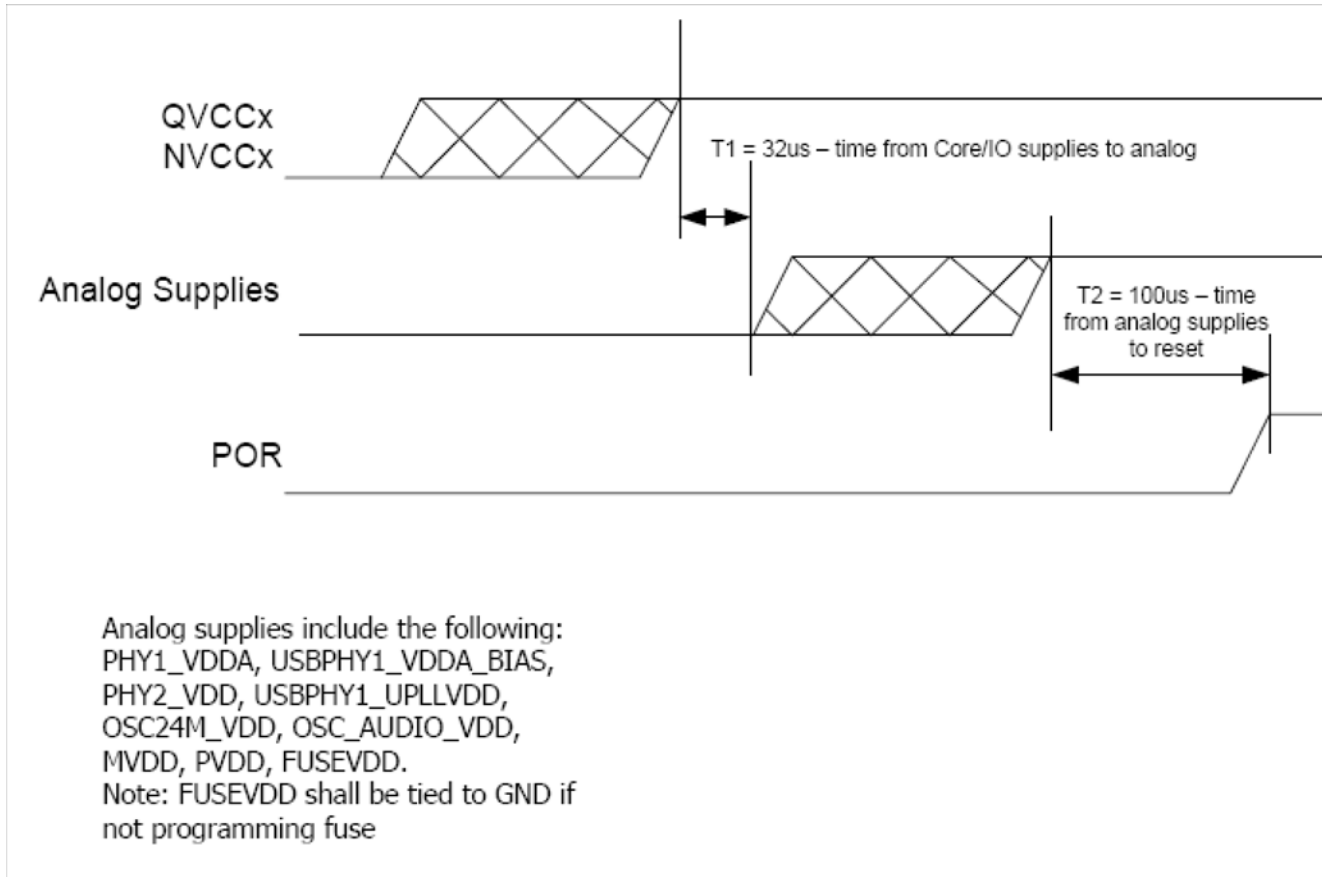

Figure 2. i.MX35 Power-Up Sequence and Timing

4.3.2 Powering Down

The power-up sequence in reverse order is recommended for powering down. However, all power supplies can be shut down at the same time.

4.4 Reset Timing

There are two ways of resetting the i.MX35 using external pins:

- Power On Reset (using the POR_B pin)
- System Reset (using the RESET_IN_B pin)

4.4.1 Power On Reset

POR_B is normally connected to a power management integrated circuit (PMIC). The PMIC asserts POR_B while the power supplies are turned on and negates POR_B after the power up sequence is finished. See [Figure 2](#).

Assuming the i.MX35 chip is already fully powered; it is still possible to reset all of the modules to their default reset by asserting POR_B for at least 4 CKIL cycles and later de-asserting POR_B. This method of resetting the i.MX35 can also be supported by tying the POR_B and RESET_IN_B pins together.

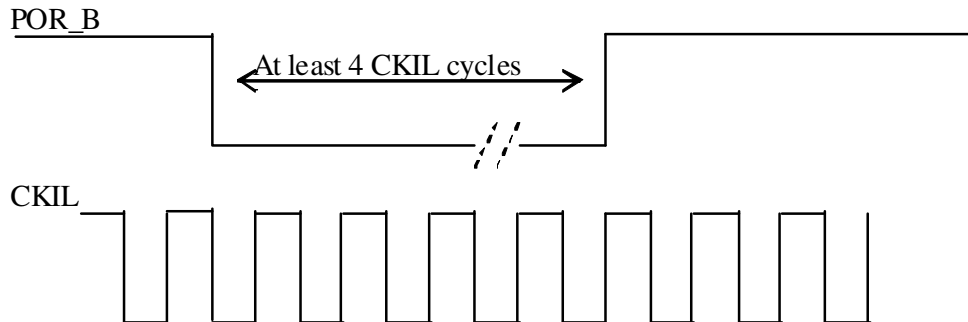

Figure 3. Timing Between POR_B and CKIL for Complete Reset of i.MX35

4.4.2 System Reset

System reset can be achieved by asserting RESET_IN_B for at least 4 CKIL cycles and later negating RESET_IN_B. The following modules are not reset upon system reset: RTC, PLLs, CCM, and IIM. POR_B pin must be deasserted all the time.

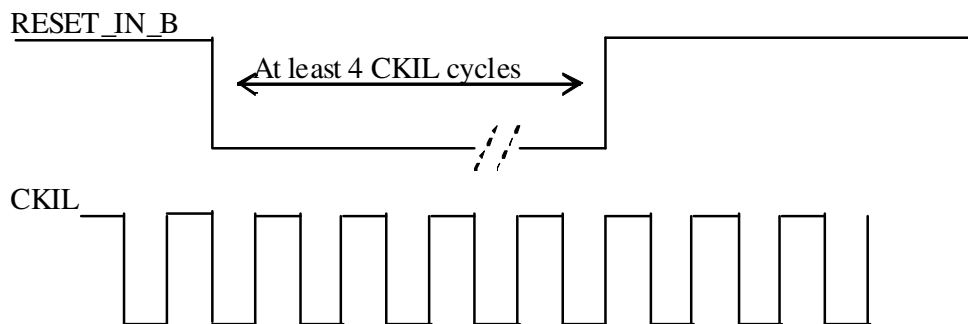

Figure 4. Timing Between RESET_IN_B and CKIL for i.MX35 System Reboot

4.5 Power Characteristics

The table shows values representing maximum current numbers for the i.MX35 under worst case voltage and temperature conditions. These values are derived from the i.MX35 with core clock speeds up to 532 MHz. Common supplies have been bundled according to the i.MX35 power-up sequence requirements. Peak numbers are provided for system designers so that the i.MX35 power supply requirements will be satisfied during startup and transient conditions. Freescale recommends that system current measurements be taken with customer-specific use-cases to reflect normal operating conditions in the end system.

Table 11. Power Consumption

Power Supply	Voltage (V)	Max Current (mA)
QVCC	1.47	400
MVDD, PVDD	1.65	20
NVCC_EMI1, NVCC_EMI2, NVCC_EMI3, NVCC_LCDC, NVCC_NFC	1.9	90
FUSE_VDD ¹	3.6	62
NVCC_MISC, NVCC_CSI, NVCC_SDIO, NVCC_CRM, NVCC_ATA, NVCC_MLB, NVCC_JTAG	3.6	60
OSC24M_VDD, OSC_AUDIO_VDD, PHY1_VDDA, PHY2_VDD, USBPHY1_UPLLVD, USBPHY1_VDDA_BIAS	3.6	25

¹ This rail is connected to ground; it only needs a voltage if eFuses are to be programmed. FUSE_VDD should be supplied by following the power up sequence given in [Section 4.3.1, “Powering Up.”](#)

The method for obtaining max current is as follows:

1. Measure worst case power consumption on individual rails using directed test on i.MX35.
2. Correlate worst case power consumption power measurements with worst case power consumption simulations.
3. Combine common voltage rails based on power supply sequencing requirements
4. Guard band worst case numbers for temperature and process variation. Guard band is based on process data and correlated with actual data measured on i.MX35.
5. The sum of individual rails is greater than real world power consumption, as a real system does not typically maximize power consumption on all peripherals simultaneously.

4.6 Thermal Characteristics

The thermal resistance characteristics for the device are given in [Table 12](#). These values were measured under the following conditions:

- Two-layer substrate
- Substrate solder mask thickness: 0.025 mm
- Substrate metal thicknesses: 0.016 mm
- Substrate core thickness: 0.200 mm
- Core via I.D: 0.168 mm, Core via plating 0.016 mm.
- Full array map design, but nearly all balls under die are power or ground.
- Die Attach: 0.033 mm non-conductive die attach, $k = 0.3 \text{ W/m K}$
- Mold compound: $k = 0.9 \text{ W/m K}$

Table 12. Thermal Resistance Data

Rating	Condition	Symbol	Value	Unit
Junction to ambient ¹ natural convection	Single layer board (1s)	R_{eJA}	53	$^{\circ}\text{C/W}$
Junction to ambient ¹ natural convection	Four layer board (2s2p)	R_{eJA}	30	$^{\circ}\text{C/W}$

Table 12. Thermal Resistance Data (continued)

Rating	Condition	Symbol	Value	Unit
Junction to ambient ¹ (at 200 ft/min)	Single layer board (1s)	R _{eJMA}	44	°C/W
Junction to ambient ¹ (at 200 ft/min)	Four layer board (2s2p)	R _{eJMA}	27	°C/W
Junction to boards ²	—	R _{eJB}	19	°C/W
Junction to case (top) ³	—	R _{eJCtop}	10	°C/W
Junction to package top ⁴	Natural convection	Ψ _{JT}	2	°C/W

¹ Junction-to-ambient thermal resistance determined per JEDEC JESD51-3 and JESD51-6. Thermal test board meets JEDEC specification for this package.

² Junction-to-board thermal resistance determined per JEDEC JESD51-8. Thermal test board meets JEDEC specification for this package.

³ Junction-to-case at the top of the package determined using MIL-STD 883 Method 1012.1. The cold plate temperature is used for the case temperature. Reported value includes the thermal resistance of the interface layer.

⁴ Thermal characterization parameter indicating the temperature difference between the package top and the junction temperature per JEDEC JESD51-2. When Greek letters are not available, this thermal characterization parameter is written as Psi-JT.

4.7 I/O Pin DC Electrical Characteristics

I/O pins are of two types: GPIO and DDR. DDR pins can be configured in three different drive strength modes: mobile DDR, SDRAM, and DDR2. The SDRAM and mobile DDR modes can be further customized at three drive strength levels: normal, high, and max.

Table 13 shows currents for the different DDR pin drive strength modes.

Table 13. DDR Pin Drive Strength Mode Current Levels

Drive Mode	Normal	High	Max.
Mobile DDR (1.8 V)	3.6 mA	7.2 mA	10.8 mA
SDRAM (1.8 V)	—	—	6.5 mA
SDRAM (3.3 V)	4 mA	8 mA	12 mA
DDR2 (1.8 V)	—	—	13.4 mA

Table 14 shows the DC electrical characteristics for GPIO, DDR2, mobile DDR, and SDRAM pins. The term NVCC refers to the power supply voltage that feeds the I/O of the module in question. For example, NVCC for the SD/MMC interface refers to NVCC_SDIO.

Table 14. I/O Pin DC Electrical Characteristics

Pin	DC Electrical Characteristics	Symbol	Test Condition	Min.	Typ.	Max.	Unit
GPIO	High-level output voltage	Voh	Ioh = -1 mA Ioh = specified drive	NVCC - 0.15 0.8 × NVCC	—	—	V
	Low-level output voltage	Vol	Iol = 1 mA Iol = specified drive	—	—	0.15 0.2 × NVCC	V
	High-level output current for slow mode (Voh = 0.8 × NVCC)	Ioh	Standard drive High drive Max. drive	-2.0 -4.0 -8.0	—	—	mA
	High-level output current for fast mode (Voh = 0.8 × NVCC)	Ioh	Standard drive High drive Max. drive	-4.0 -6.0 -8.0	—	—	mA
	Low-level output current for slow mode (Voh = 0.2 × NVCC)	Iol	Standard drive High drive Max. drive	2.0 4.0 8.0	—	—	mA
	Low-level output current for fast mode (Voh = 0.2 × NVCC)	Iol	Standard drive High drive Max. drive	4.0 6.0 8.0	—	—	mA
	High-level DC Input Voltage with 1.8 V, 3.3 V NVCC (for digital cells in input mode)	VIH	—	0.7 × NVCC	—	NVCC	V
	Low-level DC Input Voltage with 1.8 V, 3.3 V NVCC (for digital cells in input mode)	VIL	—	-0.3 V	—	0.3 × NVCC	V
	Input Hysteresis	VHYS	OVDD = 3.3 V OVDD = 1.8 V	—	410 330	—	mV
	Schmitt trigger VT+	VT+	—	0.5 × NVCC	—	—	V
	Schmitt trigger VT-	VT-	—	—	—	0.5 × NVCC	V
	Pull-up resistor (22 kΩ PU)	Rpu	Vi = 0	—	22	—	kΩ
	Pull-up resistor (47 kΩ PU)	Rpu	Vi = 0	—	47	—	kΩ
	Pull-up resistor (100 kΩ PU)	Rpu	Vi = 0	—	100	—	kΩ
	Pull-down resistor (100 kΩ PD)	Rpd	Vi = NVCC	—	100	—	kΩ
	External resistance to pull keeper up when enabled	Rkpu	Ipu > 620 μA @ min Vddio = 3.0 V	—	—	4.8	kΩ
External resistance to pull keeper down when enabled	Rkpd	Ipd > 510 μA @ min Vddio = 3.0 V	—	—	5.9	kΩ	

Table 14. I/O Pin DC Electrical Characteristics (continued)

Pin	DC Electrical Characteristics	Symbol	Test Condition	Min.	Typ.	Max.	Unit
DDR2	High-level output voltage	Voh	—	NVCC – 0.28	—	—	V
	Low-level output voltage	Vol	—	—	—	0.28	V
	Output min. source current	Ioh	—	–13.4	—	—	mA
	Output min. sink current	Iol	—	13.4	—	—	mA
	DC input logic high	VIH(dc)	—	$NVCC \div 2 + 0.125$	—	NVCC + 0.3	V
	DC input logic low	VIL(dc)	—	–0.3 V	—	$NVCC \div 2 - 0.125$	V
	DC input signal voltage (for differential signal)	Vin(dc)	—	–0.3	—	NVCC + 0.3	V
	DC differential input voltage	Vid(dc)	—	0.25	—	NVCC + 0.6	V
	Termination voltage	Vtt	—	$NVCC \div 2 - 0.04$	$NVCC \div 2$	$NVCC \div 2 + 0.04$	V
	Input current (no pull-up/down)	IIN	—	—	—	±1	μA
	Tri-state I/O supply current	Icc – NVCC	—	—	—	±1	μA
Mobile DDR	High-level output voltage	—	I _{OH} = –1mA I _{OH} = specified drive	NVCC – 0.08 0.8 × NVCC	—	—	V
	Low-level output voltage	—	I _{OL} = 1mA I _{OL} = specified drive	—	—	0.08 0.2 × NVCC	V
	High-level output current (Voh = 0.8 × NVCCV)	—	Standard drive High drive Max. drive	–3.6 –7.2 –10.8	—	—	mA
	Low-level output current (Vol = 0.2 × NVCCV)	—	Standard Drive High Drive Max. Drive	3.6 7.2 10.8	—	—	mA
	High-Level DC CMOS input voltage	VIH	—	0.7 × NVCC	—	NVCC + 0.3	V
	Low-Level DC CMOS input voltage	VIL	—	–0.3	—	0.2 × NVCC	V
	Differential receiver VTH+	VTH+	—	—	—	100	mV
	Differential receiver VTH–	VTH–	—	–100	—	—	mV
	Input current (no pull-up/down)	IIN	VI = 0 VI = NVCC	—	—	±1	μA
	Tri-state I/O supply current	Icc – NVCC	VI = NVCC or 0	—	—	±1	μA

Table 14. I/O Pin DC Electrical Characteristics (continued)

Pin	DC Electrical Characteristics	Symbol	Test Condition	Min.	Typ.	Max.	Unit
SDR (1.8 V)	High-level output voltage	Voh	Ioh = 5.7 mA	OVDD – 0.28	—	—	V
	Low-level output voltage	Vol	Ioh = 5.7 mA	—	—	0.4	V
	High-level output current	Ioh	Max. drive	5.7	—	—	mA
	Low-level output current	Iol	Max. drive	7.3	—	—	mA
	High-level DC Input Voltage	VIH	—	1.4	—	1.98	V
	Low-level DC Input Voltage	VIL	—	–0.3	—	0.8	V
	Input current (no pull-up/down)	IIN	VI = 0 VI = NVCC	—	—	150 80	μA
	Tri-state I/O supply current	Icc (NVCC)	VI = OVDD or 0	—	—	1180	μA
	Tri-state core supply current	Icc (NVCC)	VI = VDD or 0	—	—	1220	μA
SDR (3.3 V)	High-level output voltage	Voh	Ioh=specified drive (Ioh = –4, –8, –12, –16 mA)	2.4	—	—	V
	Low-level output voltage	Vol	Ioh=specified drive (Ioh = 4, 8, 12, 16 mA)	—	—	0.4	V
	High-level output current	Ioh	Standard drive High drive Max. drive	–4.0 –8.0 –12.0	—	—	mA
	Low-level output current	Iol	Standard drive High drive Max. drive	4.0 8.0 12.0	—	—	mA
	High-level DC Input Voltage	VIH	—	2.0	—	3.6	V
	Low-level DC Input Voltage	VIL	—	–0.3V	—	0.8	V
	Input current (no pull-up/down)	IIN	VI = 0 VI = NVCC	—	—	±1	μA
	Tri-state I/O supply current	Icc (NVCC)	VI = NVCC or 0	—	—	±1	μA

4.8 I/O Pin AC Electrical Characteristics

Figure 5 shows the load circuit for output pins.

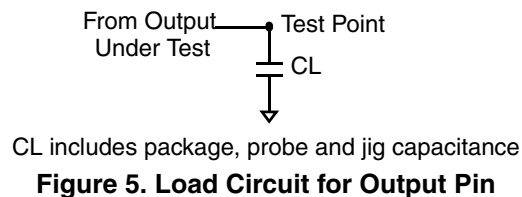

Figure 5. Load Circuit for Output Pin

Figure 6 shows the output pin transition time waveform.

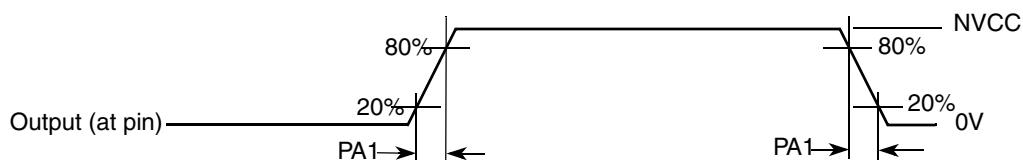

Figure 6. Output Pin Transition Time Waveform

4.8.1 AC Electrical Test Parameter Definitions

AC electrical characteristics in Table 16 through Table 21 are not applicable for the output open drain pull-down driver.

The di/dt parameters are measured with the following methodology:

- The zero voltage source is connected between pin and load capacitance.
- The current (through this source) derivative is calculated during output transitions.

Table 15. AC Requirements of I/O Pins

Parameter	Symbol	Min.	Max.	Units
AC input logic high	$V_{IH}(ac)$	$NVCC \div 2 + 0.25$	$NVCC + 0.3$	V
AC input logic low	$V_{IL}(ac)$	-0.3	$NVCC \div 2 - 0.25$	V

Table 16. AC Electrical Characteristics of GPIO Pins in Slow Slew Rate Mode
[$NVCC = 3.0\text{ V} - 3.6\text{ V}$]

Parameter	Symbol	Test Condition	Min. Rise/Fall	Typ. Rise/Fall	Max. Rise/Fall	Units
Duty cycle	Fduty	—	40	—	60	%
Output pin slew rate (max. drive)	tps	25 pF 50 pF	0.79/1.12 0.49/0.73	1.30/1.77 0.84/1.23	2.02/2.58 1.19/1.58	V/ns
Output pin slew rate (high drive)	tps	25 pF 50 pF	0.48/0.72 0.27/0.42	0.76/1.10 0.41/0.62	1.17/1.56 0.63/0.86	V/ns
Output pin slew rate (standard drive)	tps	25 pF 50 pF	0.25/0.40 0.14/0.21	0.40/0.59 0.21/0.32	0.60/0.83 0.32/0.44	V/ns
Output pin di/dt (max. drive)	tdit	25 pF 50 pF	15 16	36 38	76 80	mA/ns
Output pin di/dt (high drive)	tdit	25 pF 50 pF	8 9	20 21	45 47	mA/ns
Output pin di/dt (standard drive)	tdit	25 pF 50 pF	4 4	10 10	22 23	mA/ns