



Chipsmall Limited consists of a professional team with an average of over 10 year of expertise in the distribution of electronic components. Based in Hongkong, we have already established firm and mutual-benefit business relationships with customers from,Europe,America and south Asia,supplying obsolete and hard-to-find components to meet their specific needs.

With the principle of “Quality Parts,Customers Priority,Honest Operation,and Considerate Service”,our business mainly focus on the distribution of electronic components. Line cards we deal with include Microchip,ALPS,ROHM,Xilinx,Pulse,ON,Everlight and Freescale. Main products comprise IC,Modules,Potentiometer,IC Socket,Relay,Connector.Our parts cover such applications as commercial,industrial, and automotives areas.

We are looking forward to setting up business relationship with you and hope to provide you with the best service and solution. Let us make a better world for our industry!



## Contact us

Tel: +86-755-8981 8866 Fax: +86-755-8427 6832

Email & Skype: info@chipsmall.com Web: www.chipsmall.com

Address: A1208, Overseas Decoration Building, #122 Zhenhua RD., Futian, Shenzhen, China



# Thyristor Module

$$V_{RRM} = 2 \times 1600 \text{ V}$$

$$I_{TAV} = 110 \text{ A}$$

$$V_T = 1.21 \text{ V}$$

Phase leg

Part number

**MCMA110P1600TA**

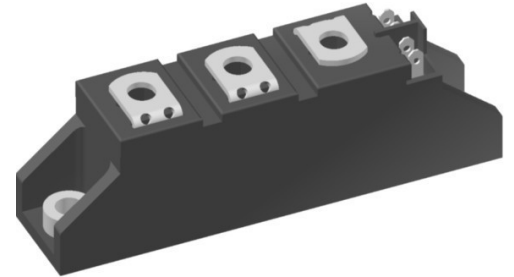

Backside: isolated

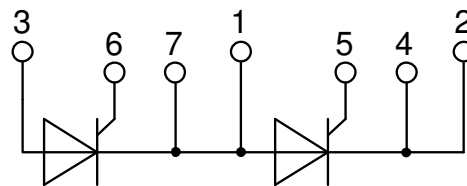

### Features / Advantages:

- Thyristor for line frequency
- Planar passivated chip
- Long-term stability
- Direct Copper Bonded Al<sub>2</sub>O<sub>3</sub>-ceramic

### Applications:

- Line rectifying 50/60 Hz
- Softstart AC motor control
- DC Motor control
- Power converter
- AC power control
- Lighting and temperature control

### Package: TO-240AA

- Isolation Voltage: 4800 V~
- Industry standard outline
- RoHS compliant
- Soldering pins for PCB mounting
- Base plate: DCB ceramic
- Reduced weight
- Advanced power cycling

### Terms .Conditions of usage:

The data contained in this product data sheet is exclusively intended for technically trained staff. The user will have to evaluate the suitability of the product for the intended application and the completeness of the product data with respect to his application. The specifications of our components may not be considered as an assurance of component characteristics. The information in the valid application- and assembly notes must be considered. Should you require product information in excess of the data given in this product data sheet or which concerns the specific application of your product, please contact your local sales office.

Due to technical requirements our product may contain dangerous substances. For information on the types in question please contact your local sales office.

Should you intend to use the product in aviation, in health or life endangering or life support applications, please notify. For any such application we urgently recommend

- to perform joint risk and quality assessments;

- the conclusion of quality agreements;

- to establish joint measures of an ongoing product survey, and that we may make delivery dependent on the realization of any such measures.

Thyristor			Ratings			
Symbol	Definition	Conditions	min.	typ.	max.	Unit
$V_{RSM/DSM}$	max. non-repetitive reverse/forward blocking voltage	$T_{VJ} = 25^{\circ}C$			1700	V
$V_{RRM/DRM}$	max. repetitive reverse/forward blocking voltage	$T_{VJ} = 25^{\circ}C$			1600	V
$I_{RD}$	reverse current, drain current	$V_{R/D} = 1600 V$	$T_{VJ} = 25^{\circ}C$		100	$\mu A$
		$V_{R/D} = 1600 V$	$T_{VJ} = 140^{\circ}C$		10	mA
$V_T$	forward voltage drop	$I_T = 110 A$	$T_{VJ} = 25^{\circ}C$		1.24	V
		$I_T = 220 A$			1.52	V
		$I_T = 110 A$	$T_{VJ} = 125^{\circ}C$		1.21	V
		$I_T = 220 A$			1.57	V
$I_{TAV}$	average forward current	$T_C = 85^{\circ}C$	$T_{VJ} = 140^{\circ}C$		110	A
$I_{T(RMS)}$	RMS forward current	180° sine			170	A
$V_{T0}$	threshold voltage	} for power loss calculation only	$T_{VJ} = 140^{\circ}C$		0.85	V
$r_T$	slope resistance				3.3	m $\Omega$
$R_{thJC}$	thermal resistance junction to case				0.3	K/W
$R_{thCH}$	thermal resistance case to heatsink			0.20		K/W
$P_{tot}$	total power dissipation		$T_C = 25^{\circ}C$		380	W
$I_{TSM}$	max. forward surge current	$t = 10 ms$ ; (50 Hz), sine	$T_{VJ} = 45^{\circ}C$		1.90	kA
		$t = 8,3 ms$ ; (60 Hz), sine	$V_R = 0 V$		2.05	kA
		$t = 10 ms$ ; (50 Hz), sine	$T_{VJ} = 140^{\circ}C$		1.62	kA
		$t = 8,3 ms$ ; (60 Hz), sine	$V_R = 0 V$		1.75	kA
$I^2t$	value for fusing	$t = 10 ms$ ; (50 Hz), sine	$T_{VJ} = 45^{\circ}C$		18.1	kA <sup>2</sup> s
		$t = 8,3 ms$ ; (60 Hz), sine	$V_R = 0 V$		17.5	kA <sup>2</sup> s
		$t = 10 ms$ ; (50 Hz), sine	$T_{VJ} = 140^{\circ}C$		13.0	kA <sup>2</sup> s
		$t = 8,3 ms$ ; (60 Hz), sine	$V_R = 0 V$		12.7	kA <sup>2</sup> s
$C_J$	junction capacitance	$V_R = 400 V$ $f = 1 MHz$	$T_{VJ} = 25^{\circ}C$		95	pF
$P_{GM}$	max. gate power dissipation	$t_p = 30 \mu s$	$T_C = 140^{\circ}C$		10	W
		$t_p = 300 \mu s$			5	W
$P_{GAV}$	average gate power dissipation				0.5	W
$(di/dt)_{cr}$	critical rate of rise of current	$T_{VJ} = 140^{\circ}C$ ; $f = 50 Hz$ repetitive, $I_T = 330 A$			150	A/ $\mu s$
		$t_p = 200 \mu s$ ; $di_G/dt = 0.45 A/\mu s$ ; $I_G = 0.45 A$ ; $V = \frac{2}{3} V_{DRM}$ non-repet., $I_T = 110 A$			500	A/ $\mu s$
$(dv/dt)_{cr}$	critical rate of rise of voltage	$V = \frac{2}{3} V_{DRM}$ $R_{GK} = \infty$ ; method 1 (linear voltage rise)	$T_{VJ} = 140^{\circ}C$		1000	V/ $\mu s$
$V_{GT}$	gate trigger voltage	$V_D = 6 V$	$T_{VJ} = 25^{\circ}C$		1.5	V
			$T_{VJ} = -40^{\circ}C$		1.6	V
$I_{GT}$	gate trigger current	$V_D = 6 V$	$T_{VJ} = 25^{\circ}C$		150	mA
			$T_{VJ} = -40^{\circ}C$		200	mA
$V_{GD}$	gate non-trigger voltage	$V_D = \frac{2}{3} V_{DRM}$	$T_{VJ} = 140^{\circ}C$		0.2	V
$I_{GD}$	gate non-trigger current				10	mA
$I_L$	latching current	$t_p = 10 \mu s$	$T_{VJ} = 25^{\circ}C$		200	mA
		$I_G = 0.45 A$ ; $di_G/dt = 0.45 A/\mu s$				
$I_H$	holding current	$V_D = 6 V$ $R_{GK} = \infty$	$T_{VJ} = 25^{\circ}C$		200	mA
$t_{gd}$	gate controlled delay time	$V_D = \frac{1}{2} V_{DRM}$	$T_{VJ} = 25^{\circ}C$		2	$\mu s$
		$I_G = 0.45 A$ ; $di_G/dt = 0.45 A/\mu s$				
$t_q$	turn-off time	$V_R = 100 V$ ; $I_T = 110 A$ ; $V = \frac{2}{3} V_{DRM}$ $di/dt = 10 A/\mu s$ $dv/dt = 20 V/\mu s$ $t_p = 200 \mu s$	$T_{VJ} = 125^{\circ}C$		185	$\mu s$

Package TO-240AA				Ratings			
Symbol	Definition	Conditions	min.	typ.	max.	Unit	
$I_{RMS}$	RMS current	per terminal			200	A	
$T_{VJ}$	virtual junction temperature		-40		140	°C	
$T_{op}$	operation temperature		-40		125	°C	
$T_{stg}$	storage temperature		-40		125	°C	
<b>Weight</b>					81	g	
$M_D$	mounting torque		2.5		4	Nm	
$M_T$	terminal torque		2.5		4	Nm	
$d_{Spp/App}$	creepage distance on surface   striking distance through air	terminal to terminal	13.0	9.7		mm	
$d_{Spb/Apb}$		terminal to backside	16.0	16.0		mm	
$V_{ISOL}$	isolation voltage	t = 1 second		4800		V	
		t = 1 minute	50/60 Hz, RMS; $I_{ISOL} \leq 1$ mA	4000		V	

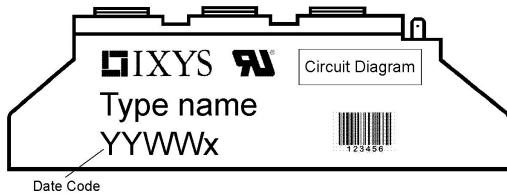
**Part description**

M = Module  
 C = Thyristor (SCR)  
 M = Thyristor  
 A = (up to 1800V)  
 110 = Current Rating [A]  
 P = Phase leg  
 1600 = Reverse Voltage [V]  
 TA = TO-240AA-1B

Ordering	Ordering Number	Marking on Product	Delivery Mode	Quantity	Code No.
Standard	MCMA110P1600TA	MCMA110P1600TA	Box	36	513383

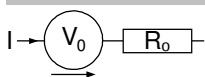
**Equivalent Circuits for Simulation**
*\* on die level*
 $T_{VJ} = 140^\circ\text{C}$ 

**Thyristor**

$V_{0\ max}$	threshold voltage	0.85	V
$R_{0\ max}$	slope resistance *	2.1	mΩ

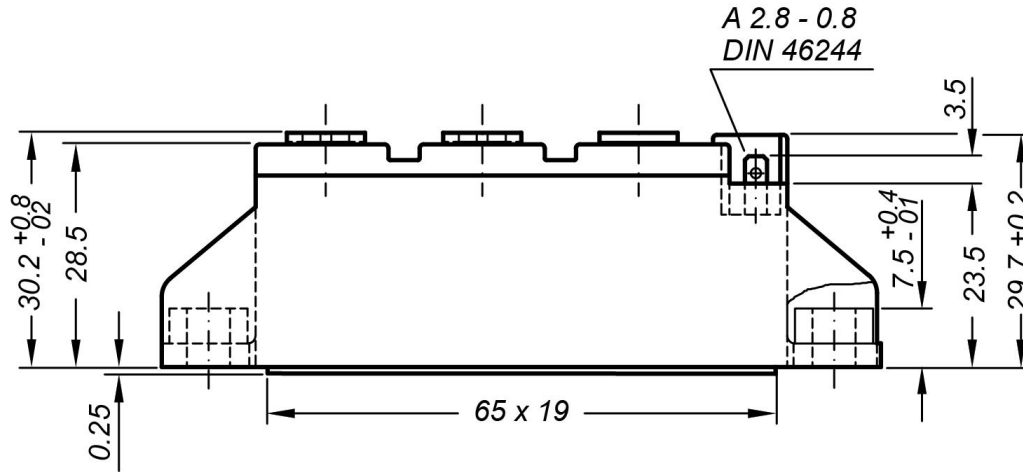
**Outlines TO-240AA**

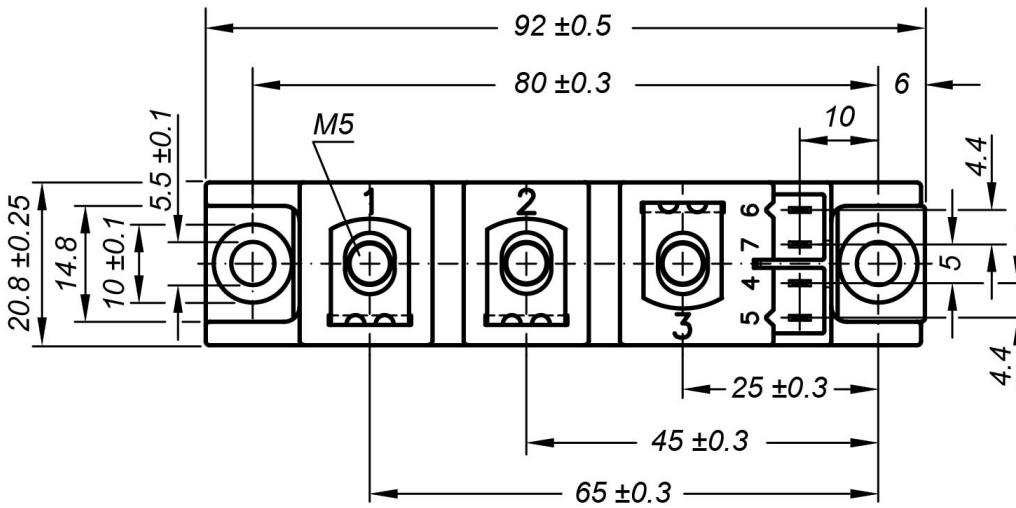

General tolerance: DIN ISO 2768 class „c“



Optional accessories: Keyed gate/cathode twin plugs  
 Wire length: 350 mm, gate = white, cathode = red  
 UL 758, style 3751  
 Type **ZY 200L** (L = Left for pin pair 4/5)  
 Type **ZY 200R** (R = Right for pin pair 6/7)

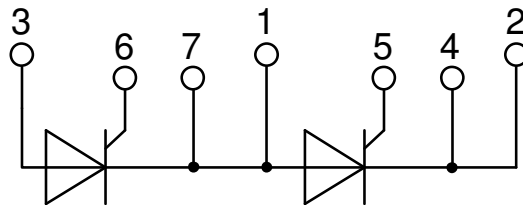

**Thyristor**

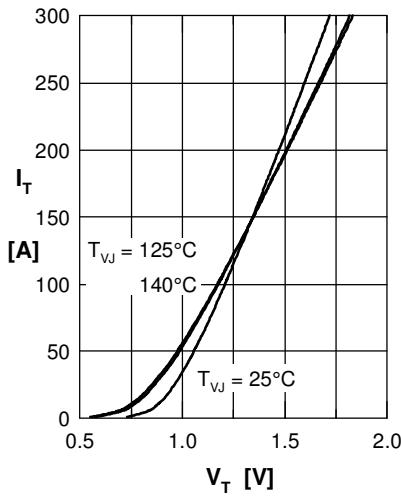

Fig. 1 Forward characteristics

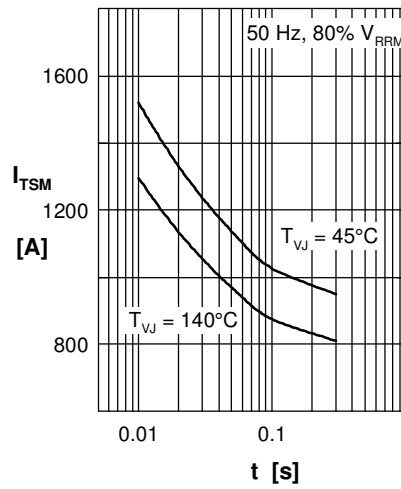

Fig. 2 Surge overload current  
 $I_{TSM}$ : crest value,  $t$ : duration

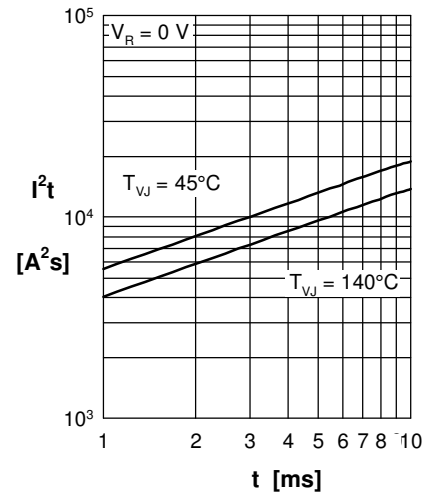

Fig. 3  $I^2t$  versus time (1-10 s)

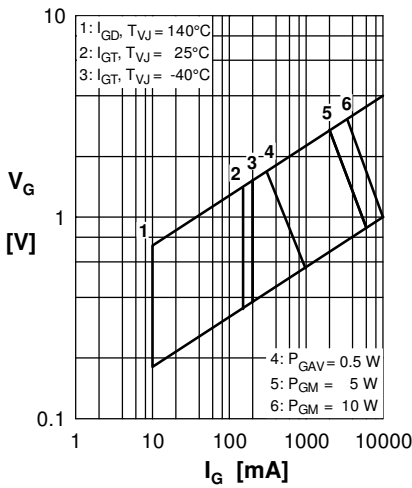

Fig. 4 Gate voltage & gate current

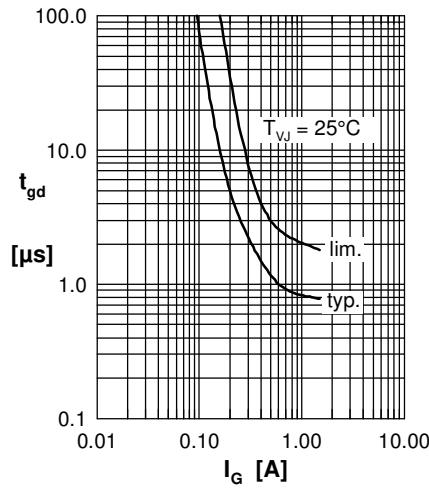

Fig. 5 Gate controlled delay time  $t_{gd}$

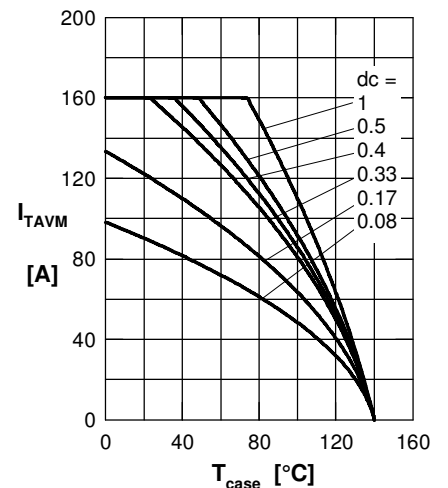

Fig. 6 Max. forward current at case temperature

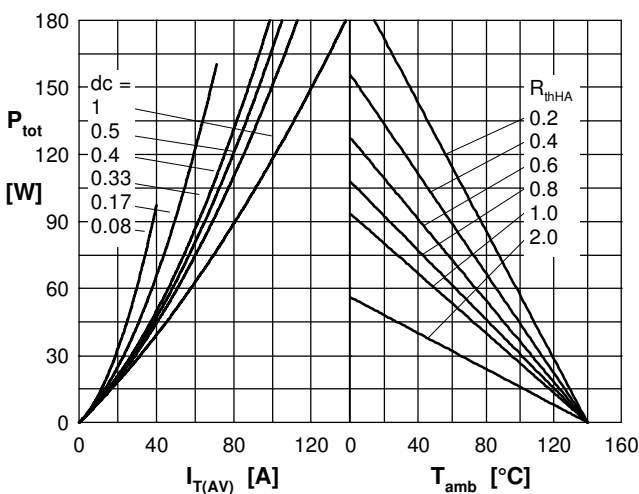

Fig. 7a Power dissipation versus direct output current  
Fig. 7b and ambient temperature

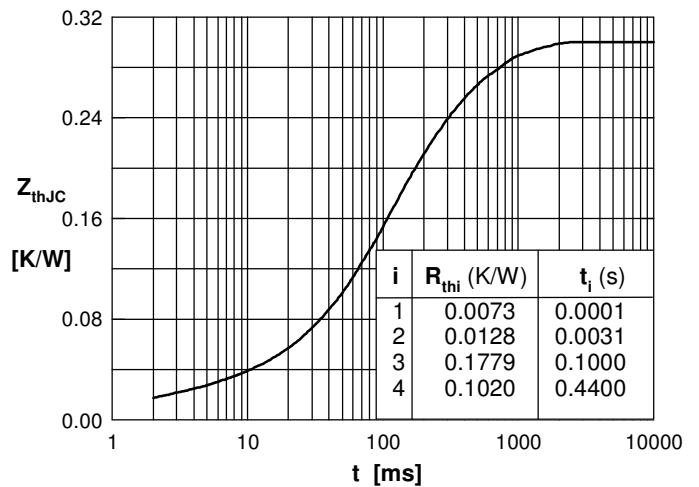

Fig. 8 Transient thermal impedance junction to case