



Chipsmall Limited consists of a professional team with an average of over 10 year of expertise in the distribution of electronic components. Based in Hongkong, we have already established firm and mutual-benefit business relationships with customers from,Europe,America and south Asia,supplying obsolete and hard-to-find components to meet their specific needs.

With the principle of “Quality Parts,Customers Priority,Honest Operation,and Considerate Service”,our business mainly focus on the distribution of electronic components. Line cards we deal with include Microchip,ALPS,ROHM,Xilinx,Pulse,ON,Everlight and Freescale. Main products comprise IC,Modules,Potentiometer,IC Socket,Relay,Connector.Our parts cover such applications as commercial,industrial, and automotives areas.

We are looking forward to setting up business relationship with you and hope to provide you with the best service and solution. Let us make a better world for our industry!



Contact us

Tel: +86-755-8981 8866 Fax: +86-755-8427 6832

Email & Skype: info@chipsmall.com Web: www.chipsmall.com

Address: A1208, Overseas Decoration Building, #122 Zhenhua RD., Futian, Shenzhen, China





MCP1650 SEPIC Demo Board User's Guide

Note the following details of the code protection feature on Microchip devices:

- Microchip products meet the specification contained in their particular Microchip Data Sheet.
- Microchip believes that its family of products is one of the most secure families of its kind on the market today, when used in the intended manner and under normal conditions.
- There are dishonest and possibly illegal methods used to breach the code protection feature. All of these methods, to our knowledge, require using the Microchip products in a manner outside the operating specifications contained in Microchip's Data Sheets. Most likely, the person doing so is engaged in theft of intellectual property.
- Microchip is willing to work with the customer who is concerned about the integrity of their code.
- Neither Microchip nor any other semiconductor manufacturer can guarantee the security of their code. Code protection does not mean that we are guaranteeing the product as "unbreakable."

Code protection is constantly evolving. We at Microchip are committed to continuously improving the code protection features of our products. Attempts to break Microchip's code protection feature may be a violation of the Digital Millennium Copyright Act. If such acts allow unauthorized access to your software or other copyrighted work, you may have a right to sue for relief under that Act.

Information contained in this publication regarding device applications and the like is provided only for your convenience and may be superseded by updates. It is your responsibility to ensure that your application meets with your specifications. MICROCHIP MAKES NO REPRESENTATIONS OR WARRANTIES OF ANY KIND WHETHER EXPRESS OR IMPLIED, WRITTEN OR ORAL, STATUTORY OR OTHERWISE, RELATED TO THE INFORMATION, INCLUDING BUT NOT LIMITED TO ITS CONDITION, QUALITY, PERFORMANCE, MERCHANTABILITY OR FITNESS FOR PURPOSE. Microchip disclaims all liability arising from this information and its use. Use of Microchip's products as critical components in life support systems is not authorized except with express written approval by Microchip. No licenses are conveyed, implicitly or otherwise, under any Microchip intellectual property rights.

Trademarks

The Microchip name and logo, the Microchip logo, Accuron, dsPIC, KEELOQ, microID, MPLAB, PIC, PICmicro, PICSTART, PRO MATE, PowerSmart, rfPIC, and SmartShunt are registered trademarks of Microchip Technology Incorporated in the U.S.A. and other countries.

AmpLab, FilterLab, Migratable Memory, MXDEV, MXLAB, PICMASTER, SEEVAL, SmartSensor and The Embedded Control Solutions Company are registered trademarks of Microchip Technology Incorporated in the U.S.A.

Analog-for-the-Digital Age, Application Maestro, dsPICDEM, dsPICDEM.net, dsPICworks, ECAN, ECONOMONITOR, FanSense, FlexROM, fuzzyLAB, In-Circuit Serial Programming, ICSP, ICEPIC, Linear Active Thermistor, MPASM, MPLIB, MPLINK, MPSIM, PICKit, PICDEM, PICDEM.net, PICLAB, PICtail, PowerCal, PowerInfo, PowerMate, PowerTool, rLAB, rfPICDEM, Select Mode, Smart Serial, SmartTel, Total Endurance and WiperLock are trademarks of Microchip Technology Incorporated in the U.S.A. and other countries.

SQTP is a service mark of Microchip Technology Incorporated in the U.S.A.

All other trademarks mentioned herein are property of their respective companies.

© 2005, Microchip Technology Incorporated, Printed in the U.S.A., All Rights Reserved.

 Printed on recycled paper.

**QUALITY MANAGEMENT SYSTEM
CERTIFIED BY DNV
== ISO/TS 16949:2002 ==**

Microchip received ISO/TS-16949:2002 quality system certification for its worldwide headquarters, design and wafer fabrication facilities in Chandler and Tempe, Arizona and Mountain View, California in October 2003. The Company's quality system processes and procedures are for its PICmicro® 8-bit MCUs, KEELOQ® code hopping devices, Serial EEPROMs, microperipherals, nonvolatile memory and analog products. In addition, Microchip's quality system for the design and manufacture of development systems is ISO 9001:2000 certified.



MCP1650 SEPIC DEMO BOARD USER'S GUIDE

Table of Contents

Preface	1
Chapter 1. Product Overview	5
1.1 Introduction	5
1.2 What is the MCP1650 SEPIC Demo Board?	5
1.3 What the MCP1650 SEPIC Demo Board Kit Includes	5
Chapter 2. Installation and Operation	7
2.1 Introduction	7
2.2 Features	7
2.3 Getting Started	8
Appendix A. Schematic and Layout	11
A.1 Introduction	11
A.2 Board Schematic	12
A.3 Board – Top Overlay	13
A.4 Board – Top Layer	14
A.5 Board – Bottom Layer	15
Appendix B. Bill Of Materials (BOM)	17
Worldwide Sales and Service	18

MCP1650 SEPIC Demo Board User's Guide

NOTES:

Preface

NOTICE TO CUSTOMERS

All documentation becomes dated, and this manual is no exception. Microchip tools and documentation are constantly evolving to meet customer needs, so some actual dialogs and/or tool descriptions may differ from those in this document. Please refer to our web site (www.microchip.com) to obtain the latest documentation available.

Documents are identified with a “DS” number. This number is located on the bottom of each page, in front of the page number. The numbering convention for the DS number is “DSXXXXA”, where “XXXX” is the document number and “A” is the revision level of the document.

INTRODUCTION

This chapter contains general information that will be useful to know before using the MCP1650 SEPIC Demo Board. Items discussed in this chapter include:

- Document Layout
- Conventions Used in this Guide
- Recommended Reading
- The Microchip Web Site
- Customer Support
- Document Revision History

DOCUMENT LAYOUT

This document describes how to use the MCP1650 SEPIC Demo Board. The manual layout is as follows:

- **Chapter 1. “Product Overview”** – Important information about the MCP1650 SEPIC Demo Board.
- **Chapter 2. “Installation and Operation”** – Includes a description of the evaluation board, as well as instructions on how to get started.
- **Appendix A. “Schematic and Layout”** – Shows the schematic and layout diagrams for the MCP1650 SEPIC Demo Board.
- **Appendix B. “Bill Of Materials (BOM)”** – Lists the parts used to build the MCP1650 SEPIC Demo Board.

MCP1650 SEPIC Demo Board User's Guide

CONVENTIONS USED IN THIS GUIDE

This manual uses the following documentation conventions:

DOCUMENTATION CONVENTIONS

Description	Represents	Examples
Arial font:		
Italic characters	Referenced books	<i>MPLAB[®] IDE User's Guide</i>
	Emphasized text	...is the <i>only</i> compiler...
Initial caps	A window	the Output window
	A dialog	the Settings dialog
	A menu selection	select Enable Programmer
Quotes	A field name in a window or dialog	"Save project before build"
Underlined, italic text with right angle bracket	A menu path	<u><i>File>Save</i></u>
Bold characters	A dialog button	Click OK
	A tab	Click the Power tab
Text in angle brackets < >	A key on the keyboard	Press <Enter>, <F1>
Courier New font:		
Plain Courier New	Sample source code	#define START
	Filenames	autoexec.bat
	File paths	c:\mcc18\h
	Keywords	_asm, _endasm, static
	Command-line options	-Opa+, -Opa-
	Bit values	0, 1
	Constants	0xFF, 'A'
Italic Courier New	A variable argument	<i>file.o</i> , where <i>file</i> can be any valid filename
Square brackets []	Optional arguments	mcc18 [options] <i>file</i> [options]
Curly brackets and pipe character: { }	Choice of mutually exclusive arguments; an OR selection	errorlevel {0 1}
Ellipses...	Replaces repeated text	var_name [, var_name...]
	Represents code supplied by user	void main (void) { ... }

RECOMMENDED READING

This user's guide describes how to use the MCP1650 SEPIC Demo Board. The following Microchip documents are available and recommended as supplemental reference resources.

MCP1650/51/52/53 Data Sheet, "750 kHz Boost Controller" (DS21876)

This data sheet provides detailed information regarding the MCP1650/51/52/53 family of boost controllers.

THE MICROCHIP WEB SITE

Microchip provides online support via our web site at www.microchip.com. This web site is used as a means to make files and information easily available to customers. Accessible by using your favorite Internet browser, the web site contains the following information:

- **Product Support** – Data sheets and errata, application notes and sample programs, design resources, user's guides and hardware support documents, latest software releases and archived software
- **General Technical Support** – Frequently Asked Questions (FAQs), technical support requests, online discussion groups, Microchip consultant program member listing
- **Business of Microchip** – Product selector and ordering guides, latest Microchip press releases, listing of seminars and events, listings of Microchip sales offices, distributors and factory representatives

CUSTOMER SUPPORT

Users of Microchip products can receive assistance through several channels:

- Distributor or Representative
- Local Sales Office
- Field Application Engineer (FAE)
- Technical Support
- Development Systems Information Line

Customers should contact their distributor, representative or field application engineer (FAE) for support. Local sales offices are also available to help customers. A listing of sales offices and locations is included in the back of this document.

Technical support is available through the web site at: <http://support.microchip.com>

DOCUMENT REVISION HISTORY

Revision A (September 2005)

- Initial Release of this Document.

MCP1650 SEPIC Demo Board User's Guide

NOTES:

Chapter 1. Product Overview

1.1 INTRODUCTION

The MCP1650 SEPIC Demo Board is used to evaluate Microchip's MCP1650 boost controller in a low-power application that requires a regulated output voltage from an input voltage that can be greater than, less than or equal to the output voltage. As provided, the MCP1650 SEPIC Demo Board generates a 5.0V output from a 3V to 7V source.

This chapter covers the following topics:

- What is the MCP1650 SEPIC Demo Board?
- What the MCP1650 SEPIC Demo Board Kit Includes.

1.2 WHAT IS THE MCP1650 SEPIC DEMO BOARD?

The MCP1650 SEPIC Demo Board is a complete, step-up or step-down, Switch mode, DC-DC power converter. The MCP1650 SEPIC Demo Board generates a regulated 5.0V output at load currents up to 160 mA. The SEPIC topology has the ability to step-up or step-down the input voltage. The input voltage range for the MCP1650 SEPIC Demo Board is from 3.0V to 7.0V.

Test points are provided for input power, output load and shutdown control.

1.3 WHAT THE MCP1650 SEPIC DEMO BOARD KIT INCLUDES

This MCP1650 SEPIC Demo Board kit includes:

- The MCP1650 SEPIC Demo Board (102-00079)
- The MCP1650 SEPIC Demo Board User's Guide (DS51581)
- MCP1650/51/52/53 Data Sheet, "750 kHz Boost Controller" (DS21876)

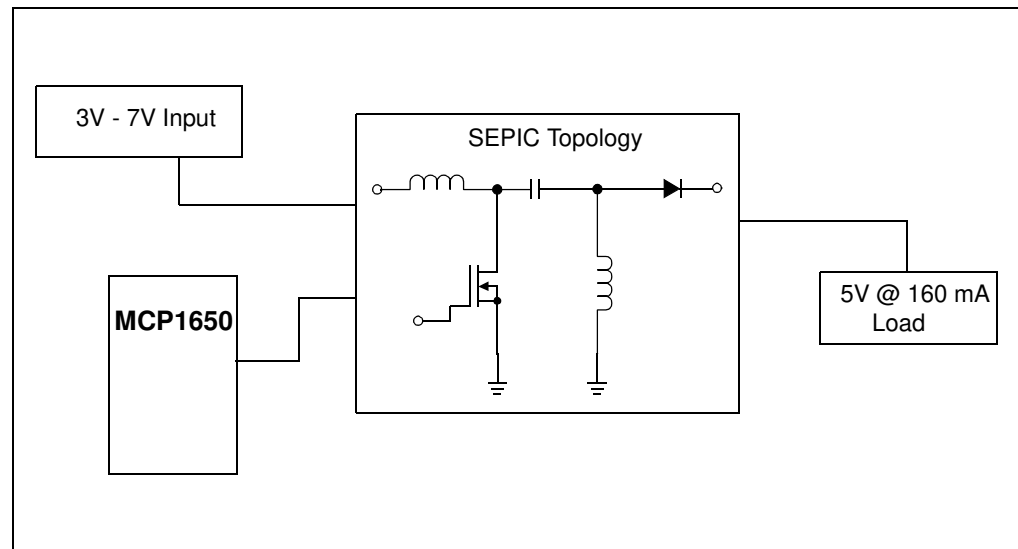

FIGURE 1-1: MCP1650 SEPIC Demo Board Block Diagram.

MCP1650 SEPIC Demo Board User's Guide

NOTES:

Chapter 2. Installation and Operation

2.1 INTRODUCTION

The MCP1650 SEPIC Demo Board demonstrates Microchip's MCP1650 750 kHz Boost Controller in an application that requires a regulated output voltage from a source that is greater than, less than or equal to the regulated output voltage. The MCP1650 is a gated oscillator boost controller developed for high-power, portable applications. By driving an external MOSFET, the MCP1650 controller can deliver 5 watts of power to the load. The high switching frequency minimizes the size of the external inductor and capacitor, saving both board space and cost.

The Single-Ended Primary Inductance Converter (SEPIC) topology utilized on this board has the ability to produce a regulated output from a wide-ranging source. Some advantages of the SEPIC topology versus other topologies are the low-ripple input current, the ability to step-up or step-down the input voltage without inverting the output voltage, no required transformer and the output is capacitively isolated from the input to protect against switch failure.

2.2 FEATURES

The MCP1650 SEPIC Demo Board has the following features:

- Wide input voltage range: 3.0V to 7.0V
- Regulated 5.0V output voltage
- Maximum output current: 160 mA
- Complete low-profile, space-saving power supply
- Test point to apply external Enable signal

MCP1650 SEPIC Demo Board User's Guide

2.3 GETTING STARTED

The MCP1650 SEPIC Demo Board is fully assembled and tested for generating a regulated 5.0V output voltage. The MCP1650 SEPIC Demo Board requires the use of an external input voltage source (3.0V–7.0V).

2.3.1 Power Input and Output Connections

2.3.1.1 POWERING THE MCP1650 SEPIC DEMO BOARD

Apply the input voltage to the V_{IN} (TP1) and GND (TP2) test points. The input voltage should be limited to the 0V to +7.0V range. For normal operation, the input voltage must be between +3.0V and +7.0V.

2.3.1.2 APPLY THE LOAD TO THE REGULATED OUTPUT VOLTAGE TEST POINTS

1. To apply a load to the MCP1650 SEPIC Demo Board, the positive side (+) of the load should be connected to the V_{OUT} test point (TP4). The negative side (–) of the load should be connected to the GND test point (TP5).
2. The maximum load current for the MCP1650 SEPIC Demo Board is 160 mA. Applying a load greater than the stated maximum will cause the output voltage to pull out of regulation.

2.3.1.3 ENABLING/DISABLING THE MCP1650 SEPIC DEMO BOARD

The $\overline{\text{SHDN}}$ pin of the MCP1650 is pulled-up to V_{IN} so that the device is always enabled. The SHDN test point (TP3) can be used to apply an external Enable signal to the device. Pulling TP3 to ground will disable the part.

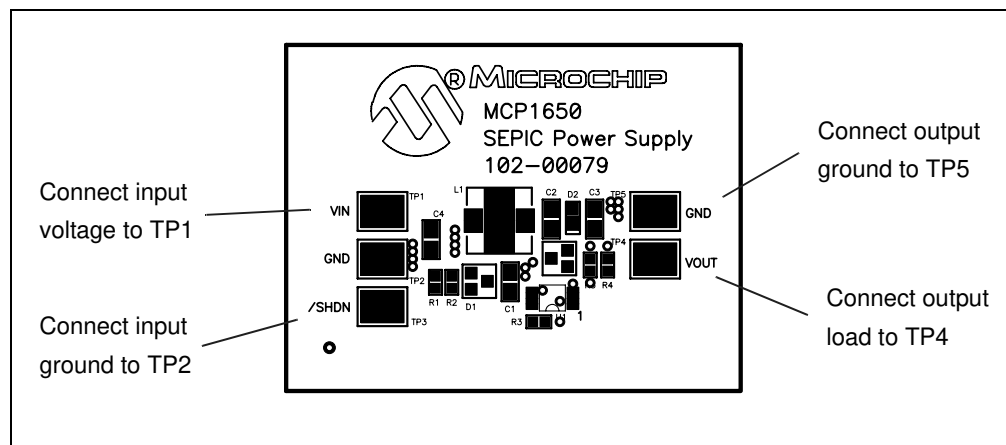

FIGURE 2-1: MCP1650 SEPIC Demo Board Assembly Drawing.

2.3.2 Evaluating the Application

The MCP1650 SEPIC Demo Board can be used to provide a low-cost, minimal size, low-power bias circuit. A well-regulated 5V at 160 mA output is produced from a 3.0V to 7.0V input source. This voltage range allows the source to be a single Li-Ion battery or three to four NiMH batteries.

The SEPIC topology is employed to convert this wide-ranging input source to a well-regulated 5 volts. The SEPIC has the ability to automatically buck or boost the input source. By coupling the two inductors onto one magnetic core, a small footprint, low parts-count, low-power step-up or step-down converter is developed.

To truly evaluate the effectiveness of the MCP1650 SEPIC Demo Board, the input voltage must be varied over the entire operating range, while the load is varied from 0A to 160 mA. Test points are provided for connecting the variable input voltage source (TP1 and TP2) and a variable load (TP4 and TP5). An additional test point (TP3) is connected to the shutdown pin (SHDN) of the MCP1650. On the board, the SHDN pin is pulled-up to V_{IN} . However, by connecting TP3 to GND, the converter can be disabled.

MCP1650 SEPIC Demo Board User's Guide

NOTES:



MCP1650 SEPIC DEMO BOARD USER'S GUIDE

Appendix A. Schematic and Layout

A.1 INTRODUCTION

This appendix contains the following schematic and layout diagrams for the MCP1650 SEPIC Demo Board:

- Board Schematic
- Board – Top Overlay
- Board – Top Layer
- Board – Bottom Layer

MCP1650 SEPIC Demo Board User's Guide

A.2 BOARD SCHEMATIC

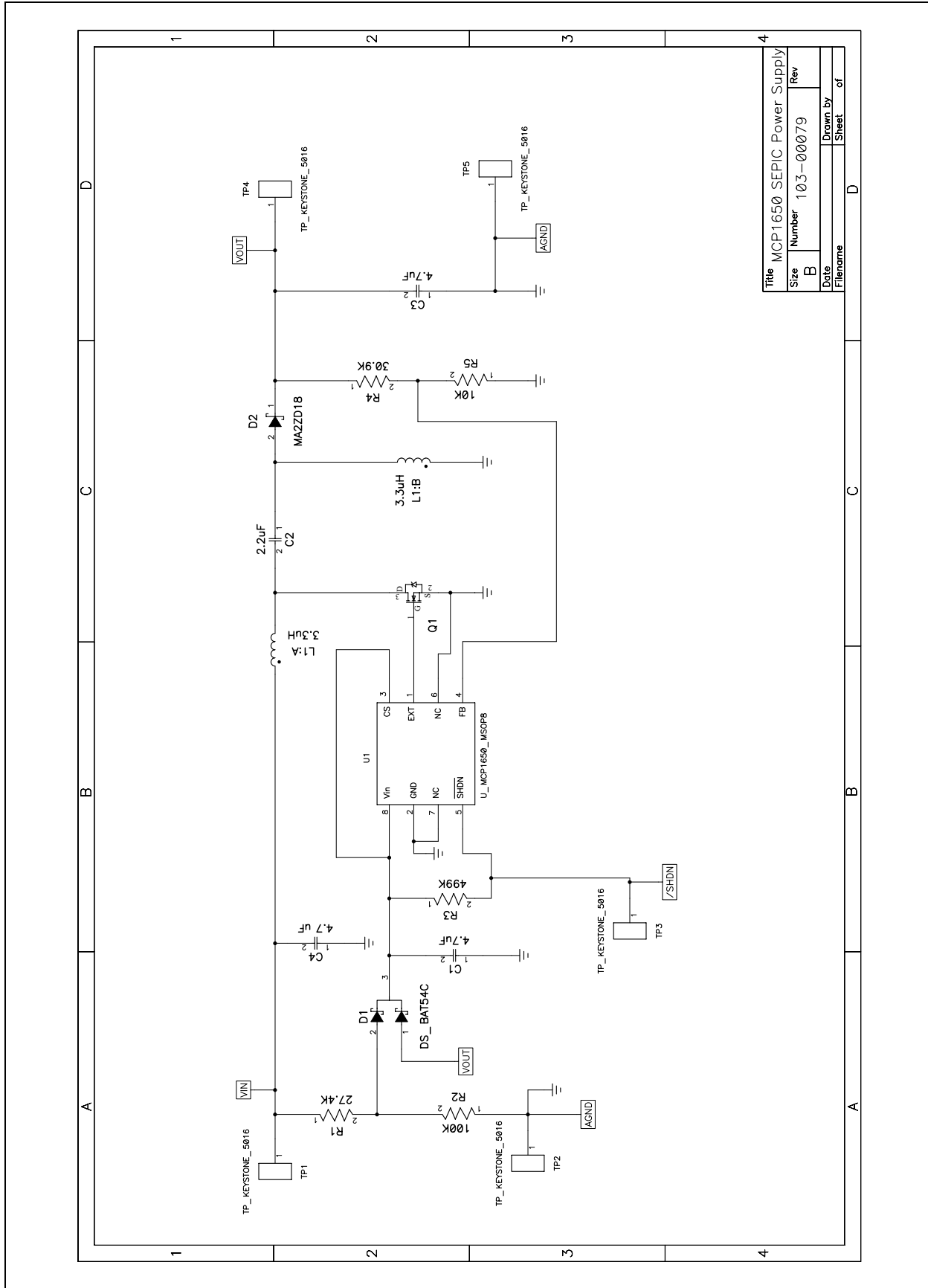

A.3 BOARD – TOP OVERLAY

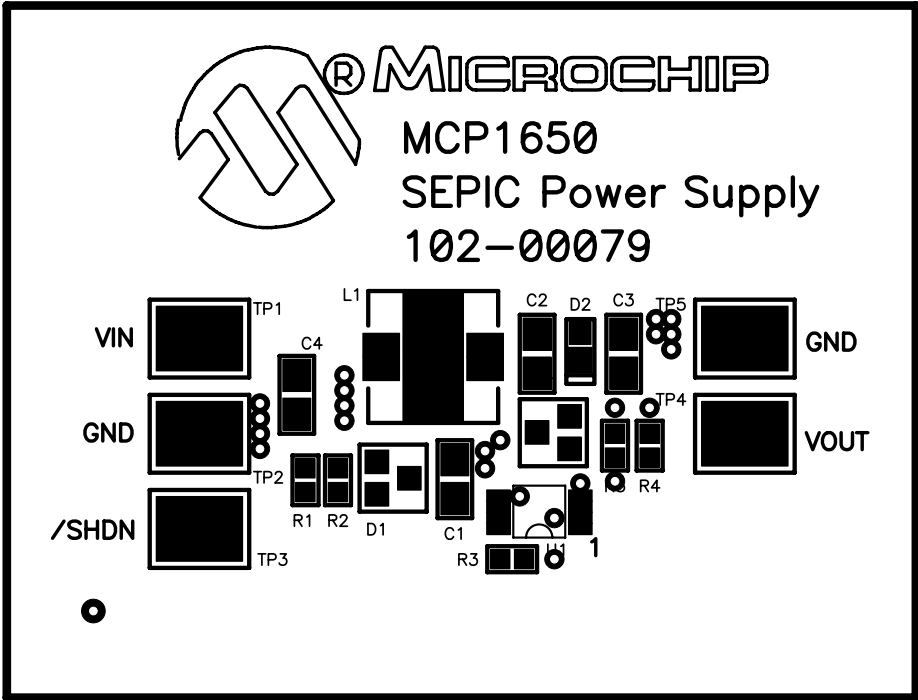

A.4 BOARD – TOP LAYER

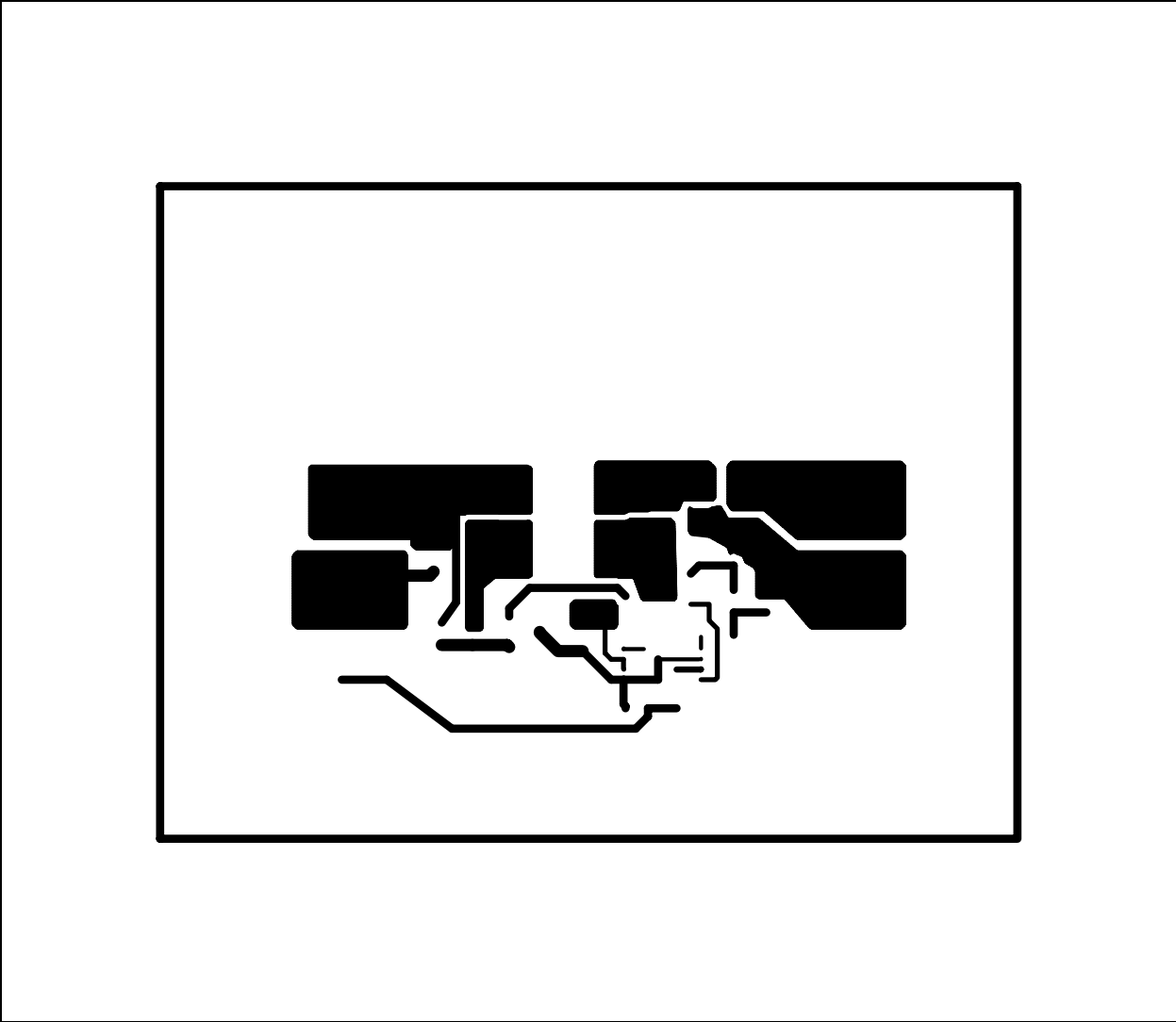

A.5 BOARD – BOTTOM LAYER

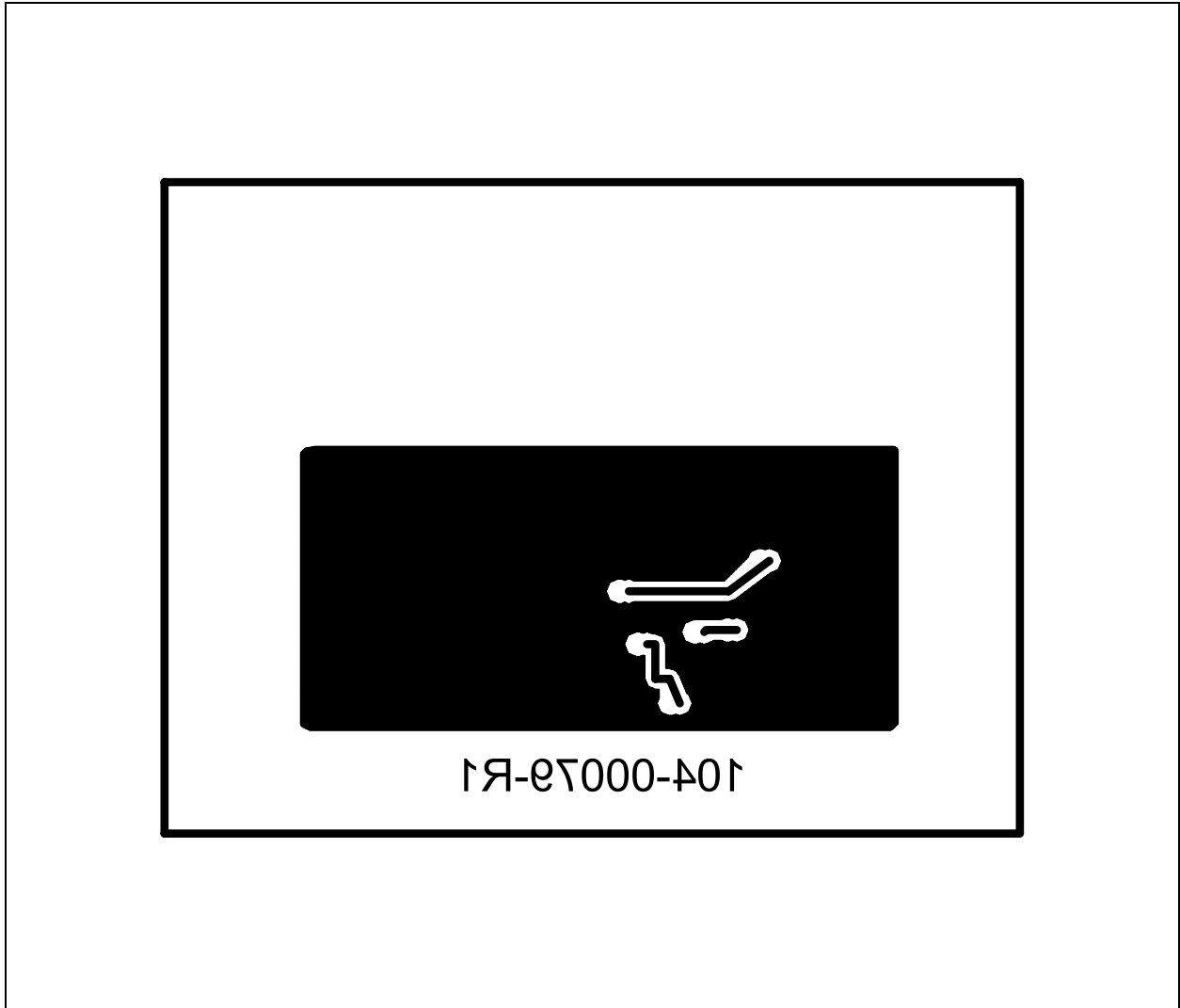

MCP1650 SEPIC Demo Board User's Guide

NOTES:



MCP1650 SEPIC DEMO BOARD USER'S GUIDE

Appendix B. Bill Of Materials (BOM)

TABLE B-1: BILL OF MATERIALS (BOM)

Qty.	Reference	Description	Mfgr.	Part Number
3	C1, C3, C4	4.7 μ F, X5R Ceramic, 16V, 0805	Panasonic®	ECJ-2FB1C475K
1	C2	2.2 μ F, X5R Ceramic, 16V, 0805	Panasonic	ECJ-2FB1C225K
1	L1	3.3 μ H, Dual Inductor	Coiltronics®	DRQ73-3R3
1	D1	Schottky Diode, 30V, Dual	Philips Electronics	BAT54C
1	D2	Schottky Diode, 20V	Panasonic	MA2ZD1800L
1	Q1	N-Channel 20V 4.2A MOSFET	International Rectifier	IRLML2502
1	R5	10 K Ω , 1/10W, 1%, 0603	Rohm	MCR03EZPJ103
1	R1	27.4 K Ω , 1/10W, 1%, 0603	Rohm	MCR03EZPFX2742
1	R4	30.9 K Ω , 1/10W, 1%, 0603	Rohm	MCR03EZPFX3092
1	R2	100 K Ω , 1/10W, 1%, 0603	Rohm	MCR03EZPFX1003
1	R3	499 K Ω , 1/10W, 1%, 0603	Rohm	MCR03EZPFX4993
5	TP1, TP2, TP3, TP4, TP5	Test Point	Keystone Electronics®	5016
1	U1	750 kHz, Boost Controller, MSOP	Microchip Technology Inc.	MCP1650R-E/MS



WORLDWIDE SALES AND SERVICE

AMERICAS

Corporate Office
2355 West Chandler Blvd.
Chandler, AZ 85224-6199
Tel: 480-792-7200
Fax: 480-792-7277
Technical Support:
<http://support.microchip.com>
Web Address:
www.microchip.com

Atlanta
Alpharetta, GA
Tel: 770-640-0034
Fax: 770-640-0307

Boston
Westborough, MA
Tel: 774-760-0087
Fax: 774-760-0088

Chicago
Itasca, IL
Tel: 630-285-0071
Fax: 630-285-0075

Dallas
Addison, TX
Tel: 972-818-7423
Fax: 972-818-2924

Detroit
Farmington Hills, MI
Tel: 248-538-2250
Fax: 248-538-2260

Kokomo
Kokomo, IN
Tel: 765-864-8360
Fax: 765-864-8387

Los Angeles
Mission Viejo, CA
Tel: 949-462-9523
Fax: 949-462-9608

San Jose
Mountain View, CA
Tel: 650-215-1444
Fax: 650-961-0286

Toronto
Mississauga, Ontario,
Canada
Tel: 905-673-0699
Fax: 905-673-6509

ASIA/PACIFIC

Australia - Sydney
Tel: 61-2-9868-6733
Fax: 61-2-9868-6755

China - Beijing
Tel: 86-10-8528-2100
Fax: 86-10-8528-2104

China - Chengdu
Tel: 86-28-8676-6200
Fax: 86-28-8676-6599

China - Fuzhou
Tel: 86-591-8750-3506
Fax: 86-591-8750-3521

China - Hong Kong SAR
Tel: 852-2401-1200
Fax: 852-2401-3431

China - Qingdao
Tel: 86-532-8502-7355
Fax: 86-532-8502-7205

China - Shanghai
Tel: 86-21-5407-5533
Fax: 86-21-5407-5066

China - Shenyang
Tel: 86-24-2334-2829
Fax: 86-24-2334-2393

China - Shenzhen
Tel: 86-755-8203-2660
Fax: 86-755-8203-1760

China - Shunde
Tel: 86-757-2839-5507
Fax: 86-757-2839-5571

China - Wuhan
Tel: 86-27-5980-5300
Fax: 86-27-5980-5118

China - Xian
Tel: 86-29-8833-7250
Fax: 86-29-8833-7256

ASIA/PACIFIC

India - Bangalore
Tel: 91-80-2229-0061
Fax: 91-80-2229-0062

India - New Delhi
Tel: 91-11-5160-8631
Fax: 91-11-5160-8632

India - Pune
Tel: 91-20-2566-1512
Fax: 91-20-2566-1513

Japan - Yokohama
Tel: 81-45-471-6166
Fax: 81-45-471-6122

Korea - Gumi
Tel: 82-54-473-4301
Fax: 82-54-473-4302

Korea - Seoul
Tel: 82-2-554-7200
Fax: 82-2-558-5932 or
82-2-558-5934

Malaysia - Penang
Tel: 604-646-8870
Fax: 604-646-5086

Philippines - Manila
Tel: 632-634-9065
Fax: 632-634-9069

Singapore
Tel: 65-6334-8870
Fax: 65-6334-8850

Taiwan - Hsin Chu
Tel: 886-3-572-9526
Fax: 886-3-572-6459

Taiwan - Kaohsiung
Tel: 886-7-536-4818
Fax: 886-7-536-4803

Taiwan - Taipei
Tel: 886-2-2500-6610
Fax: 886-2-2508-0102

Thailand - Bangkok
Tel: 66-2-694-1351
Fax: 66-2-694-1350

EUROPE

Austria - Weis
Tel: 43-7242-2244-399
Fax: 43-7242-2244-393

Denmark - Copenhagen
Tel: 45-4450-2828
Fax: 45-4485-2829

France - Paris
Tel: 33-1-69-53-63-20
Fax: 33-1-69-30-90-79

Germany - Munich
Tel: 49-89-627-144-0
Fax: 49-89-627-144-44

Italy - Milan
Tel: 39-0331-742611
Fax: 39-0331-466781

Netherlands - Drunen
Tel: 31-416-690399
Fax: 31-416-690340

Spain - Madrid
Tel: 34-91-352-30-52
Fax: 34-91-352-11-47

UK - Wokingham
Tel: 44-118-921-5869
Fax: 44-118-921-5820

