



Chipsmall Limited consists of a professional team with an average of over 10 year of expertise in the distribution of electronic components. Based in Hongkong, we have already established firm and mutual-benefit business relationships with customers from,Europe,America and south Asia,supplying obsolete and hard-to-find components to meet their specific needs.

With the principle of “Quality Parts,Customers Priority,Honest Operation,and Considerate Service”,our business mainly focus on the distribution of electronic components. Line cards we deal with include Microchip,ALPS,ROHM,Xilinx,Pulse,ON,Everlight and Freescale. Main products comprise IC,Modules,Potentiometer,IC Socket,Relay,Connector.Our parts cover such applications as commercial,industrial, and automotives areas.

We are looking forward to setting up business relationship with you and hope to provide you with the best service and solution. Let us make a better world for our industry!



Contact us

Tel: +86-755-8981 8866 Fax: +86-755-8427 6832

Email & Skype: info@chipsmall.com Web: www.chipsmall.com

Address: A1208, Overseas Decoration Building, #122 Zhenhua RD., Futian, Shenzhen, China



Three-Channel Analog Front-End Device

Device Features:

- Three input pins for analog input signals
- High input detection sensitivity (3 mV_{PP}, typical)
- High modulation depth sensitivity (as low as 8%)
- Three output selections:
 - Demodulated data
 - Carrier clock
 - RSSI
- Input carrier frequency: 125 kHz, typical
- Input data rate: 10 Kbps, maximum
- 8 internal Configuration registers
- Bidirectional transponder communication (LF talk back)
- Programmable antenna tuning capacitance (up to 63 pF, 1 pF/step)
- Programmable output enable filter
- Low standby current: 4 μA (with 3 channels enabled), typical
- Low operating current: 13 μA (with 3 channels enabled), typical
- Serial Peripheral Interface (SPI™) with external devices
- Supports Battery Back-Up mode and batteryless operation with external circuits
- Industrial and Extended Temperature Range: -40°C to +85°C (industrial)

Typical Applications:

- Automotive industry applications:
 - Passive Keyless Entry (PKE) transponder
 - Remote door locks and gate openers
 - Engine immobilizer
 - LF initiator sensor for tire pressure monitoring systems
- Security Industry applications:
 - Long range access control transponder
 - Parking lot entry transponder
 - Hands-free apartment door access
 - Asset control and management

Description:

The MCP2030 is a stand-alone Analog Front-End (AFE) device for Low-Frequency (LF) sensing and bidirectional communication applications. The device has eight internal Configuration registers which are readable and programmable, except the read-only STATUS register, by an external device.

The device has three low-frequency input channels. Each input channel can be individually enabled or disabled. The device can detect an input signal with amplitude as low as ~1 mV_{PP} and can demodulate an amplitude-modulated input signal with as low as 8% modulation depth. The device can also transmit data by clamping and unclamping the input LC antenna voltage.

The device can output demodulated data, carrier clock or RSSI current depending on the register setting. The demodulated data and carrier clock outputs are available on the LFDATA pin, while the RSSI output is available on the RSSI pin. The RSSI current output is linearly proportional to the input signal strength.

The device has programmable internal tuning capacitors for each input channel. The user can program these capacitors up to 63 pF, 1 pF per step. These internal tuning capacitors can be used effectively for fine-tuning of the external LC resonant circuit.

The device is optimized for very low current consumption and has various battery-saving low-power modes (Sleep, Standby, Active). The device can also be operated in Battery Back-up and Batteryless modes using a few external components.

This device is available in 14-pin PDIP, SOIC, and TSSOP packages. This device is also used as the AFE in the PIC16F639.

Package Types:

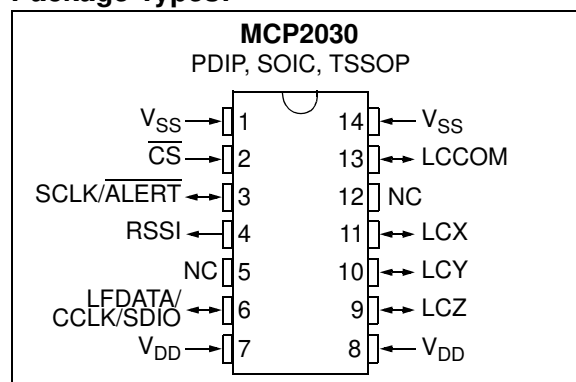

MCP2030

NOTES:

1.0 ELECTRICAL SPECIFICATIONS

Absolute Maximum Ratings^(†)

| | |
|--|-----------------------------------|
| Ambient temperature under bias..... | -40°C to +125°C |
| Storage temperature | -65°C to +150°C |
| Voltage on V _{DD} with respect to V _{SS} | -0.3V to +6.5V |
| Voltage on all other pins with respect to V _{SS} | -0.3V to (V _{DD} + 0.3V) |
| Maximum current out of V _{SS} pin | 300 mA |
| Maximum current into V _{DD} pin | 250 mA |
| Maximum LC Input Voltage (LCX, LCY, LCZ) loaded, with device..... | 10.0 V _{PP} |
| Maximum LC Input Voltage (LCX, LCY, LCZ) unloaded, without device..... | 700.0 V _{PP} |
| Maximum Input Current (rms) into device per LC Channel..... | 10 mA |
| Human Body ESD rating..... | 2000 (min.) V |
| Machine Model ESD rating | 200 (min.) V |

† **Notice:** Stresses above those listed under “Maximum Ratings” may cause permanent damage to the device. This is a stress rating only and functional operation of the device at those or any other conditions above those indicated in the operation listings of this specification is not implied. Exposure to maximum rating conditions for extended periods may affect device reliability.

DC Characteristics

| Electrical Specifications: Standard Operating Conditions (unless otherwise stated) | | | | | | |
|---|--------------------|---------------------------------|-------------|-----------------------|----------------|---|
| Operating temperature | | -40°C ≤ T _A ≤ +85°C | | | | |
| LC Signal Input | | Sinusoidal 300 mV _{PP} | | | | |
| Carrier Frequency | | 125 kHz | | | | |
| LCCOM connected to V _{SS} | | | | | | |
| Parameters | Sym. | Min. | Typ† | Max. | Units | Conditions |
| Supply Voltage | V _{DD} | 2.0 | 3.0 | 3.6 | V | |
| V _{DD} Start Voltage to ensure internal Power-on Reset signal | V _{POR} | — | — | 1.8 | V | |
| Modulation Transistor-on Resistance | R _M | — | 50 | 100 | Ω | V _{DD} = 3.0V |
| Active Current (detecting signal) 1 LC Input Channel Receiving Signal 3 LC Input Channel Receiving Signals | I _{ACT} | — | 10 13 | — 18 | μA μA | $\overline{CS} = V_{DD}$ Input = Continuous Wave (CW); Amplitude = 300 mV _{PP} All channels enabled. |
| Standby Current (wait to detect signal) 1 LC Input Channel Enabled 2 LC Input Channels Enabled 3 LC Input Channels Enabled | I _{STDBY} | — | 2 3 4 | 5 6 7 | μA μA μA | $\overline{CS} = V_{DD}$; $\overline{ALERT} = V_{DD}$ |
| Sleep Current | I _{SLEEP} | — | 0.2 | 1 | μA | $\overline{CS} = V_{DD}$; $\overline{ALERT} = V_{DD}$ |
| Analog Input Leakage Current LCX, LCY, LCZ LCCOM | I _{AIL} | — | — | ± 1 ± 1 | μA μA | V _{DD} = 3.6V, V _{SS} ≤ V _{IN} ≤ 1V with respect to ground. Internal tuning capacitors are switched off, tested in Sleep mode. |
| Digital Input Low Voltage | V _{IL} | V _{SS} | — | 0.3 V _{DD} | V | SCLK, SDI, \overline{CS} |
| Digital Input High Voltage | V _{IH} | 0.8 V _{DD} | — | V _{DD} | V | SCLK, SDI, \overline{CS} |
| Digital Input Leakage Current (Note 1) SDI SCLK, \overline{CS} | I _{IL} | — | — | ± 1 ± 1 | μA μA | V _{DD} = 3.6V V _{SS} ≤ V _{PIN} ≤ V _{DD} V _{PIN} ≤ V _{DD} |
| Digital Output Low Voltage ALERT, LFDATA/SDIO | V _{OL} | — | — | V _{SS} + 0.4 | V | Analog Front-End section I _{OL} = 1.0 mA, V _{DD} = 2.0V |
| Digital Output High Voltage ALERT, LFDATA/SDIO | V _{OH} | V _{DD} - 0.5 | — | — | V | I _{OH} = -400 μA, V _{DD} = 2.0V |
| Digital Input Pull-Up Resistor CS, SCLK | R _{PU} | 50 | 200 | 350 | kΩ | V _{DD} = 3.6V |

* These parameters are characterized but not tested.

† Data in “Typ” column is at 3.0V, +25°C unless otherwise stated. These parameters are for design guidance only and are not tested.

Note 1: Negative current is defined as current sourced by the pin.

MCP2030

AC Characteristics

| Electrical Specifications: Standard Operating Conditions (unless otherwise stated) | | | | | | |
|--|---------------------------------|------------------|---------------------|----------------|------------------|--|
| Supply Voltage | 2.0V ≤ V _{DD} ≤ 3.6V | | | | | |
| Operating temperature | -40°C ≤ T _A ≤ +85°C | | | | | |
| LCCOM connected to V _{SS} | | | | | | |
| LC Signal Input | Sinusoidal 300 mV _{PP} | | | | | |
| Carrier Frequency | 125 kHz | | | | | |
| LCCOM connected to V _{SS} | | | | | | |
| Parameters | Sym. | Min. | Typ† | Max. | Units | Conditions |
| Input Sensitivity | V _{SENSE} | 1 | 3.0 | 6 | mV _{PP} | V _{DD} = 3.0V Output enable filter disabled AGCSIG = 0; MODMIN = 00 (33% modulation depth setting) Input = Continuous Wave (CW) Output = Logic level transition from low-to-high at sensitivity level for CW input. |
| Coil de-Q'ing Voltage - RF Limiter (R _{FLM}) must be active | V _{DE_Q} | 3 | — | 5 | V | V _{DD} = 3.0V, Force I _{IN} = 5 μA (worst case) |
| RF Limiter Turn-on Resistance (LCX, LCY, LCZ) | R _{FLM} | — | 300 | 700 | Ω | V _{DD} = 2.0V, V _{IN} = 8 V _{DC} |
| Sensitivity Reduction | S _{ADJ} | — — | 0 -30 | — — | dB dB | V _{DD} = 3.0V No sensitivity reduction selected Max. reduction selected Monotonic increment in attenuation value from setting = 0000 to 1111 by design |
| Minimum Modulation Depth 60% setting 33% setting 14% setting 8% | V _{IN_MOD} | — — — — | 60 33 14 8 | 84 49 26 | % % % % | V _{DD} = 3.0V See Section 5.21 "Minimum Modulation Depth Requirement for Input Signal". See Modulation Depth Definition in Figure 5-5. |
| Carrier frequency | F _{CARRIER} | — | 125 | — | kHz | |
| Input modulation frequency | F _{MOD} | — | — | 10 | kHz | Input data rate with NRZ data format. V _{DD} = 3.0V Minimum modulation depth setting = 33% Input conditions: Amplitude = 300 mV _{PP} Modulation depth = 100% |
| LCX Tuning Capacitor | C _{TUNX} | — 44 | 0 59 | — 82 | pF pF | V _{DD} = 3.0V, Config. Reg. 1, bits <6:1> Setting = 000000 63 pF ±30% Config. Reg. 1, bits <6:1> Setting = 111111 63 steps, approx. 1 pF/step Monotonic increment in capacitor value from setting = 000000 to 111111 by design |
| LCY Tuning Capacitor | C _{TUNY} | — 44 | 0 59 | — 82 | pF pF | V _{DD} = 3.0V, Config. Reg. 2, bits <6:1> Setting = 000000 63 pF ±30% Config. Reg. 2, bits <6:1> Setting = 111111 63 steps, approx. 1 pF/step Monotonic increment in capacitor value from setting = 000000 to 111111 by design |
| LCZ Tuning Capacitor | C _{TUNZ} | — 44 | 0 59 | — 82 | pF pF | V _{DD} = 3.0V, Config. Reg. 3, bits <6:1> Setting = 000000 63 pF ±30% Config. Reg. 3, bits <6:1> Setting = 111111 63 steps, approx. 1 pF/step Monotonic increment in capacitor value from setting = 000000 to 111111 by design |
| Q of Internal Tuning Capacitors | Q_C | 50 * | — | — | | |
| Demodulator Charge Time (delay time of demodulated output to rise) | T _{DR} | — | 50 | — | μs | V _{DD} = 3.0V Minimum modulation depth setting = 33% Input conditions: Amplitude = 300 mV _{PP} Modulation depth = 100% |

* Parameter is characterized but not tested.

† Data in "Typ" column is at 3.0V, 25°C unless otherwise stated. These parameters are for design guidance only and are not tested.

Note 1: Required output enable filter high time must account for input path analog delays (= T_{OEH} - T_{DR} + T_{DF}).

Note 2: Required output enable filter low time must account for input path analog delays (= T_{OEL} + T_{DR} - T_{DF}).

MCP2030

AC Characteristics (Continued)

| Electrical Specifications: Standard Operating Conditions (unless otherwise stated) | | | | | | |
|--|---|------|------|------|-------|---|
| Supply Voltage | $2.0V \leq V_{DD} \leq 3.6V$ | | | | | |
| Operating temperature | $-40^{\circ}C \leq T_A \leq +85^{\circ}C$ | | | | | |
| LCCOM connected to V_{SS} | | | | | | |
| LC Signal Input | Sinusoidal 300 mV _{PP} | | | | | |
| Carrier Frequency | 125 kHz | | | | | |
| LCCOM connected to V_{SS} | | | | | | |
| Parameters | Sym. | Min. | Typ† | Max. | Units | Conditions |
| RSSI current output | I _{RSSI} | — | 0.65 | 2 | μA | V _{IN} = 37 mV _{PP} V _{IN} = 370 mV _{PP} V _{DD} = 3.0V, V _{IN} = 0 to 4 V _{PP} Linearly increases with input signal amplitude. Tested at V _{IN} = 37 mV _{PP} , 100 mV _{PP} , and 370 mV _{PP} at +25°C. |
| | | 6 | 12 | 20.3 | μA | |
| | | — | 100 | — | μA | |
| RSSI current linearity | IL _{RSSI} | -15 | — | 15 | % | Tested at room temperature only (see Equation 5-1 and Figure 5-7 for test method). |

* Parameter is characterized but not tested.

† Data in "Typ" column is at 3.0V, 25°C unless otherwise stated. These parameters are for design guidance only and are not tested.

- Note**
- 1: Required output enable filter high time must account for input path analog delays ($= T_{OE\bar{H}} - T_{DR} + T_{DF}$).
 - 2: Required output enable filter low time must account for input path analog delays ($= T_{OEL} + T_{DR} - T_{DF}$).

SPI Timing

| Electrical Specifications: Standard Operating Conditions (unless otherwise stated) | | | | | | |
|--|---|------|------|------|-------|---|
| Supply Voltage | $2.0V \leq V_{DD} \leq 3.6V$ | | | | | |
| Operating temperature | $-40^{\circ}C \leq T_A \leq +85^{\circ}C$ | | | | | |
| LC Signal Input | Sinusoidal 300 mV _{PP} | | | | | |
| Carrier Frequency | 125 kHz | | | | | |
| LCCOM connected to V_{SS} | | | | | | |
| Parameters | Sym. | Min. | Typ† | Max. | Units | Conditions |
| SCLK Frequency | F _{SCLK} | — | — | 3 | MHz | |
| \overline{CS} fall to first SCLK edge setup time | T _{CSSC} | 100 | — | — | ns | |
| SDI setup time | T _{SU} | 30 | — | — | ns | |
| SDI hold time | T _{HD} | 50 | — | — | ns | |
| SCLK high time | T _{HI} | 150 | — | — | ns | |
| SCLK low time | T _{LO} | 150 | — | — | ns | |
| SDO setup time | T _{DO} | — | — | 150 | ns | |
| SCLK last edge to \overline{CS} rise setup time | T _{SCCS} | 100 | — | — | ns | |
| \overline{CS} high time | T _{C\overline{S}H} | 500 | — | — | ns | |
| \overline{CS} rise to SCLK edge setup time | T _{CS1} | 50 | — | — | ns | |
| SCLK edge to \overline{CS} fall setup time | T _{CS0} | 50 | — | — | ns | SCLK edge when \overline{CS} is high |
| Rise time of SPI data (SPI Read command) | T _{R\overline{S}P} | — | 10 | — | ns | V _{DD} = 3.0V. Time is measured from 10% to 90% of amplitude |
| Fall time of SPI data (SPI Read command) | T _{F\overline{S}P} | — | 10 | — | ns | V _{DD} = 3.0V. Time is measured from 90% to 10% of amplitude |

† Data in "Typ" column is at 3.0V, 25°C unless otherwise stated. These parameters are for design guidance only and are not tested.

2.0 TYPICAL PERFORMANCE CURVES

Note: The graphs and tables provided following this note are a statistical summary based on a limited number of samples and are provided for informational purposes only. The performance characteristics listed herein are not tested or guaranteed. In some graphs or tables, the data presented may be outside the specified operating range (e.g., outside specified power supply range) and therefore outside the warranted range.

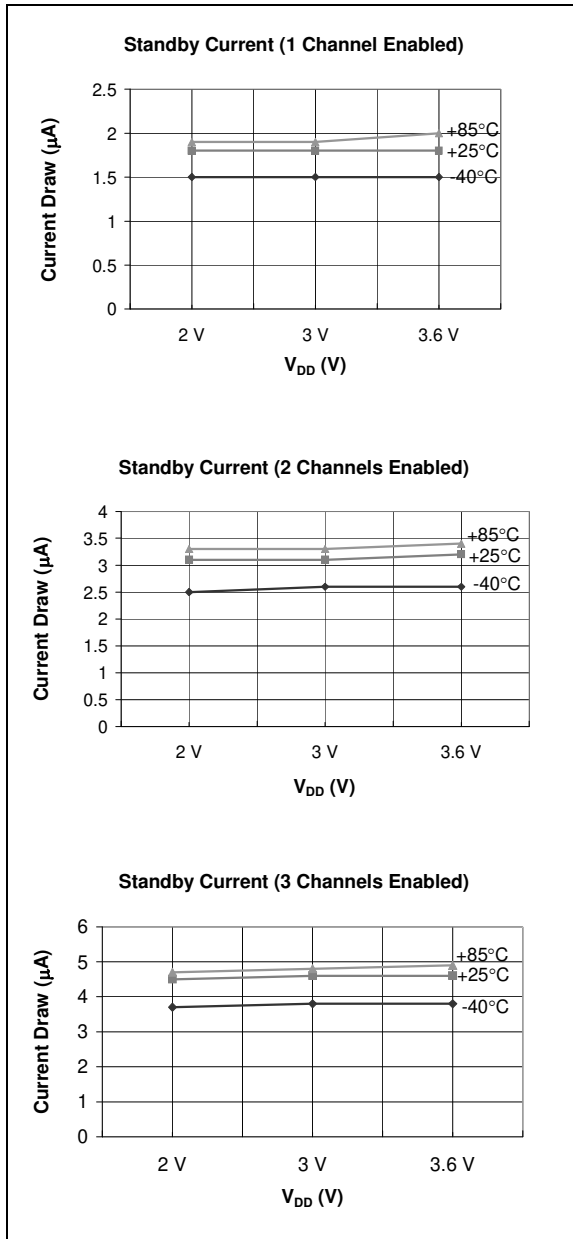

FIGURE 2-1: Typical Standby Current.

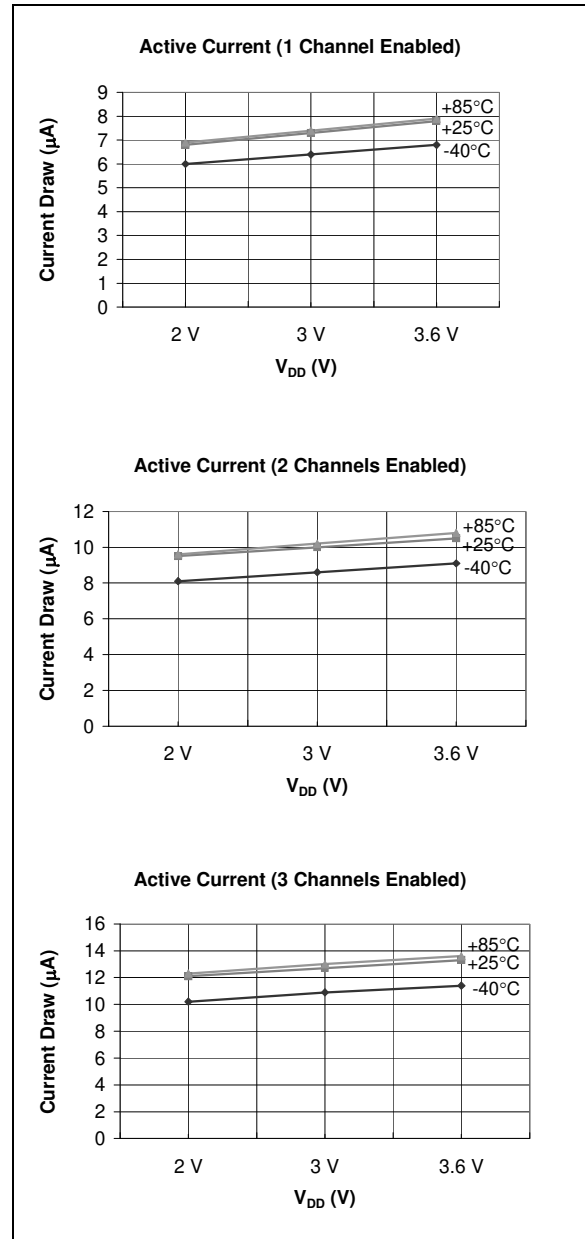

FIGURE 2-2: Typical Active Current.

MCP2030

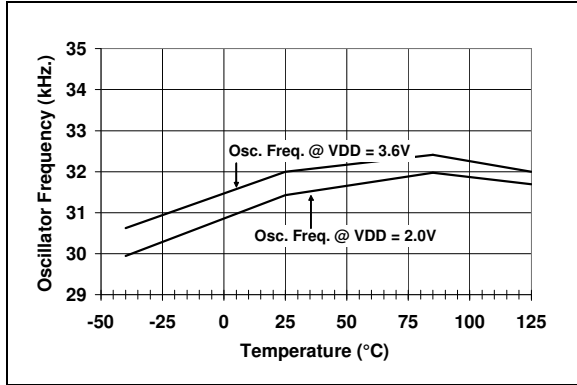

FIGURE 2-3: Oscillator Frequency vs. Temperature, $V_{DD} = 3.6V$ and $2.0V$.

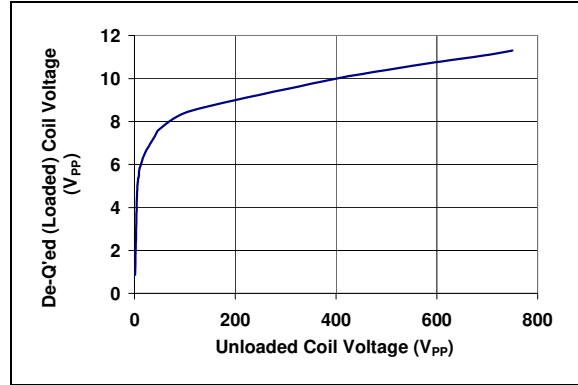

FIGURE 2-6: De-Q'ed Voltage vs. Unloaded Coil Voltage.

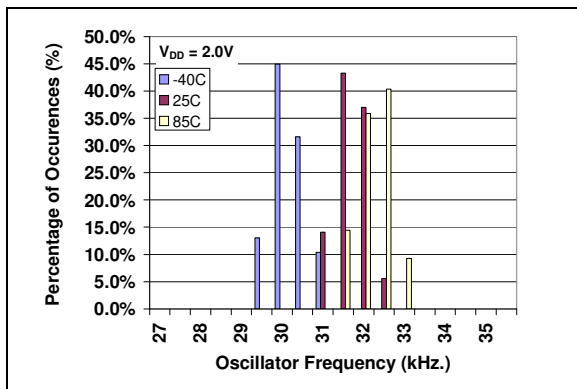

FIGURE 2-4: Oscillator Frequency Histograms vs. Temperature, $V_{DD} = 2V$.

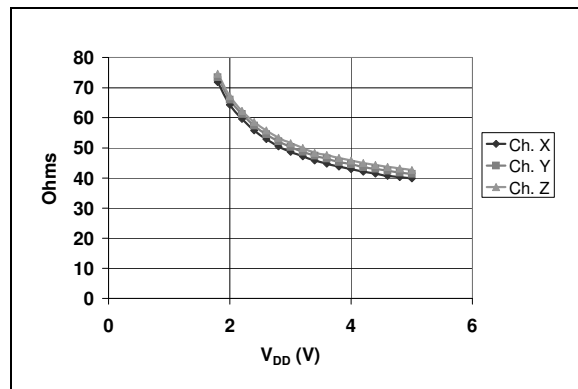

FIGURE 2-7: Modulation Transistor-on Resistance ($+25^{\circ}C$).

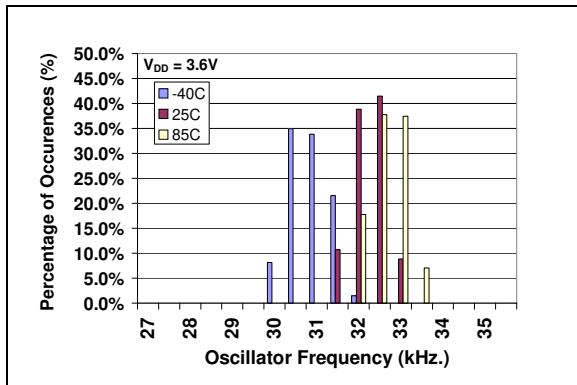

FIGURE 2-5: Oscillator Frequency Histograms vs. Temperature at $V_{DD} = 3V$.

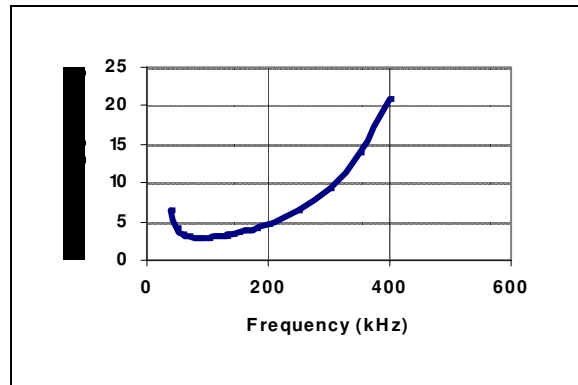

FIGURE 2-8: Channel Sensitivity vs. Bandwidth.

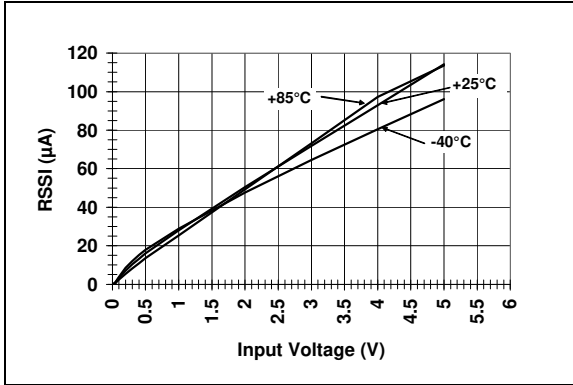

FIGURE 2-9: Typical RSSI Output Current vs. Input Signal Strength.

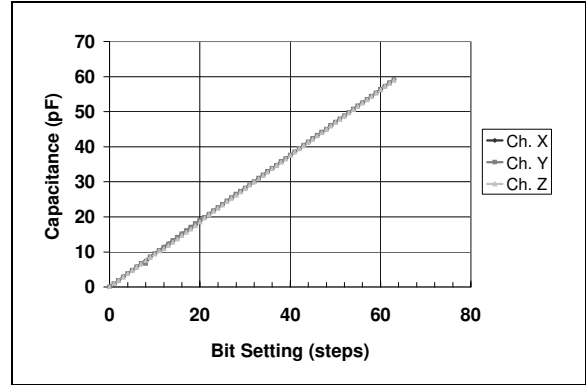

FIGURE 2-11: Typical Tuned Capacitance Value vs. Configuration Register Bit Setting ($V_{DD} = 3V$, Temperature = $-40^{\circ}C$).

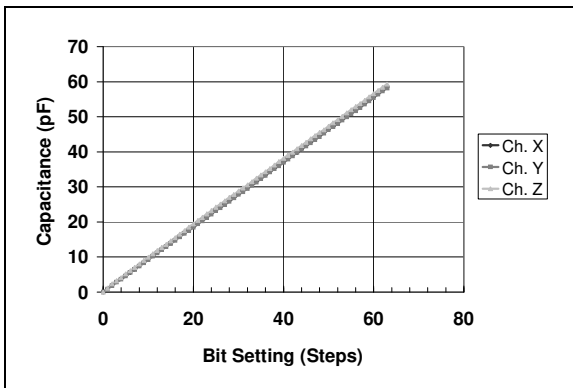

FIGURE 2-10: Typical Tuned Capacitance Value vs. Configuration Register Bit Setting ($V_{DD} = 3V$, Temperature = $+25^{\circ}C$).

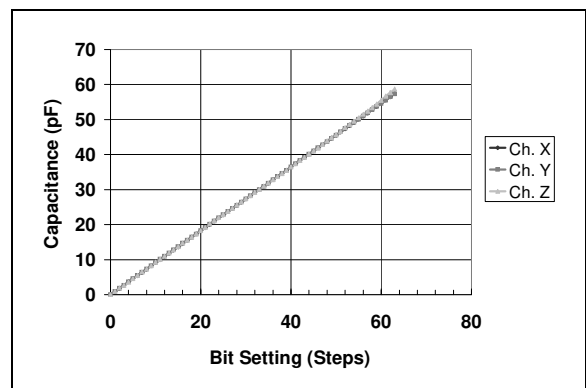

FIGURE 2-12: Typical Tuned Capacitance Value vs. Configuration Register Bit Setting ($V_{DD} = 3V$, Temperature = $+85^{\circ}C$).

MCP2030

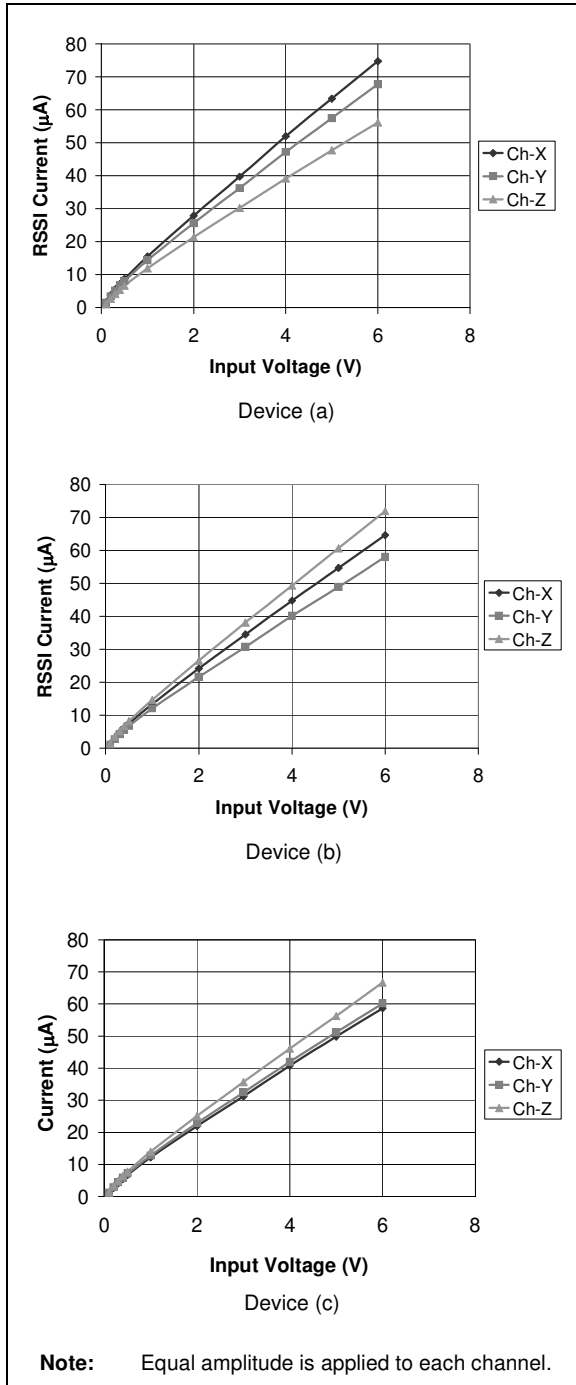

FIGURE 2-13: Examples of RSSI Output Current Variations Between Channel to Channel and Device to Device at Room Temperature.

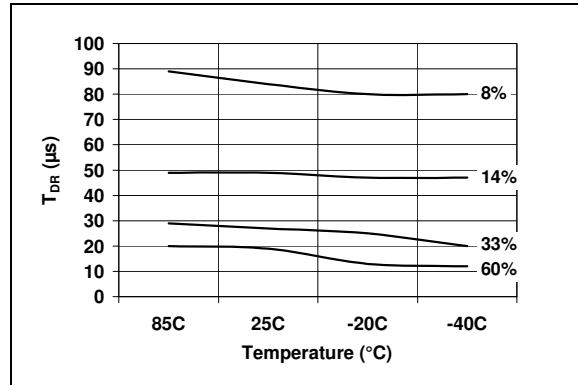

FIGURE 2-14: Example of Typical T_{DR} Changes over Temperature. Input Signal Condition: Amplitude = 300 mV_{PP}, Modulation Depth = 100 %.

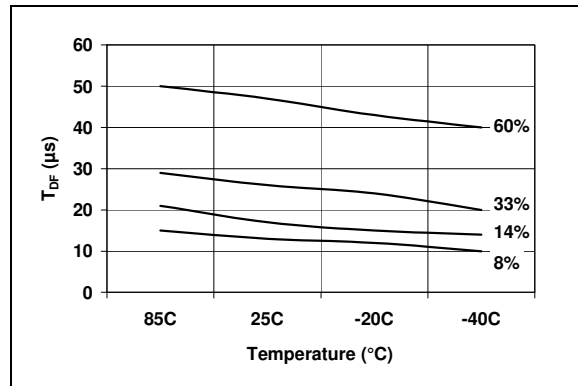

FIGURE 2-15: Example of Typical T_{DF} Changes over Temperature. Input Signal Condition: Amplitude = 300 mV_{PP}, Modulation Depth = 100 %.

2.1 Performance Plots

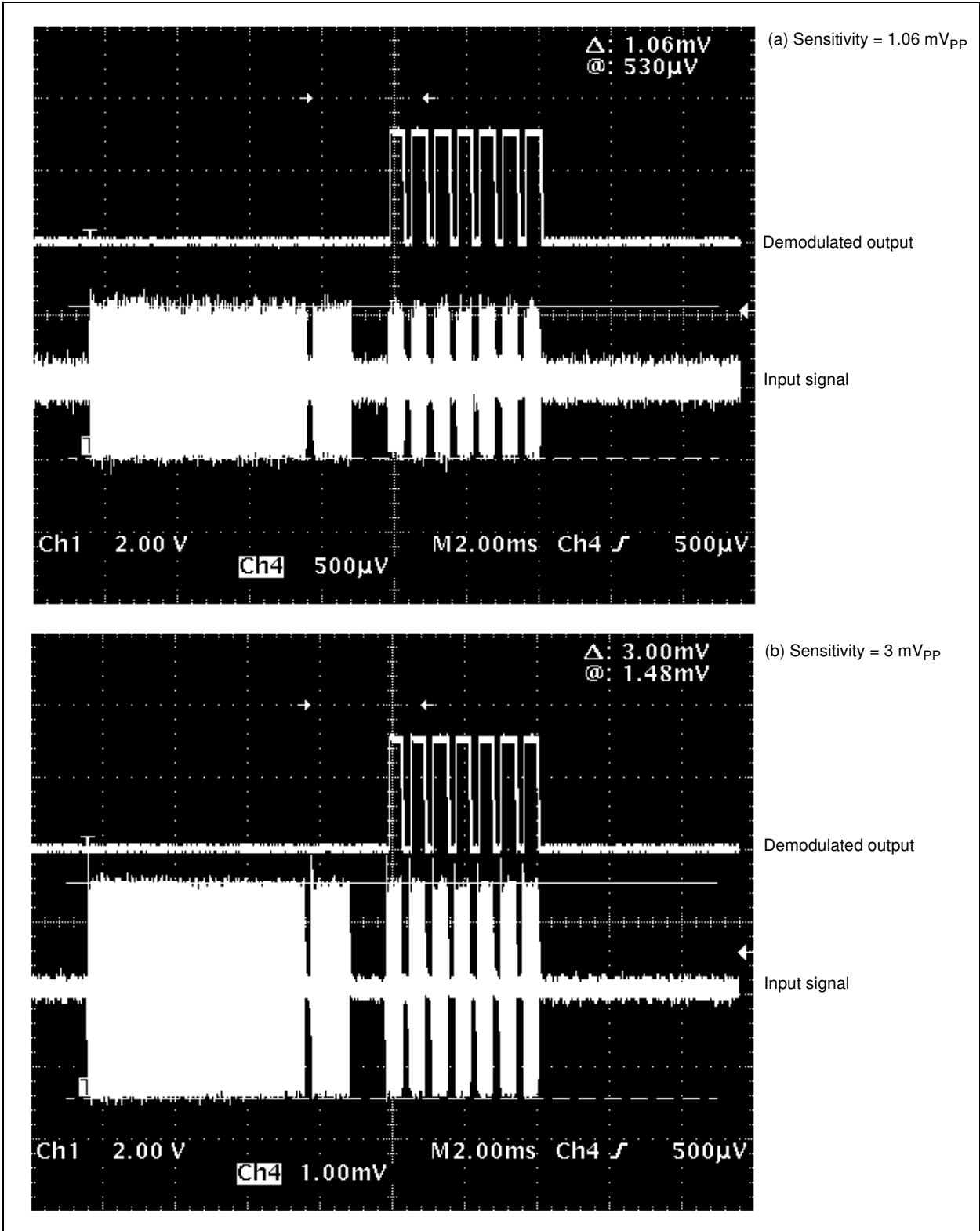

FIGURE 2-16: Input Sensitivity Example.

MCP2030

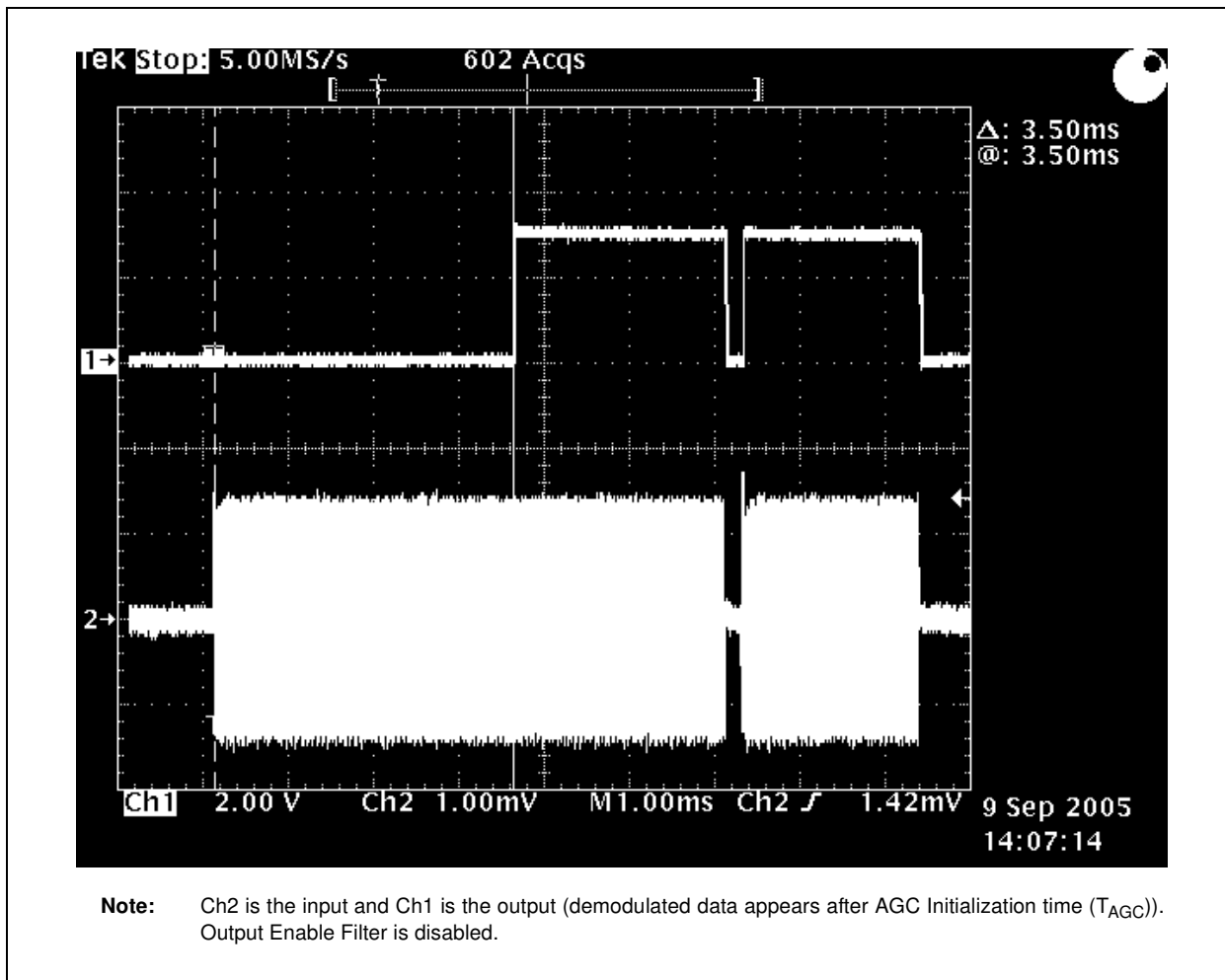

FIGURE 2-17: Typical AGC Initialization Time at Room Temperature ($V_{DD} = 3V$).

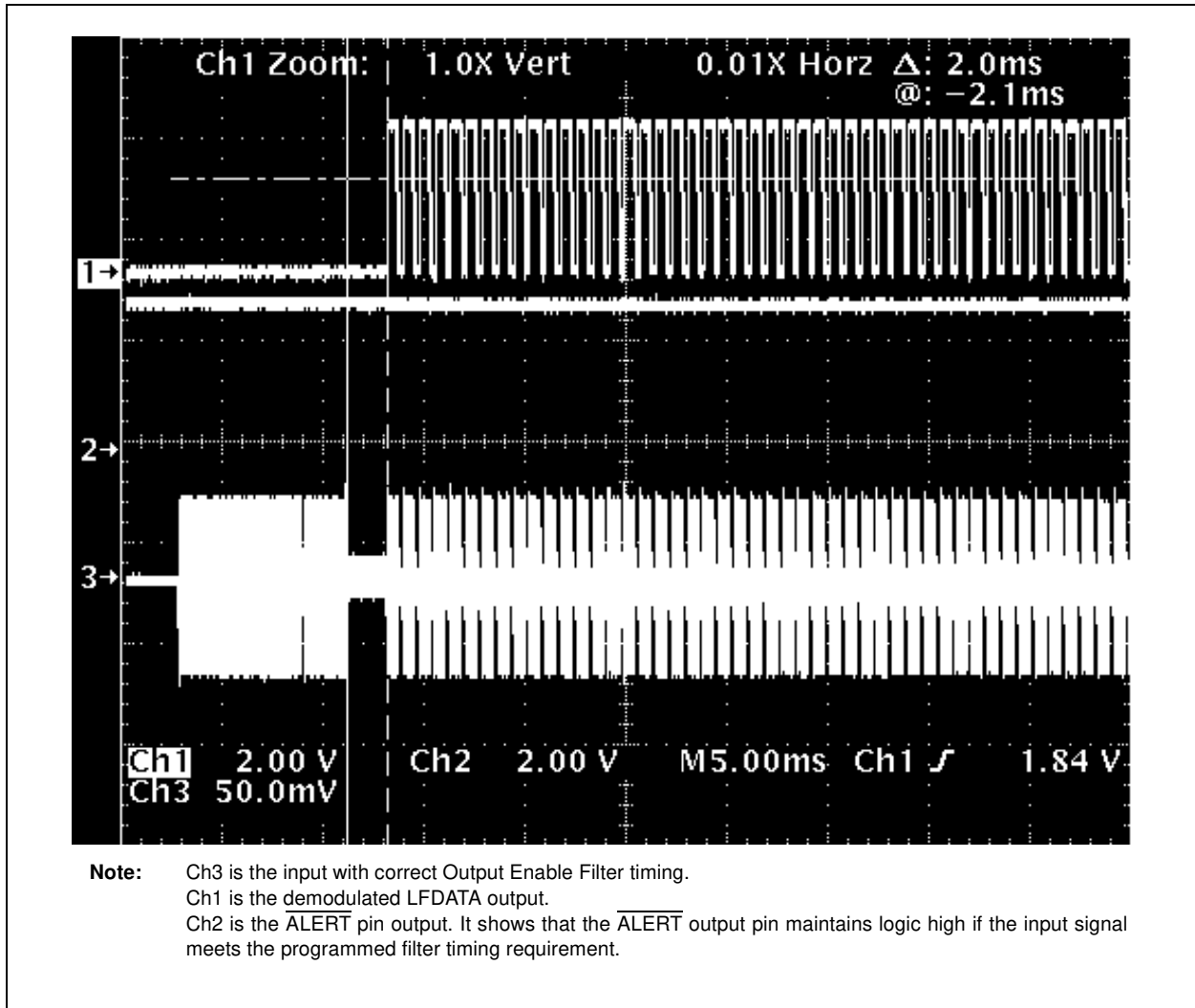

FIGURE 2-18: ALERT Output Example: With No Parity Error and no 32 ms Alarm Timer Time-out.

MCP2030

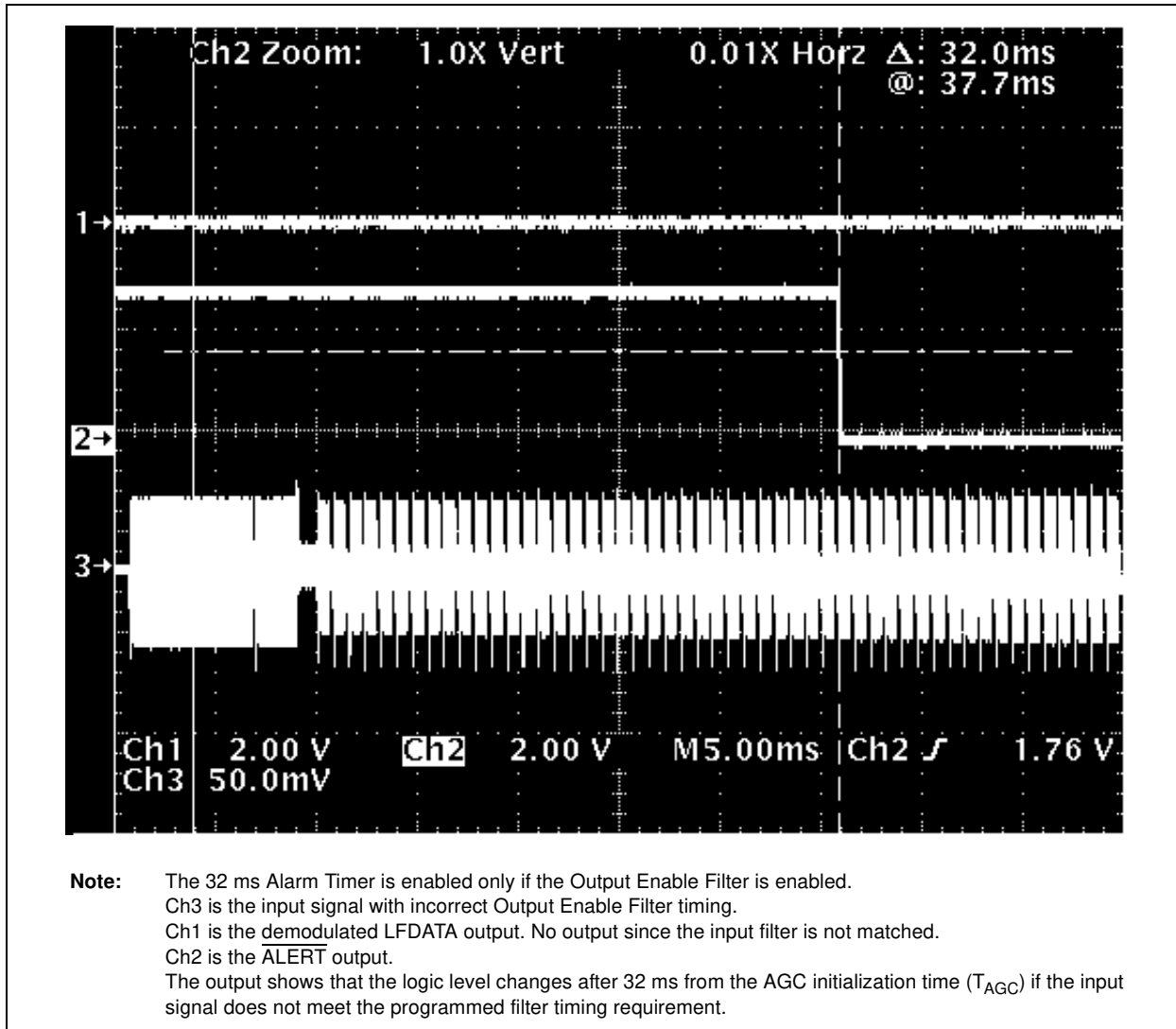

FIGURE 2-19: ALERT Output Example: With 32 ms Alarm Timer Timed out.

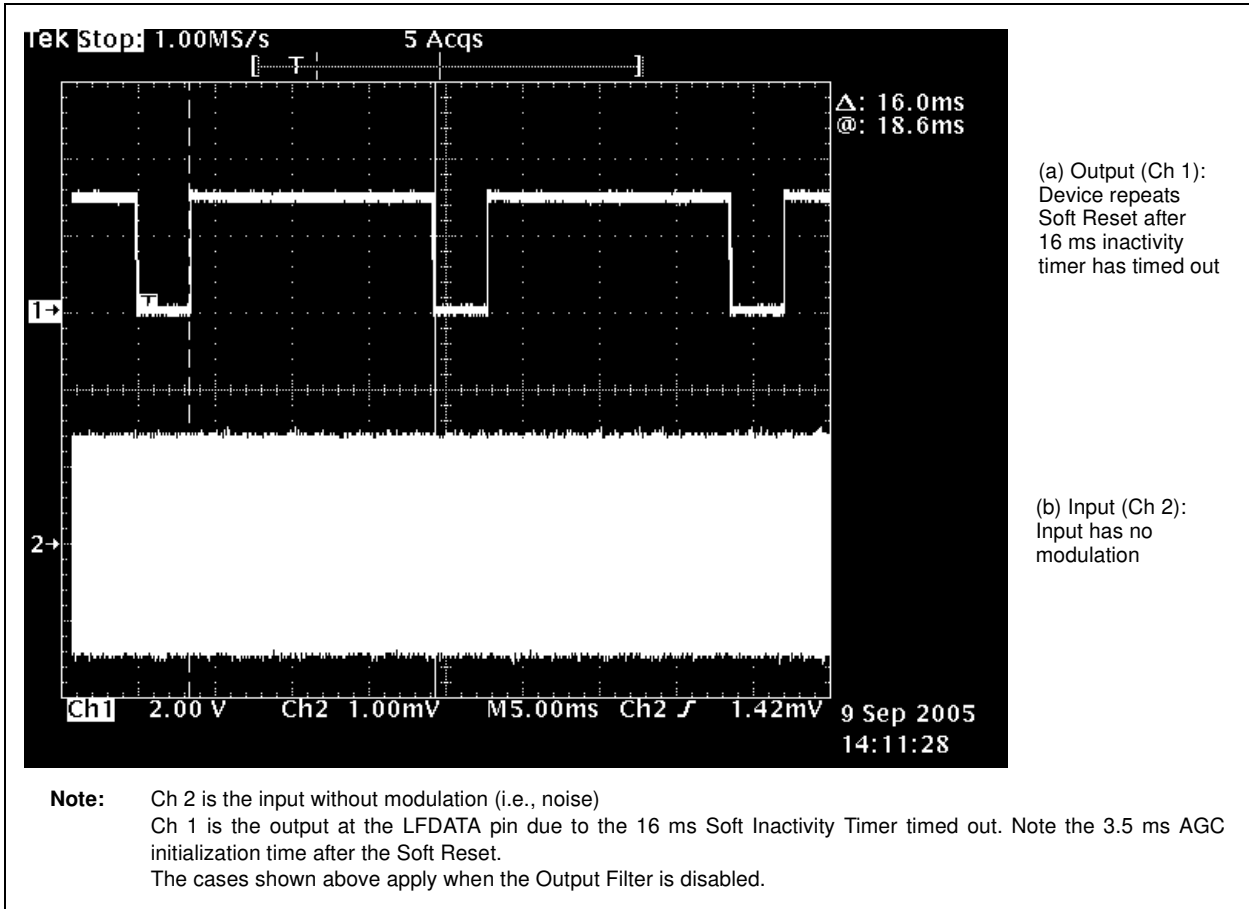

FIGURE 2-20: Examples of Soft Inactivity Timer Timed out: This output is available only if the Output Enable Filter is disabled.

MCP2030

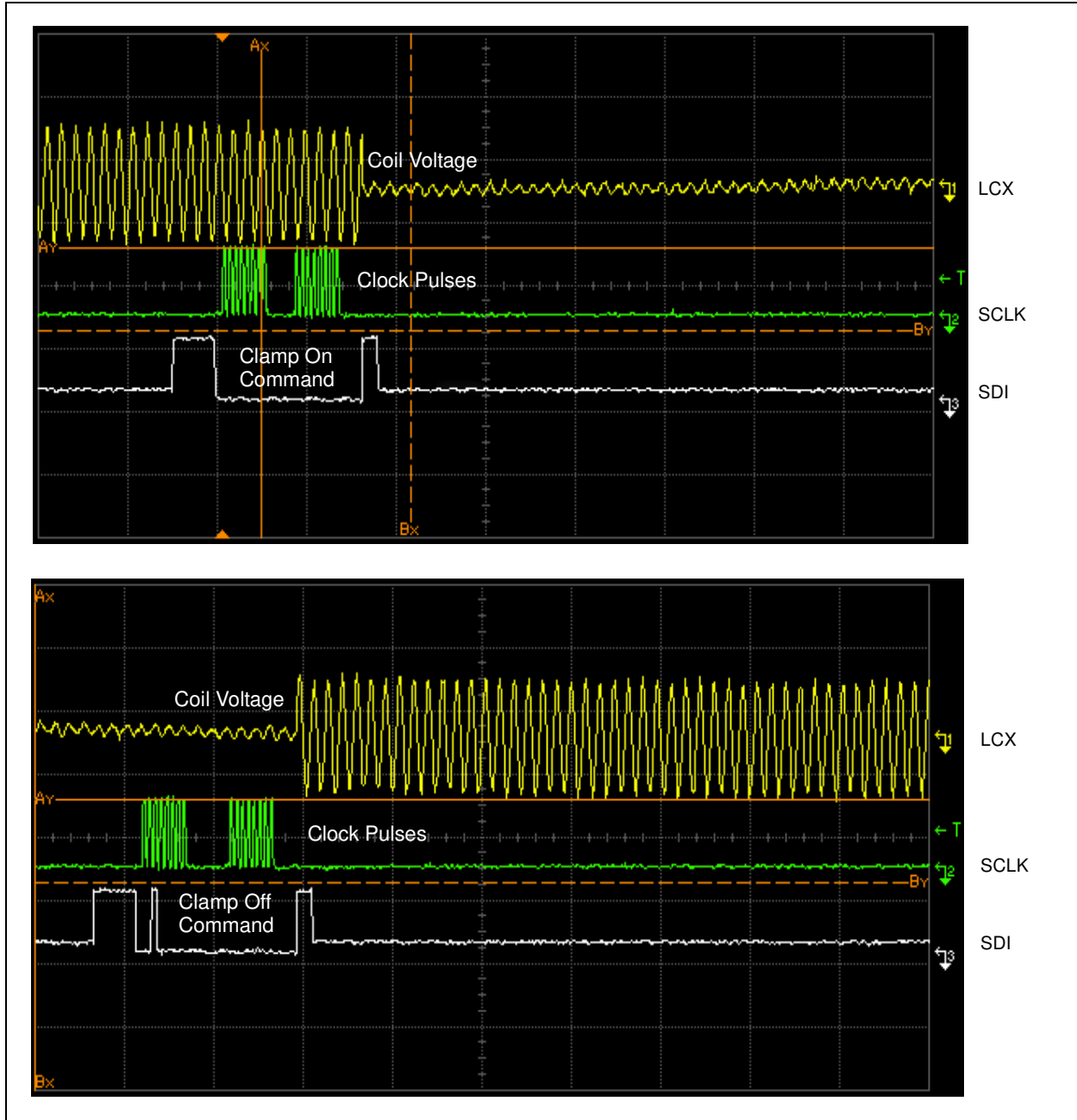

FIGURE 2-21: Examples of Clamp-On and Clamp-Off Commands and Changes in Coil Voltage.

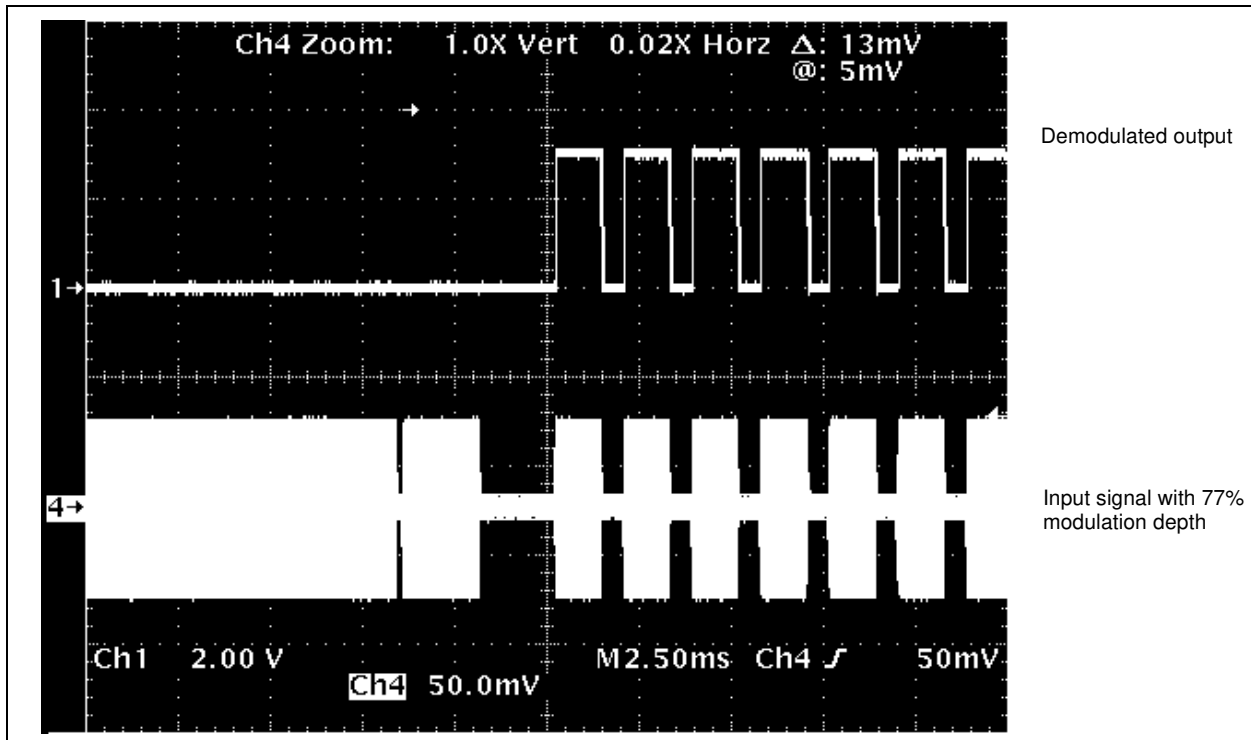

FIGURE 2-22: Example of Minimum Modulation Depth Setting: Modulation Depth of Input Signal = 77%, Minimum Modulation Depth (MODMIN) Setting = 60%.

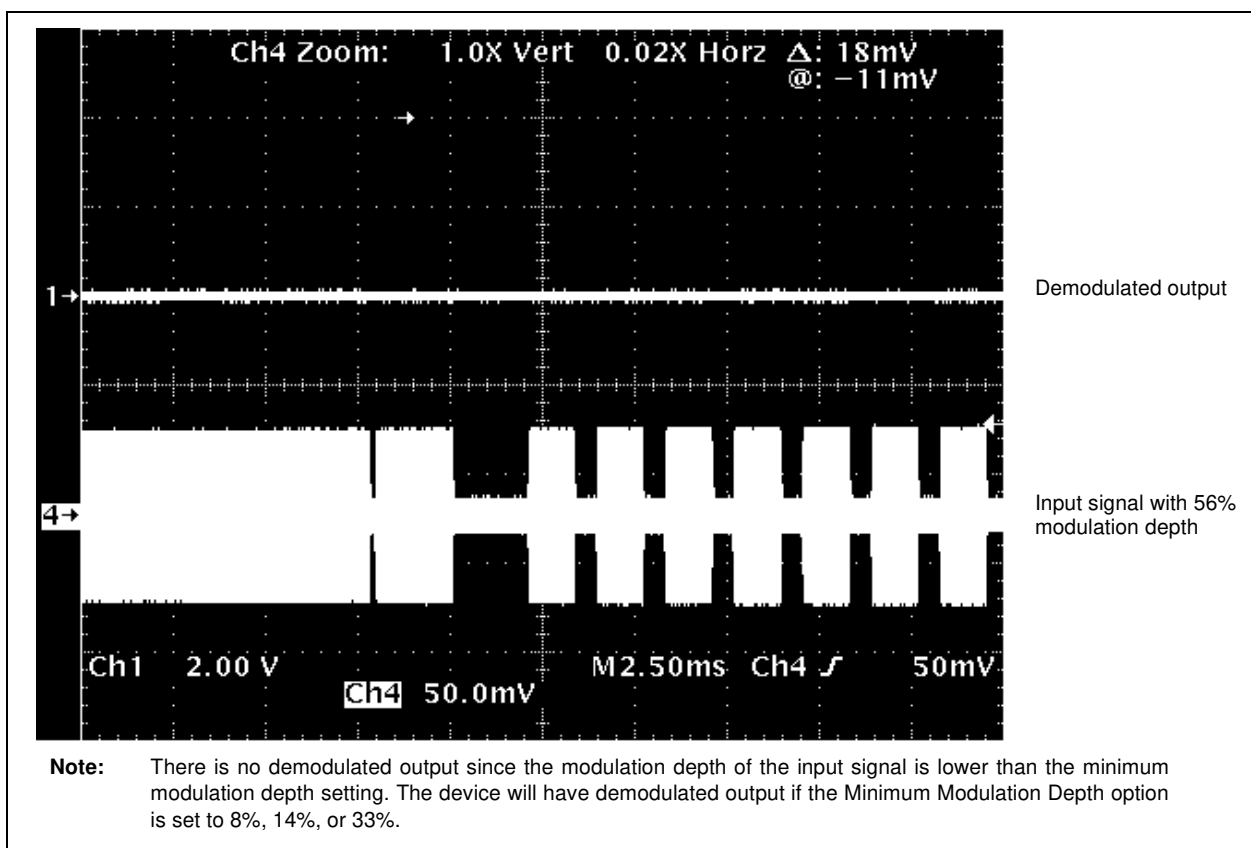

FIGURE 2-23: Example of Minimum Modulation Depth Setting: Modulation Depth of Input Signal = 56%, Minimum Modulation Depth (MODMIN) Setting = 60%.

MCP2030

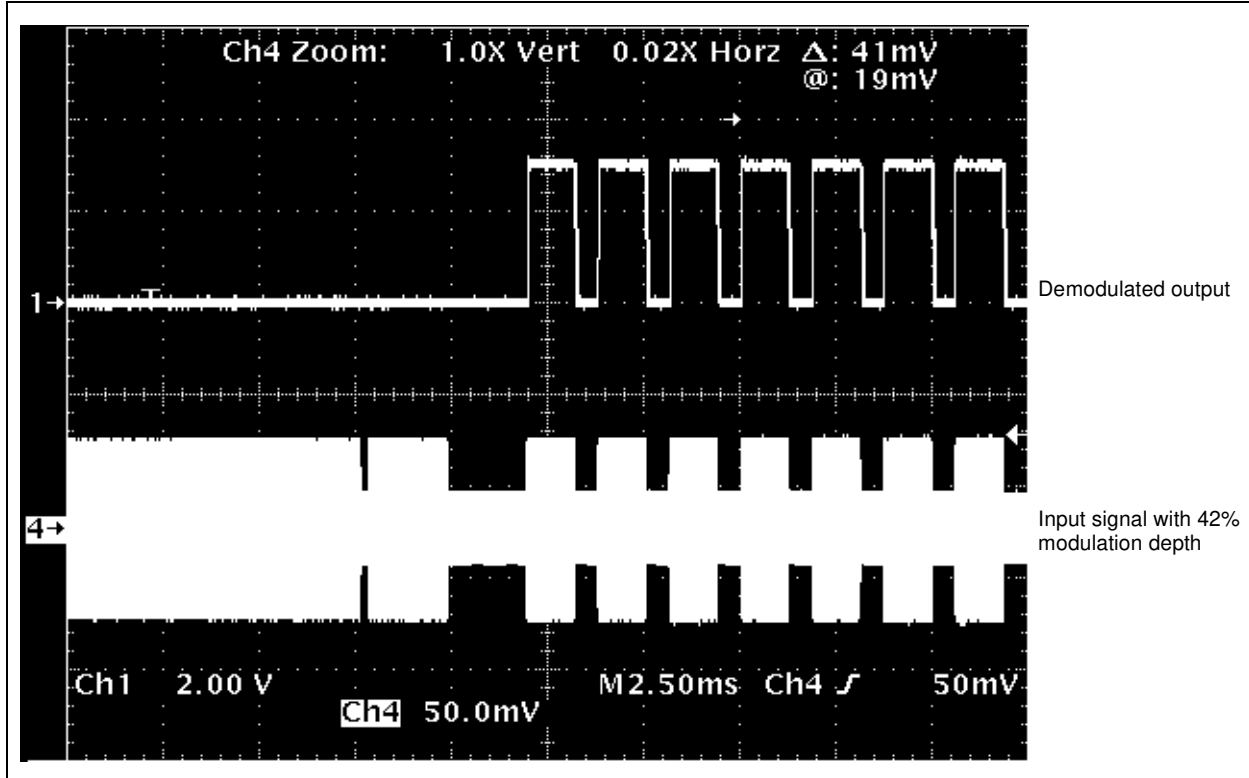

FIGURE 2-24: Example of Minimum Modulation Depth Setting: Modulation Depth of Input Signal = 42%, Minimum Modulation Depth (MODMIN) Setting = 33%.

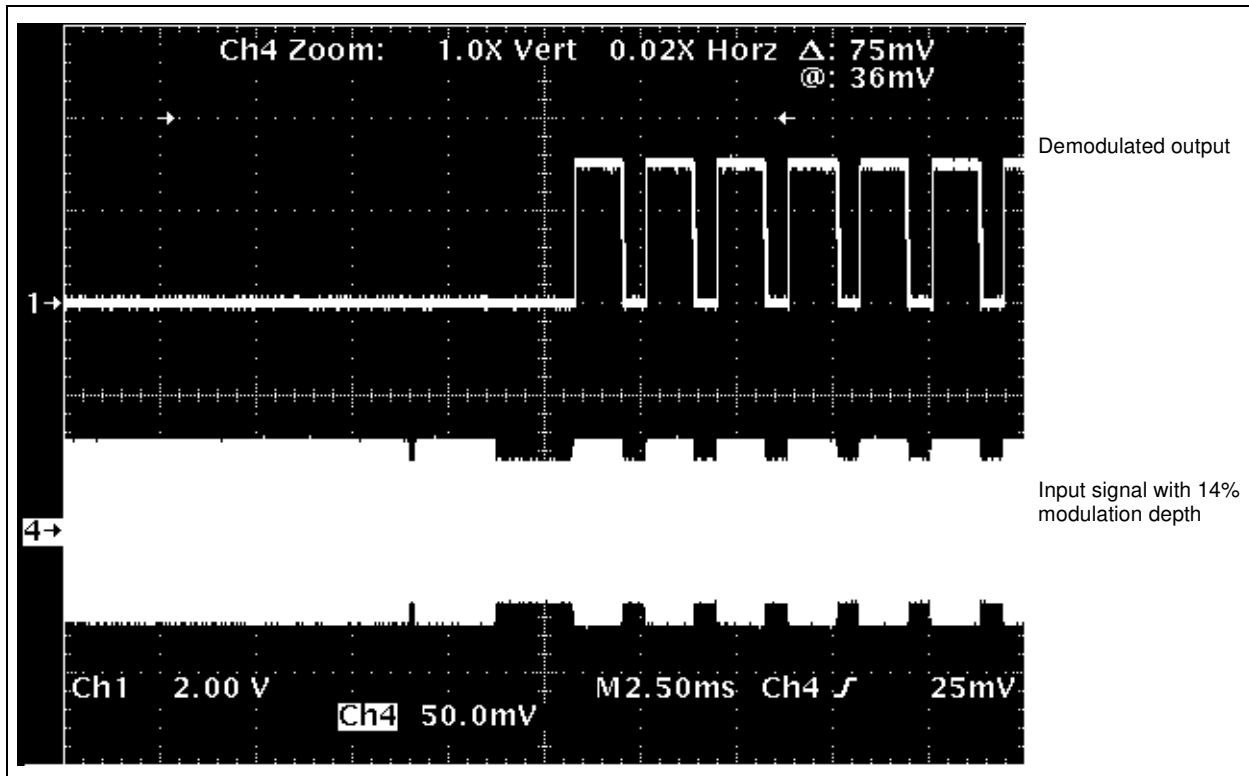

FIGURE 2-25: Example of Minimum Modulation Depth Setting: Modulation Depth of Input Signal = 14%, Minimum Modulation Depth (MODMIN) Setting = 14%.

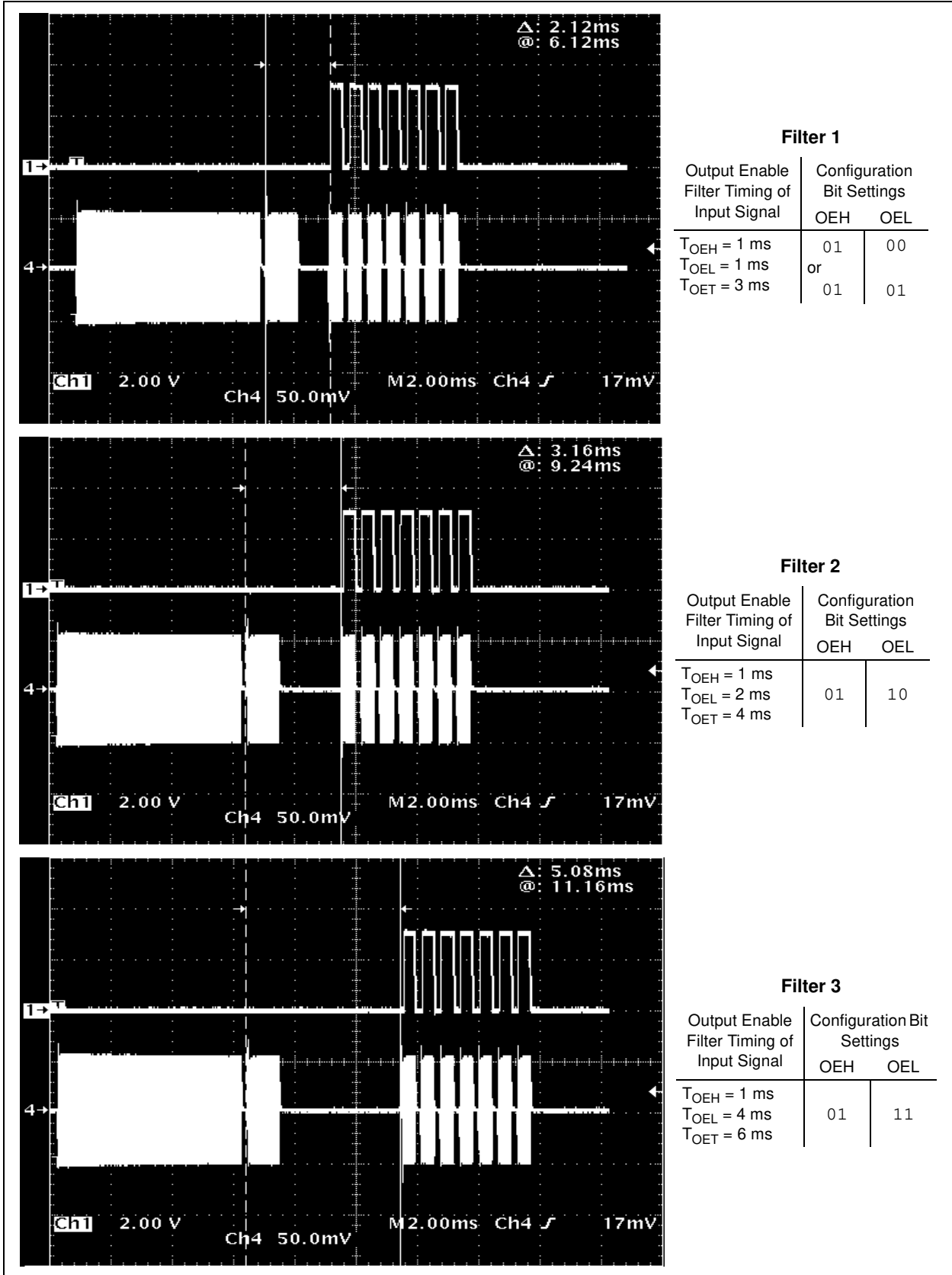

FIGURE 2-26: Examples of Output Enable Filters 1 through 3 (Wake-up Filters) and Demodulated Outputs.

MCP2030

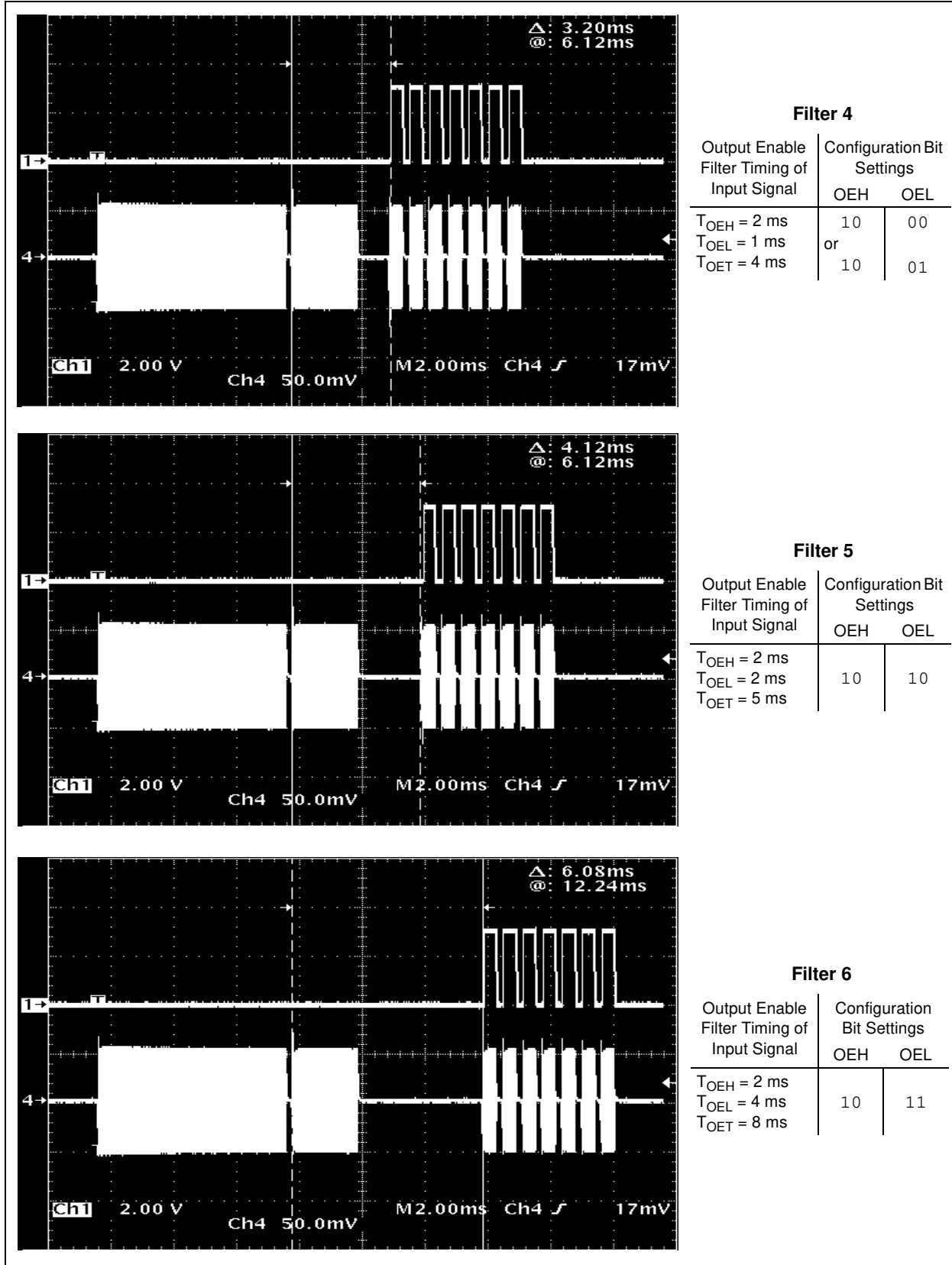

FIGURE 2-27: Examples of Output Enable Filters 4 through 6 (Wake-up Filters) and Demodulated Outputs.

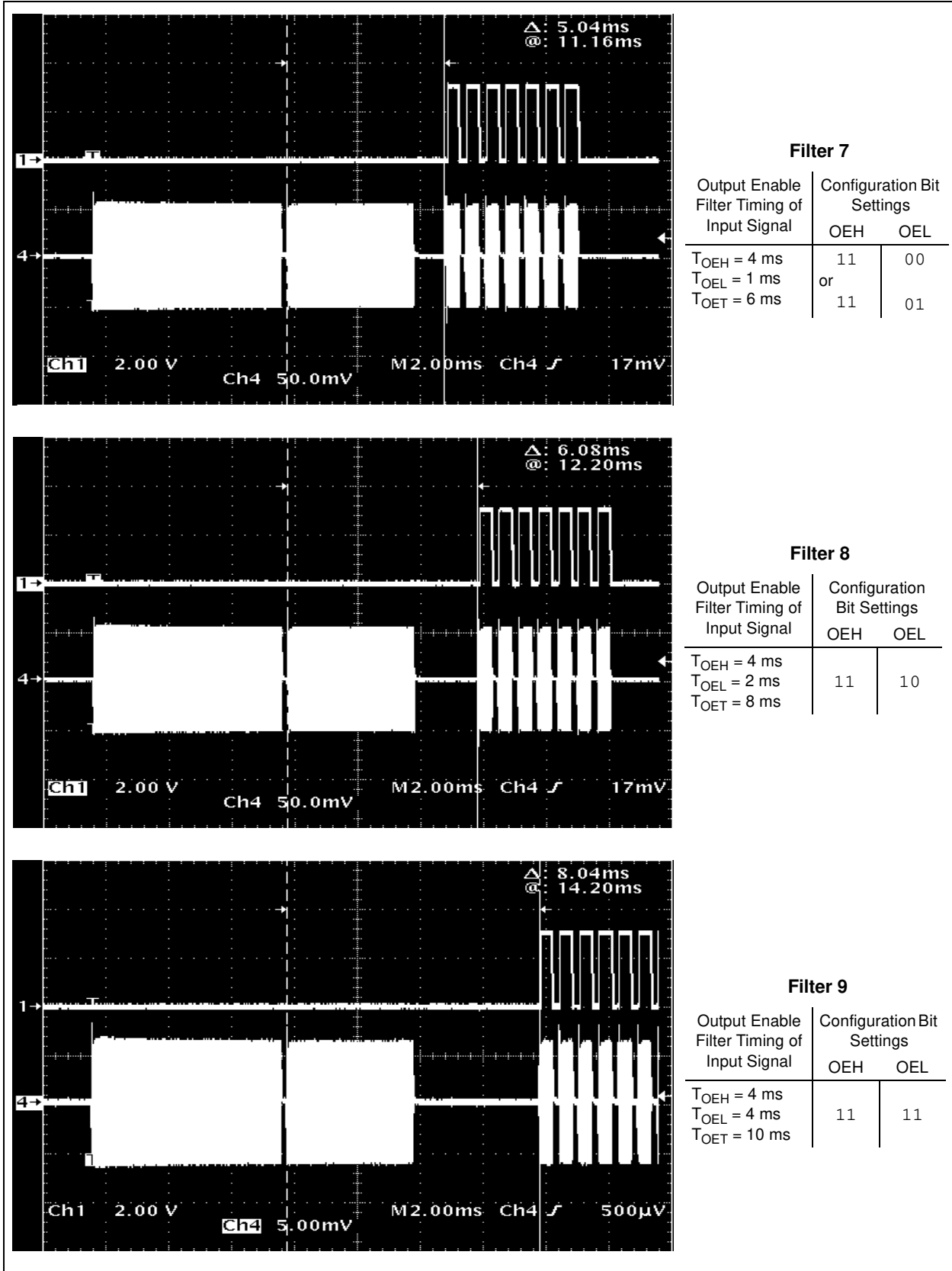

FIGURE 2-28: Examples of Output Enable Filters 7 through 9 (Wake-up Filters) and Demodulated Outputs.

MCP2030

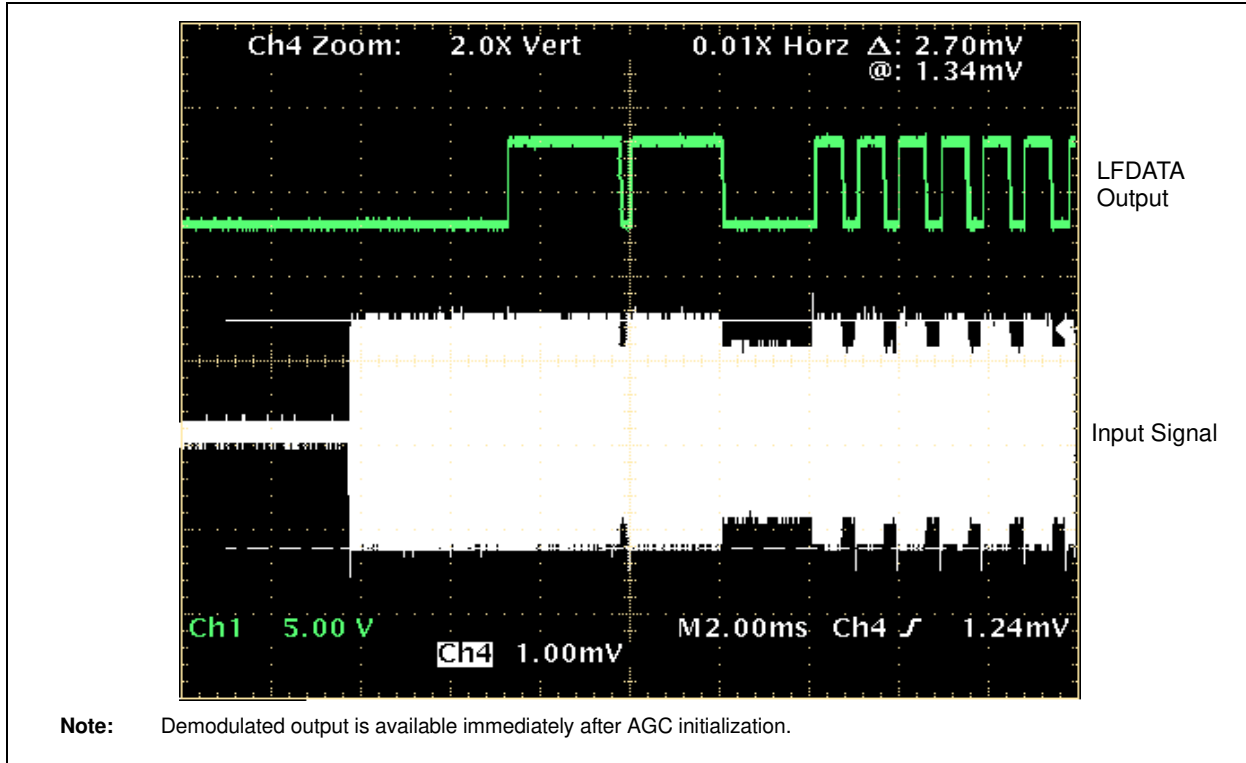

FIGURE 2-29: *Input Signal and Demodulated Output When the Output Enable Filter is Disabled.*

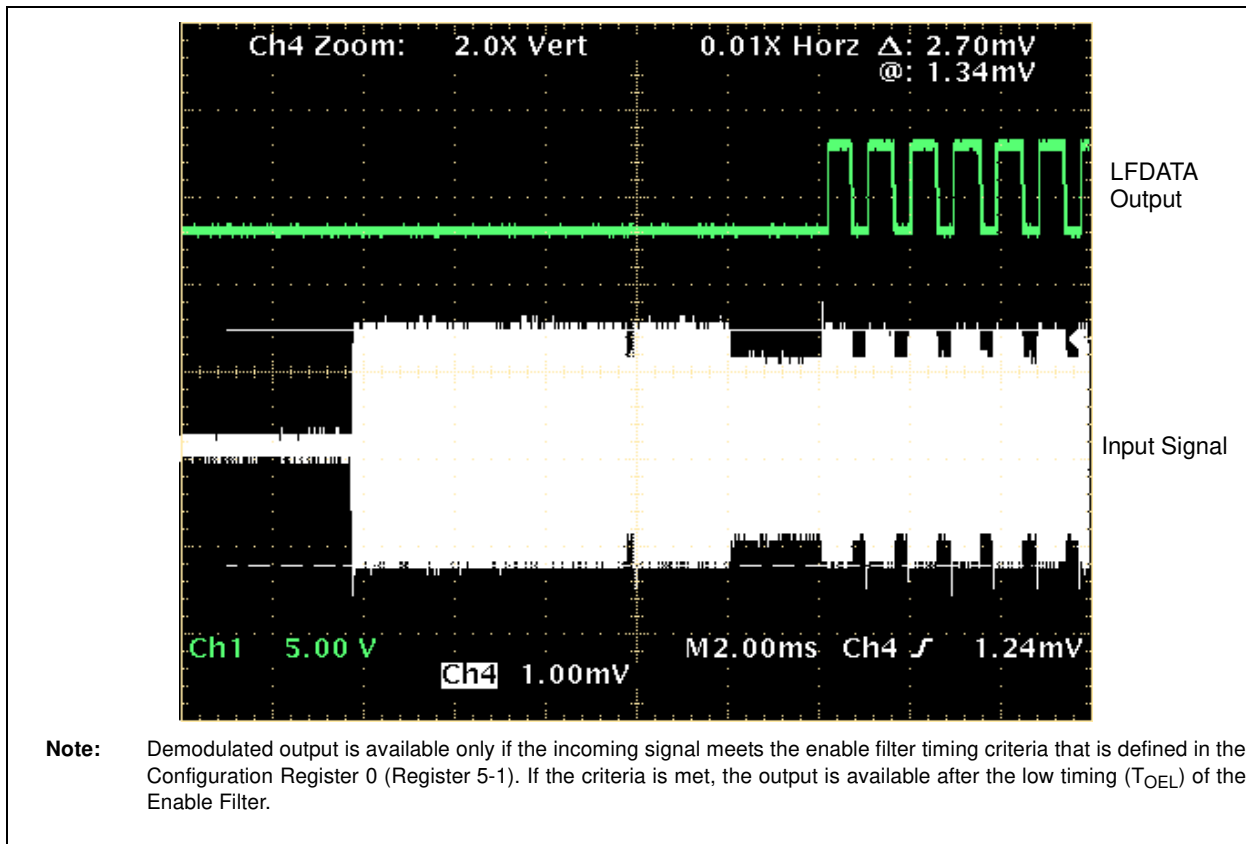

FIGURE 2-30: *Input Signal and Demodulator Output When Output Enable Filter is Enabled and Input Meets Filter Timing Requirements.*

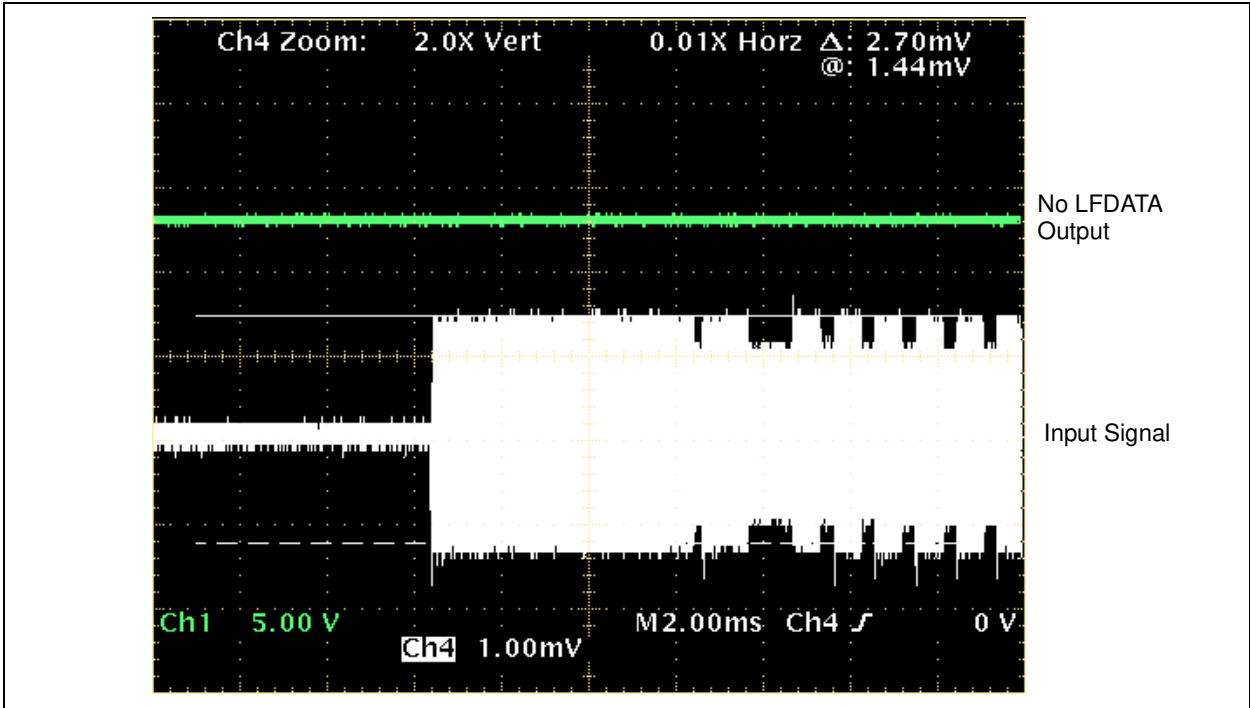

FIGURE 2-31: No Demodulator Output When Output Enable Filter is Enabled But Input Does Not Meet Filter Timing Requirements.

MCP2030

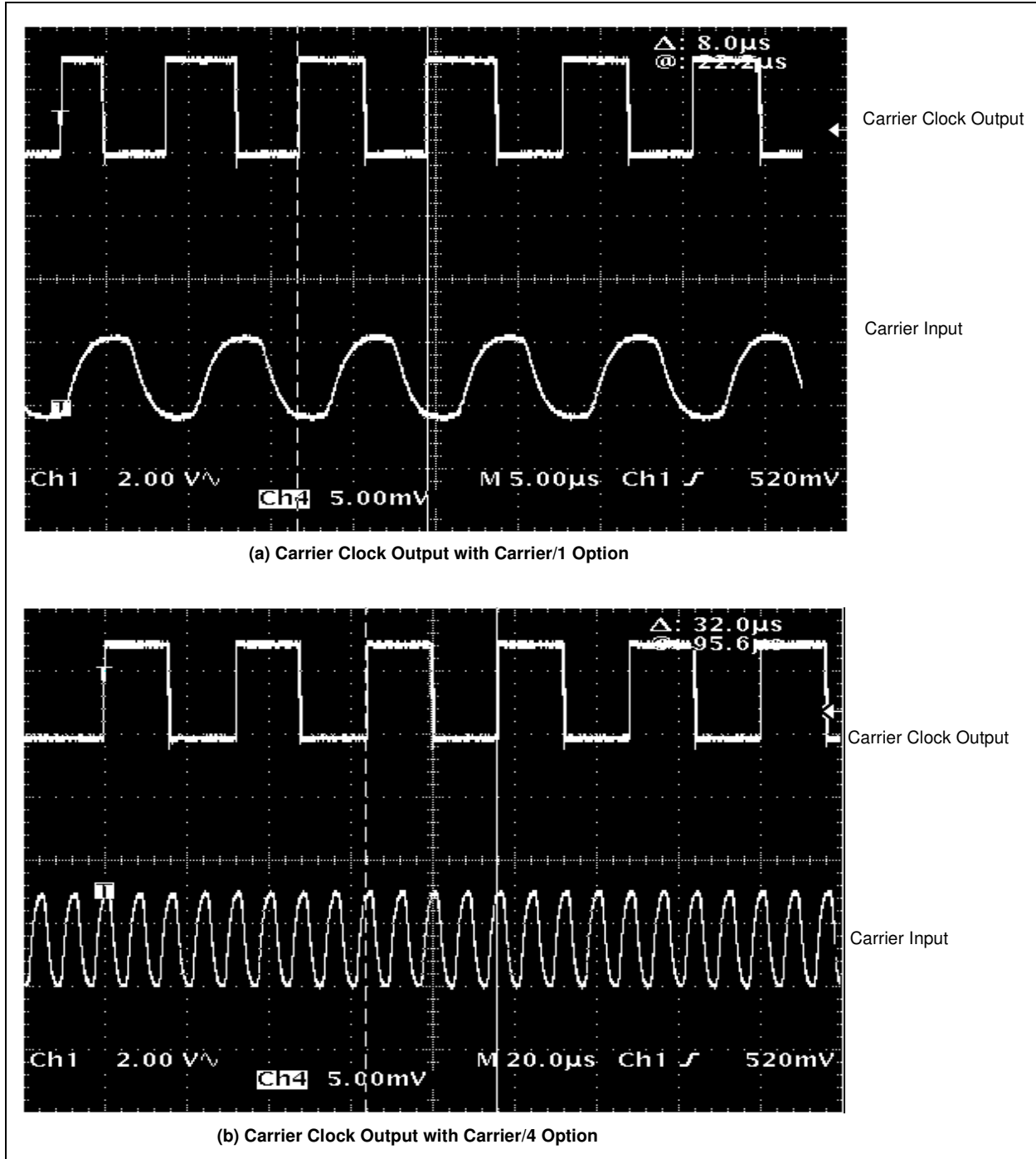

FIGURE 2-32: Carrier Clock Output Examples.

3.0 PIN DESCRIPTIONS

TABLE 3-1: PIN FUNCTION TABLES

| Pin No. | Symbol | I/O/P | Function |
|---------|-------------------------|-------|---|
| 1 | V_{SS} | P | Ground Pin. |
| 2 | \overline{CS} | I | Chip Select Digital Input Pin. |
| 3 | $SCLK/\overline{ALERT}$ | I/O | Clock input for the modified 3-wire SPI interface. ALERT output: This pin goes low if there is a parity error in the Configuration register or the 32 ms alarm timer is timed out. |
| 4 | RSSI | O | Received Signal Strength Indicator (RSSI) current output. |
| 5 | NC | N/A | No Connect. |
| 6 | LFDATA/CCLK/SDIO | I/O | Demodulated data output. Carrier clock output. Serial input or output data for the modified 3-wire SPI interface. |
| 7 | V_{DD} | P | Positive Supply Voltage Pin. |
| 8 | V_{DD} | P | Positive Supply Voltage Pin. |
| 9 | LCZ | I | Input pin for external LC antennas. |
| 10 | LCY | I | Input pin for external LC antennas. |
| 11 | LCX | I | Input pin for external LC antennas. |
| 12 | NC | N/A | No Connect. |
| 13 | LCCOM | I | Common reference input for the external LC antennas. |
| 14 | V_{SS} | P | Ground Pin. |

Type Identification: I = Input; O = Output; P = Power

3.1 Supply Voltage (V_{DD} , V_{SS})

The V_{DD} pin is the power supply pin for the analog and digital circuitry within the MCP2030. This pin requires an appropriate bypass capacitor of 0.1 μ F. The voltage on this pin should be maintained in the 2.0V-3.6V range for specified operation.

The V_{SS} pin is the ground pin and the current return path for both analog and digital circuitry of the MCP2030. If an analog ground plane is available, it is recommended that this device be tied to the analog ground plane of the PCB.

3.2 Chip Select (\overline{CS})

The \overline{CS} pin needs to stay high when the device is receiving input signals. Leaving the \overline{CS} pin low will place the device in the SPI Programming mode.

The \overline{CS} pin is an open collector output. This pin has an internal pull-up resistor to ensure that no spurious SPI communication occurs between power-up and pin configuration of the MCU.

3.3 SPI Clock Input ($SCLK/\overline{ALERT}$)

This pin becomes the SPI clock input (SCLK) when \overline{CS} is low, and becomes the ALERT output when \overline{CS} is high.

The \overline{ALERT} pin is an open collector output. This pin has an internal pull-up resistor to ensure that no spurious SPI communication occurs between power-up and pin configuration of the MCU.

3.4 Received Signal Strength Indicator (RSSI)

This pin becomes the Received Signal Strength Indicator (RSSI) output current sink when the RSSI output option is selected.