



Chipsmall Limited consists of a professional team with an average of over 10 year of expertise in the distribution of electronic components. Based in Hongkong, we have already established firm and mutual-benefit business relationships with customers from,Europe,America and south Asia,supplying obsolete and hard-to-find components to meet their specific needs.

With the principle of "Quality Parts,Customers Priority,Honest Operation,and Considerate Service",our business mainly focus on the distribution of electronic components. Line cards we deal with include Microchip,ALPS,ROHM,Xilinx,Pulse,ON,Everlight and Freescale. Main products comprise IC,Modules,Potentiometer,IC Socket,Relay,Connector.Our parts cover such applications as commercial,industrial, and automotives areas.

We are looking forward to setting up business relationship with you and hope to provide you with the best service and solution. Let us make a better world for our industry!



## Contact us

Tel: +86-755-8981 8866 Fax: +86-755-8427 6832

Email & Skype: info@chipsmall.com Web: www.chipsmall.com

Address: A1208, Overseas Decoration Building, #122 Zhenhua RD., Futian, Shenzhen, China



# MCR12DCM, MCR12DCN

Preferred Device

## Silicon Controlled Rectifiers

### Reverse Blocking Thyristors

Designed for high volume, low cost, industrial and consumer applications such as motor control; process control; temperature, light and speed control.

#### Features

- Small Size
- Passivated Die for Reliability and Uniformity
- Low Level Triggering and Holding Characteristics
- Epoxy Meets UL 94 V-0 @ 0.125 in
- ESD Ratings: Human Body Model, 3B > 8000 V  
Machine Model, C > 400 V
- Pb-Free Packages are Available

#### MAXIMUM RATINGS (T<sub>J</sub> = 25°C unless otherwise noted)

Rating	Symbol	Value	Unit
Peak Repetitive Off-State Voltage (Note 1) (T <sub>J</sub> = -40 to 125°C, Sine Wave, 50 to 60 Hz, Gate Open) MCR12DCM MCR12DCN	V <sub>DRM</sub> , V <sub>RRM</sub>	600 800	V
On-State RMS Current (180° Conduction Angles; T <sub>C</sub> = 90°C)	I <sub>T(RMS)</sub>	12	A
Average On-State Current (180° Conduction Angles; T <sub>C</sub> = 90°C)	I <sub>T(AV)</sub>	7.8	A
Peak Non-Repetitive Surge Current (1/2 Cycle, Sine Wave 60 Hz, T <sub>J</sub> = 125°C)	I <sub>TSM</sub>	100	A
Circuit Fusing Consideration (t = 8.3 msec)	I <sup>2</sup> t	41	A <sup>2</sup> sec
Forward Peak Gate Power (Pulse Width ≤ 1.0 μsec, T <sub>C</sub> = 90°C)	P <sub>GM</sub>	5.0	W
Forward Average Gate Power (t = 8.3 msec, T <sub>C</sub> = 90°C)	P <sub>G(AV)</sub>	0.5	W
Forward Peak Gate Current (Pulse Width ≤ 1.0 μsec, T <sub>C</sub> = 90°C)	I <sub>GM</sub>	2.0	A
Operating Junction Temperature Range	T <sub>J</sub>	-40 to 125	°C
Storage Temperature Range	T <sub>stg</sub>	-40 to 150	°C

Maximum ratings are those values beyond which device damage can occur. Maximum ratings applied to the device are individual stress limit values (not normal operating conditions) and are not valid simultaneously. If these limits are exceeded, device functional operation is not implied, damage may occur and reliability may be affected.

1. V<sub>DRM</sub> for all types can be applied on a continuous basis. Ratings apply for zero or negative gate voltage; positive gate voltage shall not be applied concurrent with negative potential on the anode. Blocking voltages shall not be tested with a constant current source such that the voltage ratings of the device are exceeded.



ON Semiconductor®

<http://onsemi.com>

SCRs  
12 AMPERES RMS  
600 – 800 VOLTS

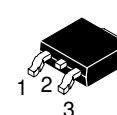

DPAK  
CASE 369C  
STYLE 4

#### MARKING DIAGRAM

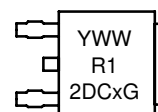

Y = Year  
WW = Work Week  
R12DCx = Device Code  
x = M or N  
G = Pb-Free Package

#### PIN ASSIGNMENT

Pin	Assignment
1	Cathode
2	Anode
3	Gate
4	Anode

#### ORDERING INFORMATION

See detailed ordering and shipping information in the package dimensions section on page 2 of this data sheet.

Preferred devices are recommended choices for future use and best overall value.

# MCR12DCM, MCR12DCN

## THERMAL CHARACTERISTICS

Characteristic	Symbol	Max	Unit
Thermal Resistance – Junction-to-Case	$R_{\theta JC}$	2.2	$^{\circ}C/W$
– Junction-to-Ambient	$R_{\theta JA}$	88	
– Junction-to-Ambient (Note 2)	$R_{\theta JA}$	80	
Maximum Lead Temperature for Soldering Purposes (Note 3)	$T_L$	260	$^{\circ}C$

## ELECTRICAL CHARACTERISTICS ( $T_J = 25^{\circ}C$ unless otherwise noted)

Characteristic	Symbol	Min	Typ	Max	Unit
----------------	--------	-----	-----	-----	------

### OFF CHARACTERISTICS

Peak Repetitive Forward or Reverse Blocking Current ( $V_{AK} = \text{Rated } V_{DRM} \text{ or } V_{RRM}$ , Gate Open)	$I_{DRM}$ , $I_{RRM}$	–	–	0.01	mA
$T_J = 25^{\circ}C$					
$T_J = 125^{\circ}C$		–	–	5.0	

### ON CHARACTERISTICS

Peak Forward On-State Voltage (Note 4) ( $I_{TM} = 20 \text{ A}$ )	$V_{TM}$	–	1.3	1.9	V
Gate Trigger Current (Continuous dc) ( $V_D = 12 \text{ V}$ , $R_L = 100 \Omega$ )	$I_{GT}$	2.0	7.0	20	mA
$T_J = 25^{\circ}C$					
$T_J = -40^{\circ}C$		–	–	40	
Gate Trigger Voltage (Continuous dc) ( $V_D = 12 \text{ V}$ , $R_L = 100 \Omega$ )	$V_{GT}$	0.5	0.65	1.0	V
$T_J = 25^{\circ}C$					
$T_J = -40^{\circ}C$		–	–	2.0	
Gate Non-Trigger Voltage ( $V_D = 12 \text{ V}$ , $R_L = 100 \Omega$ )	$V_{GD}$	0.2	–	–	V
Holding Current ( $V_D = 12 \text{ V}$ , Initiating Current = 200 mA, Gate Open)	$I_H$	4.0	22	40	mA
$T_J = 25^{\circ}C$					
$T_J = -40^{\circ}C$		–	–	80	
Latching Current ( $V_D = 12 \text{ V}$ , $I_G = 20 \text{ mA}$ , $T_J = 25^{\circ}C$ ) ( $V_D = 12 \text{ V}$ , $I_G = 40 \text{ mA}$ , $T_J = -40^{\circ}C$ )	$I_L$	4.0	22	40	mA
$T_J = 25^{\circ}C$					
$T_J = -40^{\circ}C$		–	–	80	

### DYNAMIC CHARACTERISTICS

Critical Rate of Rise of Off-State Voltage ( $V_D = \text{Rated } V_{DRM}$ , Exponential Waveform, Gate Open, $T_J = 125^{\circ}C$ )	dv/dt	50	200	–	V/ $\mu s$
-----------------------------------------------------------------------------------------------------------------------------------------	-------	----	-----	---	------------

- These ratings are applicable when surface mounted on the minimum pad sizes recommended.
- 1/8" from case for 10 seconds.
- Pulse Test: Pulse Width  $\leq 2.0$  msec, Duty Cycle  $\leq 2\%$ .

## ORDERING INFORMATION

Device	Package	Shipping†
MCR12DCMT4	DDPAK	2500 / Tape and Reel
MCR12DCMT4G	DDPAK (Pb-Free)	2500 / Tape and Reel
MCR12DCNT4	DDPAK	2500 / Tape and Reel
MCR12DCNT4G	DDPAK (Pb-Free)	2500 / Tape and Reel

†For information on tape and reel specifications, including part orientation and tape sizes, please refer to our Tape and Reel Packaging Specifications Brochure, BRD8011/D.

# MCR12DCM, MCR12DCN

## Voltage Current Characteristic of SCR

Symbol	Parameter
$V_{DRM}$	Peak Repetitive Off-State Forward Voltage
$I_{DRM}$	Peak Forward Blocking Current
$V_{RRM}$	Peak Repetitive Off-State Reverse Voltage
$I_{RRM}$	Peak Reverse Blocking Current
$V_{TM}$	Peak On-State Voltage
$I_H$	Holding Current

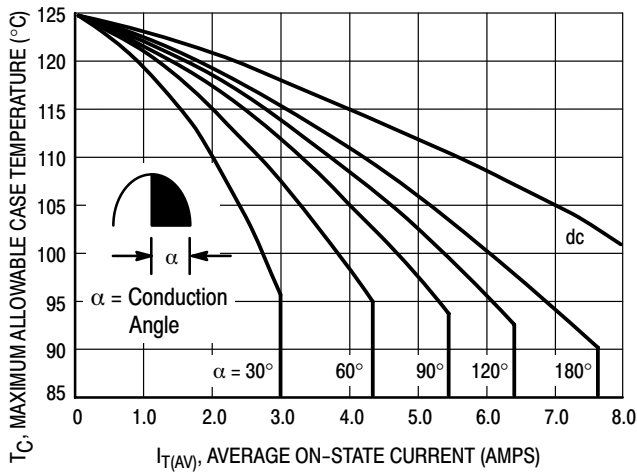
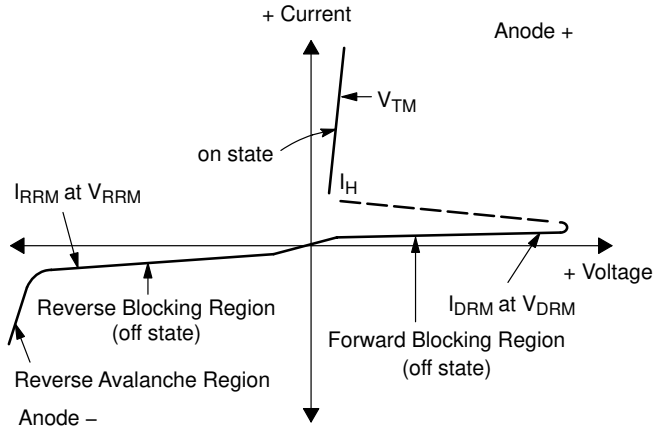

Figure 1. Average Current Derating

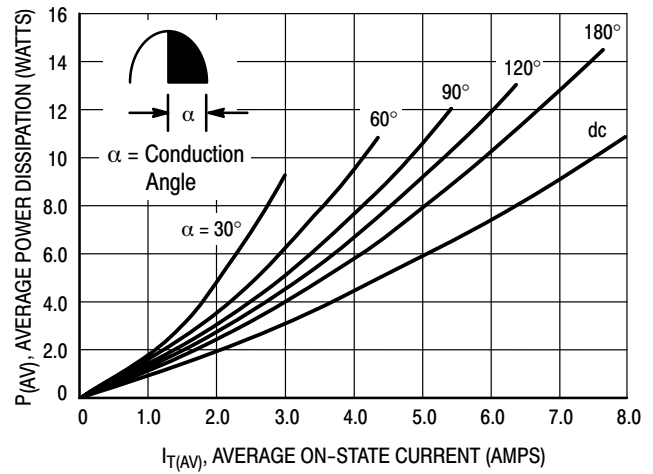

Figure 2. On-State Power Dissipation

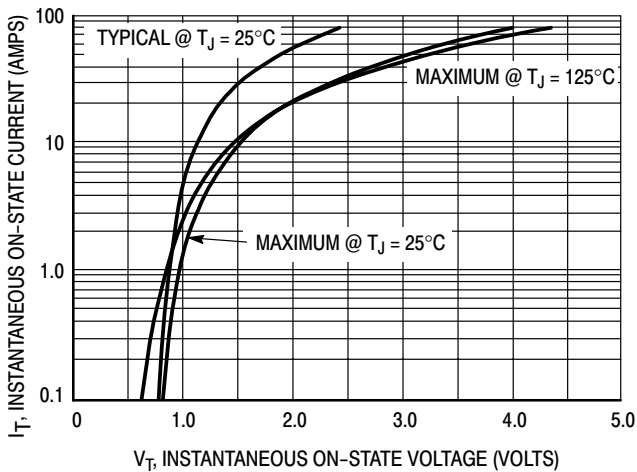

Figure 3. On-State Characteristics

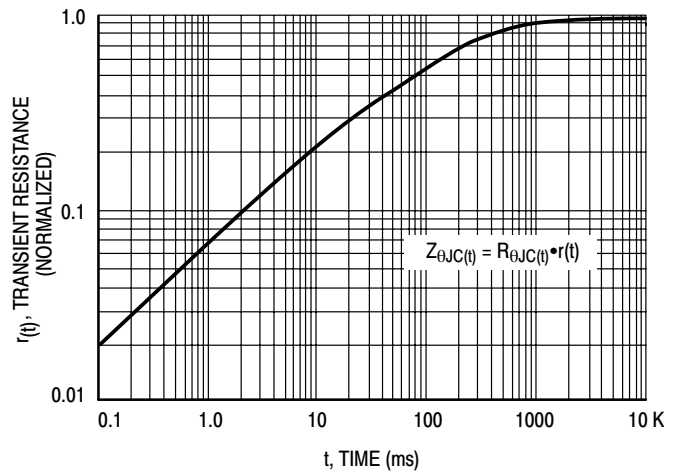

Figure 4. Transient Thermal Response

# MCR12DCM, MCR12DCN

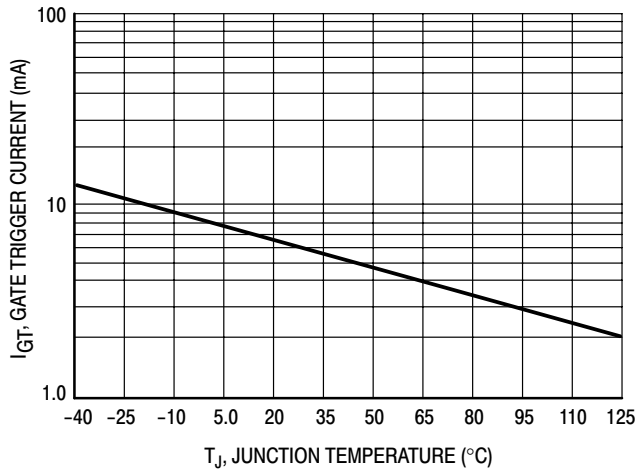

Figure 5. Typical Gate Trigger Current versus Junction Temperature

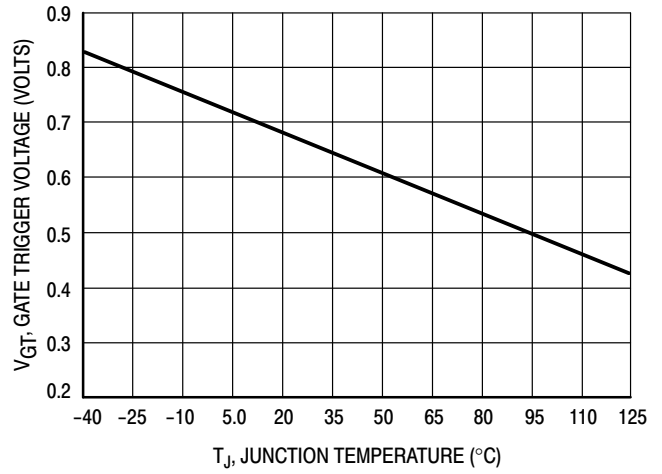

Figure 6. Typical Gate Trigger Voltage versus Junction Temperature

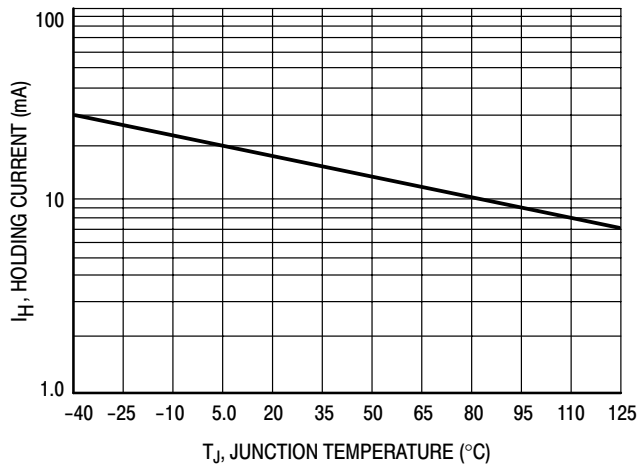

Figure 7. Typical Holding Current versus Junction Temperature

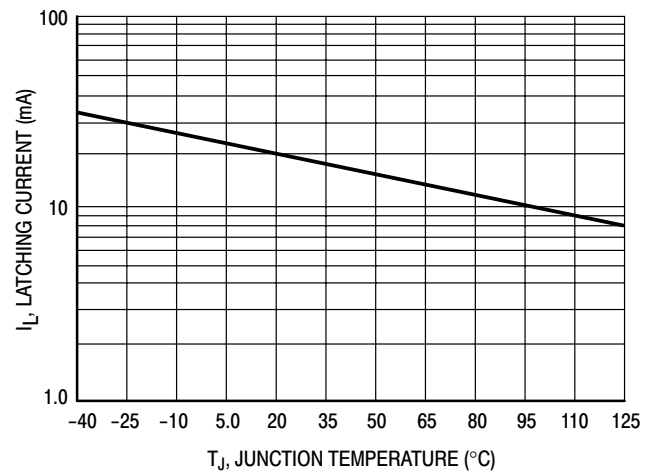

Figure 8. Typical Latching Current versus Junction Temperature

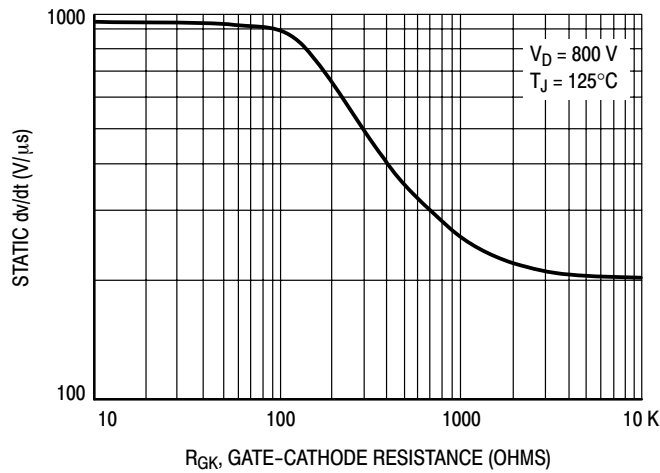
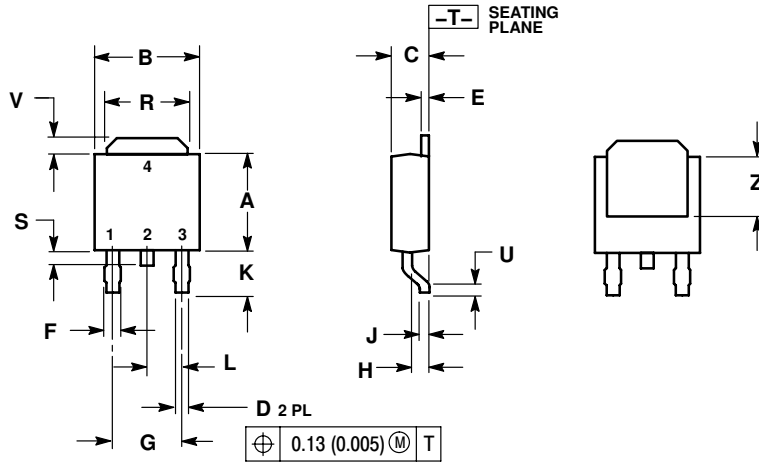

Figure 9. Exponential Static dv/dt versus Gate-Cathode Resistance

# MCR12DCM, MCR12DCN

## PACKAGE DIMENSIONS

### DPAK CASE 369C ISSUE O



- NOTES:  
 1. DIMENSIONING AND TOLERANCING PER ANSI Y14.5M, 1982.  
 2. CONTROLLING DIMENSION: INCH.

DIM	INCHES		MILLIMETERS	
	MIN	MAX	MIN	MAX
A	0.235	0.245	5.97	6.22
B	0.250	0.265	6.35	6.73
C	0.086	0.094	2.19	2.38
D	0.027	0.035	0.69	0.88
E	0.018	0.023	0.46	0.58
F	0.037	0.045	0.94	1.14
G	0.180 BSC		4.58 BSC	
H	0.034	0.040	0.87	1.01
J	0.018	0.023	0.46	0.58
K	0.102	0.114	2.60	2.89
L	0.090 BSC		2.29 BSC	
R	0.180	0.215	4.57	5.45
S	0.025	0.040	0.63	1.01
U	0.020	---	0.51	---
V	0.035	0.050	0.89	1.27
Z	0.155	---	3.93	---

- STYLE 4:  
 PIN 1. CATHODE  
 2. ANODE  
 3. GATE  
 4. ANODE

### SOLDERING FOOTPRINT\*

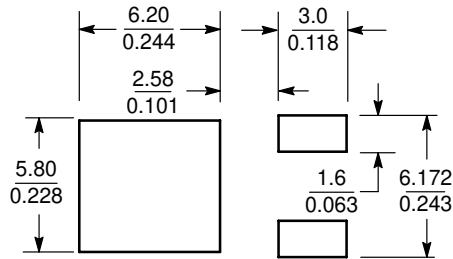

SCALE 3:1 (mm/inches)

\*For additional information on our Pb-Free strategy and soldering details, please download the ON Semiconductor Soldering and Mounting Techniques Reference Manual, SOLDERRM/D.

ON Semiconductor and are registered trademarks of Semiconductor Components Industries, LLC (SCILLC). SCILLC reserves the right to make changes without further notice to any products herein. SCILLC makes no warranty, representation or guarantee regarding the suitability of its products for any particular purpose, nor does SCILLC assume any liability arising out of the application or use of any product or circuit, and specifically disclaims any and all liability, including without limitation special, consequential or incidental damages. "Typical" parameters which may be provided in SCILLC data sheets and/or specifications can and do vary in different applications and actual performance may vary over time. All operating parameters, including "Typicals" must be validated for each customer application by customer's technical experts. SCILLC does not convey any license under its patent rights nor the rights of others. SCILLC products are not designed, intended, or authorized for use as components in systems intended for surgical implant into the body, or other applications intended to support or sustain life, or for any other application in which the failure of the SCILLC product could create a situation where personal injury or death may occur. Should Buyer purchase or use SCILLC products for any such unintended or unauthorized application, Buyer shall indemnify and hold SCILLC and its officers, employees, subsidiaries, affiliates, and distributors harmless against all claims, costs, damages, and expenses, and reasonable attorney fees arising out of, directly or indirectly, any claim of personal injury or death associated with such unintended or unauthorized use, even if such claim alleges that SCILLC was negligent regarding the design or manufacture of the part. SCILLC is an Equal Opportunity/Affirmative Action Employer. This literature is subject to all applicable copyright laws and is not for resale in any manner.

### PUBLICATION ORDERING INFORMATION

**LITERATURE FULFILLMENT:**  
 Literature Distribution Center for ON Semiconductor  
 P.O. Box 61312, Phoenix, Arizona 85082-1312 USA  
**Phone:** 480-829-7710 or 800-344-3860 Toll Free USA/Canada  
**Fax:** 480-829-7709 or 800-344-3867 Toll Free USA/Canada  
**Email:** orderlit@onsemi.com

**N. American Technical Support:** 800-282-9855 Toll Free  
 USA/Canada

**Japan:** ON Semiconductor, Japan Customer Focus Center  
 2-9-1 Kamimeguro, Meguro-ku, Tokyo, Japan 153-0051  
**Phone:** 81-3-5773-3850

**ON Semiconductor Website:** <http://onsemi.com>

**Order Literature:** <http://www.onsemi.com/litorder>

For additional information, please contact your local Sales Representative.