



Chipsmall Limited consists of a professional team with an average of over 10 year of expertise in the distribution of electronic components. Based in Hongkong, we have already established firm and mutual-benefit business relationships with customers from,Europe,America and south Asia,supplying obsolete and hard-to-find components to meet their specific needs.

With the principle of “Quality Parts,Customers Priority,Honest Operation,and Considerate Service”,our business mainly focus on the distribution of electronic components. Line cards we deal with include Microchip,ALPS,ROHM,Xilinx,Pulse,ON,Everlight and Freescale. Main products comprise IC,Modules,Potentiometer,IC Socket,Relay,Connector.Our parts cover such applications as commercial,industrial, and automotives areas.

We are looking forward to setting up business relationship with you and hope to provide you with the best service and solution. Let us make a better world for our industry!



Contact us

Tel: +86-755-8981 8866 Fax: +86-755-8427 6832

Email & Skype: info@chipsmall.com Web: www.chipsmall.com

Address: A1208, Overseas Decoration Building, #122 Zhenhua RD., Futian, Shenzhen, China

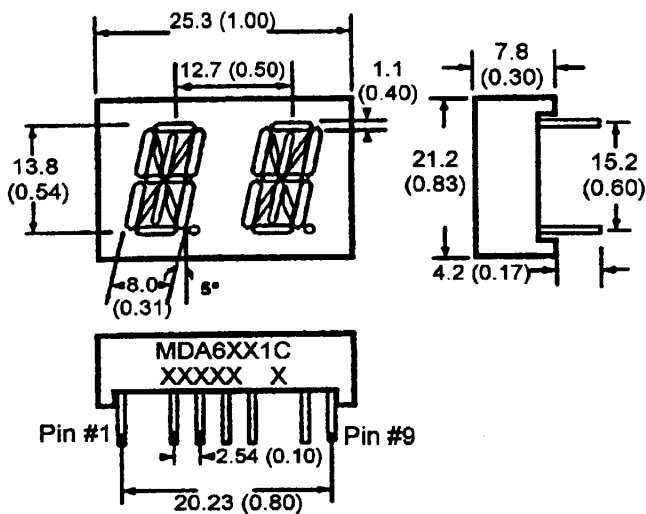

BRIGHT RED	MDA6141C
YELLOW	MDA6341C
GREEN	MDA6441C
HIGH EFF. RED	MDA6941C

PACKAGE DIMENSIONS

NOTES: Dimensions are in mm (inch).
All pins are 0.5 (0.02) diameter
Tolerances are ± 0.25 (0.1) unless otherwise noted.

FEATURES

Easy to read digits.
2 digit common cathode.
Multiplexing pin out
Low power consumption.
Bold segments that are highly visible.
High brightness with high contrast
White segments on a grey face.
Directly compatible with integrated circuits.
Rugged plastic/epoxy construction.

APPLICATIONS

Digital readout displays.
Instrument panels.

MODEL NUMBERS

<u>Part number</u>	<u>Color</u>	<u>Description</u>
MDA6141C	Bright Red	2 Digit; Common Cathode; Rt.Hand Decimal
MDA6341C	Yellow	2 Digit; Common Cathode; Rt.Hand Decimal
MDA6441C	Green	2 Digit; Common Cathode; Rt Hand Decimal
MDA6941C	High Eff. Red	2 Digit; Common Cathode; Rt Hand Decimal

(For other color options, contact your local area Sales Office)

ABSOLUTE MAXIMUM RATING (T_A=25°C unless otherwise specified)

Part number	B.Red MDA 6141C	Yellow MDA 6341C	Green MDA 6441C	High Eff. Red MDA 6941C	Unit
Continuous forward current (I _F)					
Per Segment.....	15	20	30	30	mA
Peak forward current per die (I _F). (at f = 1.0 KHz, Duty factor = 1/10)	50	80	90	160	mA
Power dissipation (P _D).....	40*	70*	70*	90*	mW
*Derate Linearly From 25°C.....	0.17	0.25	0.33	0.33	mW/°C
Reverse voltage per dice.....					5V
Operating and Storage temperature range.....					- 40°C to +85°C
Lead soldering time (at 1/16 inch from the bottom of lamp).....					5 seconds @ 230°C

ELECTRO - OPTICAL CHARACTERISTICS (T_A = 25°C unless otherwise specified)

Part number	B. Red MDA 6141C	Yellow MDA 6341C	Green MDA 6441C	High Eff. Red MDA 6941C	Test Condition
Luminous intensity (ucd)					
minimum	500	1000	750	1000	I _F = 20 mA
typical	1400	4000	5000	4000	I _F = 20 mA
Forward voltage (V _F)					
typical	2.1	2.1	2.1	2.0	I _F = 20 mA
maximum	2.6	2.8	2.8	2.8	I _F = 20 mA
Peak wavelength (nm)	697	590	570	635	I _F = 20 mA
Spectral line half width (nm)	90	30	30	35	I _F = 20 mA
Reverse breakdown voltage (V _R)	5	5	5	5	I _R = 100 uA

PINOUT

MDA6X41C - Common Cathode

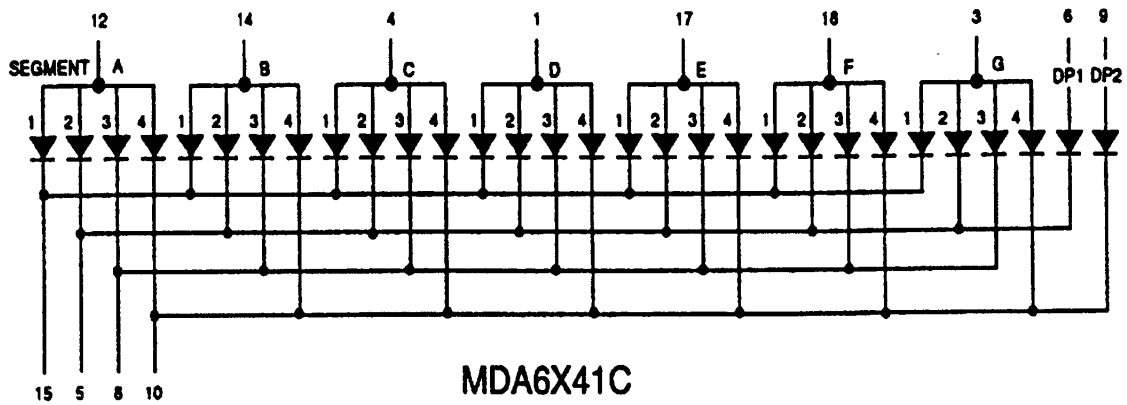
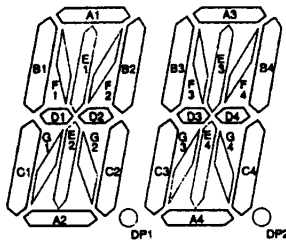

GRAPHICAL DETAIL: Bright Red

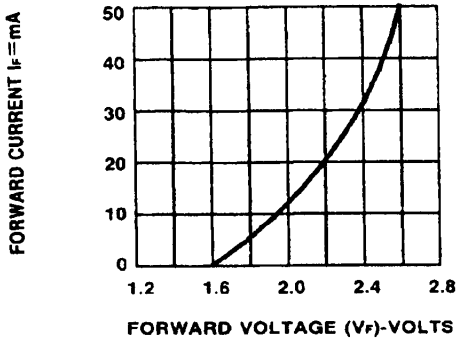

Fig.1 FORWARD CURRENT VS. FORWARD VOLTAGE.

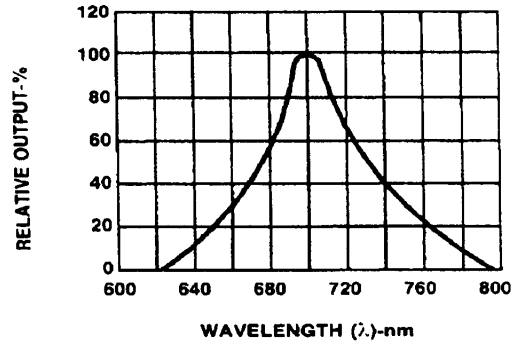

Fig.2 SPECTRAL RESPONSE

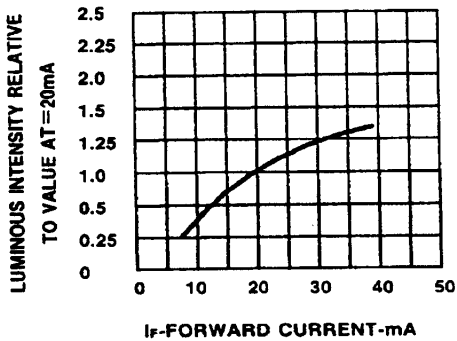

Fig.3 RELATIVE LUMINOUS INTENSITY VS. FORWARD CURRENT

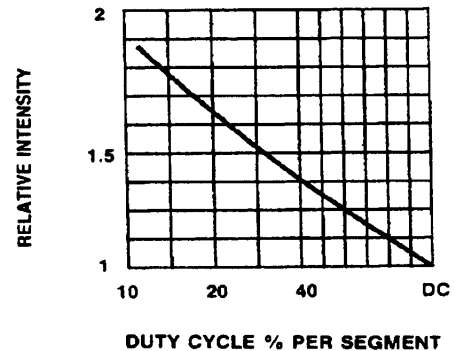

Fig.5 LUMINOUS INTENSITY VS. DUTY CYCLE

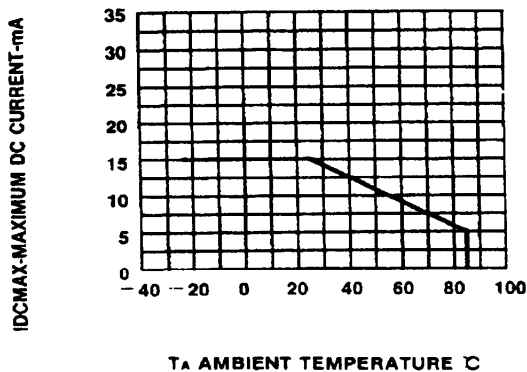

Fig.4 MAXIMUM ALLOWABLE DC CURRENT PER SEGMENT VS. A FUNCTION OF AMBIENT TEMPERATURE.

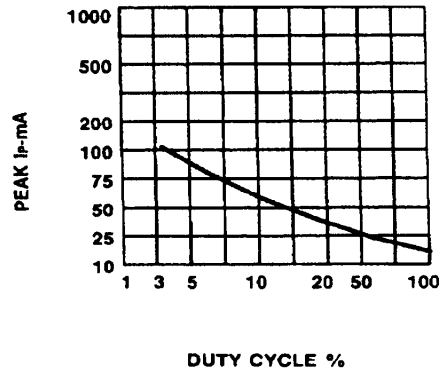

Fig. 6 MAX PEAK CURRENT VS. DUTY CYCLE % (REFRESH RATE f=1 KHz)

GRAPHICAL DETAIL: Green

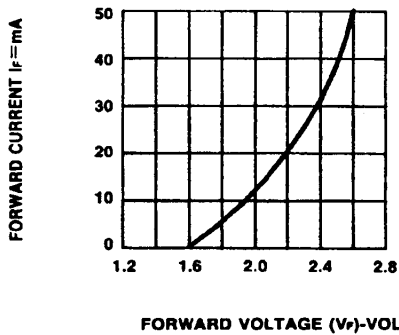

Fig.1 FORWARD CURRENT VS. FORWARD VOLTAGE.

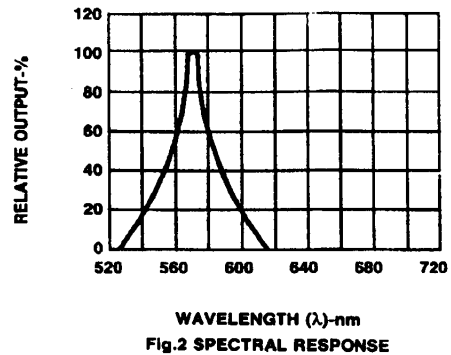

Fig.2 SPECTRAL RESPONSE

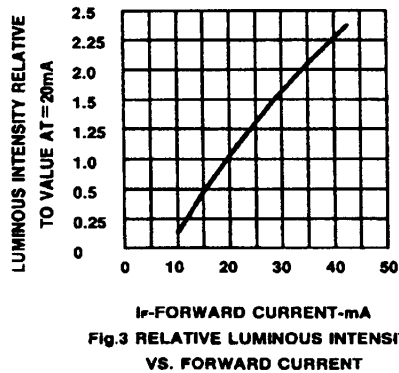

Fig.3 RELATIVE LUMINOUS INTENSITY VS. FORWARD CURRENT

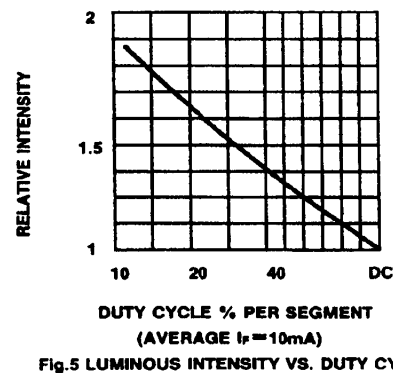

Fig.5 LUMINOUS INTENSITY VS. DUTY CYCLE

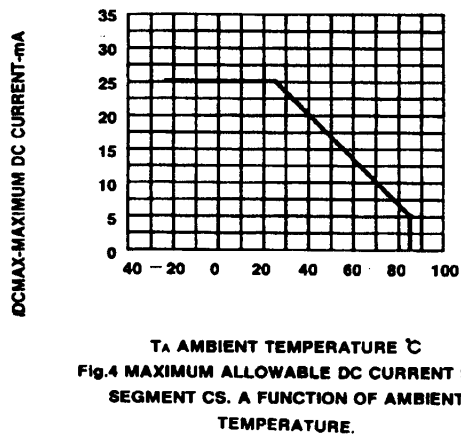

Fig.4 MAXIMUM ALLOWABLE DC CURRENT PER SEGMENT CS. A FUNCTION OF AMBIENT TEMPERATURE.

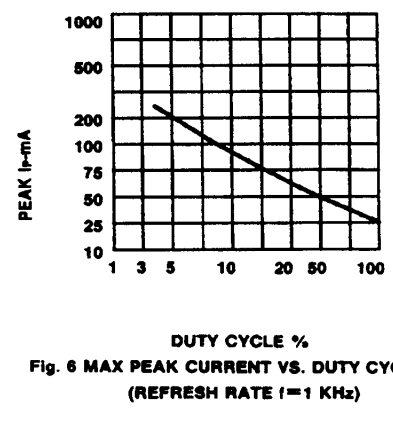

Fig. 6 MAX PEAK CURRENT VS. DUTY CYCLE % (REFRESH RATE f=1 KHz)

GRAPHICAL DETAIL: High Efficiency Red

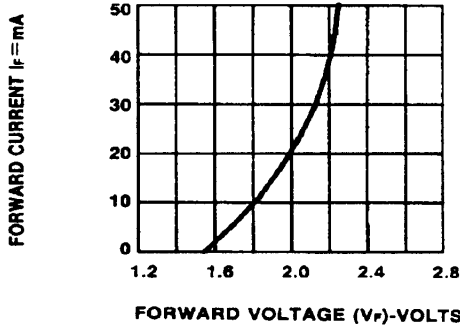

Fig.1 FORWARD CURRENT VS. FORWARD VOLTAGE.

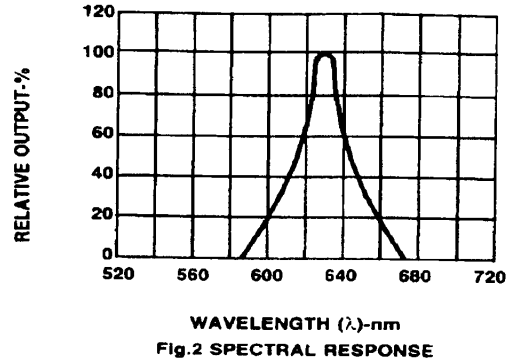

Fig.2 SPECTRAL RESPONSE

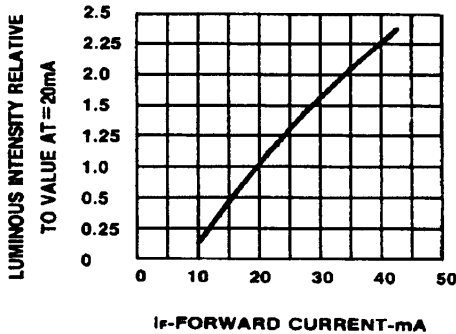

Fig.3 RELATIVE LUMINOUS INTENSITY VS. FORWARD CURRENT

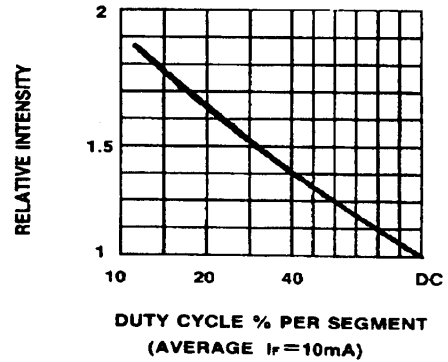

Fig.5 LUMINOUS INTENSITY VS. DUTY CYCLE

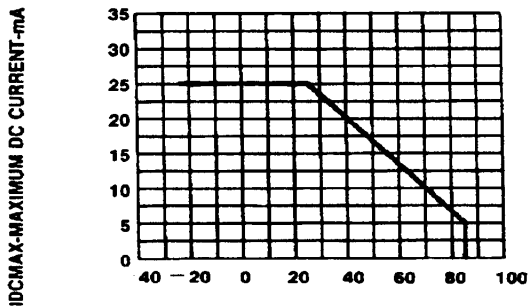

Fig.4 MAXIMUM ALLOWABLE DC CURRENT PER SEGMENT VS. A FUNCTION OF AMBIENT TEMPERATURE.

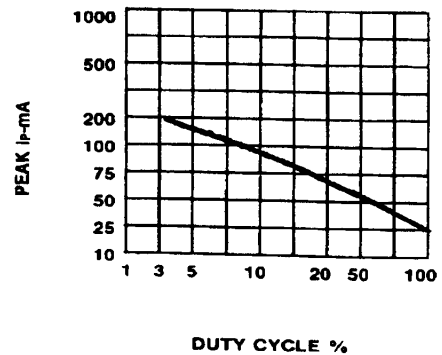

Fig. 6 MAX PEAK CURRENT VS. DUTY CYCLE % (REFRESH RATE (=1 KHz))

GRAPHICAL DETAIL: Yellow

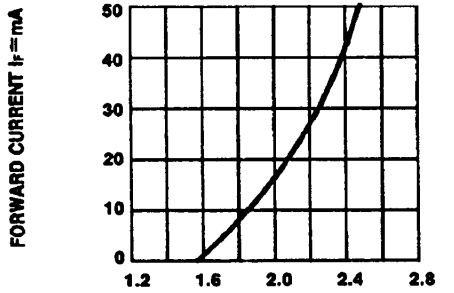

Fig.1 FORWARD CURRENT VS. FORWARD VOLTAGE.

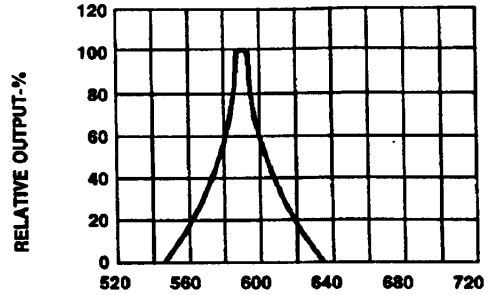

Fig.2 SPECTRAL RESPONSE

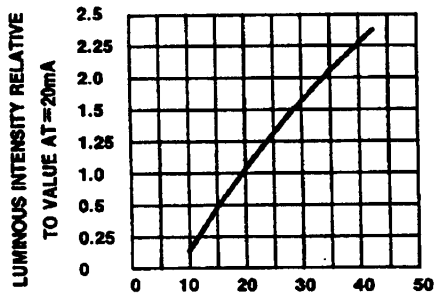

Fig.3 RELATIVE LUMINOUS INTENSITY VS. FORWARD CURRENT

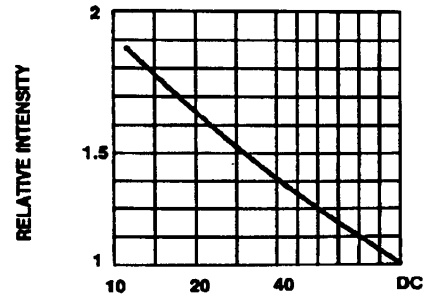

Fig.5 LUMINOUS INTENSITY VS. DUTY CYCLE

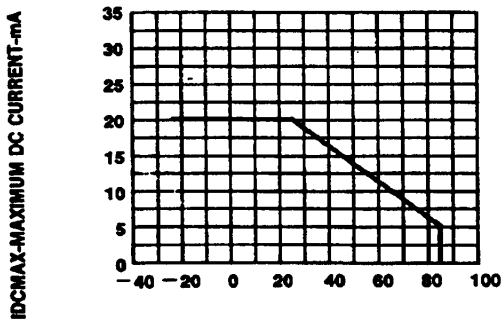

Fig.4 MAXIMUM ALLOWABLE DC CURRENT PER SEGMENT VS. A FUNCTION OF AMBIENT TEMPERATURE.

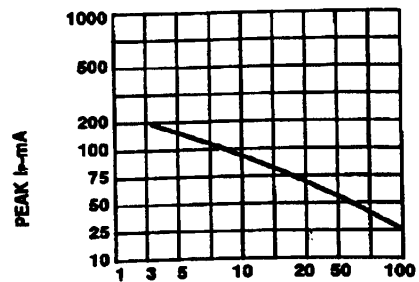

Fig. 6 MAX PEAK CURRENT VS. DUTY CYCLE % (REFRESH RATE $f = 1$ KHz)

DISCLAIMER

FAIRCHILD SEMICONDUCTOR RESERVES THE RIGHT TO MAKE CHANGES WITHOUT FURTHER NOTICE TO ANY PRODUCTS HEREIN TO IMPROVE RELIABILITY, FUNCTION OR DESIGN. FAIRCHILD DOES NOT ASSUME ANY LIABILITY ARISING OUT OF THE APPLICATION OR USE OF ANY PRODUCT OR CIRCUIT DESCRIBED HEREIN; NEITHER DOES IT CONVEY ANY LICENSE UNDER ITS PATENT RIGHTS, NOR THE RIGHTS OF OTHERS.

LIFE SUPPORT POLICY

FAIRCHILD'S PRODUCTS ARE NOT AUTHORIZED FOR USE AS CRITICAL COMPONENTS IN LIFE SUPPORT DEVICES OR SYSTEMS WITHOUT THE EXPRESS WRITTEN APPROVAL OF THE PRESIDENT OF FAIRCHILD SEMICONDUCTOR CORPORATION. As used herein:

1. Life support devices or systems are devices or systems which, (a) are intended for surgical implant into the body, or (b) support or sustain life, and (c) whose failure to perform when properly used in accordance with instructions for use provided in the labeling, can be reasonably expected to result in a significant injury of the user.
2. A critical component in any component of a life support device or system whose failure to perform can be reasonably expected to cause the failure of the life support device or system, or to affect its safety or effectiveness.