



Chipsmall Limited consists of a professional team with an average of over 10 year of expertise in the distribution of electronic components. Based in Hongkong, we have already established firm and mutual-benefit business relationships with customers from,Europe,America and south Asia,supplying obsolete and hard-to-find components to meet their specific needs.

With the principle of “Quality Parts,Customers Priority,Honest Operation,and Considerate Service”,our business mainly focus on the distribution of electronic components. Line cards we deal with include Microchip,ALPS,ROHM,Xilinx,Pulse,ON,Everlight and Freescale. Main products comprise IC,Modules,Potentiometer,IC Socket,Relay,Connector.Our parts cover such applications as commercial,industrial, and automotives areas.

We are looking forward to setting up business relationship with you and hope to provide you with the best service and solution. Let us make a better world for our industry!



Contact us

Tel: +86-755-8981 8866 Fax: +86-755-8427 6832

Email & Skype: info@chipsmall.com Web: www.chipsmall.com

Address: A1208, Overseas Decoration Building, #122 Zhenhua RD., Futian, Shenzhen, China





**MS Long-Range
Handheld Transmitter
Master Development System
User's Guide**

Wireless made simple[®]

Warning: Some customers may want Linx radio frequency (“RF”) products to control machinery or devices remotely, including machinery or devices that can cause death, bodily injuries, and/or property damage if improperly or inadvertently triggered, particularly in industrial settings or other applications implicating life-safety concerns (“Life and Property Safety Situations”).

NO OEM LINX REMOTE CONTROL OR FUNCTION MODULE SHOULD EVER BE USED IN LIFE AND PROPERTY SAFETY SITUATIONS. No OEM Linx Remote Control or Function Module should be modified for Life and Property Safety Situations. Such modification cannot provide sufficient safety and will void the product’s regulatory certification and warranty.

Customers may use our (non-Function) Modules, Antenna and Connectors as part of other systems in Life Safety Situations, but only with necessary and industry appropriate redundancies and in compliance with applicable safety standards, including without limitation, ANSI and NFPA standards. It is solely the responsibility of any Linx customer who uses one or more of these products to incorporate appropriate redundancies and safety standards for the Life and Property Safety Situation application.

Do not use this or any Linx product to trigger an action directly from the data line or RSSI lines without a protocol or encoder/decoder to validate the data. Without validation, any signal from another unrelated transmitter in the environment received by the module could inadvertently trigger the action.

All RF products are susceptible to RF interference that can prevent communication. RF products without frequency agility or hopping implemented are more subject to interference. This module does have a frequency hopping protocol built in, but the developer should still be aware of the risk of interference.

Do not use any Linx product over the limits in this data guide. Excessive voltage or extended operation at the maximum voltage could cause product failure. Exceeding the reflow temperature profile could cause product failure which is not immediately evident.

Do not make any physical or electrical modifications to any Linx product. This will void the warranty and regulatory and UL certifications and may cause product failure which is not immediately evident.

Table of Contents

- 1 [Introduction](#)
- 2 [Ordering Information](#)
- 2 [MS Series Decoder Development Board](#)
- 3 [Using the Master Development System](#)
- 3 [Troubleshooting](#)
- 4 [Setting the Transmitter Address](#)
- 4 [OTX-***-HH-LR8-MS Button Assignments](#)
- 5 [Contention Considerations](#)
- 5 [Battery Replacement](#)
- 5 [Assembly Diagram](#)
- 6 [The Decoder Board](#)
- 11 [Installing the Software and Drivers](#)
- 12 [Master Development Software](#)
- 15 [Resources](#)

MS Long-Range Handheld Transmitter Master Development System



Data Guide

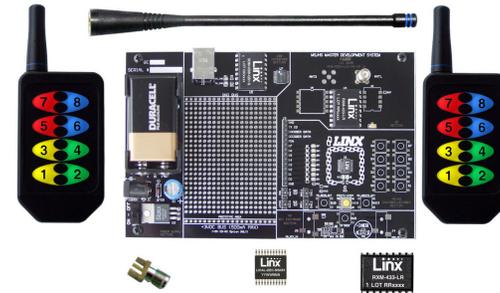

Figure 1: MS Long-Range Handheld Transmitter Master Development System

Introduction

The Linx MS Long-Range Handheld transmitter offers a simple, efficient and cost-effective method of adding remote control capabilities to any product. This Master Development System gives a designer all the tools necessary to incorporate the transmitter, LR Series receiver and MS Series decoder into a product. The Master Development System serves several important functions:

- **Rapid Evaluation:** It allows the performance and features of the transmitter, LR Series receiver and MS Series encoders and decoders to be evaluated quickly in a user's environment.
- **Range Testing:** The transmitter and receiver board form a full remote control system so that the range performance can be evaluated.
- **Design Benchmark:** The boards provide a known benchmark against which the performance of a custom design may be judged.
- **Application Development:** An onboard prototyping area allows for the development of custom circuits directly on the development board. All signal lines are available on a header for easy access.

The Master Development System includes 2 MS Long-Range Handheld transmitters, 2 LR Series receivers*, 2 MS Series decoders*, 1 receiver / decoder development board, 1 CW Series antenna, demonstration software CD and full documentation.

*One part is soldered to the board, one extra is for use on your first prototype board

Ordering Information

Ordering Information	
Part Number	Description
MDEV-***-HH-LR8-MS	MS Long-Range Transmitter Master Development System
*** = 315, 418 (Standard) or 433.92MHz	

Figure 2: Ordering Information

MS Series Decoder Development Board

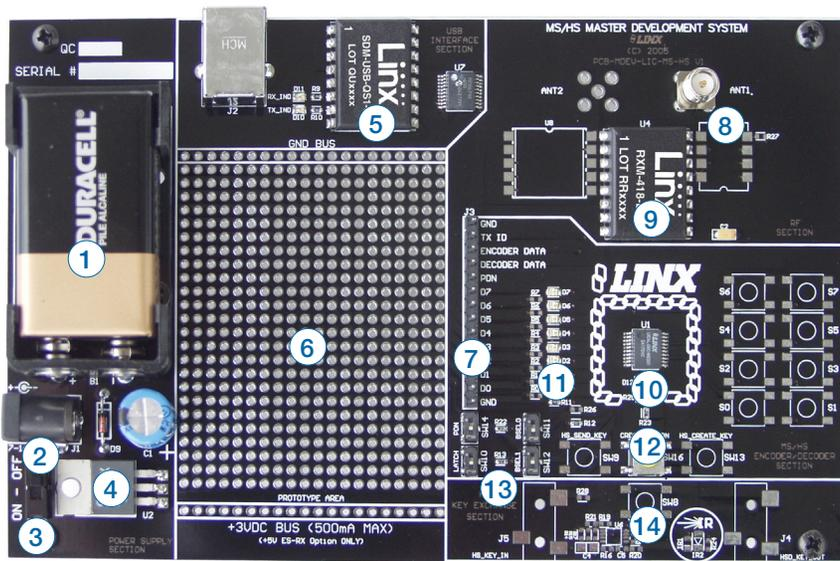

Figure 3: The MS Series Decoder Development Board

- | | |
|-------------------------|-----------------------------|
| 1. 9V Battery | 8. RP-SMA Antenna Connector |
| 2. Power Jack | 9. LR Series Receiver |
| 3. On-Off Switch | 10. MS Series Decoder |
| 4. Voltage Regulator | 11. Data Line LEDs |
| 5. QS Series USB Module | 12. Indicator LEDs |
| 6. Prototype Area | 13. Function Switches |
| 7. Break-Out Header | 14. LEARN Button |

Using the Master Development System

Using the Master Development System is straightforward. After unpacking the board, screw the antenna onto the connector, install the supplied 9V battery, and turn on the power switch. The encoder and decoder are configured from the factory and work straight out of the box. To create a new address (if desired), follow these easy steps:

1. Press and hold the CREATE button on the transmitter to create a new Code Word. This is done by sticking a paper clip through the hole on the back of the case and pressing the button inside. The Code Word is randomized for as long as the button is held down. Once comfortable that the number is sufficiently random, release the button.
2. Once the button is released, the MODE_IND LED begins flashing to indicate that it is ready to accept Control Permissions. Press all of the data line buttons that are to be recognized, then press the CREATE button again or let it time out after seventeen seconds.
3. Press the LEARN button on the decoder board and the MODE_IND LED starts flashing. Press any of the data line buttons on the transmitter and press the LEARN button again. The encoder's Code Word has now been learned by the decoder and they will operate together.

Troubleshooting

If the boards fail to work out of the box, then try the following:

- Check the battery to make sure it is not dead.
- Make sure the baud rate switches are set to 9,600bps on the decoder board.
- Make sure that the antenna is connected.
- Check to see if the PDN switch is on, placing the decoder into Power Down Mode. In most cases, the decoder PDN switch should be on.
- Make sure that the Control Permissions are set correctly. If the encoder has not been set to use a particular line, then when that button is pressed on the transmitter, the MODE_IND LED on the decoder board lights up, but the data line LED does not light up.

If all of these appear to be in order, then you can call +1 800 736 6677 or e-mail techsupport@linxtechnologies.com for technical support.

Setting the Transmitter Address

The MS Long-Range Handheld Transmitter allows the selection of one of 16,777,216 (2^{24}) unique addresses. All transmitters are supplied set to a unique address to avoid contention with other units; however, the address can be changed. This is accomplished by using a paper clip or probe to press the CREATE button on the board through the hole in the back of the case. Press the button and an LED lights up in the MODE_IND window,

MODE_IND Window



CREATE Button



Figure 4: CREATE Button Access

indicating that the address is being created. The address is randomized for as long as the button is held down. Release the button and the randomized address is saved and the LED begins flashing to indicate that the Control Permissions may now be set. Press the buttons that the transmitter should have the authority to access. Press the CREATE button with the paper clip again or wait 17 seconds for it to time out. The address and Control Permissions are now set. The decoder needs to learn the address before it will accept any transmissions. Please see the Typical Applications section of this data guide or the MS Series Decoder Data Guide for details.

OTX-***-HH-LR8-MS Button Assignments

Figure 5 illustrates the relationship between the button locations and encoder data lines.

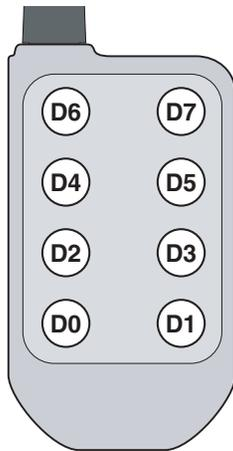

Figure 5: OTX-***-HH-LR8-MS Button Assignments

Contention Considerations

It is important to understand that only one transmitter at a time can be activated within a reception area. While the transmitted signal consists of encoded digital data, only one carrier of any particular frequency can occupy airspace without contention at any given time. If two transmitters are activated in the same area at the same time, then the signals will interfere with each other and the decoder will not see a valid transmission, so it will not take any action.

Battery Replacement

The remote unit utilizes a standard CR2032 lithium button cell. In normal use, it provides 1 to 2 years of operation. To replace the battery, remove the access cover by pressing firmly on the label area and sliding it off. Once the unit is open, remove the battery by sliding it from beneath the holder. Replace it with the same type of battery while observing the polarity shown in Figure 6.



Battery access

Figure 6: Battery Access

Assembly Diagram

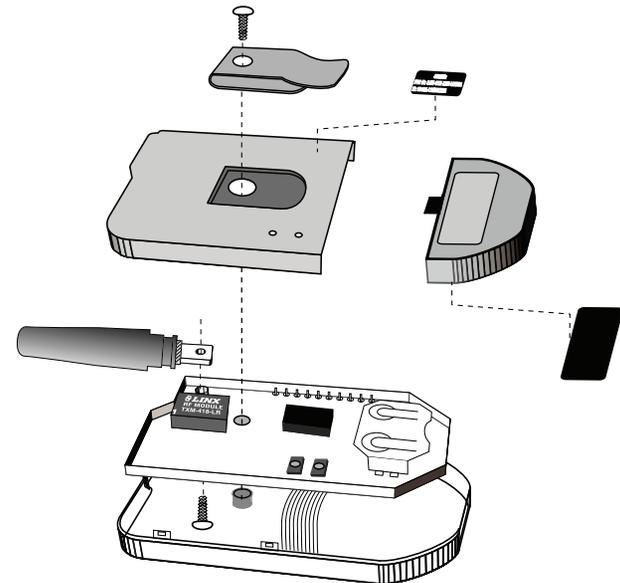

Figure 7: OTX-***-HH-LR8-MS Assembly

The Decoder Board

The decoder board included with the evaluation kit uses an LR Series receiver to receive the signal from the Handheld transmitter and then feeds it into an MS Series decoder. The board is designed to allow full access to the many features of the decoder and to speed development and integration of the LR and MS into a product. The following sections describe the features of this board in detail.

The Prototyping Area

The prototyping area on the decoder board contains a large section of plated through-holes so that external circuitry can be placed on the board. This circuitry can be interfaced with the MS Series decoder through the breakout header to the right of the holes. At the bottom of this area is a row connected to the 3V power supply and at the top is a row connected to ground.

All of the data lines are connected to a wire-wrap header to the right, allowing easy access from the prototyping area. The Decoder Data and TX ID lines are also available on the header as well as the PDN line from the RF module. This allows complete control of the entire system from the prototyping area, giving the designer a great deal of flexibility in using the board.

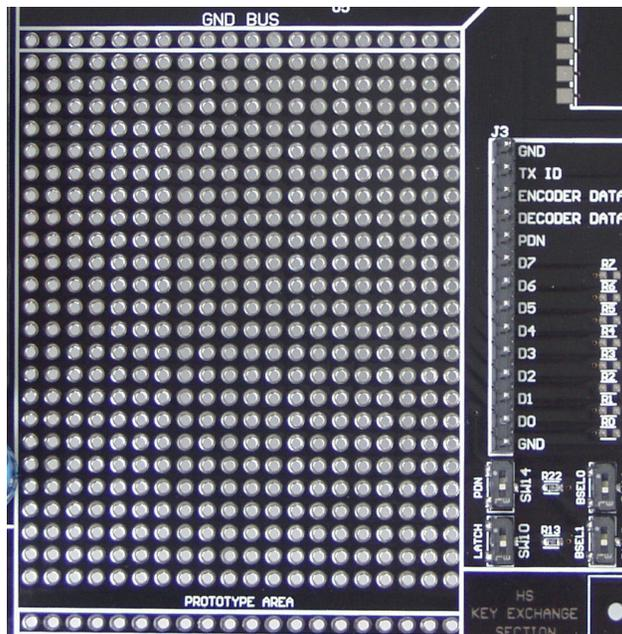

Figure 8: The Decoder Board Prototyping Area

The Power Supply

The power supply on the decoder board consists of a 9V battery and power jack connected to a 3.0V voltage regulator. It can provide approximately 500mA of current to the prototyping area, so if the added circuitry will need more than this, the designer must add an external supply. If the circuit consistently draws more than 100mA of current, it might be better to use the power jack rather than the battery, as the battery may run down fairly quickly, reducing testing and development time.

The jack accepts a standard 5.5mm plug with the tip ground and the outer shell 7 to 16VDC positive supply. While a reverse voltage protection diode has been included on the board to protect the circuitry in case the voltage on the plug is reversed, it is still a good idea to double-check the polarity.



Figure 9: The Decoder Board Power Supply Area

The RF Area

The Figure 10 shows the RF area of the development board. The board uses the LR Series receiver as shown. Attach the included antenna to the reverse polarity SMA connector before operation.

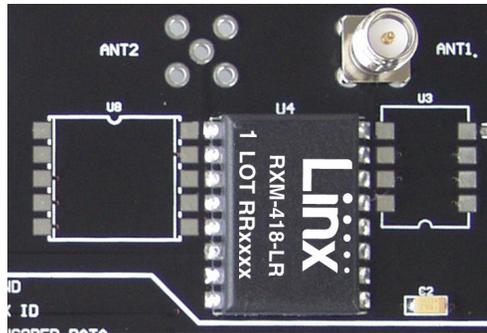

Figure 10: The Decoder Board RF Area

The Decoder Area

Figure 11 shows the decoder area of the development board.

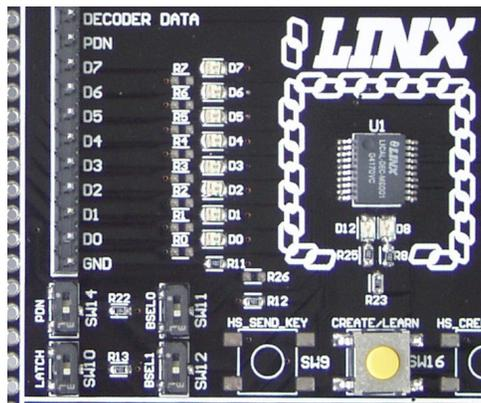

Figure 11: The Decoder Area

The decoder is in the center beneath the Linx logo. To the left are LEDs that are connected to the decoder data lines. These light up when the decoder receives a signal from the transmitter instructing it to take the data line high. LED D0 corresponds to data line D0 and so forth.

Beneath the decoder are two LEDs. D12 is connected to the MODE_IND line. D8 is connected to the RX_CNTL line and provides visual feedback by lighting up when the decoder activates the receiver when in RX Control Mode.

Under the LEDs is a button that is connected to the LEARN line. This button is used to learn the Code Word from the encoder as described in the MS Series Decoder Data Guide.

There are four switches to the left of the CREATE / LEARN button. BSEL0 and BSEL1 are used to set the baud rate of the decoder as shown in Figure 12. The Keyfob transmitter is set to 9,600bps, so BSEL0 should be on and BSEL1 should be off. If the switch is up, then the line is high (on); if down, then the line is low (off).

BSEL1	BSEL0	Baud Rate
0	0	2,400
0	1	9,600
1	0	19,200
1	1	28,800

Figure 12: Baud Rate Controls

Note: The decoder board must be set to the same baud rate as the transmitter in order for the signal to be received correctly.

The PDN switch connects the RX_CNTL line of the encoder to the PDN line of the receiver so that the RX Control Mode can be tested. This mode is described in the MS Series Decoder Data Guide.

The LATCH switch places the decoder into Latch Mode when on, so that the data lines go high when a valid signal is received and stay high until a second valid signal is received. If the switch is off, the data lines are momentary.

The USB Area

The decoder board has a Linx SDM-USB-QS-S USB module for use with the included development software. This module is powered by the USB bus, so it does not pull any current from the battery. Figure 13 shows this section.

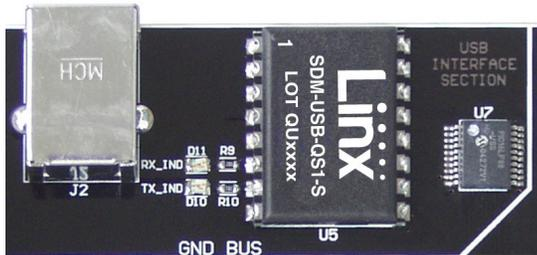

Figure 13: The Decoder Board USB Area

The microcontroller on the right monitors the data lines and generates commands that are sent to the development software on the PC via the QS Series USB module. The RX_IND LED to the left of the module flashes to indicate that data is being received from the PC, and the TX_IND line flashes to indicate that the module is sending data to the PC.

The QS Series USB module provides a simple serial link to a PC via a USB connection. It converts logic-level serial signals to USB-compliant signals and vice versa, so it can be connected to virtually any serial device, including microcontrollers, RS-232 / RS-485 level converters, or Linx RF modules. It is completely self-contained, requiring only a USB type B jack, and includes all necessary firmware and drivers.

Installing the Software and Drivers

The Master Development System uses the QS Series USB module to provide a simple serial interface to a PC via a USB connection. The module requires drivers to be installed on the PC before it can function properly. The QS Series Drivers are included on the CD with the software.

The first time the QS module is plugged into the computer, Windows displays the Found New Hardware Wizard, which guides the installation of the drivers. Application Note AN-00201 describes the installation of the drivers in detail. The drivers should be installed before running the Development Software.

The MS Master Development Software automatically starts when the CD is inserted and the player in Figure 14 appears.



Figure 14: Software Installer

Clicking the Install Software button starts the Installation Wizard, which guides the installation of the development software. The View Documentation button shows a list of the application notes and manuals related to the MS Series. Selecting one of these opens the file in Adobe Acrobat. The Play Movie button plays a short video about Linx on the Player Screen, which can be controlled with the Selection Keypad. Clicking the button on the bottom right of the player opens the Linx Technologies website in the computer's default browser.

The View Documentation list allows for the installation of Adobe Acrobat Reader so that the documents may be viewed. There is also the option of installing Flash, which may be required if the Linx video does not play correctly.

Master Development Software

This software is designed to give a complete understanding of how the MS Series encoders and decoders work together, as well as showing how they can be used in a system.

The Master Development software can be used in one of two modes. The default mode is a software simulation of the system and does not require any hardware. It simulates two handheld transmitters as well as two receiving devices. This is a good way of showing how the MS Series can work in a system by turning on lights and opening doors.

The second mode is for use with the Master Development System. When the decoder board is plugged into a USB port on the PC, the transmitter can be used to activate the features in the software. If the LEDs on the evaluation board turn on, then the LEDs in the program turn on and activate the corresponding data line function.

Figure 15 is a screen shot of the program set up in Software Operation Mode for simulating the operation of the system.



Figure 15: MS Encoder / Decoder Demonstration Software

The transmitters are on the right hand side and the receivers are at the bottom. Complete instructions for using the software can be found by clicking on the Help label at the top right of the window.

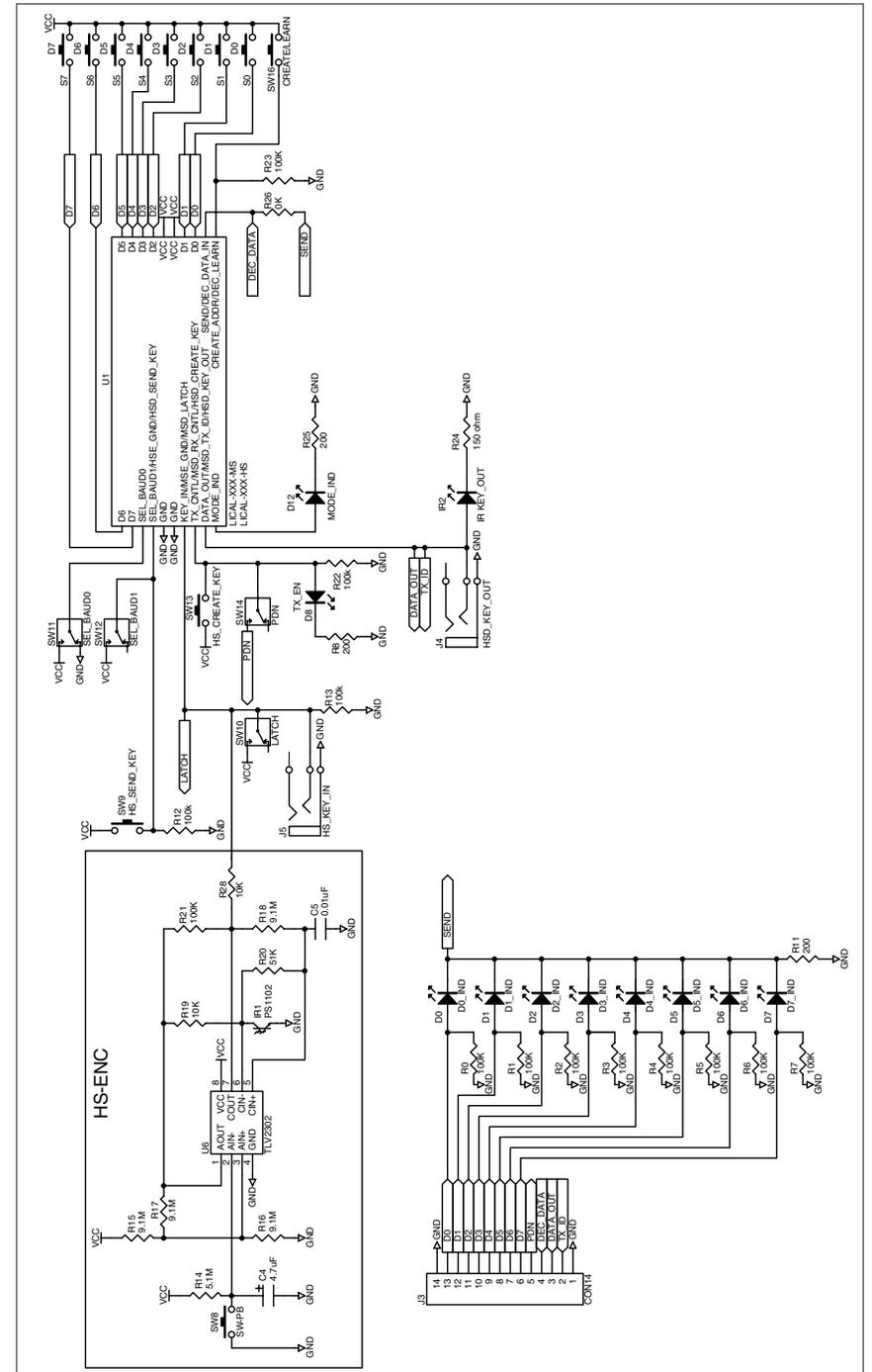

Figure 16: Encoder / Decoder Section

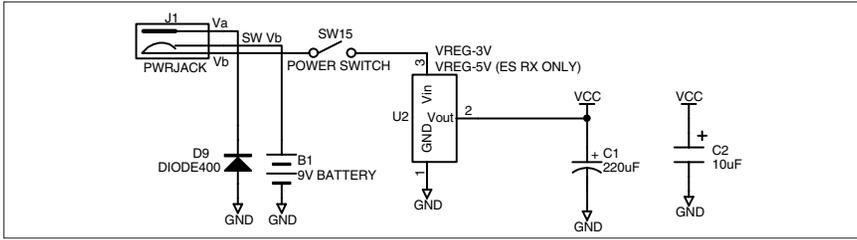

Figure 17: Power Supply Section

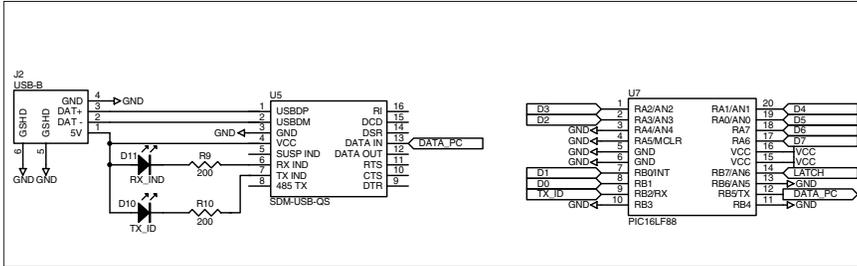

Figure 18: USB Section

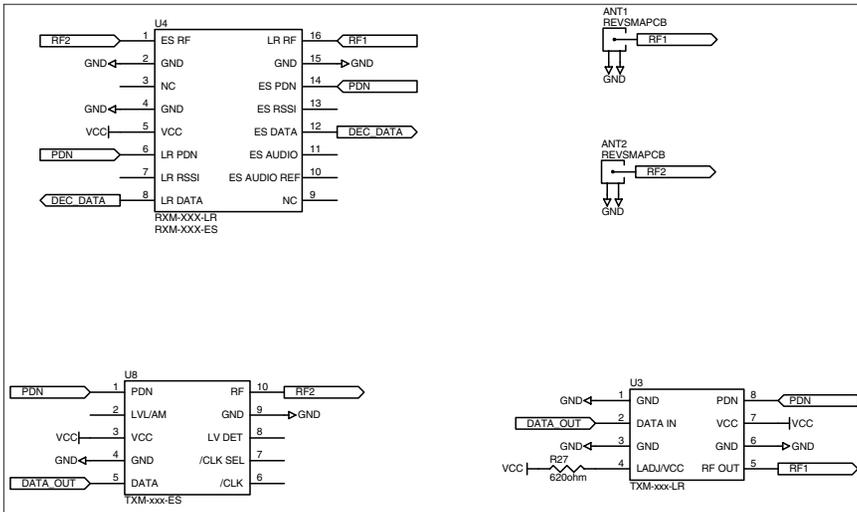

Figure 19: RF Section

Resources

Support

For technical support, product documentation, application notes, regulatory guidelines and software updates, visit www.linxtechnologies.com

RF Design Services

For customers who need help implementing Linx modules, Linx offers design services including board layout assistance, programming, certification advice and packaging design. For more complex RF solutions, Apex Wireless, a division of Linx Technologies, creates optimized designs with RF components and firmware selected for the customer's application. Call +1 800 736 6677 (+1 541 471 6256 if outside the United States) for more information.

Antenna Factor Antennas

Linx's Antenna Factor division has the industry's broadest selection of antennas for a wide variety of applications. For customers with specialized needs, custom antennas and design services are available along with simulations of antenna performance to speed development. Learn more at www.linxtechnologies.com.





Linx Technologies
159 Ort Lane
Merlin, OR, US 97532

Phone: +1 541 471 6256
Fax: +1 541 471 6251
www.linxtechnologies.com

Disclaimer

Linx Technologies is continually striving to improve the quality and function of its products. For this reason, we reserve the right to make changes to our products without notice. The information contained in this Data Guide is believed to be accurate as of the time of publication. Specifications are based on representative lot samples. Values may vary from lot-to-lot and are not guaranteed. "Typical" parameters can and do vary over lots and application. Linx Technologies makes no guarantee, warranty, or representation regarding the suitability of any product for use in any specific application. It is Customer's responsibility to verify the suitability of the part for the intended application. At Customer's request, Linx Technologies may provide advice and assistance in designing systems and remote control devices that employ Linx Technologies RF products, but responsibility for the ultimate design and use of any such systems and devices remains entirely with Customer and/or user of the RF products.

LINX TECHNOLOGIES DISCLAIMS ANY AND ALL WARRANTIES OF MERCHANTABILITY AND FITNESS FOR A PARTICULAR PURPOSE. IN NO EVENT SHALL LINX TECHNOLOGIES BE LIABLE FOR ANY CUSTOMER'S OR USER'S INCIDENTAL OR CONSEQUENTIAL DAMAGES ARISING OUT OF OR RELATED TO THE DESIGN OR USE OF A REMOTE CONTROL SYSTEM OR DEVICE EMPLOYING LINX TECHNOLOGIES RF PRODUCTS OR FOR ANY OTHER BREACH OF CONTRACT BY LINX TECHNOLOGIES. CUSTOMER AND/OR USER ASSUME ALL RISKS OF DEATH, BODILY INJURIES, OR PROPERTY DAMAGE ARISING OUT OF OR RELATED TO THE USE OF LINX TECHNOLOGIES RF PRODUCTS, INCLUDING WITH RESPECT TO ANY SERVICES PROVIDED BY LINX RELATED TO THE USE OF LINX TECHNOLOGIES RF PRODUCTS. LINX TECHNOLOGIES SHALL NOT BE LIABLE UNDER ANY CIRCUMSTANCES FOR A CUSTOMER'S, USER'S, OR OTHER PERSON'S DEATH, BODILY INJURY, OR PROPERTY DAMAGE ARISING OUT OF OR RELATED TO THE DESIGN OR USE OF A REMOTE CONTROL SYSTEM OR DEVICE EMPLOYING LINX TECHNOLOGIES RF PRODUCTS.

The limitations on Linx Technologies' liability are applicable to any and all claims or theories of recovery asserted by Customer, including, without limitation, breach of contract, breach of warranty, strict liability, or negligence. Customer assumes all liability (including, without limitation, liability for injury to person or property, economic loss, or business interruption) for all claims, including claims from third parties, arising from the use of the Products. Under no conditions will Linx Technologies be responsible for losses arising from the use or failure of the device in any application, other than the repair, replacement, or refund limited to the original product purchase price. Devices described in this publication may contain proprietary, patented, or copyrighted techniques, components, or materials.