



Chipsmall Limited consists of a professional team with an average of over 10 year of expertise in the distribution of electronic components. Based in Hongkong, we have already established firm and mutual-benefit business relationships with customers from,Europe,America and south Asia,supplying obsolete and hard-to-find components to meet their specific needs.

With the principle of “Quality Parts,Customers Priority,Honest Operation,and Considerate Service”,our business mainly focus on the distribution of electronic components. Line cards we deal with include Microchip,ALPS,ROHM,Xilinx,Pulse,ON,Everlight and Freescale. Main products comprise IC,Modules,Potentiometer,IC Socket,Relay,Connector.Our parts cover such applications as commercial,industrial, and automotives areas.

We are looking forward to setting up business relationship with you and hope to provide you with the best service and solution. Let us make a better world for our industry!



Contact us

Tel: +86-755-8981 8866 Fax: +86-755-8427 6832

Email & Skype: info@chipsmall.com Web: www.chipsmall.com

Address: A1208, Overseas Decoration Building, #122 Zhenhua RD., Futian, Shenzhen, China







VL-FS-MDLS161612D-02 REV. A
(MDLS161612D-LV-G-LED04G-IC-NT3881DH-01A)

JULY/2002

PAGE 1 OF 13

DOCUMENT NUMBER AND REVISION
VL-FS-MDLS161612D-02 REV. A
(MDLS161612D-LV-G-LED04G-IC-NT3881DH-01A)

DOCUMENT TITLE:
SPECIFICATION
OF
LCD MODULE TYPE
ITEM NO.: MDLS161612D-02

DEPARTMENT	NAME	SIGNATURE	DATE
PREPARED BY	PHILIP CHENG		2002/7/31
CHECKED BY	TOM LEE		2002/7/31
APPROVED BY	CYRUS CHEUNG		2002/7/31

DISTRIBUTION LIST: MARKETING



VL-FS-MDLS161612D-02 REV. A
(MDLS161612D-LV-G-LED04G-IC-NT3881DH-01AI)

JULY/2002

PAGE 2 OF 13

DOCUMENT REVISION HISTORY 1:

DOCUMENT REVISION FROM TO	DATE	DESCRIPTION	CHANGED BY	CHECKED BY
A	2002.07.31	First Release.	PHILIP CHENG	TOM LEE, Z.B.HE



CONTENTS

	<u>Page No.</u>
1. GENERAL DESCRIPTION	4
2. MECHANICAL SPECIFICATIONS	4
3. INTERFACE SIGNALS	7
4. ABSOLUTE MAXIMUM RATINGS	8
4.1 ELECTRICAL MAXIMUM RATINGS (Ta=25°C)	8
4.2 ENVIRONMENTAL CONDITION	8
5. ELECTRICAL SPECIFICATIONS	9
5.1 TYPICAL ELECTRICAL CHARACTERISTICS	9
5.2 TIMING SPECIFICATIONS	10
5.3 TIMING DIAGRAM OF VDD AGAINST V0	12
5.4 CORRESPONDENCE BETWEEN CHARACTER CODES AND CHARACTER PATTERNS (NOVATEK STANDARD NT3881D-01)	13

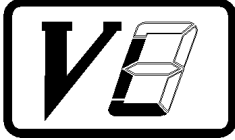

VARITRONIX LIMITED

Specification of LCD Module Type Item No.: MDLS161612D-02

1. General Description

- 16 characters (5 x 8 dots) x 1 line STN Positive Yellow Transflective Dot Matrix LCD module.
- Viewing Angle: 6 O'clock direction.
- Driving duty: 1/16 Duty, 1/5 bias.
- 'NOVATEK' NT3881DH-01/AI (die form) LCD Controller and Driver or equivalent
- Yellow-green LED04 backlight.

2. Mechanical Specifications

The mechanical detail is shown in Fig. 1 and summarized in Table 1 below.

Table 1

Parameter	Specifications	Unit
Outline dimensions	154.4(W) x 43.5(H) x 14.0 MAX.(D)	mm
Effective viewing area	119.4(W) x 18.7(H)	mm
Display format	16 characters x 1 line	-
Character size	5.90(W) x 12.70(H) (5 x 8 dots)	mm
Character spacing	1.00(W)	mm
Character pitch	6.90(W)	mm
Dot size	1.10(W) x 1.50(H)	mm
Dot spacing	0.10(W) x 0.10(H)	mm
Dot pitch	1.20(W) x 1.60(H)	mm
Weight	TBD	grams

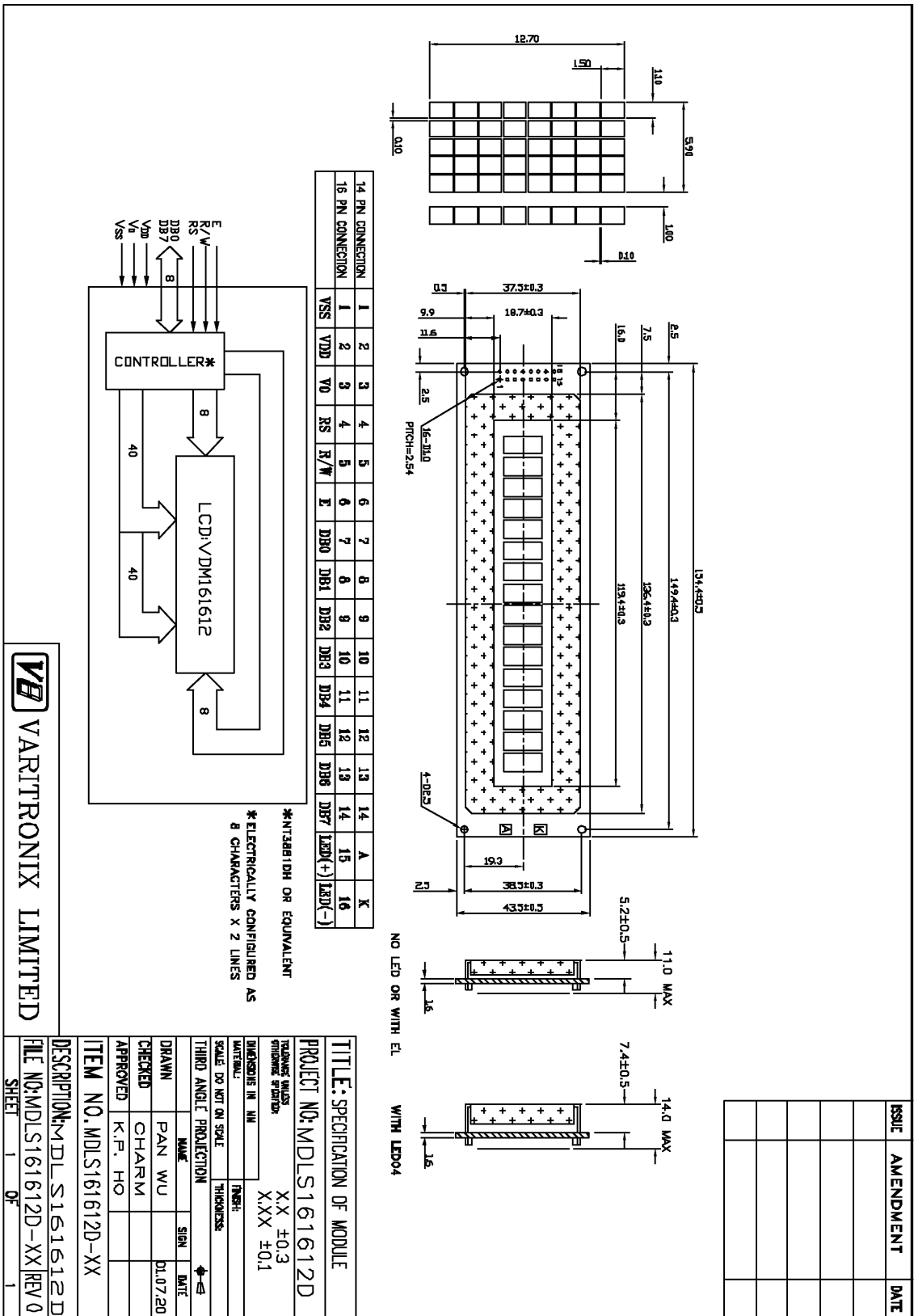

Figure 1: Outline Drawing

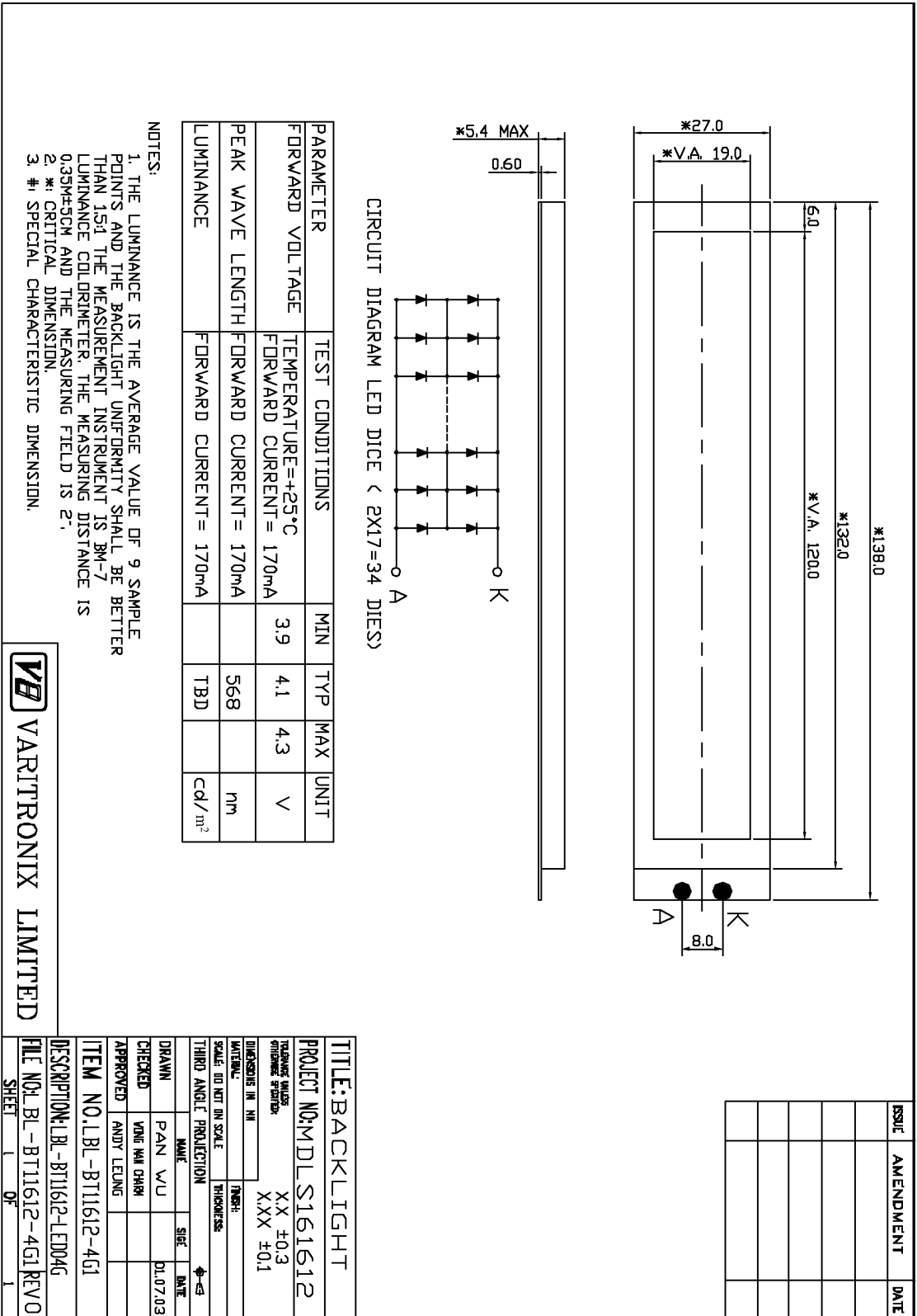

Figure 2: Backlight Drawing



3. Interface signals

Table 2

Pin No.	Symbol	Description
1	VSS	Ground(0V).
2	VDD	Power supply for logic (+5V).
3	V0	Power supply for LCD driver.
4	RS	Register Select Input: "High" for Data register (for read and write) "Low" for Instruction register (for write), Busy flag, address counter (for read).
5	R/W	Read/Write signal: "High" for Read mode. "Low" for Write mode.
6	E	Enable. Start signal for data read /write.
7	DB0	Data input/output (LSB).
8	DB1	Data input/output.
9	DB2	Data input/output.
10	DB3	Data input/output.
11	DB4	Data input/output.
12	DB5	Data input/output.
13	DB6	Data input/output.
14	DB7	Data input/output (MSB).
15 or A	LED(+)	Anode of LED backlight.
16 or K	LED(-)	Cathode of LED backlight.



4. Absolute Maximum Ratings

4.1 Electrical Maximum Ratings(Ta = 25 °C)

Table 3

Parameter	Symbol	Min.	Max.	Unit
Power Supply voltage (Logic)	VDD – VSS	-0.3	+7.0	V
Power Supply voltage (LCD drive)	VLCD=VDD – V0	-0.3	+13.5	V
Input voltage	Vin	-0.3	VDD +0.3	V

Note:

The modules may be destroyed if they are used beyond the absolute maximum ratings.

All voltage values are referenced to VSS = 0V.

4.2 Environmental Condition

Table 4

Item	Operating Temperature (Topr)		Storage Temperature (Tstg)		Remark
	Min.	Max.	Min.	Max.	
Ambient Temperature	0°C	+50°C	-10°C	+60°C	Dry
Humidity	95% max. RH for Ta ≤ 40°C < 95% RH for Ta > 40°C				no condensation
Vibration (IEC 68-2-6) cells must be mounted on a suitable connector	Frequency: 10 ~ 55 Hz Amplitude: 0.75 mm Duration: 20 cycles in each direction.				3 directions
Shock (IEC 68-2-27) Half-sine pulse shape	Pulse duration : 11 ms Peak acceleration: 981 m/s ² = 100g Number of shocks : 3 shocks in 3 mutually perpendicular axes.				3 directions



5. Electrical Specifications

5.1 Typical Electrical Characteristics

At $T_a = 25\text{ }^\circ\text{C}$, $V_{DD} = 5V \pm 5\%$, $V_{SS} = 0V$.

Table 5

Parameter	Symbol	Conditions	Min.	Typ.	Max.	Unit
Supply voltage (Logic)	VDD-VSS		4.75	5.00	5.25	V
Supply voltage (LCD)	VLCD =VDD-V0	VDD =5.0V, Note1.	4.1	4.5	4.9	V
Input signal voltage for E,DB0-DB7,R/W,RS.	V _{IH}	"H" level	2.2	-	VDD	V
	V _{IL}	"L" level	-0.3	-	0.8	V
Supply Current (Logic & LCD)	IDD	Character mode, Note 1	-	1.4	2.1	mA
Supply Current (LCD)	I0	Character mode, Note 1	-	1.0	1.5	mA
Supply Voltage of yellow-green LED04 backlight	VLED04	Forward current =170 mA No. of LED chips =2x17 =34	3.9	4.1	4.3	V

Note (1) : There is tolerance in optimum LCD driving voltage during production and it will be within the specified range.



5.2 Timing Specifications

At $T_a = 0\text{ }^{\circ}\text{C}$ To $+50\text{ }^{\circ}\text{C}$, $V_{DD} = +5V \pm 5\%$, $V_{SS} = 0V$.

Refer to Fig. 3, the bus timing diagram for write mode.

Table 6

Parameter	Symbol	Min.	Max.	Unit	Remarks
Enable cycle time	t_{CYCE}	500	-	ns	
Enable "High" level pulse width	t_{WHE}	300	-	ns	
Enable rise time	t_{RE}	-	25	ns	
Enable fall time	t_{FE}	-	25	ns	
RS, R/W set-up time	t_{AS}	60	-	ns	8-bit operation mode
		100			4-bit operation mode
RS, R/W address hold time	t_{AH}	10	-	ns	
Data output delay	t_{DS}	100	-	ns	
Data hold time	t_{DHR}	10	-	ns	

Refer to Fig. 4, the bus timing diagram for read mode .

Table 7

Parameter	Symbol	Min.	Max.	Unit	Remarks
Enable cycle time	t_{CYCE}	500	-	ns	
Enable "High" level pulse width	t_{WHE}	300	-	ns	
Enable rise time	t_{RE}	-	25	ns	
Enable fall time	t_{FE}	-	25	ns	
RS, R/W set-up time	t_{AS}	60	-	ns	8-bit operation mode
		100			4-bit operation mode
RS, R/W address hold time	t_{AH}	10	-	ns	
Read data output delay	t_{RD}	-	190	ns	
Read data hold time	t_{DHR}	20	-	ns	

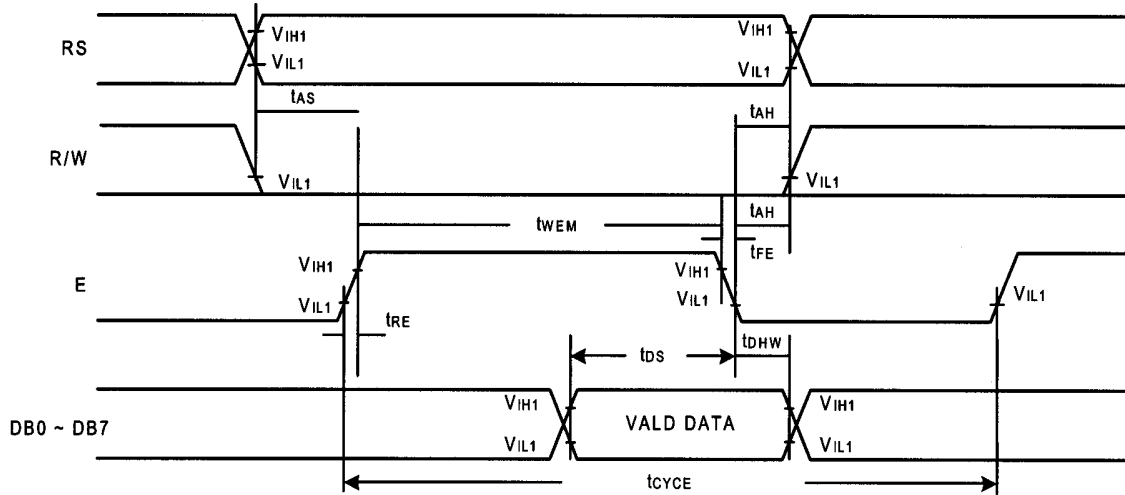

Figure 3: Bus write operation sequence (Writing data from MPU to NT3881).

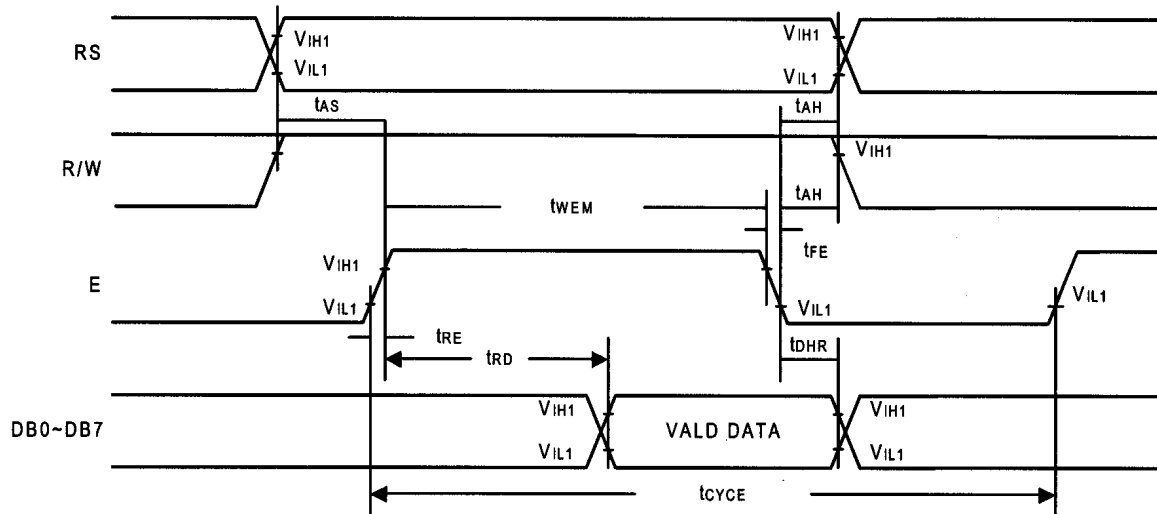

Figure 4: Bus read operation sequence (Reading out data from NT3881 to MPU).



5.3 Timing Diagram of VDD against V0.

Power on sequence shall meet the requirement of Figure 5, the timing diagram of VDD against V0.

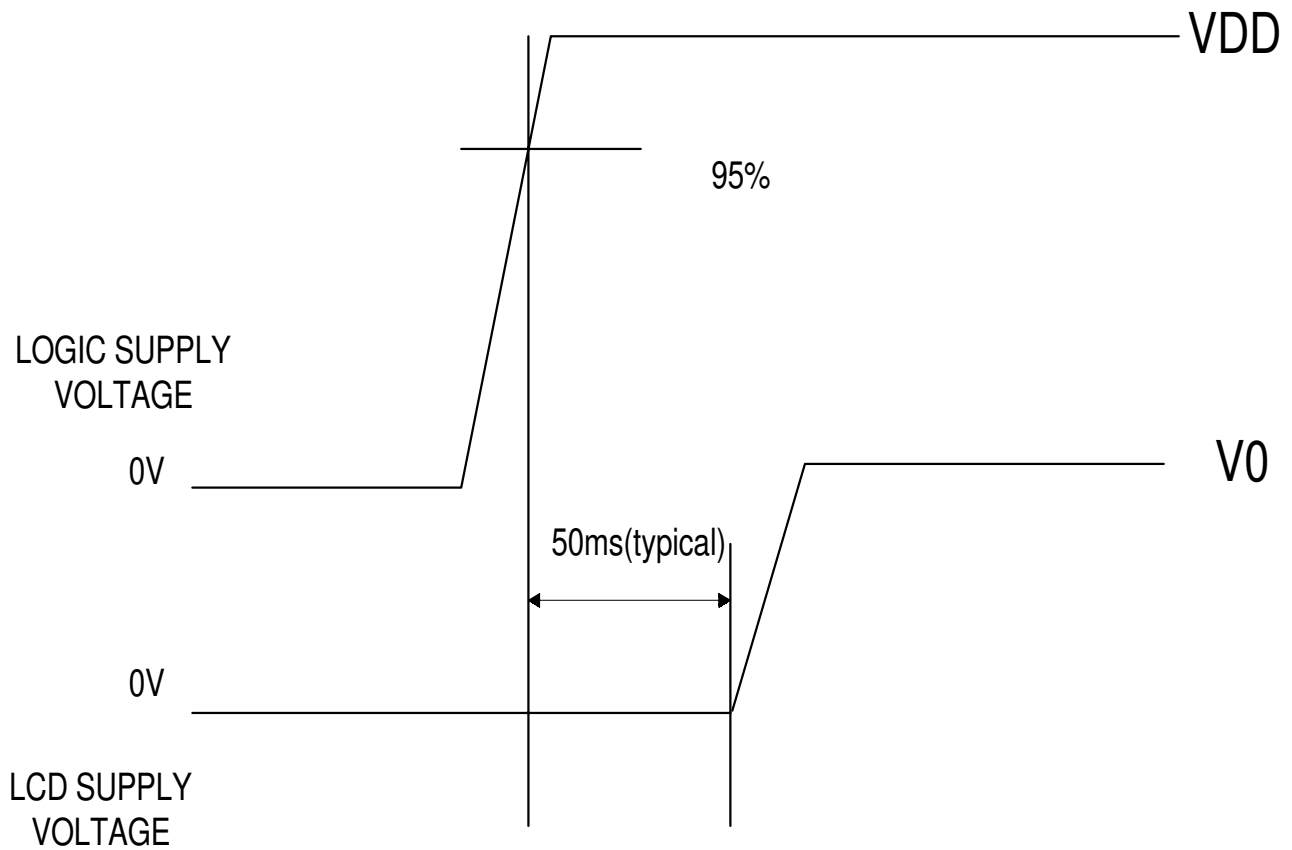
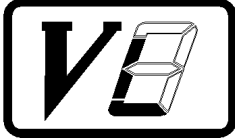

Figure 5: Timing diagram of VDD against V0.



**5.4 Correspondence between Character Codes and Character Patterns
 (NOVATEK Standard NT3881D-01)**

		Higher 4-bit (D4 to D7) of Character Code (Hexadecimal)																	
		0	1	2	3	4	5	6	7	8	9	A	B	C	D	E	F		
Lower 4-bit (D0 to D3) of Character Code (Hexadecimal)	0	CG RAM (1)			0	@	P	`	P					一	夕	三	α	ρ	
	1	CG RAM (2)		!	1	A	Q	a	q					。	ア	チ	△	Δ	q
	2	CG RAM (3)		"	2	B	R	b	r					「	イ	ツ	×	β	θ
	3	CG RAM (4)		#	3	C	S	c	s					」	ウ	テ	モ	ε	ω
	4	CG RAM (5)		\$	4	D	T	d	t					、	エ	ト	ト	μ	Ω
	5	CG RAM (6)		%	5	E	U	e	u					、	オ	ナ	1	ε	ü
	6	CG RAM (7)		&	6	F	V	f	v					ヲ	カ	ニ	ヨ	ρ	Σ
	7	CG RAM (8)		'	7	G	W	g	w					ア	キ	ヌ	ラ	g	π
	8	CG RAM (1)		(8	H	X	h	x					イ	ク	ネ	リ	γ	⊗
	9	CG RAM (2))	9	I	Y	i	y					ウ	ケ	ル	ル	γ	γ
	A	CG RAM (3)		*	:	J	Z	j	z					エ	コ	ル	レ	j	〒
	B	CG RAM (4)		+	;	K	[k	[オ	サ	ヒ	ロ	⊗	〒
	C	CG RAM (5)		,	<	L	¥	l	l					カ	シ	フ	ワ	φ	〒
	D	CG RAM (6)		-	=	M]	m]					ユ	ズ	ン	ト	ト	÷
	E	CG RAM (7)		.	>	N	^	n	→					ヨ	セ	ホ	ン	ン	
	F	CG RAM (8)		/	?	O	_	o	←					ッ	リ	マ	マ	ö	■

“Varitronix Limited reserves the right to change this specification.”

FAX:(852) 2343-9555.

URL:<http://www.varitronix.com>