



Chipsmall Limited consists of a professional team with an average of over 10 year of expertise in the distribution of electronic components. Based in Hongkong, we have already established firm and mutual-benefit business relationships with customers from,Europe,America and south Asia,supplying obsolete and hard-to-find components to meet their specific needs.

With the principle of “Quality Parts,Customers Priority,Honest Operation,and Considerate Service”,our business mainly focus on the distribution of electronic components. Line cards we deal with include Microchip,ALPS,ROHM,Xilinx,Pulse,ON,Everlight and Freescale. Main products comprise IC,Modules,Potentiometer,IC Socket,Relay,Connector.Our parts cover such applications as commercial,industrial, and automotives areas.

We are looking forward to setting up business relationship with you and hope to provide you with the best service and solution. Let us make a better world for our industry!



Contact us

Tel: +86-755-8981 8866 Fax: +86-755-8427 6832

Email & Skype: info@chipsmall.com Web: www.chipsmall.com

Address: A1208, Overseas Decoration Building, #122 Zhenhua RD., Futian, Shenzhen, China



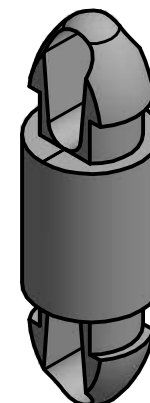
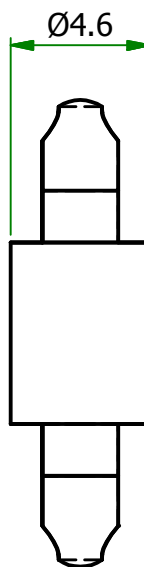
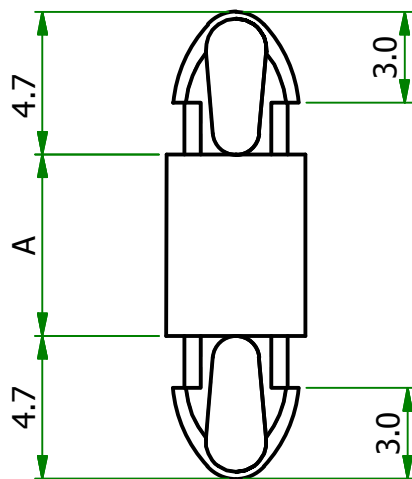
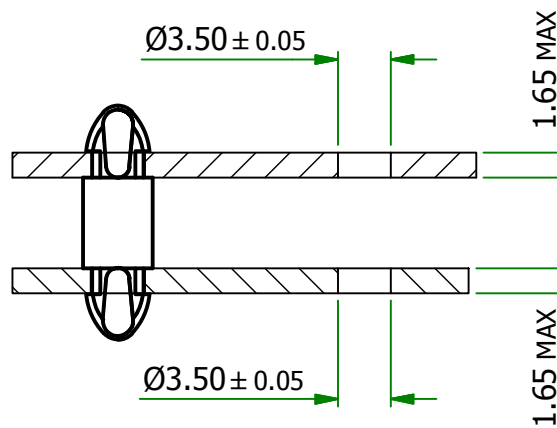
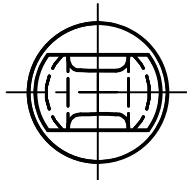

Part Number	UL94 RATING	COLOUR	A	Part ID
MDLSP2-16M-01	V2	NATURAL	16	1090430

UNCONTROLLED



ESSENTRA

essentracomponents.com

© 2013 Essentra Components. All rights reserved.
Registered in England, Company No. 547495.
Registered Office: Avebury House,
201-249 Avebury Boulevard, Milton Keynes, MK9 1AU

Condition of Sale can be found on our website:
essentra.com.

Essentra Components does not warrant that the files will be error free and may create new versions ("Upgrades") at any time, which may correct such errors. Essentra Components has no obligation to notify you of such upgrades. Any upgraded file will be published to the website, when it becomes available.

You are not permitted to load any of the files on to a network server for the purposes of distribution to one or more other computer(s) on that network or to effect such distribution. Essentra Components shall not be liable for any loss or damage whatsoever or however caused, arising directly or indirectly from the use of the files.

UNLESS OTHERWISE STATED

ALL DIMENSIONS IN mm				DO NOT SCALE	
LINEAR TOLERANCE				THIRD ANGLE PROJECTION	
SIZE	(0)	(0.0)	(0.00)	 ANGULAR TOLERANCE ± 0.5 DEGREES UNSPECIFIED RADII 0.25mm DRAFT ANGLE 0.5 DEGREES DIMENSIONS IN BRACKETS [] ARE IN INCHES FOR REFERENCE ONLY	
0-10mm	± 0.5	± 0.15	± 0.10		
10-30mm	± 0.5	± 0.20	± 0.15		
30-50mm	± 0.5	± 0.30	± 0.20		
50-100mm	± 0.8	± 0.50	± 0.25		
100-200mm	± 1.5	± 0.80	± 0.40		
200-300mm	± 2.0	± 1.20	± 0.80		
300-500mm	± 3.0	± 2.00	± 1.00	CREATE DATE: 14/Mar/2014	
+500mm	± 5.0	± 3.00	± 1.50		

ORG.SCALE NTS

MATERIAL NYLON 6.6

ITEM No. MDLSP2-16M-01

TITLE
MINI SUPPORT POST

DWG.No. P160344-3

ISSUE No. 2