



Chipsmall Limited consists of a professional team with an average of over 10 year of expertise in the distribution of electronic components. Based in Hongkong, we have already established firm and mutual-benefit business relationships with customers from,Europe,America and south Asia,supplying obsolete and hard-to-find components to meet their specific needs.

With the principle of “Quality Parts,Customers Priority,Honest Operation,and Considerate Service”,our business mainly focus on the distribution of electronic components. Line cards we deal with include Microchip,ALPS,ROHM,Xilinx,Pulse,ON,Everlight and Freescale. Main products comprise IC,Modules,Potentiometer,IC Socket,Relay,Connector.Our parts cover such applications as commercial,industrial, and automotives areas.

We are looking forward to setting up business relationship with you and hope to provide you with the best service and solution. Let us make a better world for our industry!



## Contact us

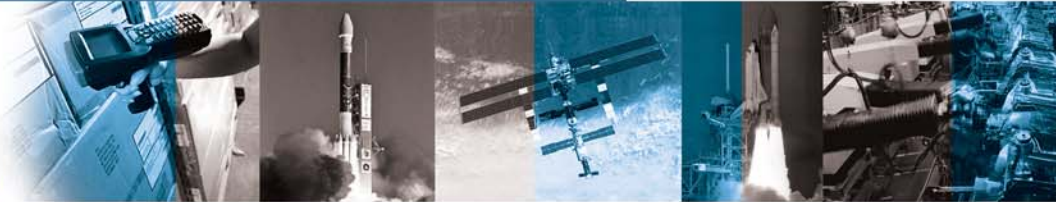
Tel: +86-755-8981 8866 Fax: +86-755-8427 6832

Email & Skype: info@chipsmall.com Web: www.chipsmall.com

Address: A1208, Overseas Decoration Building, #122 Zhenhua RD., Futian, Shenzhen, China



# Cannon Microminiature Connectors





# Cannon Microminiature Products



## High Performance Micro Miniature Connectors

ITT Cannon is a division of ITT Inc. Developed first by Cannon in the 1960s, Cannon's Micro Connector portfolio has witnessed many product extensions since then, and it remains the most extensive in the industry, offering the most reliable and cost effective range of micro interconnect solutions. These innovations have enabled ITT to provide products and technologies to such markets as:

- Aerospace
- Computers Systems
- Defense Electronics
- Geophysical
- Industrial Automation
- Medical Electronics
- Network Systems
- Telecom Switching
- Underwater Systems
- Wireless

Offering the broadest selections of standard and custom micro interconnect solutions, ITT is the one stop source for design, development, manufacturing, and test of sophisticated multi channel high density connectors. Our product portfolio consists of rectangular, circular, quick disconnect, high speed signal, filter, hermetic, mixed signal packages, and strip style interconnects. Each product has unique mechanical engagement and locking mechanisms to meet the demands of harsh environment applications. These products include our Centi Line .100-inch and .075-inch center spacing, the Micro line .050 inch center spacing, and our Nano line of .025-inch center contact spacing. All of ITT's micro connectors utilize our twist pin contact

system, developed by ITT in the early 1960's. A separate section describes in detail the twist pin electrical contact technology (refer to page 6).

## The Standard of Six Sigma

When you specify a Cannon microminiature connector, you can rely on a product designed, developed, and manufactured to the highest quality and reliability standards in the industry. This tradition of excellence is based on ITT's corporate culture of operating its entire business under the



principles of Six Sigma. At ITT, Six Sigma is not just a quality philosophy but a complete corporate culture that drives the entire business. Our Value Based

Management and Value Based Product Development systems are two cornerstones of ITT that allows for the development of both leadership and product development principles, ensuring that the correct industry leading products are



developed to the accepted market driven lead times. These principles have allowed ITT to become the market leader

in all of our business portfolios.

## Six Sigma Engineering

ITT, utilizing its six sigma tools and multiple lean initiatives, offers the most experienced engineering design team in



the micro miniature interconnect field. Using our systems approach, ITT continues to advance new interconnect technologies by developing advanced products including higher density Nano 0.025-inch spacing interconnects, Chip-on-Flex filter connectors, flexible high density circuits terminated directly to ITT contacts, and innovative high speed mixed signal connector configurations.

In conjunction with our design teams, ITT operates a world class test lab offering state of the art capabilities in electronic, fiber optic, and mechanical test expertise. Our certified test engineers and technicians can develop a specific test plan based on our customer's specific needs. Additionally, our team is experienced in providing test services and programs for US DOD Defense electronics and Space related programs.



## Six Sigma Manufacturing

ITT operates manufacturing facilities in the United States, France, Germany, Italy, Mexico, China, and the UK, all of



# Cannon Microminiature Products

which have particular product area strengths allowing ITT to offer a truly global footprint to our customers. Our facilities are world class and accommodate full vertical integration with the latest manufacturing technologies including: automated and robotic machining centers, Super Market manufacturing cells, Kanban pull systems, and automated electrical, mechanical, and optical test and inspection equipment. The combination of our manufacturing strength and our advanced manufacturing facilities allows ITT to offer products at market driven prices. Our capabilities, especially in robotics, computerized precision tooling, Kaizen Project Management, Six Sigma tools, and test labs, gives ITT the most optimized global manufacturing footprint in the interconnect industry.



viding terminated flex circuit assemblies, high temperature geophysical cable assemblies, innovative medical electronics cable assemblies, over mold strain relief systems, and EMI shielded terminations.

## RoHS Compliance Information

ITT has implemented a strict parts control plan for all ITT electronics plants worldwide that allows the Cannon Microminiature



connector product portfolio to meet the requirements of European Union Directive 2002/95/EC better known as the Reduction of Hazardous Substances initiative. To make things easier for our customers, all Cannon Microminiature products can be ordered with an R prefix number which insures our customers will receive RoHS compliant parts for their commercial electronics applications and equipment. Since most RoHS hazardous substances center around specific metal plating and lead solder coatings, ITT's products for RoHS compliance are available in the following plating finishes: electroless nickel, stainless steel, Anodize over aluminum and Gold plating. It should be noted that gold plating would be recommended as the replacement for tin-lead solder when ordering board mount connectors.



## The Custom Difference

As the industry leader in harsh environment interconnect applications, ITT's world class engineering teams will work directly

with our customers to design and develop cost effective solutions for their applications. In many cases we may modify one of our standard designs to ensure a highly reliable solution where timing is critical. Yet, in those cases where a complete custom interconnect solution is required, ITT will work with our customer's Engineers to design an interconnect solution which will be cost effective yet highly reliable. As professional consultants, our Engineering teams will provide a thorough systems and mechanical analysis of any proposed solution. These analyses provide our customers with sophisticated electrical signal and mechanical characterizations to determine the best solution for their application.



## Non Compliant RoHS Materials

Advanced Aerospace specifications and DOD system performance requirements demand the necessity to maintain production status for the primary base metals and Chem film coatings typically utilized in Aerospace electronics. Thus, in order to support ITT's Aerospace customer base and maintain

our leadership position in micro miniature connector technologies, ITT will continue to provide interconnect products with cadmium plating and tin lead solder in support of these markets. These materials are designed to be comparable to M83513.



In addition to custom connectors, ITT offers sophisticated custom cable assembly capabilities for a wide range of harsh environment applications.

Our in house expertise translates to our ability to integrate different technologies within a custom cable harness. ITT's capabilities include discrete wire terminations to multi wire cable harnesses with multiple connector configurations as part of the final assembly. We also specialize in pro-



Please consult Customer Service if RoHS part verification is required.













# Table of Contents

Introduction . . . . .	2
Microminiature Product Overview Guide . . . . .	5
Twist Pin Contact System . . . . .	6
Micro-D Metal Shell - .050" Contact Spacing (MDM) . . . . .	7
Micro-D PCB - .050" Contact Spacing (MDM-PCB) . . . . .	18
Micro-D Coaxial/Power - .050" Contact Spacing (MDM-C/P) . . . . .	22
Hermetic (MDMH) . . . . .	23
Filter (TMDM) . . . . .	25
Micro-D Plastic Shell - .050" Contact Spacing (MD/MDV) . . . . .	28
Micro Center Jackscrew (MJS) . . . . .	39
Microminiature Circular - .050" Contact Spacing (MIK, MIKM, MIKQ) . . . . .	44
Microstrips .050" Contact Spacing (MT) . . . . .	48
Microminiature Strip - .100/.050" Contact Spacing (MT) . . . . .	52
Micro Edgeboard - .050" Contact Spacing (MEB) . . . . .	54
The Centi Line - .075" Contact Spacing (2D) . . . . .	59
Centi-D Loc-.075" Contact Spacing (CDL) . . . . .	65
Strip Connectors - .100"/.075" Contact Spacing . . . . .	66
The NANO Line - .025" Contact Spacing . . . . .	70
Strip Connectors - .025" Contact Spacing (NT) . . . . .	71
NANO D Metal Shell - .025" Contact Spacing (NDM) . . . . .	72
Center Jackscrew - .030" Contact Spacing (NJS) . . . . .	73
Custom Cable Assemblies . . . . .	75
Flex Circuit Cable Assembly . . . . .	77
Custom Back Shells . . . . .	78
Appendix	
Standard Wire Termination "L" Code Chart . . . . .	79
Standard Wire Termination "H" Code Chart . . . . .	81
Wire Color Code Chart . . . . .	83
Terminology . . . . .	84
Product Safety Information . . . . .	85



# Cannon Microminiature Product Overview Guide

	MDM	MDM PCB	MDM C/P	MDMH Hermetics	TMDM Filter	MD**	MDB Coaxial	MJS	MIK	MIKM
										
<b>Type</b>	Plug and Socket	Plug and Socket	Plug and Socket	Plug and Socket	Plug and Socket	Plug and Socket	Plug and Socket	Plug and Socket	Plug and Socket	Plug and Socket
<b>Current Rating</b>	3A max.	3A max.	3A max.	3A max.	3A max.	3A max.	3A max.	3A max.	3A max.	3A max.
<b>Contact Resistance</b>	8 milliohms max.	8 milliohms max.	8 milliohms max.	24 milliohms max.	15 milliohms max.	8 milliohms max.	8 milliohms max. (signal)	8 milliohms max.	8 milliohms max.	8 milliohms max.
<b>Contact Material</b>	gold plated copper alloy	gold plated copper alloy	gold plated copper alloy	gold plated copper and steel	gold plated copper alloy	gold plated copper alloy	gold plated copper alloy	gold plated copper alloy	gold plated copper alloy	gold plated copper alloy
<b>Shell</b>	Metal	Metal	Metal	Metal	Metal	Plastic	Plastic	Plastic	Plastic	Metal
<b>Shell Material</b>	Aluminum	Aluminum	Aluminum	Steel	Aluminum	Thermoplastic & Thermoset	Thermoset	Thermoplastic & Thermoset	Thermoplastic	Steel
<b>Available Layouts</b>	9, 15, 21, 25, 31, 37, 51 & 100	9, 15, 21, 25, 31, 37, 51 & 100	7C/P2, 24C/P4, 27C/P5 & 10C/P10	9, 15, 21, 25, 31, 37 & 51	9, 15, 21, 25, 31, 37 & 51	9, 15, 21, 25, 31, 37 & 51	7C/P2	10, 26, 51 & 66 - Rect/unshrouded 16, 28 & 35 - Rect/shrouded 26, 38, 42 & 76 - Polarized D	7 & 55	7, 55 & 85
<b>Configuration</b>	Polarized D	Polarized D	Polarized D	Polarized D	Polarized D	Polarized D	Polarized D	Rectangular & Polarized D	Circular	Circular
<b>RoHS</b>	Available	Available	Available	Available	No	Available	Available	Available	Available	Available
<b>Factory Terminated</b>	Yes*	Yes	Yes	Yes*	Yes	Yes*	Yes	Yes*	Yes	Yes
<b>Space Applications</b>	Available	Available	Available	Yes	Yes	Available	Available	Available	Yes	Yes
<b>Page Number</b>	7	18	22	23	25	28	32	39	44	44

	MIKQ	MT*	MEB	2D	CDL	CTA*	NDM	NTP	NJS
									
<b>Type</b>	Plug and Socket	Plug and Socket	Plug and Socket	Plug and Socket	Plug and Socket	Plug and Socket	Plug and Socket	Plug and Socket	Plug and Socket
<b>Current Rating</b>	3A max.	3A max.	3A max.	5A max.	5A max.	5A max.	1A max.	1A max.	1A max.
<b>Contact Resistance</b>	8 milliohms max.	8 milliohms max.	8 milliohms max.	9 milliohms max.	9 milliohms max.	9 milliohms max.	60 milliohms max.	60 milliohms max.	60 milliohms max.
<b>Contact Material</b>	gold plated copper alloy	gold plated copper alloy	gold plated copper alloy	gold plated copper alloy	gold plated copper alloy	gold plated copper alloy	precious metal alloy & gold plated copper alloy	precious metal alloy & gold plated copper alloy	precious metal alloy & gold plated copper alloy
<b>Shell</b>	Metal	Plastic	Plastic	Plastic	Plastic	Plastic	Metal	Plastic	Plastic
<b>Shell Material</b>	Steel	Thermoplastic	Thermoset	Thermoplastic	Thermoplastic	Thermoplastic	Thermoset	Thermoset	Thermoplastic
<b>Available Layouts</b>	7, 19 & 37	MTV - 1 thru 120 MTB - 1 thru 80	64, 128, 92 & 184	19, 31, 52, 79 & 100	139	CTA3 - 1 thru 53 CTA4 - 1 thru 60	9, 15, 21, 25, 31 & 37	1 thru 40	Rectangular - 9, 24 & 44 Circular - 27, 72 & 246
<b>Configuration</b>	Circular	Strip	Polarized D	Polarized D	Polarized D	Strip	Polarized D	Strip	Rectangular & Circular
<b>RoHS</b>	Available	Available	Available	Available	Yes	Yes	Yes	Yes	Yes
<b>Factory Terminated</b>	Yes	Yes*	Yes*	No	No	No	Yes	Yes	Yes
<b>Space Applications</b>	Yes	Yes	Yes	No	No	No	Yes	Yes	Yes
<b>Page Number</b>	44	48	54	59	65	66	72	71	73

\* Solderpot versions available for end user termination

Dimensions shown in inch (mm)  
Specifications and dimensions subject to change

www.ittcannon.com





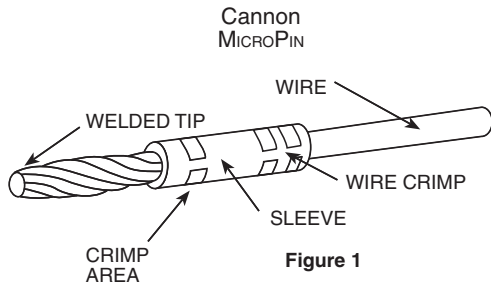


Figure 1

### Pos-A-Line Contact Alignment

The flexible twist-pin is recessed into the insulator and the rigid socket is exposed, reversing the traditional positions of pin and socket. During mating, the socket is guided into the pin insulator by the lead-in chamfer. The pin is kept from flexing beyond the socket capture radius by the walls of the cavity. The hemispherical weld of controlled radius at the tip of the pin combines with the lead-in chamfers of the socket contact and the pin insulator to cam the pin into alignment. By controlling the welding process and the dimensions of the socket contact and the insulators, it is impossible for the recessed pin to escape the socket capture radius.

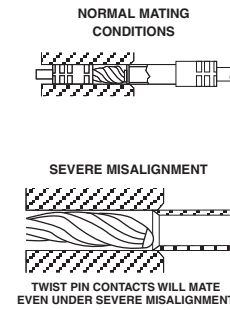


Figure 2

### Twist Pin Contact Technology

The foundation of ITT's Cannon Micro Connector portfolio starts with ITT's innovative twist pin contact system. This system was originally developed in the early 1960's and ITT was one of the original interconnect companies to license this technology and improve it. Our forty five years of experience in manufacturing and establishing a fully automated manufacturing system for this contact has truly given ITT the foremost knowledge in twist pin contact technology.

As the core of our micro products, the twist pin contact offers a superior electrical and mechanical system that outperforms traditional machined or stamped electrical contract systems. ITT's twist pin system consists of the Micro Socket and the Micro pin or Twist pin. Figure 1 show the basic contacts.

### Figure 1

The twist pin contact system consists of several stranded cores making up the wire bundle. The strands are subsequently heat treated and a weld is performed on the tip of each contact. Crimp sleeves are then inserted over the contact and crimp areas are defined to produce a seamless crimp system. The entire twist pin system is referred by ITT as a Pos-A-Line contact alignment system. Our reference to this system identifies that the flexible twist pin is recessed into the insulator and the rigid socket is exposed thus reversing the traditional positions of the pin and socket. During the mating sequence, the socket is guided into the pin insulator by the lead-in chamfer. The pin is kept from flexing beyond the socket capture radius by the walls of the cavity. The hemispherical weld of controlled radius at the tip of the pin combines with the lead-in chamfer of the socket contact and the pin insulator to cam the pin in alignment. ITT has developed a very robust Six Sigma manufacturing process that controls the welding process as well as the dimensions of the socket con-

tact and insulator material. The net result is a contact system that makes it impossible for the recessed pin to escape the socket capture radius. Figure 2 shows the twist pin features as well as mating and severe misalignment conditions.

The advantages of ITT's twist pin contact system are many and have been field proven in the most demanding applications and environments for over forty five years. Some of these advantages include:

- Seven points of electrical contact (Micro 0.050-inch & Centi Line 0.075-inch Interconnect Products)
- Five points of electrical contact (Nano 0.025-inch Interconnect Products)
- Contact and crimp sleeve materials carefully optimized for extremely reliable crimps- No design tradeoffs
- Seamless crimp sleeves
- Multiple 4-indent wire crimps standard and smaller bore micro socket contacts
- Standard integral tail & thru bundle micro pin contacts (high density packaging)
- High mating cycles
- High current handling capabilities
- System qualification in numerous Aerospace, Defense Electronic, and high temperature Geophysical applications.
- Wide array of wire terminations

The advantages listed above are by no means inclusive of ITT's innovative product improvement processes. Moving forward, ITT plans to introduce additional new product features supporting enhanced twist pin contact performance.





MDM connectors are used in applications requiring highly reliable, extremely small, lightweight connectors with higher density contact configurations than available in traditional rectangular connectors. They are available in 8 shell sizes accommodating from 9 to 100 contacts, and special arrangements of power and coaxial contacts.

These connectors are designed to meet the rapidly increasing demands for an environmental, high performance, rugged, moisture-sealed microminiature connector. This connector

employs size 24 MICROPIN™/MICROSOCKET™ contacts on .050 (1.27) centers in a contact density identical to the standard MICRO-D connector series, but with these additional features:

- Aluminum shells to provide greater strength, prevent chipping, cracking or breaking, offer electromagnetic (EMI) and RFI shielding.
- Silicone elastomer compression interfacial seal to provide a moisture and humidity seal between each contact and between contacts and shell.

## Specifications

### STANDARD MATERIALS AND FINISHES

Shell	- 6061-T6 Aluminum alloy per QQ-A-200/8, yellow chromate/cadmium, Type II, Class 3 over electroless nickel per SAE AMS-C-26074, Class 4.
Insulator	- Liquid Crystal Polymer per MIL-M-24519, Type GLCP-30F (9-100) - Glass filled diallyl phthalate per MIL-M-14, Type SDGF (7*2 and 24*4) - Polyphenylene sulfide per MIL-M-24519, Type GST-40F (16*5) - Polyester per MIL-M-24519, Type GPT-30F (10*10)
Contacts	- Copper alloy, gold plate
Mounting Hardware	- 300 Series stainless steel, passivate
Kit, Jackpost (3) items	- 300 Series stainless steel, passivate
Washer	- 400 Series stainless steel, passivate
Standard Epoxy	- Hysol EE4215/HD3561, color black or Hysol EE4198/HD3561, color green

### MECHANICAL FEATURES

Coupling	- Friction/jackscrews
Polarization	- Keystone-shaped shells
Contact Spacing Centers	- .050 (1.27)
Shell Styles	- Plug and receptacle
No. of Contacts	- 9 thru 100 signal; 5 signal/2 coaxial; 5 signal/2 power; 11 signal/5 coaxial; 11 signal/5 power; 0 signal/10 coaxial; 0 signal/10 power; 20 signal/4 coaxial; 20 signal/4 power
Coaxial Cable	- RG - 178/U
Wire Size	- #24 thru #32 AWG
Contact Termination	- Multiple indent crimp

## Performance Data

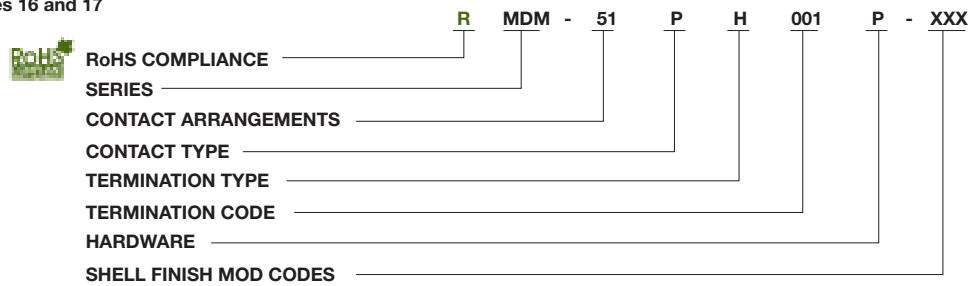
The table below summarizes the results of key tests performed in accordance with MIL-STD-1344, where applicable. Data is applicable to standard connectors with standard termination. Variations may affect this data, so please consult customer service for further information on your requirements.

Test	Method	Criteria of Acceptance
Dielectric Withstanding Voltage	Method 3001: 600 VAC at sea level 150 VAC at 70,00' altitude	No breakdown No breakdown
Insulation Resistance	Method 3003	5,000 megohms minimum
Thermal Shock	Method 1003, Condition A: - 55°C to +125°C	No physical damage
Physical Shock	Method 2004, Condition E: 50 G's, 3 axes, 6 millisecond duration sawtooth pulse	No physical damage No loss of continuity > 1 µsec
Vibration	Method 2005, Condition IV: 20 G's, 10-2,000 Hz. 12 hrs	No physical damage No loss of continuity > 1 µsec
Durability	500 cycles of mating and unmating, 500 CPH max.	No mechanical or electrical defects
Moisture Resistance	Method 1002, Type II, omit steps 7a & 7b	Insulation resistance > 100 megohms
Salt Spray	Method 1001, Condition B: 48 hours	Shall be capable of mating and unmating, and meet contact resistance requirements
Contact Resistance (MIL-STD-202)	Method 1001, Condition B: At 3 amps At 1 milliamp	8 milliohms maximum 10 milliohms maximum
Contact Retention	Per 83513-Style	5 lb. minimum axial load



## How to Order

For 83513-Style ordering information see pages 16 and 17



### SERIES

MDM: (Size 9-100) Liquid Crystal Polymer (LCP)  
MDM: (Combo Layout) Diallyl Phthalate (DAP)

### CONTACT ARRANGEMENTS

9-15-21-25-31-37-51-100 (standard)  
16C5, 10C10, 7C2, 24C4 (coaxial) } or combination of  
16P5, 10P10, 7P2, 24P4 (power) } coax and power

### CONTACT TYPE

P - Pin S - Socket

### TERMINATION TYPE

H - Harness-insulated wire.  
L - Solid-uninsulated wire.  
S - Solder pot to accept #26 AWG MAX.  
harness wire. (Not available with power  
contact arrangements.)

### HARDWARE

M - Military specification hardware, see  
page 11 for military hardware codes.  
P - Jackpost  
K - Jackscrew-standard profile  
L - Jackscrew-low profile  
F - Float mount  
B - No hardware standard  
.091 (2.31) dia. hole for sizes 9-51;  
.120 (3.05) dia. hole for size 100.  
A - .125 (3.18) dia. mounting holes for sizes 9-51;  
.166 (4.22) dia. hole for size 100.  
B1 - .1475 (3.75) dia. hole for size 100  
(Per 83513-Style)

### TERMINATION CODE\*

(H) 001 - 18", 7/34 strand, #26 AWG,  
MIL-W-16878/4, Type E Teflon, yellow.  
(H) 003 - 18", 7/34 strand, #26 AWG,  
MIL-W-16878/4, Type E Teflon,  
color coded to MIL-STD-681 System I.  
(L) 1 - 1/2" uninsulated solid #25  
AWG gold plated copper.  
(L) 2 - 1" uninsulated solid #25 AWG  
gold plated copper.

### SHELL FINISH MOD CODES

No Number - (Standard cadmium/yellow  
chromate over nickel  
A174 - Electroless nickel  
A172 - Gold over nickel  
A141 - Irridite/alodine  
A30 - Black anodize

\*See page 79 and 81 for additional Termination codes.



COTS or Non Mil-Spec or Commercial or Industrial Standard Wire Termination Codes

Cannon Modification Code (Not MS)

The following termination codes are listed for your information. For additional codes please refer to Appendix on page 79 and 81. **All wire lengths are minimum.**

### Harness Type (H)

#26 AWG per MIL-W-16878/4, 7/34 strand, type E Teflon, stranded.

Length	All Yellow	Color Coded*
3 (76.2)	H020	H027
6 (152.4)	H019	H016
8 (203.2)	H026	H034
10 (254.0)	H029	H025
12 (304.8)	H028	H002
18 (457.2)	H001	H003
20 (508.0)	H038	H023
24 (609.6)	H009	H004
30 (762.0)	H010	H005
36 (914.4)	H011	H006
48 (1219.2)	H013	H048
72 (1828.8)	H017	H046
120 (3048.0)	H042	H041

\* Cavity #1 black

### Solid Uninsulated Type (L)

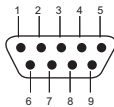
#25 AWG gold plated copper

Termination Code	Length
L61	.125 (3.18)
L56	.150 (3.81)
L57	.190 (4.83)
L39	.250 (6.35)
L58	.375 (9.52)
L1	.500 (12.70)
L14	.750 (19.05)
L2	1.000 (25.40)
L7	1.500 (38.10)
L6	2.000 (50.80)
L16	2.500 (63.50)
L10	3.000 (76.20)

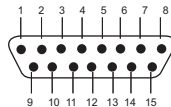
## Contact Arrangements

(Face View of Pin insert - Use Reverse Order for Socket Side)

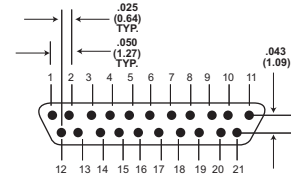
### Standard



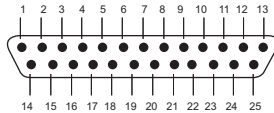
9 Contacts



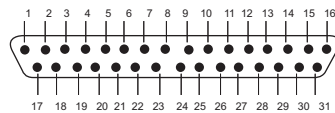
15 Contacts



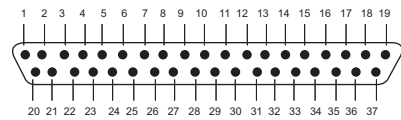
21 Contacts



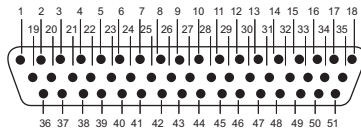
25 Contacts



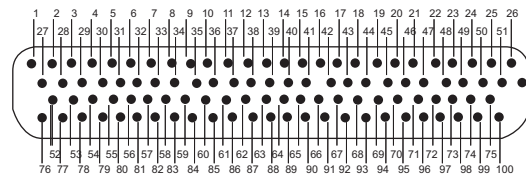
31 Contacts



37 Contacts

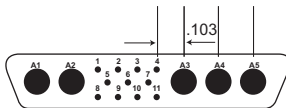


51 Contacts

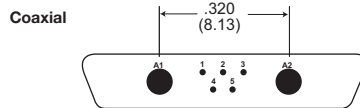


100 Contacts

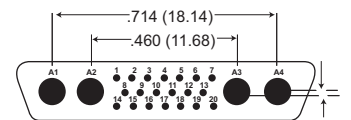
Contact identification numbers are for reference only and do not appear on insulator or connector body.



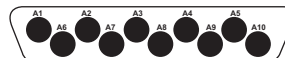
Size 51 Shell  
11 Micro contact  
5 Coax or 5 Power



Size 25 Shell  
5 Micro contact  
2 Coax or 2 Power



Size 51 Shell  
20 Micro contacts  
4 Coax or 4 Power  
(Not MS)



Size 100 Shell  
10 Micro contact  
10 Coax or 10 Power

Dimensions shown in inch (mm)

Specifications and dimensions subject to change

www.ittcannon.com

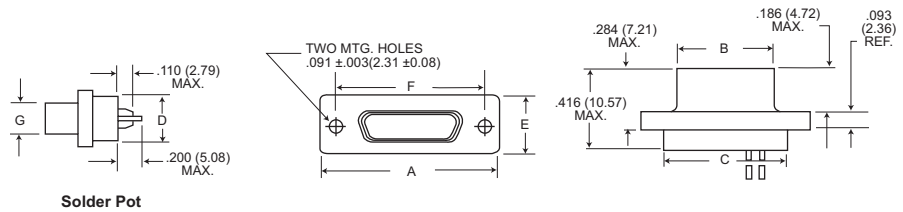


# Micro-D Metal Shell - .050" Contact Spacing

MDM

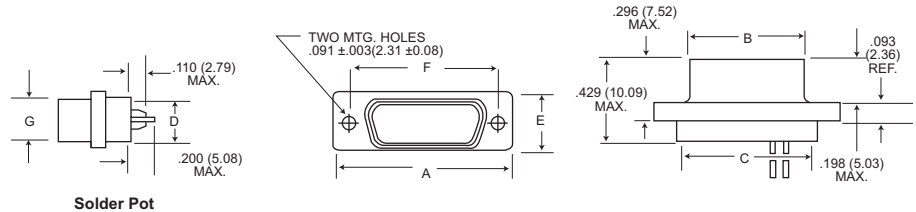
COTS or Non Mil-Spec or Commercial or Industrial Shell Dimensions (Conforms to 83513-Style)

## Plug



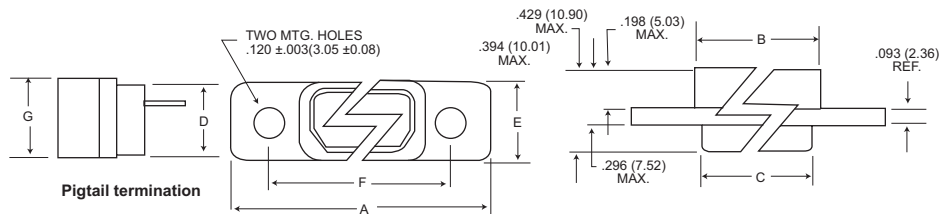
Solder Pot

## Receptacle



Solder Pot

## Receptacle (MDM-100 only)



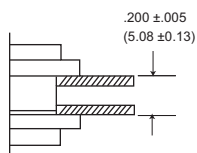
Pigtail termination

Part Number By Shell Size	A Max.	B Max.	C Max.	D Max.	E Max.	F + .005 (0.13)	G Max.	Average Weights** oz. (gm.) ±5%
MDM-9P*	.785 (19.94)	.334 (8.48)	.400 (10.16)	.270 (6.86)	.308 (7.82)	.565 (14.35)	.185 (4.70)	.063 (1.79)
MDM-9S*	.785 (19.94)	.402 (10.21)	.400 (10.16)	.270 (6.86)	.308 (7.82)	.565 (14.35)	.253 (6.43)	.063 (1.79)
MDM-15P*	.935 (23.75)	.484 (12.29)	.550 (13.97)	.270 (6.86)	.308 (7.82)	.715 (18.16)	.185 (4.70)	.084 (2.39)
MDM-15S*	.935 (23.75)	.552 (13.97)	.550 (13.97)	.270 (6.86)	.308 (7.82)	.715 (18.16)	.253 (6.43)	.083 (2.37)
MDM-21P*	1.085 (27.56)	.634 (16.10)	.700 (17.78)	.270 (6.86)	.308 (7.82)	.865 (21.97)	.185 (4.70)	.105 (2.99)
MDM-21P*	1.085 (27.56)	.702 (17.83)	.700 (17.78)	.270 (6.86)	.308 (7.82)	.865 (21.97)	.253 (6.43)	.104 (2.97)
MDM-25P*	1.185 (30.10)	.734 (18.64)	.800 (20.32)	.270 (6.86)	.308 (7.82)	.965 (24.51)	.185 (4.70)	.119 (3.39)
MDM-25S*	1.185 (30.10)	.802 (20.37)	.800 (20.32)	.270 (6.86)	.308 (7.82)	.965 (24.51)	.253 (6.43)	.118 (3.36)
MDM-31P*	1.335 (33.91)	.884 (22.45)	.950 (24.13)	.270 (6.86)	.308 (7.82)	1.115 (28.32)	.185 (4.70)	.140 (3.99)
MDM-31S*	1.335 (33.91)	.952 (24.18)	.950 (24.13)	.270 (6.86)	.308 (7.82)	1.115 (28.32)	.253 (6.43)	.139 (3.96)
MDM-37P*	1.485 (37.72)	1.034 (26.26)	1.100 (27.94)	.270 (6.86)	.308 (7.82)	1.265 (32.13)	.185 (4.70)	.161 (4.59)
MDM-37S*	1.485 (37.72)	1.102 (27.99)	1.100 (27.94)	.270 (6.86)	.308 (7.82)	1.265 (32.13)	.253 (6.43)	.160 (4.56)
MDM-51P*	1.435 (36.45)	.984 (24.99)	1.050 (26.67)	.310 (7.87)	.351 (8.92)	1.215 (30.86)	.228 (5.79)	.193 (5.50)
MDM-51S*	1.435 (36.45)	1.052 (26.72)	1.050 (26.67)	.310 (7.87)	.351 (8.92)	1.215 (30.86)	.296 (7.52)	.188 (5.35)
MDM-100P*	2.170 (55.12)	1.384 (35.15)	1.442 (36.63)	.360 (9.14)	.394 (10.01)	1.800 (45.72)	.271 (6.88)	.500 (14.3)
MDM-100S*	2.170 (55.12)	1.508 (38.10)	1.442 (36.63)	.360 (9.14)	.394 (10.01)	1.800 (45.72)	.394 (10.01)	1.040 (29.5)

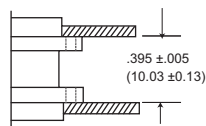
\*Add lead type and length; see How To Order.

\*\*\*Weight given is 1/2", insulated, solid, #25 AWG gold plated copper pigtails.

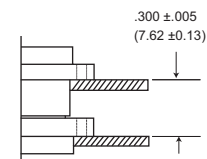
## Panel Mounting Dimensions (Sizes 9 - 100)



Plug and Receptacle  
Rear Mounted



Plug and Receptacle  
Front Mounted



Plug Front Mounted  
Receptacle Rear Mounted



Dimensions shown in inch (mm)  
Specifications and dimensions subject to change

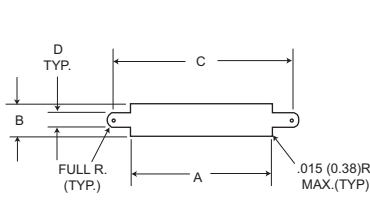
www.ittcannon.com



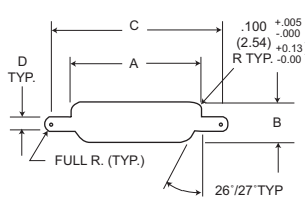
## Panel Cutouts

NOTE: See page 13 for rear panel mounting configuration.

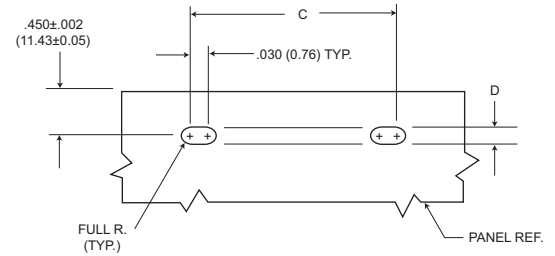
### Shell Sizes 9 thru 51



**Figure 1**  
Front Mounting

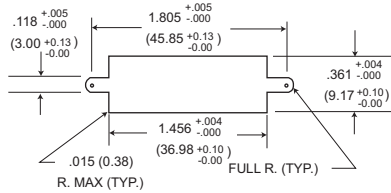


**Figure 2**  
Rear Mounting

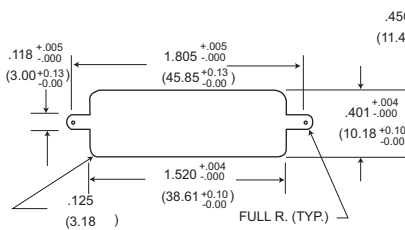


**Figure 3**  
Edgeboard Mounting

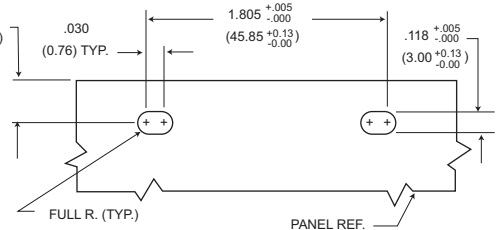
### Shell Size 100



**Figure 1**  
Front Mounting



**Figure 2**  
Rear Mounting



**Figure 3**  
Edgeboard Mounting

### For 9-51 Shell Sizes

#### NOTES:

1. Front panel mounting is the preferred mounting method. Front panel mounting dimensions (figure 1) will accommodate either #2-56 screws or jackpost hardware.
2. Rear panel mount dimensions (figure 2) will accommodate #2-56 screw hardware only. When mounting the connector with rear panel mount jackpost see the panel cut-out dimensions.
3. Edgeboard mounting bracket (figure 3) uses #2-56 screws. Dimension .450+/-0.002 (11.43+/-0.05) locates the MDM receptacle flush with the end of the board.

### For 100 Shell Size

#### NOTES:

1. Front mounting is the preferred mounting method. Front panel mounting dimensions (figure 1) will accommodate either #4-40 screws or jackpost hardware.
2. Rear panel mount dimensions (figure 2) will accommodate #4-40 screw hardware only see the panel cut-out dimensions.
3. Edgeboard mounting bracket (figure 3) uses #4-40 screws. Dimension .450+/-0.002 (11.43+/-0.05) locates the MDM receptacle flush with the end of the board.

Shell Size	Cutout Figure	A +.004 -.000	B +.004 -.000	C +.005 -.000	D +.005 -.000
9	1	.408	.271	.570	.089
	2	.401	.252	.570	.089
	3	-	-	.570	.089
15	1	.558	.271	.720	.089
	2	.551	.252	.720	.089
	3	-	-	.720	.089
21	1	.708	.271	.870	.089
	2	.701	.252	.870	.089
	3	-	-	.870	.089
25	1	.808	.271	.970	.089
	2	.801	.252	.970	.089
	3	-	-	.970	.089
31	1	.958	.271	1.120	.089
	2	.951	.252	1.120	.089
	3	-	-	1.120	.089
37	1	1.108	.271	1.270	.089
	2	1.101	.252	1.270	.089
	3	-	-	1.270	.089
51	1	1.058	.315	1.220	.089
	2	1.051	.295	1.220	.089
	3	-	-	1.220	.089

Dimensions shown in inch (mm)

Specifications and dimensions subject to change

www.ittcannon.com



## Mounting Hardware Views (for sizes 9-51)

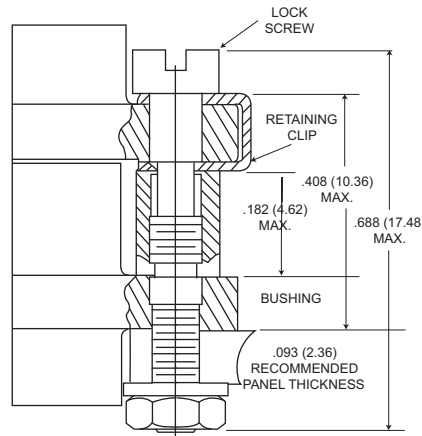
This hardware supplied unassembled.



**Screw Lock Assembly**

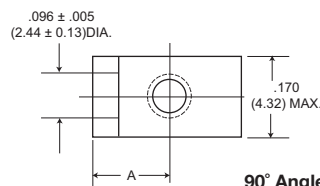


**90° Angle Mounting Bracket**

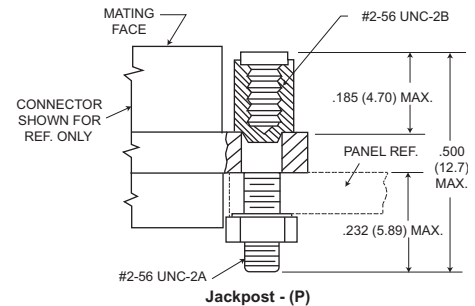


**Screw Lock Assembly\***

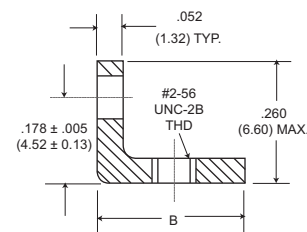
\*NOTE Torque value is 2.5 in/lbs max.



**90° Angle Mounting Bracket**



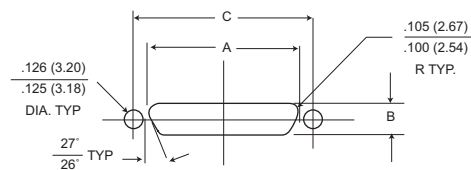
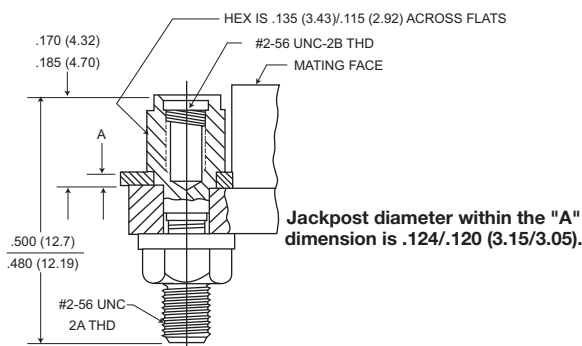
**Jackpost - (P)**



Description	Part Number	A	
		+/- .005 (±0.13)	B Max.
Screw Lock Assembly	322-9500-000		N/A
Jackpost kit	320-9505-000		N/A
Mounting Bracket 90° MDM for 9 thru 37 Shell Sizes	015-9516-002	.147 (3.73)	.308 (7.82)
Mounting Bracket 90° MDM for 51 Shell Size	015-9516-003	.169 (4.29)	.350 (8.89)

NOTES: Screw lock assembly (322-9500-000) can be used for front mounting only. Jackpost kit (320-9505-000) consists of two assemblies, shipped unassembled.

## Jackpost Bushing (for rear panel mounting-for sizes 9-51)



### Plug and Receptacle Dimensions

Shell Size	A		B	C
	+ .004 (0.10) - .000 (0.00)	+ .004 (0.10) - .000 (0.00)	+ .004 (0.10) - .000 (0.00)	± .005 (0.13)
9	.401 (10.19)	.252 (6.40)	.565 (14.35)	
15	.551 (14.00)	.252 (6.40)	.715 (18.16)	
21	.701 (17.81)	.252 (6.40)	.865 (21.97)	
25	.801 (20.34)	.252 (6.40)	.965 (24.51)	
31	.951 (24.16)	.252 (6.40)	1.115 (28.34)	
37	1.101 (27.97)	.252 (6.40)	1.265 (32.13)	
51	1.051 (26.70)	.295 (7.49)	1.215 (30.86)	

Panel A Thickness	A + .005 (0.13) - .000 (0.00)	Jackpost Kit Number*
3/32 (2.4)	.087 (2.21)	320-9505-007
1/16 (1.6)	.056 (1.42)	320-9505-006
3/64 (1.2)	.042 (1.07)	320-9505-005
1/32 (0.8)	.025 (0.64)	320-9505-004

\*A kit consists of 2 jackpost, 2 nuts, 2 washers.

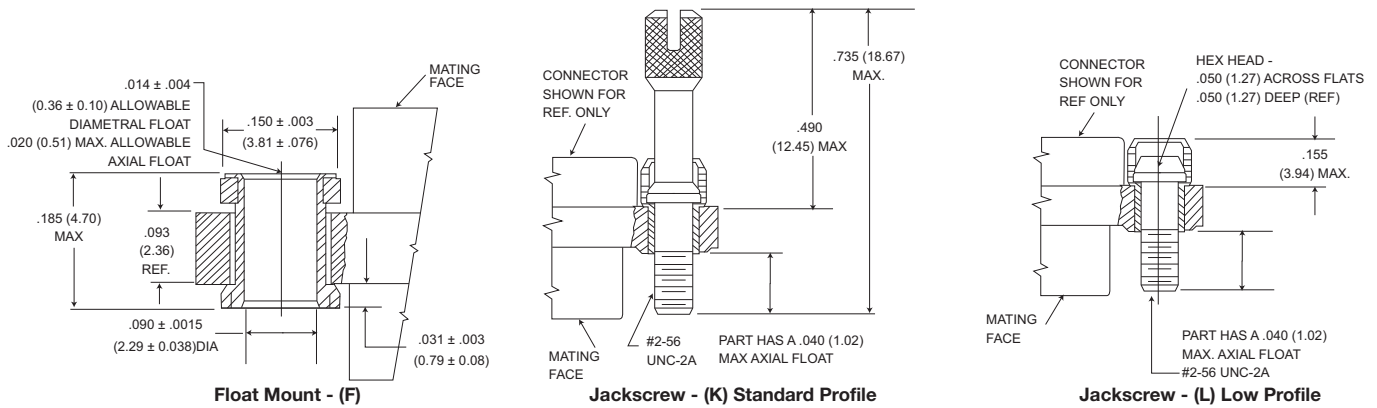


Dimensions shown in inch (mm)  
Specifications and dimensions subject to change

www.ittcannon.com

## Mounting Hardware Views (sizes 9-51)

This hardware is factory installed.

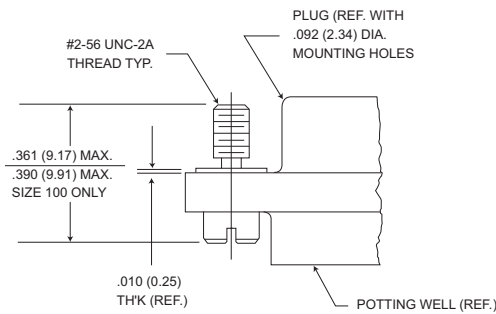


Shown here is a cutaway view of the float mount for the MDM connector. The basic shell dimensions are the same for the float mount and the screw mounting hole configurations. View shown is for standard float mount front panel mounting. Reverse mounting is available on request.

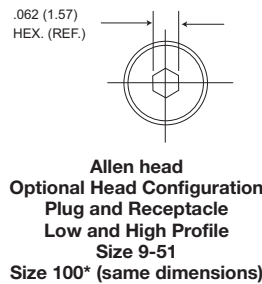
\* NOTE: Torque values are as follows:  
 Low Profile Jackscrew (L)-2.5 in-lbs  
 Standard Jackscrew (K)-2.5 in-lbs

## Mounting Hardware to Military Specification (for sizes 9 - 100) per 83513/5-Style

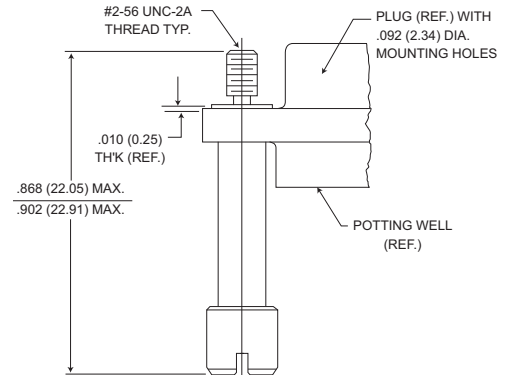
This hardware supplied in kits unassembled (2 pieces of each item).



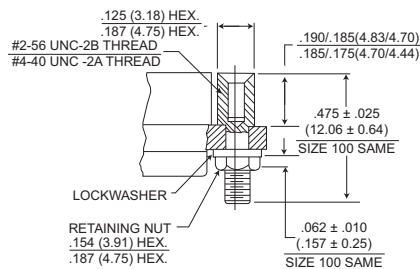
**Figure 1. Jackscrew - Low profile Slotted Head Size 9-51 Size 100\***



**Allen head Optional Head Configuration Plug and Receptacle Low and High Profile Size 9-51 Size 100\* (same dimensions)**



**Figure 2. Jackscrew - High Profile Slotted Head Size 9-51 Size 100\***



**Figure 3. Jackpost Assembly Size 9-51 Size 100\***

To order hardware kits separately, order either by M83513/5-Style\*\* or by 320-950X-XXX.

Description	Size 9-51		Size 100*	
	Mod Code	Part Number	Mod Code	Part Number
Slotted Head Jackscrew Assy Low Profile (Figure 1)	M5	320-9508-025	05	M15 320-9508-021
Slotted Head Jackscrew Assy Low Profile (Figure 2)	M6	320-9508-027	06	M16 320-9508-023
Allen Head Jackscrew Assy Low Profile (Figure 1)	M2	320-9508-026	02	M12 320-9508-022
Allen Head Jackscrew Assy High Profile (Figure 2)	M3	320-9508-028	03	M13 320-9508-024
Jackpost Assy (Figure 3)	M7	320-9505-033	07	M17 320-9505-030

\*Size 100 requires B1 size mounting holes for Mil-Spec hardware

Note: Torque values as follows:

- Size 9-51 4.0 in-lbs
- Size 100 6.0 in-lbs

Dimensions shown in inch (mm)

Specifications and dimensions subject to change

www.ittcannon.com





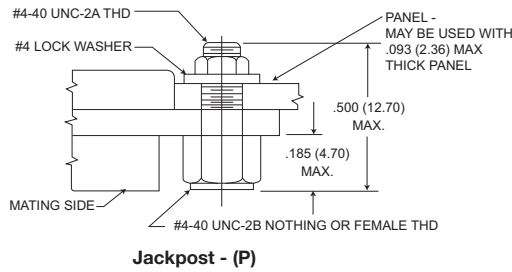
## Mounting Hardware Views (for size 100)

This hardware supplied unassembled.

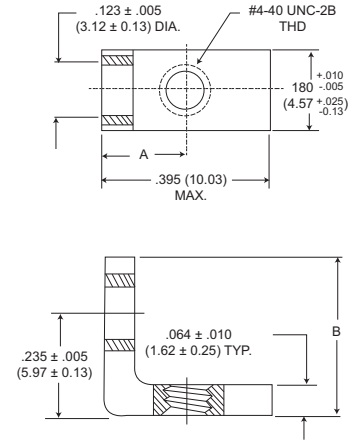


**90° Angle Mounting Bracket**

Note: Size 100 requires .120 dia (B) mounting hole when using Commercial (P) jackpost kits.



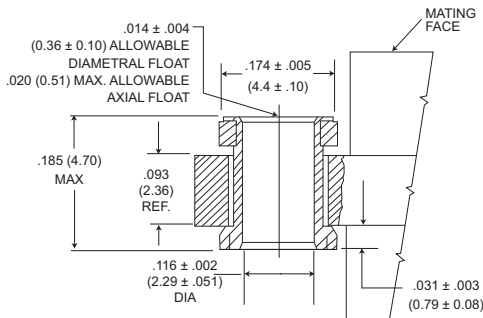
**Jackpost - (P)**



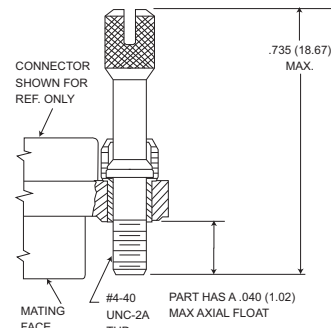
**90° Angle Mounting Bracket**

Description	Part Number	A ± .005 (0.13)	B Max.
Jackpost kit	320-9505-015	N/A	
Mounting Bracket 90° MDM	015-9528-000	.191 (4.85)	.370 (9.40)

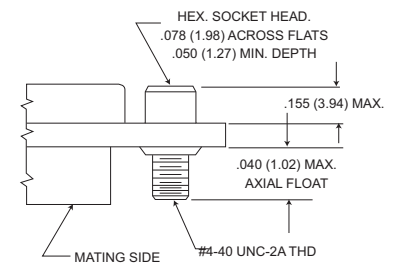
This hardware is factory installed.



**Float Mount - (F) Std.**



**Jackscrew - (K) Standard**



**Jackscrew - (L) (Low Profile)**

\*NOTE: Torque values are as follows:  
Low Profile Jackscrew (L)-4.0 in-lbs  
Standard Profile Jackscrew (K)-4.0 in-lbs

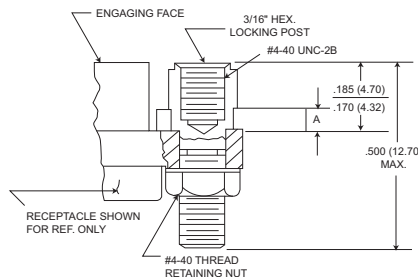
## Jackpost Bushing (for Rear Panel Mounting)

Panel Thickness	A + .005 (0.13) - .000 (0.00)	Jackpost Kit Number*
3/32 (2.4)	.087 (2.21)	320-9505-013
1/16 (1.6)	.058 (1.42)	320-9505-012
1/32 (0.8)	.025 (0.64)	320-9505-010
3/64 (1.2)	.042 (1.07)	320-9505-011

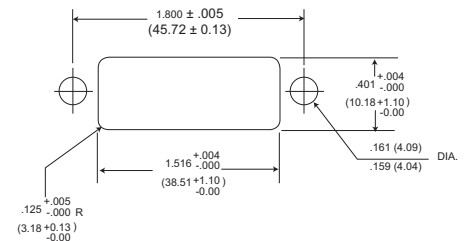
\*2 jackposts, 2 nuts, 2 washers

Torque value for size 100

Note: Size 100 requires B mounting hole shell size when using rear panel mount jackposts



### Dimensions for Rear Panel Mounting



Dimensions shown in inch (mm)  
Specifications and dimensions subject to change

www.ittcannon.com

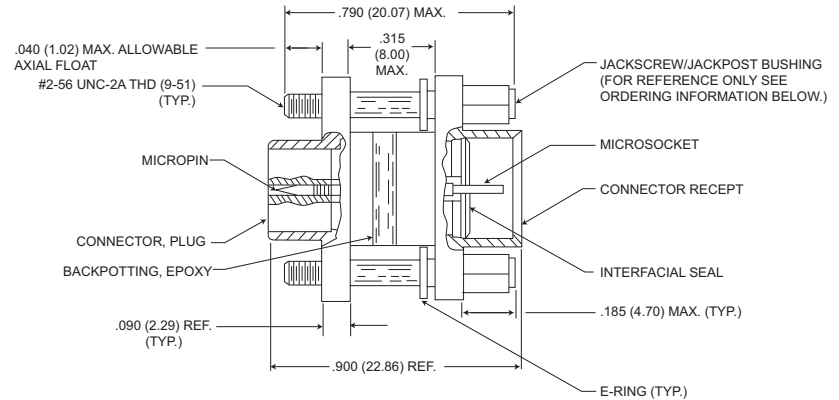
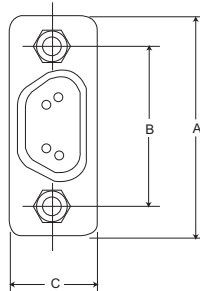
## Connector Saver



Save wear and tear on your equipment and systems connectors by using the "Connector Saver".

The multi-matings and unmatings experienced by most connectors during testing and final check out can be eliminated.

Simply mate the "Connectors Saver" to your unit and use the opposite side for your testing interface...less wear, less tear, less chance of damage. It is available in all eight standard MDM layouts. Mating hardware is available and can be ordered either separately or included with the connector saver.



MDM Size 9 Shown

Size	Electroless Nickel (A174) Plated		Cadmium over Nickel (A101) Plated		*Hardware Kits	A Max.	B ± .005 (0.13)	C Max.
	With Hardware	W/O Hardware	With Hardware	W/O Hardware				
9	MDM98479-86	MDM98479-18	MDM98479-78	MDM-97294-371	320-9505-014**	.785 (19.94)	.565 (14.35)	.308 (7.82)
15	MDM98479-87	MDM98479-19	MDM98479-79	MDM-97294-372	320-9505-014**	.935 (23.75)	.715 (18.16)	.308 (7.82)
21	MDM98479-88	MDM98479-20	MDM98479-80	MDM-97294-373	320-9505-014**	1.085 (27.56)	.865 (21.97)	.308 (7.82)
25	MDM98479-89	MDM98479-21	MDM98479-81	MDM-97294-374	320-9505-014**	1.185 (30.10)	.965 (24.51)	.308 (7.82)
31	MDM98479-90	MDM98479-14	MDM98479-82	MDM-97294-375	320-9505-014**	1.335 (33.91)	1.115 (28.32)	.308 (7.82)
37	MDM98479-91	MDM98479-15	MDM98479-83	MDM-97294-376	320-9505-014**	1.485 (37.72)	1.265 (32.13)	.308 (7.82)
51	MDM98479-92	MDM98479-16	MDM98479-84	MDM-97294-377	320-9505-014**	1.435 (36.45)	1.215 (30.86)	.351 (8.91)
100	MDM98479-93	MDM98479-17	MDM98479-85	MDM-97294-717	320-9508-014***	2.170 (55.12)	1.800 (45.72)	.394 (10.01)

\* Kit contains 2 jackpost/jackscrew bushings and 2 E-Rings.

\*\* Size 9-51-#2-56 UNC-2B Thread

\*\*\* Size 100-#4-40 UNC-2B Thread

M83513/ 01 - H100 - \*\* \*\*\*\*

### SERIES

- MDM - Metal Shell, Liquid Crystal Polymer (LCP)
- MDB - Diallyl Phthalate Insulator
- MDVB - Polyester Insulator
- 

### 83513-Style SLASH SHEET

- |  |                       |
|--|-----------------------|
| 01 - Plug, Connector, Solderpot        | } Metal Shell         |
| 02 - Receptacle, Connector, Solderpot  |                       |
| 03 - Plug, Connector, Crimp Type       |                       |
| 04 - Receptacle, Connector, Crimp Type |                       |
| 05 - Hardware Only $\triangle$         | } Plastic $\triangle$ |
| 06 - Plug, Connector, Solderpot        |                       |
| 07 - Receptacle, Connector, Solderpot  |                       |
| 08 - Plug, Connector, Crimp Type       |                       |
| 09 - Receptacle, Connector, Crimp Type |                       |

### INSERT ARRANGEMENT

	<u>METAL SHELL</u>	<u>PLASTIC</u>
A -	9 Contact	9 Contact
B -	15 Contact	15 Contact
C -	21 Contact	21 Contact
D -	25 Contact	25 Contact
E -	31 Contact	31 Contact
F -	37 Contact	37 Contact
G -	51 Contact	51 Contact
H -	100 Contact	$\triangle$

### WIRE TYPE

- No Number - For Solderpot
- 01 - 18" long, #26 AWG per MIL-W-22759/11-26-9 (all white)
  - 02 - 36" long, #26 AWG per MIL-W-22759/11-26-9 (all white)
  - 03 - 18" long, #26 AWG per MIL-W-22759/11-26  
Color Coded per MIL-STD-681, System 1, 10 colors repeating  $\triangle$
  - 04 - 36" long, #26 AWG per MIL-W-22759/11-26-  
Color Coded per MIL-STD-681, System 1, 10 colors repeating  $\triangle$
  - 05 - .5" long, #25 AWG, type S per QQ-W-343,  
Gold Plated
  - 06 - 1.0" long, #25 AWG, type S per QQ-W-343,  
Gold Plated
  - 07 - .5" long, #25 AWG, type S per QQ-W-W-343,  
Tin Plated
  - 08 - 1.0" long, #25 AWG, type S per QQ-W-343,  
Tin Plated
  - 09 - 18" long, #26 AWG per MIL-W-22759/33-26-9 (all white)  $\triangle$
  - 10 - 36" long, #26 AWG per MIL-W-22759/33-26-9 (all white)  $\triangle$
  - 11 - 18" long, #26 AWG per MIL-W-22759/33-26  
Color Coded per MIL-STD-681, System 1, 10 colors repeating  $\triangle$   $\triangle$
  - 12 - 36" long, #26 AWG per MIL-W-22759/33-26  
Color Coded per MIL-STD-681, System 1, 10 colors repeating  $\triangle$   $\triangle$
  - 13 - 72" long, #26 AWG per MIL-W-22759/11-26-9 (all white)  $\triangle$   $\triangle$
  - 14 - 72" long, #26 AWG per MIL-W-22759/11-26  
Color Coded per MIL-STD-681, System 1, 10 colors repeating  $\triangle$
  - 15 - 72" long, #26 AWG per MIL-W-22759/33-26-9 (all white)  $\triangle$
  - 16 - 72" long, #26 AWG per MIL-W-22759/33-26  
Color Coded per MIL-STD-681, System 1, 10 colors repeating  $\triangle$   $\triangle$

### NOTES:

- <sup>1</sup> - For every Mil Spec Part Number, ITT has one corresponding part number shown an example
- $\triangle$  - Tolerance on wire lengths: 18", 36" and 72" long – +1.00"/-0.00"  
.5" and 1.00" – +.200"/-.000"
- $\triangle$  - For space application, connector shell finish must be "A174" and wire must be per MIL-W-22759/33-26.
- 4 - Any deviations to these P/N's will result in assignment of a special P/N, consult factory.
- $\triangle$  - Size 100 not available in / 06 through / 09. (Plastic shell)
- $\triangle$  - Color coding in accordance with MIL-STD-681, System 1, no parenthesis. See page 83 for color code chart.
- $\triangle$  - For mounting hardware to Military Specification (sizes 9 to 100) see page 13.

### SHELL FINISH

- No number - for plastic type connector
- C – for Cadmium/Yellow chromate over nickel
- N – A174 - Electroless Nickel A174  $\triangle$





M83513/ 10 - A \*\* C \*

**SERIES**

Connector, Electrical, Rectangular  
 Microminiature, Polarized Shell  
 PC Board Mounting

**MIL-C-83513 SLASH SHEET**


- 10 - Connector, Plug, Condensed Board Right Angle (CBR), Sizes 9 – 37
- 11 - Connector, Plug, CBR, Size 51
- 12 - Connector, Plug, CBR, Size 100
- 13 - Connector, Receptacle, CBR, Sizes 9 – 37
- 14 - Connector, Receptacle, CBR Size 51
- 15 - Connector, Receptacle, CBR, Size 100
- 16 - Connector, Plug, Board Right Angle (BR), Sizes 9 – 37
- 17 - Connector, Plug, BR, Size 51
- 18 - Connector, Plug, BR, Size 100
- 19 - Connector, Receptacle, BR, Sizes 9 – 37
- 20 - Connector, Receptacle, BR Size 51
- 21 - Connector, Receptacle, BR Size 100
- 22 - Connector, Plug, Board Straight (BS), Sizes 9 – 37
- 23 - Connector, Plug, BS, Size 51
- 24 - Connector, Plug, BS, Size 100
- 25 - Connector, Receptacle, BS, Sizes 9 – 37
- 26 - Connector, Receptacle, BS, Size 51
- 27 - Connector, Receptacle, BS Size 100

**INSERT ARRANGEMENT**



METAL SHELL

- A - 9 Contact
- B - 15 Contact
- C - 21 Contact
- D - 25 Contact
- E - 31 Contact
- F - 37 Contact
- G - 51 Contact
- H - 100 Contact



**WIRE TYPE**

- No Number - For Solderpot
- 01 - .109" long, #24 AWG solid copper wire per QQ-W-343, Type "S", solder dipped
- 02 - .140" long, #24 AWG solid copper wire per QQ-W-343, Type "S", solder dipped 
- 03 - .172" long, #24 AWG solid copper wire per QQ-W-343, Type "S", solder dipped

**NOTES:**

- 1 - For every Mil Spec Part Number, ITT has one corresponding part number
-  - Tolerance on wire lengths ±.015
-  - For space application, connector shell finish must be "N".
- 4 - Any deviations to these P/N's will result in assignment of a special P/N, consult customer service.

**SHELL FINISH**

- No letter - for plastic type connector
- C - Cadmium / Yellow chromate over nickel
- N - Electroless Nickel  

**HARDWARE**

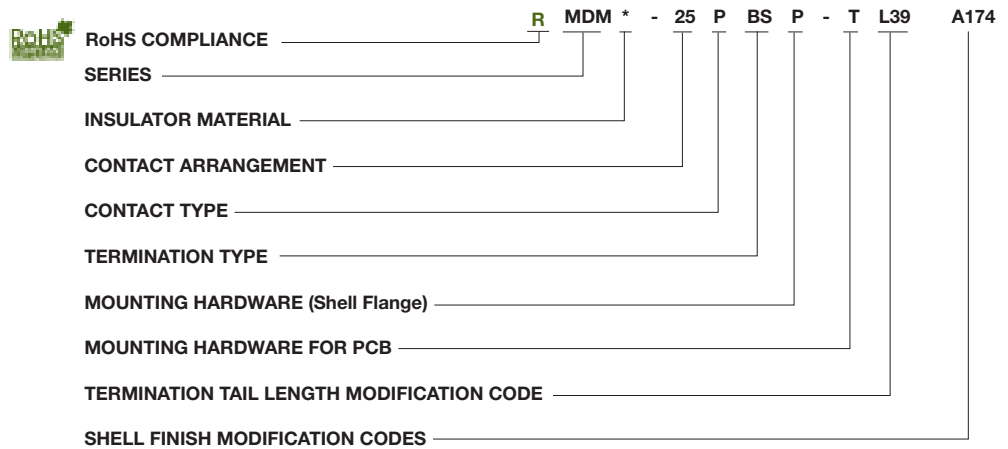
- N - No jackpost
- P - Jackpost (permanently attached)
- T - Threaded insert



MDM-PCB connectors are designed for use with flex circuitry, flat cable and printed circuit boards or multi-layer boards. They use the standard MDM metal shell and provide high density and high reliability in board-to-board, board-to-cable and cable-to-cable applications.

MDM-PCB connectors are available in 8 shell sizes with 9 to 100 contacts. Terminations may be straight (BS) or at 90° right angle (BR, CBR) board thickness. Jackpost mounting for use with locking hardware is also available.

## How to Order - MDM-PCB Series



- SERIES**  
MDM - Micro "D" Metal Shell
- INSULATOR MATERIAL**  
Liquid Crystal Polymer (LCP)
- CONTACT ARRANGEMENT**  
9, 15, 21, 25, 31, 37, 51, and 100
- CONTACT TYPE**  
P - Pin (Plug)  
S - Socket (Receptacle)

- TERMINATION TYPE**  
BS - Straight PCB Termination  
BR - Right Angle PCB Termination  
CBR - Right Angle Narrow Profile PCB Terminations
- MOUNTING HARDWARE (Shell Flange)**  
P - Jackposts  
M7 - Jackposts  
M83513/5-07 (Sizes 9-51)  
M17 - Jackposts  
M83513/5-17 (Size 100)  
No letter - none

- MOUNTING HARDWARE FOR PCB**  
T - Threaded Insert  
#2-56 Thd for Shell Sizes 9 thru 51  
#4-40 Thd for Shell Size 100  
No letter - none

- TERMINATION TAIL LENGTH MODIFICATION CODE**  
None - .109 (2.77) ±.015 (0.38) Standard  
L61 - .125 (3.18)  
L56 - .150 (3.81)  
L57 - .190 (4.83)  
L39 - .250 (6.35)  
L58 - .375 (9.52)

- SHELL FINISH MODIFICATION CODES**  
None - Yellow Chromate/Cadmium over Nickel  
A174 - Electroless Nickel  
A172 - Gold over Nickel  
A141 - Iridite/Alodine  
A30 - Black Anodize  
(For special modification codes, consult customer service.)

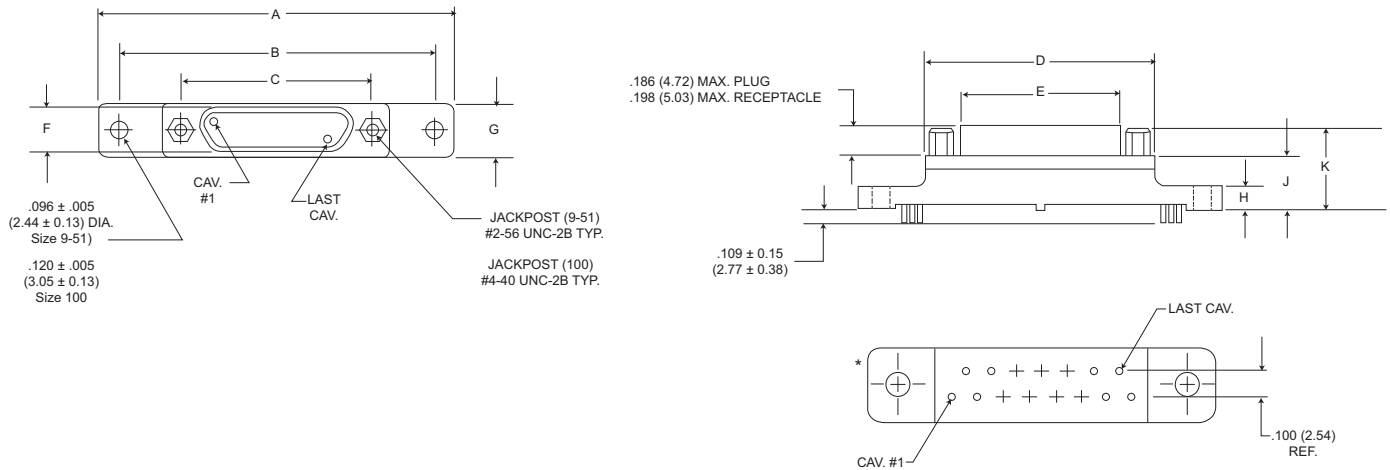
NOTE: Back molding material – Epoxy Hysol #MG40FS



Dimensions shown in inch (mm)  
Specifications and dimensions subject to change

www.ittcannon.com

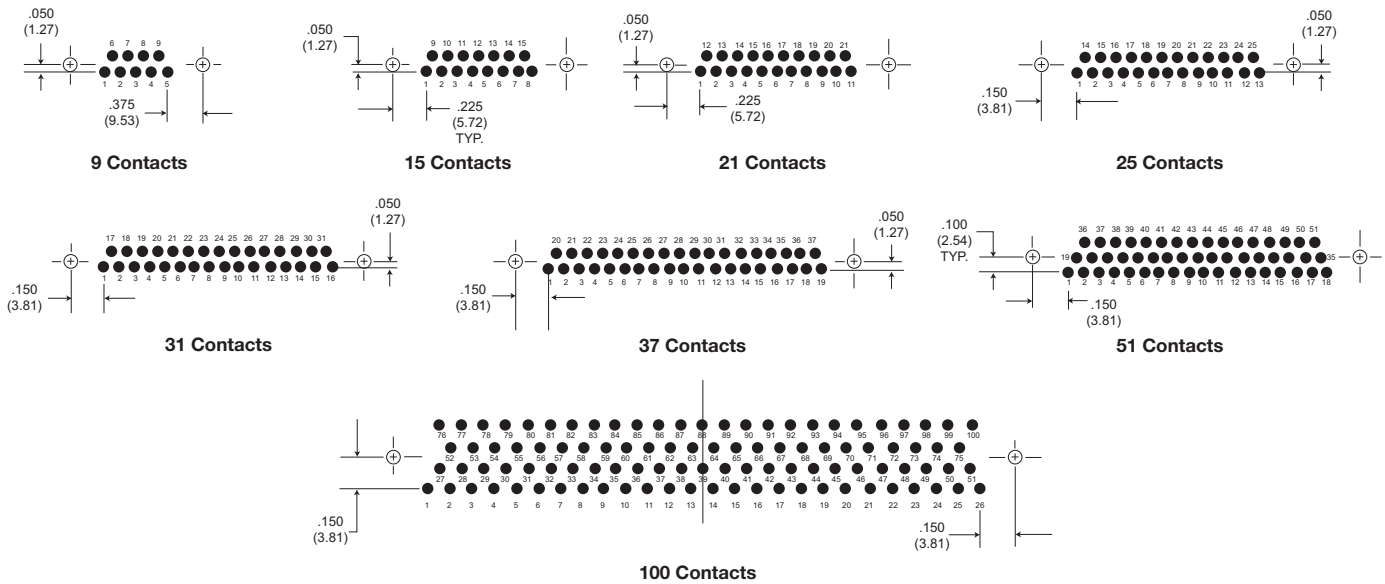
## BS (Board Straight) Series



### PCB Termination Arrangements\* (Viewed from PCB solder side)

Identification number shown for plug connector, use reverse order for socket connector.

NOTE: Dimensions shown are for reference only-consult factory for final design dimensions.



NOTE: Standard lead termination is #24 AWG, solid copper, solder or tin dipped

All Termination Configurations .100 (2.54) x .100 (2.54) Grid Pattern, Offset .050 (1.27)

Part Number By Shell Size	A Max.	B ±.007 (.18)	C ±.005 (.13)	D Max.	E Max.	F Max.	G Max.	H Max.	J Max.	K Max.
MDM-9PBS*	1.390 (35.31)	1.150 (29.21)	.565 (14.35)	.785 (19.94)	.334 (8.48)	.185 (4.70)	.308 (7.82)	.165 (4.19)	.355 (9.02)	.555 (14.10)
MDM-9SBS*	1.390 (35.31)	1.150 (29.21)	.565 (14.35)	.785 (19.94)	.402 (10.21)	.253 (6.43)	.308 (7.82)	.165 (4.19)	.355 (9.02)	.555 (14.10)
MDM-15PBS*	1.390 (35.31)	1.150 (29.21)	.715 (18.16)	.935 (23.75)	.484 (12.29)	.185 (4.70)	.308 (7.82)	.165 (4.19)	.355 (9.02)	.555 (14.10)
MDM-15SBS*	1.390 (35.31)	1.150 (29.21)	.715 (18.16)	.935 (23.75)	.552 (13.97)	.253 (6.43)	.308 (7.82)	.165 (4.19)	.355 (9.02)	.555 (14.10)
MDM-21PBS*	1.690 (43.93)	1.450 (36.83)	.865 (21.97)	1.085 (27.56)	.634 (16.10)	.185 (4.70)	.308 (7.82)	.165 (4.19)	.355 (9.02)	.555 (14.10)
MDM-21SBS*	1.690 (43.93)	1.450 (36.83)	.865 (21.97)	1.085 (27.56)	.702 (17.83)	.253 (6.43)	.308 (7.82)	.165 (4.19)	.355 (9.02)	.555 (14.10)
MDM-25PBS	1.740 (44.20)	1.500 (38.10)	.965 (24.51)	1.185 (30.10)	.734 (18.64)	.185 (4.70)	.308 (7.82)	.165 (4.19)	.355 (9.02)	.555 (14.10)
MDM-25SBS*	1.740 (44.20)	1.500 (38.10)	.965 (24.51)	1.185 (30.10)	.802 (20.37)	.253 (6.43)	.308 (7.82)	.165 (4.19)	.355 (9.02)	.555 (14.10)
MDM-31PBS*	2.040 (51.82)	1.800 (45.72)	1.115 (28.32)	1.335 (33.91)	.884 (22.45)	.185 (4.70)	.308 (7.82)	.165 (4.19)	.355 (9.02)	.555 (14.10)
MDM-31SBS*	2.040 (51.82)	1.800 (45.72)	1.115 (28.32)	1.335 (33.91)	.952 (24.18)	.253 (6.43)	.308 (7.82)	.165 (4.19)	.355 (9.02)	.555 (14.10)
MDM-37PBS*	2.340 (59.44)	2.100 (53.34)	1.265 (32.13)	1.485 (37.72)	1.034 (26.26)	.185 (4.70)	.308 (7.82)	.165 (4.19)	.355 (9.02)	.555 (14.10)
MDM-37SBS*	2.340 (59.44)	2.100 (53.34)	1.265 (32.13)	1.485 (37.72)	1.102 (27.99)	.253 (6.43)	.308 (7.82)	.165 (4.19)	.355 (9.02)	.555 (14.10)
MDM-51PBS*	2.270 (67.66)	2.000 (50.80)	1.215 (30.86)	1.435 (36.45)	.984 (24.99)	.228 (5.79)	.351 (8.92)	.165 (4.19)	.355 (9.02)	.555 (14.10)
MDM-51SBS*	2.270 (67.66)	2.000 (50.80)	1.215 (30.86)	1.435 (36.45)	1.052 (26.72)	.296 (7.52)	.351 (8.92)	.165 (4.19)	.355 (9.02)	.555 (14.10)
MDM-100PBS*	3.070 (77.98)	2.800 (71.12)	1.800 (45.72)	2.175 (55.24)	1.384 (35.15)	.271 (6.88)	.460 (11.68)	.303 (7.70)	.550 (12.70)	.686 (17.42)
MDM-100SBS*	3.070 (77.98)	2.800 (71.12)	1.800 (45.72)	2.175 (55.24)	1.508 (38.30)	.394 (10.01)	.460 (11.68)	.303 (7.70)	.550 (12.70)	.686 (17.75)

\*For jackpost, add letter "P" or "M7" for sizes 9-51, "M17" for size 100.

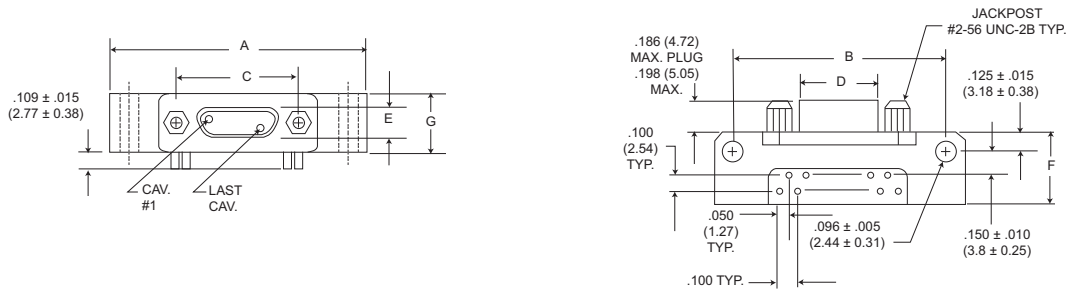
Dimensions shown in inch (mm)

Specifications and dimensions subject to change

www.ittcannon.com

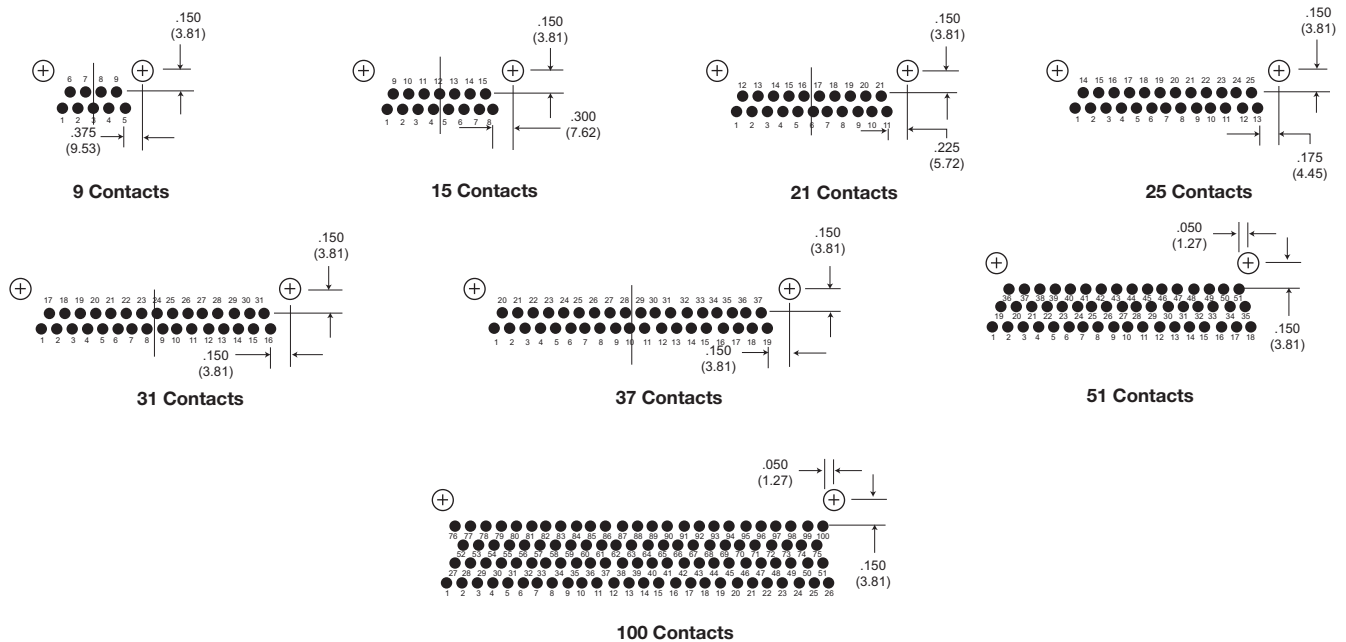


## BR (Board Right Angle) Series



### PCB Termination Arrangements (Viewed from bottom of connector, PCB solder side.)

Identification number shown for plug connector, use reverse order for socket connector.



NOTE: Standard lead termination is #24 AWG, gold plated, solid copper, solder or tin dripped.

All Termination Configurations .100 (2.54) x .100 (2.54) Grid Pattern, Offset .050 (1.27).

Part Number By Shell Size	A Max.	B ± .007 (.18)	C ± .005 (.13)	D Max.	E Max.	F Max.	G Max.
MDM-9PBR*	1.390 (35.31)	1.150 (29.21)	.565 (14.35)	.334 (8.48)	.185 (4.70)	.455 (11.56)	.308 (7.82)
MDM-9SBR*	1.390 (35.31)	1.150 (29.21)	.565 (14.35)	.402 (10.21)	.253 (6.43)	.455 (11.56)	.308 (7.82)
MDM-15PBR*	1.540 (39.12)	1.300 (33.02)	.715 (18.16)	.484 (12.29)	.185 (4.70)	.455 (11.56)	.308 (7.82)
MDM-15SBR*	1.540 (39.12)	1.300 (33.02)	.715 (18.16)	.552 (13.97)	.253 (6.43)	.455 (11.56)	.308 (7.82)
MDM-21PBR*	1.690 (42.93)	1.450 (36.83)	.865 (21.97)	.634 (16.10)	.185 (4.70)	.455 (11.56)	.308 (7.82)
MDM-21SBR*	1.690 (42.93)	1.450 (36.83)	.865 (21.97)	.702 (17.83)	.253 (6.43)	.455 (11.56)	.308 (7.82)
MDM-25PBR*	1.790 (45.47)	1.550 (39.37)	.965 (24.51)	.734 (18.64)	.185 (4.70)	.455 (11.56)	.308 (7.82)
MDM-25SBR*	1.790 (45.47)	1.550 (39.37)	.965 (24.51)	.802 (20.37)	.253 (6.43)	.455 (11.56)	.308 (7.82)
MDM-31PBR*	2.040 (51.82)	1.800 (45.72)	1.115 (28.32)	.884 (22.45)	.185 (4.70)	.455 (11.56)	.308 (7.82)
MDM-31SBR*	2.040 (51.82)	1.800 (45.72)	1.115 (28.32)	.952 (24.18)	.253 (6.43)	.455 (11.56)	.308 (7.82)
MDM-37PBR*	2.340 (59.44)	2.100 (53.34)	1.265 (32.13)	1.034 (26.26)	.185 (4.70)	.455 (11.56)	.308 (7.82)
MDM-37SBR*	2.340 (59.44)	2.100 (53.34)	1.265 (32.13)	1.102 (27.99)	.253 (6.43)	.455 (11.56)	.308 (7.82)
MDM-51PBR*	1.875 (47.63)	1.600 (40.64)	1.215 (30.86)	.984 (24.99)	.228 (5.79)	.565 (14.35)	.351 (8.92)
MDM-51SBR*	1.875 (47.63)	1.600 (40.64)	1.215 (30.86)	1.052 (26.72)	.296 (7.52)	.565 (14.35)	.351 (8.92)
MDM-100PBR*	2.74 (69.72)	2.500 (63.50)	1.800 (45.72)	1.384 (35.15)	.271 (6.88)	.755 (19.18)	.394 (10.01)
MDM-100SBR*	2.74 (69.72)	2.500 (63.50)	1.800 (45.72)	1.508 (38.10)	.394 (10.01)	.755 (19.18)	.394 (10.01)

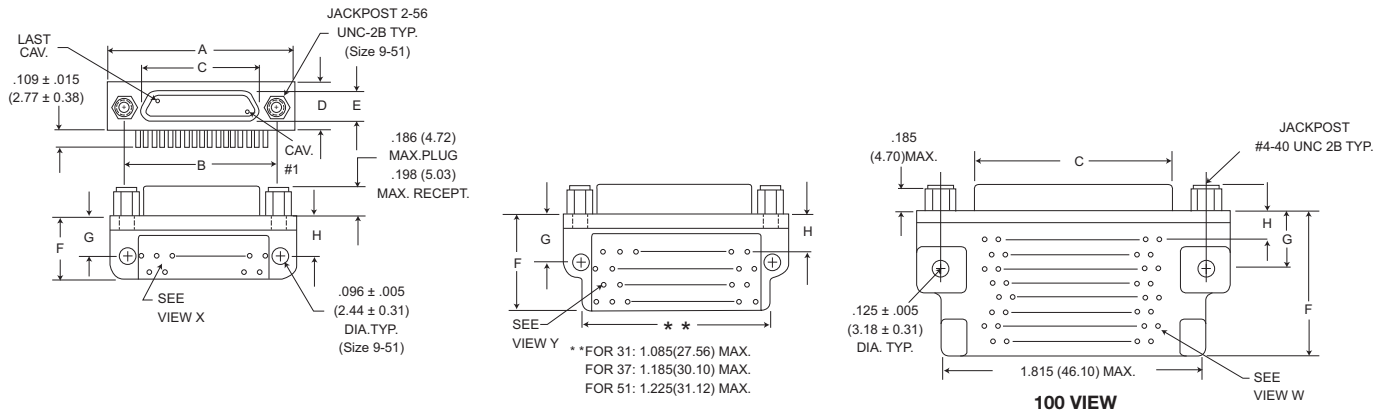
\*For jackpost, add letter "P" or "M7" for sizes 9-51, "M17" for size 100.



Dimensions shown in inch (mm)  
Specifications and dimensions subject to change

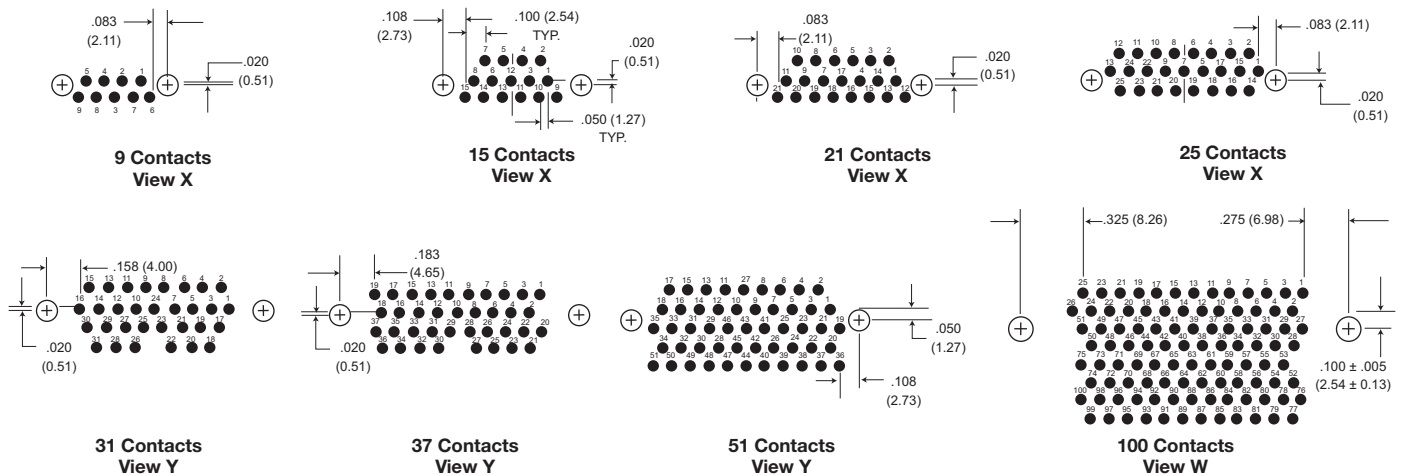
www.ittcannon.com

## CBR (Condensed Board Right Angle) Series



### PCB Termination Arrangements (Viewed from bottom of connector, PCB solder side.)

Identification number shown for plug connector, use reverse order for socket connector.



All Termination Configurations .100 (2.54) x .100 (2.54) Grid Pattern, Offset .050 (1.27).

NOTE: Standard lead termination is #24 AWG, solid copper, solder or tin dripped.

Part Number By Shell Size	A Max.	B ± .005 (.13)	C Max.	D Max.	E Max.	F Max.	G ± .010 (.25)	H ± .010 (.25)
MDM-9PCBR*	.785 (19.94)	.565 (14.35)	.334 (8.48)	.308 (7.82)	.185 (4.70)	.420 (10.67)	.250 (6.35)	.230 (5.81)
MDM-9SCBR*	.785 (19.94)	.565 (14.35)	.402 (10.21)	.308 (7.82)	.253 (6.43)	.420 (10.67)	.250 (6.35)	.230 (5.81)
MDM-15PCBR*	.935 (23.75)	.715 (18.16)	.484 (12.29)	.308 (7.82)	.185 (4.70)	.420 (10.67)	.250 (6.35)	.130 (3.30)
MDM-15SCBR*	.935 (23.75)	.715 (18.16)	.552 (13.97)	.308 (7.82)	.253 (6.43)	.420 (10.67)	.250 (6.35)	.130 (3.30)
MDM-21PCBR*	1.085 (27.56)	.865 (21.97)	.634 (16.10)	.308 (7.82)	.185 (4.70)	.420 (10.67)	.250 (6.35)	.130 (3.30)
MDM-21SCBR*	1.085 (27.56)	.865 (21.97)	.702 (17.83)	.308 (7.82)	.253 (6.43)	.420 (10.67)	.250 (6.35)	.130 (3.30)
MDM-25PCBR*	1.185 (30.10)	.965 (24.51)	.734 (18.64)	.308 (7.82)	.184 (4.70)	.420 (10.67)	.250 (6.35)	.130 (3.30)
MDM-25SCBR*	1.185 (30.10)	.965 (24.51)	.802 (20.37)	.308 (7.82)	.253 (6.43)	.420 (10.67)	.250 (6.35)	.130 (3.30)
MDM-31PCBR*	1.335 (33.91)	1.115 (28.32)	.884 (22.45)	.308 (7.82)	.185 (4.70)	.520 (13.21)	.250 (6.35)	.130 (3.30)
MDM-31SCBR*	1.335 (33.91)	1.115 (28.32)	.952 (24.18)	.308 (7.82)	.253 (6.43)	.520 (13.21)	.250 (6.35)	.130 (3.30)
MDM-37PCBR*	1.485 (37.72)	1.265 (32.13)	1.034 (26.26)	.308 (7.82)	.185 (4.70)	.520 (13.21)	.250 (6.35)	.130 (3.30)
MDM-37SCBR*	1.485 (37.72)	1.265 (32.13)	1.102 (27.99)	.308 (7.82)	.253 (6.43)	.520 (13.21)	.250 (6.35)	.130 (3.30)
MDM-51PCBR*	1.435 (36.45)	1.215 (30.86)	.984 (24.99)	.351 (8.92)	.228 (5.79)	.650 (16.15)	.300 (7.62)	.150 (3.81)
MDM-51SCBR*	1.435 (36.45)	1.215 (30.86)	1.052 (26.72)	.351 (8.92)	.296 (7.52)	.650 (16.15)	.300 (7.62)	.150 (3.81)
MDM-100PCBR*	2.170 (55.12)	1.800 (45.72)	1.384 (35.15)	.394 (10.01)	.271 (6.88)	1.000 (25.40)	.400 (10.16)	.200 (5.08)
MDM-100SCBR*	2.170 (55.12)	1.800 (45.72)	1.508 (38.10)	.394 (10.01)	.394 (10.01)	1.000 (25.40)	.400 (10.16)	.200 (5.08)

\*For jackpost, add letter "P" or "M7" for sizes 9-51, "M17" for size 100.

Dimensions shown in inch (mm)

Specifications and dimensions subject to change

www.ittcannon.com





# Micro-D Coaxial/Power - .050" Contact Spacing

# MDM C/P



## MDM Coaxial

The MDM Metal Shell Connectors have been tooled in several coaxial layouts and offer the versatility of combining coaxial and signal lines in the same connector. Any modifications to these layouts or new requirements, please consult the factory. Standard coax is RG178 white.

## MDM Power

The same insulator that is used with coaxial contacts is available with power contacts. This offers the versatility of combining power and signal lines in the same connector.

## MDM Coaxial/Power

Power and coaxial contacts can be interchanged as desired. Power contacts are rated at 13 amps, 24V rms, AWG #16 stranded.

## How to Order

For 83513-Style ordering information see pages 16 and 17

### SERIES

MDM: (Size 9-100) Liquid Crystal Polymer (LCP)  
MDM: (Combo Layout) Diallyl Phthalate (DAP)

### CONTACT ARRANGEMENTS

9-15-21-25-31-37-51-100 (standard)  
16C5, 10C10, 7C2, 24C4 (coaxial)  
16P5, 10P10, 7P2, 24P4 (power) } or combination of  
coax and power

### CONTACT TYPE

P - Pin S - Socket

### TERMINATION TYPE

H - Harness-insulated wire.  
L - Solid-uninsulated wire.  
S - Solder pot to accept #26 AWG MAX. harness wire. (Not available with power contact arrangements.)

### HARDWARE

M - Military specification hardware, see page 11 for military hardware codes.  
P - Jackpost  
K - Jackscrew-standard profile  
L - Jackscrew-low profile



### RoHS COMPLIANCE

### SERIES

### CONTACT ARRANGEMENTS

### CONTACT TYPE

### TERMINATION TYPE

### TERMINATION CODE

### HARDWARE

### SHELL FINISH MOD CODES

F - Float mount  
B - No hardware standard  
.091 (2.31) dia. hole for sizes 9-51;  
.120 (3.05) dia. hole for size 100.  
A - .125 (3.18) dia. mounting holes for sizes 9-51;  
.166 (4.22) dia. hole for size 100.  
B1 - .1475 (3.75) dia. hole for size 100  
(Per 83513-Style)

### TERMINATION CODE\*

(H) 001 - 18", 7/34 strand, #26 AWG, MIL-W-16878/4, Type E Teflon, yellow.  
(H) 003 - 18", 7/34 strand, #26 AWG, MIL-W-16878/4, Type E Teflon, color coded to MIL-STD-681 System I.

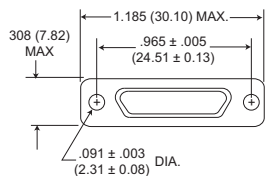
(L) 1 - 1/2" uninsulated solid #25 AWG gold plated copper.  
(L) 2 - 1" uninsulated solid #25 AWG gold plated copper.

### SHELL FINISH MOD CODES

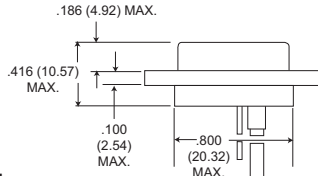
No Number - (Standard cadmium/yellow chromate over nickel)  
A174 - Electroless nickel  
A172 - Gold over nickel  
A141 - Iridite/alodine  
A30 - Black anodize

\*See page 79 and 81 for additional Termination codes.

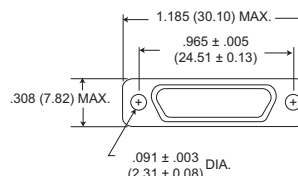
## 7C2/7P2



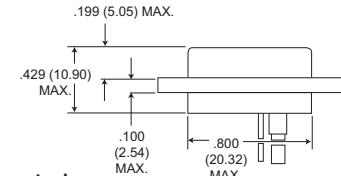
Plug



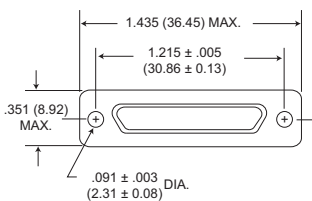
Receptacle



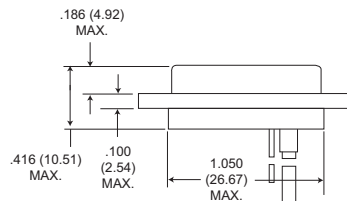
Receptacle



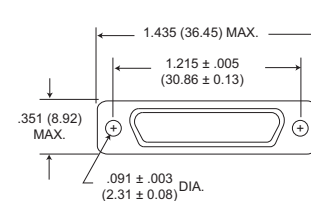
## 24C4/24P4



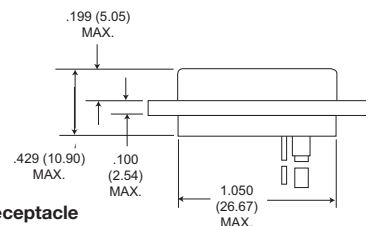
Plug



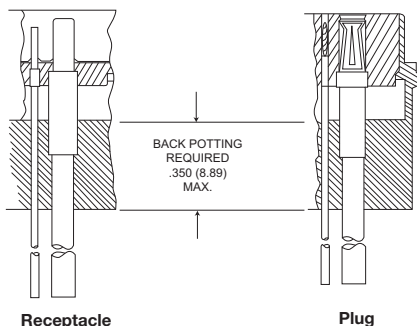
Receptacle



Receptacle



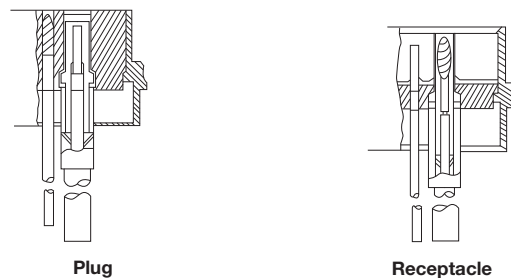
## Power Contacts



Receptacle

Plug

## Coaxial Contacts



Plug

Receptacle



Dimensions shown in inch (mm)  
Specifications and dimensions subject to change

www.ittcannon.com



MDMH connectors are ideal for applications requiring a better seal than can be achieved with epoxy resins.

The connector utilizes size 24 AWG contacts that are compression glass sealed through a steel shell and into a diallyl pthalate front end insulator. An interfacial seal provides environmental protection when mated. We recommend MDMH receptacles be soldered to the chassis or container for a completely leak-proof joint.

MDMH receptacles mate with standard MDM plugs.

## Features

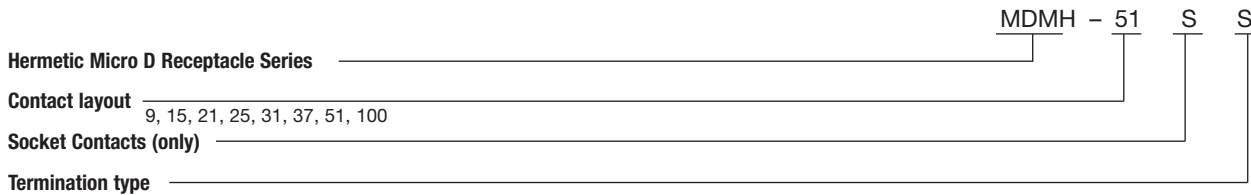
- Hermetically sealed connector designed for those applications where a vacuum, inert gas or a constant controlled pressure are required to eliminate adverse effects created by atmospheric changes.
- Steel shells to provide greater strength, prevent chipping, cracking or breaking, offer electro-magnetic (EMI) and RFI shielding.
- Silicone elastomer compression interfacial seal to provide a moisture and humidity seal between each contact and between contacts and shell.

## Specifications

### Standard materials & finishes

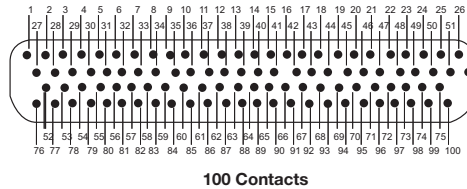
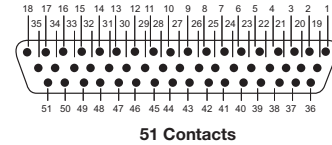
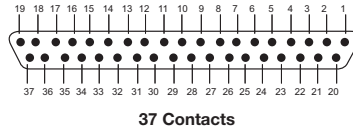
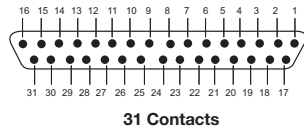
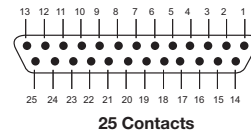
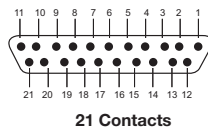
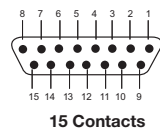
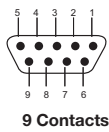
Shell	Mild steel, tin-lead plated
Insulator	Glass filled diallyl pthalate per MIL-M-14. Type SDGF
Contacts	Copper alloy, gold plated sockets on mild steel gold plated pins. Solder pots - mild steel gold plated
Hermetic seal	Compression glass
Leak rate	1 micron cubic ft/hr max (1.04 x 10 <sup>-5</sup> cc/sec at 1 ATM pressure differential)
<b>ELECTRICAL DATA</b>	
No. of contacts	9 to 100
Dielectric withstanding voltage	150 VAC
Insulation resistance	5000 Mohm minimum
Wire size	#26 through #30 AWG
Contact termination	Solder pot
<b>MECHANICAL FEATURES</b>	
Size or length	8 sizes
Service class	Hermetically sealed
Coupling	Friction/jacks
Polarization	Keystone shaped shells
Contact spacing	.050 (1,27) centers
Shell style	Receptacle, solder mount

## How to Order



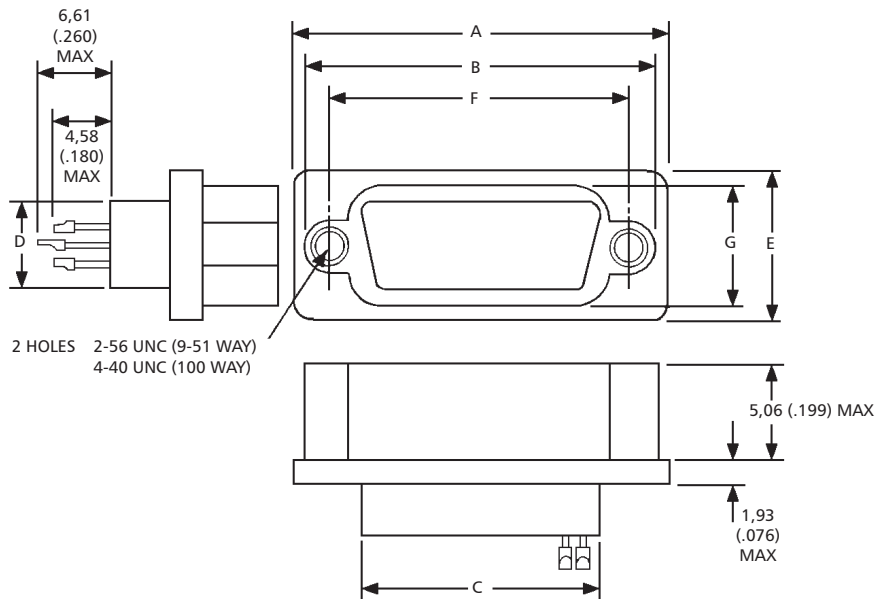
## Contact Arrangements

Face view of socket insert - use reverse order for wiring side.



Contact identification numbers are for reference only and do not appear on insulator or connector body.

## Shell Dimensions



Part Number by shell size	A max	B max	C max	D max	E max	F ±.005 (0,13)	G max
MDMH-9S	.885 (22,48)	.738 (18,74)	.400 (10,16)	.270 (6,86)	.430 (10,92)	.565 (14,35)	.261 (6,63)
MDMH-15S	1.035 (26,29)	.888 (22,55)	.550 (13,97)	.270 (6,86)	.430 (10,92)	.715 (18,16)	.261 (6,63)
MDMH-21S	1.185 (30,10)	1.038 (26,36)	.770 (17,78)	.270 (6,86)	.430 (10,92)	.865 (21,97)	.261 (6,63)
MDMH-25S	1.285 (32,64)	1.137 (28,87)	.800 (20,32)	.270 (6,86)	.430 (10,92)	.965 (24,51)	.261 (6,63)
MDMH-31S	1.435 (36,45)	1.288 (32,72)	.950 (24,13)	.270 (6,86)	.430 (10,92)	1.115 (28,32)	.261 (6,63)
MDMH-37S	1.585 (40,26)	1.438 (36,53)	1.100 (27,94)	.270 (6,86)	.430 (10,92)	1.265 (32,13)	.261 (6,63)
MDMH-51S	1.535 (38,99)	1.388 (35,26)	1.050 (26,67)	.310 (8,00)	.473 (12,01)	1.215 (30,86)	.315 (8,00)
MDMH-100S	2.275 (57,78)	2.078 (52,78)	1.455 (36,97)	.365 (9,27)	.522 (13,26)	1.800 (45,72)	.410 (10,41)



Dimensions shown in inch (mm)  
Specifications and dimensions subject to change

www.ittcannon.com



With an increasing number of MDM connectors being used in avionics and military equipment and with increasing emphasis being put on EMI, RFI and EMP shielding, Cannon have developed a range of filter connectors to suit most applications.

The TMDM receptacle accommodates from 8 to 37 sizes, 24 AWG socket contacts on 1,27 (.050) centres and mates with the standard MDM plugs.

### Features

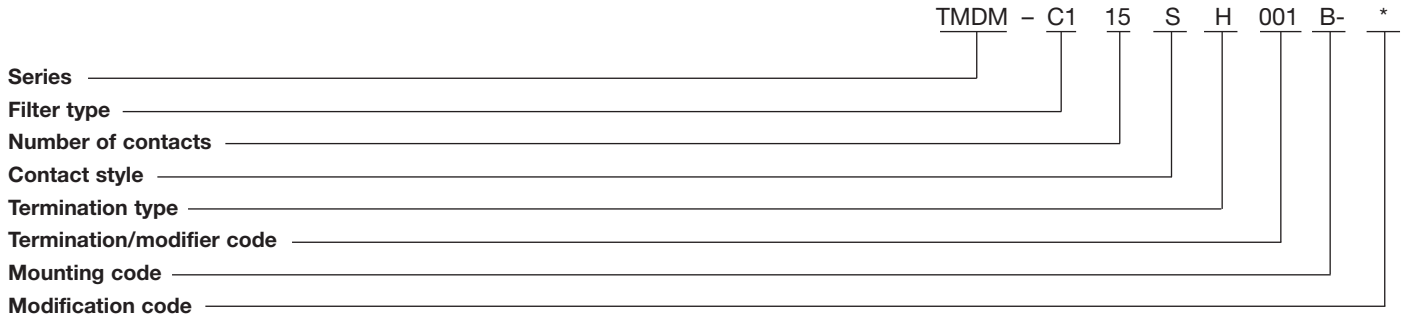
- Transverse monolith filter for EMI and RFI shielding.
- Rugged aluminum one piece shell.
- Silicone interfacial environmental seal.
- Glass filled diallyl phthalate insulator.
- A variety of filter types for each pin.

## Specifications

### Standard materials & finishes

Shell	Aluminum alloy per QQ-A-200/8 with electroless nickel finish per QQ-N-290
Insulator	Glass filled diallyl phthalate per MIL-M-14. Type SDGF
Contact, socket	Copper alloy, 50 microinch gold per MIL-G-45204, Type II, Class I
Interfacial seal	Silicone base rubber
<b>ELECTRICAL DATA</b>	
No. of contacts	9 to 37
Dielectric withstanding voltage	300 VAC
Insulation resistance	5000 Mohm at 100 VDC
Voltage rating (working)	100 VDC
Current rating	3 amps max.
Maximum capacitance	250, 500, 1000, 2000 picofarads
Filter type	C
<b>MECHANICAL FEATURES</b>	
Size or length	6 sizes
Coupling	Friction/jackscrews
Polarization	Keystone shaped shell
Contact spacing	.050 (1,27) centers
Shell style	Single piece receptacle

## How to Order



### Series:

Filter TMDM - Micro "D" - Metal housing

### Filter type:

- "C" capacitor type
- C1 150 - 250 pF capacitance
- C2 300 - 500 pF capacitance
- C3 700 - 1000 pF capacitance
- C4 1300 - 2000 pF capacitance

### Number of contacts:

9, 15, 21, 25, 31, 37 only

### Contact style:

- S - socket (receptacle)
- P - Pin (plug)

### Termination type:

- H - harness, insulated solid or stranded wire
- L - lead, solid uninsulated wire

### Termination:

Consult standard wire termination code for lead material and lead length

### Mounting code:

- A - Flange mounting, Ø.125 (3,18) mounting holes
- B - Flange mounting, Ø.092 (2,34) mounting holes
- L - Low profile (slotted head)
- M2 - Allen head jackscrew assembly,

low profile

- M3 - Allen head jackscrew assembly, high profile
- M5 - Slot head jackscrew assembly, low profile
- M6 - Slot head jackscrew assembly, high profile
- M7 - Jacknut assembly
- P - Jackpost

### Modification code:

Shell finish MOD. Codes. \*  
To be assigned as required

\* No number = Standard tin/lead finish

Dimensions shown in inch (mm)

Specifications and dimensions subject to change

www.ittcannon.com

