



Chipsmall Limited consists of a professional team with an average of over 10 year of expertise in the distribution of electronic components. Based in Hongkong, we have already established firm and mutual-benefit business relationships with customers from,Europe,America and south Asia,supplying obsolete and hard-to-find components to meet their specific needs.

With the principle of “Quality Parts,Customers Priority,Honest Operation,and Considerate Service”,our business mainly focus on the distribution of electronic components. Line cards we deal with include Microchip,ALPS,ROHM,Xilinx,Pulse,ON,Everlight and Freescale. Main products comprise IC,Modules,Potentiometer,IC Socket,Relay,Connector.Our parts cover such applications as commercial,industrial, and automotives areas.

We are looking forward to setting up business relationship with you and hope to provide you with the best service and solution. Let us make a better world for our industry!



Contact us

Tel: +86-755-8981 8866 Fax: +86-755-8427 6832

Email & Skype: info@chipsmall.com Web: www.chipsmall.com

Address: A1208, Overseas Decoration Building, #122 Zhenhua RD., Futian, Shenzhen, China





FEATURES

- RoHS compliant
- Basic/supplementary isolation to UL 60950²
- ANSI/AAMI ES60601-1
- Power density 0.81W/cm³
- Single and dual outputs
- UL 94V-0 package material
- Footprint 1.96cm²
- SIP package style
- 5.2kVDC isolation 'Hi Pot Test'
- 3.3V, 5V, 12V & 15V inputs
- 3.3V, 5V, 9V, 12V & 15V output
- Internal SMD construction
- Fully encapsulated with toroidal magnetics
- Pin compatible with the MEV, NMV, NMK, & NMJ series
- MTTF up to 4.2 million hours

PRODUCT OVERVIEW

The MEJ2 series are single and dual output medically approved DC/DC converters in a 7 pin SIP package style offering a power upgrade path from the NMJ series SIP DC/DC converters. The MEJ2 series is UL 60950 and ANSI/AAMI ES60601-1 recognized, which makes it ideal for applications where safety and miniaturisation are of paramount importance.

SELECTION GUIDE

| Order Code | Nominal Input Voltage | Output Voltage | Output Current | Input Current at Rated Load | Load Regulation (Typ) | Load Regulation (Max) | Ripple & Noise (Typ) ³ | Ripple & Noise (Max) ³ | Efficiency (Min) | Efficiency (Typ) | MTTF ² |
|-------------|-----------------------|----------------|----------------|-----------------------------|-----------------------|-----------------------|-----------------------------------|-----------------------------------|------------------|------------------|-------------------|
| | V | V | mA | | % | | mVp-p | | % | | kHrs |
| MEJ2S0303SC | 3.3 | 3.3 | 606 | 756 | 14.0 | 17 | 38 | 55 | 67 | 70 | 3910 |
| MEJ2S0305SC | 3.3 | 5 | 400 | 784 | 13.0 | 15 | 50 | 65 | 70 | 74 | 3757 |
| MEJ2S0503SC | 5 | 3.3 | 606 | 528 | 10.0 | 15 | 40 | 55 | 67 | 70 | 3830 |
| MEJ2S0505SC | 5 | 5 | 400 | 503 | 8.5 | 10 | 43 | 55 | 72 | 75 | 3654 |
| MEJ2S0509SC | 5 | 9 | 222 | 505 | 8.0 | 11 | 36 | 50 | 75 | 78 | 3472 |
| MEJ2S0512SC | 5 | 12 | 167 | 495 | 8.0 | 12 | 40 | 55 | 74 | 77 | 3663 |
| MEJ2S0515SC | 5 | 15 | 133 | 488 | 7.0 | 10 | 34 | 45 | 76 | 79 | 2629 |
| MEJ2S1203SC | 12 | 3.3 | 606 | 207 | 9.5 | 11 | 43 | 60 | 70 | 73 | 3259 |
| MEJ2S1205SC | 12 | 5 | 400 | 214 | 8.0 | 10 | 43 | 60 | 75 | 78 | 3200 |
| MEJ2S1209SC | 12 | 9 | 222 | 205 | 7.0 | 10 | 35 | 50 | 75 | 79 | 2453 |
| MEJ2S1212SC | 12 | 12 | 167 | 207 | 6.5 | 8 | 35 | 50 | 76 | 80 | 2779 |
| MEJ2S1215SC | 12 | 15 | 133 | 205 | 7.0 | 10 | 32 | 45 | 76 | 80 | 2707 |
| MEJ2S1505SC | 15 | 5 | 400 | 171 | 8.5 | 10 | 44 | 60 | 73 | 76 | 2638 |
| MEJ2S1509SC | 15 | 9 | 222 | 165 | 6.5 | 8 | 35 | 50 | 74 | 78 | 2203 |
| MEJ2S1512SC | 15 | 12 | 167 | 164 | 6.5 | 8 | 38 | 55 | 74 | 79 | 2330 |
| MEJ2S1515SC | 15 | 15 | 133 | 166 | 7.0 | 8 | 36 | 50 | 74 | 78 | 2100 |
| MEJ2D0503SC | 5 | ±3.3 | ±303 | 535 | 8.5 | 10 | 26 | 40 | 67 | 71 | 3969 |
| MEJ2D0505SC | 5 | ±5 | ±200 | 508 | 7.5 | 9 | 34 | 50 | 72 | 76 | 3654 |
| MEJ2D0509SC | 5 | ±9 | ±111 | 510 | 6.5 | 8 | 27 | 40 | 76 | 79 | 3472 |
| MEJ2D0512SC | 5 | ±12 | ±83 | 504 | 5.0 | 8 | 27 | 40 | 77 | 80 | 3663 |
| MEJ2D0515SC | 5 | ±15 | ±67 | 492 | 6.5 | 7 | 20 | 35 | 76 | 79 | 2629 |
| MEJ2D1203SC | 12 | ±3.3 | ±303 | 205 | 8.0 | 9 | 37 | 55 | 72 | 75 | 3270 |
| MEJ2D1205SC | 12 | ±5 | ±200 | 212 | 7.0 | 8 | 32 | 45 | 75 | 79 | 3268 |
| MEJ2D1209SC | 12 | ±9 | ±111 | 206 | 5.5 | 7 | 27 | 40 | 77 | 81 | 2453 |
| MEJ2D1212SC | 12 | ±12 | ±83 | 208 | 5.5 | 7 | 27 | 40 | 77 | 81 | 2779 |
| MEJ2D1215SC | 12 | ±15 | ±67 | 203 | 6.0 | 7 | 24 | 40 | 78 | 82 | 2707 |
| MEJ2D1505SC | 15 | ±5 | ±200 | 170 | 7.0 | 9 | 37 | 50 | 74 | 78 | 2638 |
| MEJ2D1509SC | 15 | ±9 | ±111 | 163 | 5.5 | 7 | 26 | 40 | 76 | 80 | 2203 |
| MEJ2D1512SC | 15 | ±12 | ±83 | 167 | 5.5 | 7 | 26 | 40 | 75 | 80 | 2330 |
| MEJ2D1515SC | 15 | ±15 | ±67 | 167 | 5.5 | 7 | 23 | 35 | 75 | 79 | 2100 |

INPUT CHARACTERISTICS

| Parameter | Conditions | Min. | Typ. | Max. | Units |
|------------------------|---------------------------------------|------|------|------|-------|
| Voltage range | Continuous operation, 3V input types | 2.97 | 3.3 | 3.63 | V |
| | Continuous operation, 5V input types | 4.5 | 5 | 5.5 | |
| | Continuous operation, 12V input types | 10.8 | 12 | 13.2 | |
| | Continuous operation, 15V input types | 13.5 | 15 | 16.5 | |
| Input reflected ripple | 3.3V input types | | 100 | 140 | mA |
| | 5V input types | | 60 | 90 | |
| | 12V & 15V input types | | 22 | 40 | |

1. Calculated using MIL-HDBK-217 FN2 calculation model with nominal input voltage at full load.
 2. See safety approvals section for limitations of use.
 3. See ripple & noise test method.
 All specifications typical at T_A=25°C, nominal input voltage and rated output current unless otherwise specified.



OUTPUT CHARACTERISTICS

| Parameter | Conditions | Min. | Typ. | Max. | Units |
|----------------------------|---|------|------|------|-------|
| Rated Power ² | T _A =-40°C to 85°C | | | 2 | W |
| Voltage Set Point Accuracy | See tolerance envelopes | | | | |
| Line regulation | High V _{IN} to low V _{IN} | | 1.0 | 1.2 | %/% |

ABSOLUTE MAXIMUM RATINGS

| | |
|---|------------|
| Short-circuit protection | 10 minutes |
| Lead temperature 1mm from case for 10 seconds | 260°C |
| Input voltage V _{IN} , MEJ2x03xxSC | 5V |
| Input voltage V _{IN} , MEJ2x05xxSC | 7V |
| Input voltage V _{IN} , MEJ2x12xxSC | 15V |
| Input voltage V _{IN} , MEJ2x15xxSC | 18V |

ISOLATION CHARACTERISTICS

| Parameter | Conditions | Min. | Typ. | Max. | Units |
|------------------------|---------------------------|------|------|------|-------|
| Isolation test voltage | Flash tested for 1 second | 5200 | | | VDC |
| Resistance | Viso= 500VDC | | 1 | | GΩ |
| Isolation capacitance | | | 4 | | pF |

GENERAL CHARACTERISTICS

| Parameter | Conditions | Min. | Typ. | Max. | Units |
|---------------------|------------|------|------|------|-------|
| Switching frequency | All types | | 45 | | kHz |

TEMPERATURE CHARACTERISTICS

| Parameter | Conditions | Min. | Typ. | Max. | Units |
|--------------------------------|--|------|------|------|-------|
| Specification | All output types (see safety approval section for limitations) | -40 | | 85 | °C |
| Storage | | -55 | | 125 | |
| Case Temperature above ambient | MEJ2S0509SC, MEJ2S0512SC, MEJ2S0515SC, MEJ2S1209SC, MEJ2x1212SC, MEJ2S1215SC, MEJ2S1509SC, MEJ2S1512SC, MEJ2S1515SC | | 27 | | |
| | MEJ2S0503SC, MEJ2S0505SC, MEJ2S1203SC, MEJ2S1205SC, MEJ2x1505SC, MEJ2S1515SC, MEJ2D0512SC, MEJ2D0515SC, MEJ2D1209SC, MEJ2D1215SC | | 30 | | |
| | MEJ2S0305SC, MEJ2S0303SC, MEJ2S1203SC, MEJ2D0505SC, MEJ2D0509SC, MEJ2D1205SC, MEJ2D1509SC, MEJ2D1512SC | | 33 | | |
| | MEJ2D01203SC, MEJ2D0503SC | | 37 | | |
| Cooling | Free air convection | | | | |

TEMPERATURE DERATING GRAPH

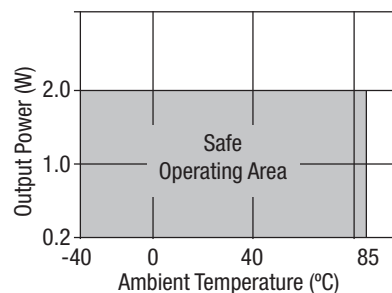

UL60950 recognition to a maximum ambient temperature of 85°C and/or case temperature limit of 155°C, measured on the face opposite the pins.

TOLERANCE ENVELOPE

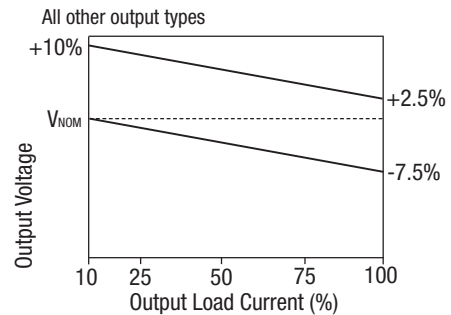
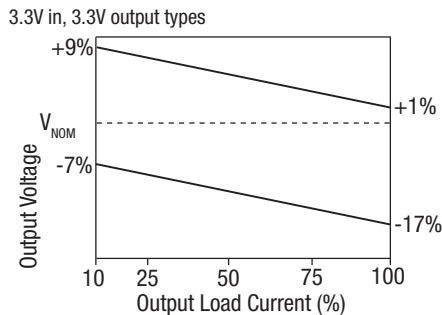

The voltage tolerance envelope shows typical load regulation characteristics for this product series. The tolerance envelope is the maximum output voltage variation due to changes in output loading.

TECHNICAL NOTES

ISOLATION VOLTAGE

'Hi Pot Test', 'Flash Tested', 'Withstand Voltage', 'Proof Voltage', 'Dielectric Withstand Voltage' & 'Isolation Test Voltage' are all terms that relate to the same thing, a test voltage, applied for a specified time, across a component designed to provide electrical isolation, to verify the integrity of that isolation.

Murata Power Solutions MEJ2 series of DC/DC converters are all 100% production tested at their stated isolation voltage. This is 5.2kVDC for 1 second.

A question commonly asked is, "What is the continuous voltage that can be applied across the part in normal operation?"

The MEJ2 series has been recognized by Underwriters Laboratory for various voltages, please see safety approval section below.

REPEATED HIGH-VOLTAGE ISOLATION TESTING

It is well known that repeated high-voltage isolation testing of a barrier component can actually degrade isolation capability, to a lesser or greater degree depending on materials, construction and environment. We therefore strongly advise against repeated high voltage isolation testing, but if it is absolutely required, that the voltage be reduced by 20% from specified test voltage.

SAFETY APPROVAL

ANSI/AAMI ES60601-1

The MEJ1 series has been tested by Underwriters Laboratory (UL) to meet ANSI/AAMI ES60601-1 medical safety standard providing the following MOOP (means of operator protection), in a maximum ambient temperature of 85°C and/or case temperature limit of 155°C (case temperature measured on the face opposite the pins): 1 MOOP based upon a working voltage of 200 Vrms max and 280 Vpk max., between Primary and Secondary and between Primary and its Enclosure. File Number E202895 applies.

UL 60950

The MEJ2 series has been recognized by Underwriters Laboratory (UL) to UL 60950 for basic/supplementary insulation to a working voltage of 300Vrms in a maximum ambient temperature of 85°C and/or case temperature limit of 130°C (case temperature measured on the face opposite the pins). File number E151252 applies.

FUSING

The MEJ2 Series of converters are not internally fused so to meet the requirements of UL an anti-surge input line fuse should always be used with ratings as defined below.

- MEJ2x03xxxC: 2A
- MEJ2x05xxxC: 2A
- MEJ2x12xxxC: 750mA
- MEJ2x15xxxC: 750mA

All fuses should be UL recognized and rated to at least the maximum allowable DC input voltage.

RoHS COMPLIANCE INFORMATION



This series is compatible with RoHS soldering systems with a peak wave solder temperature of 260°C for 10 seconds. The pin termination finish on this product series is Tin Plate, Hot Dipped over Matte Tin with Nickel Preplate. The series is backward compatible with Sn/Pb soldering systems. For further information, please visit www.murata-ps.com/rohs

APPLICATION NOTES

Minimum load

The minimum load to meet datasheet specification is 10% of the full rated load across the specified input voltage range. Lower than 10% minimum loading will result in an increase in output voltage, which may rise to typically double the specified output voltage if the output load falls to less than 5%.

Capacitive loading and start up

Typical start up times for this series, with a typical input voltage rise time of 2.2µs and output capacitance of 10µF, are shown in the table below. The product series will start into a capacitance of 47µF with an increased start time, however, the maximum recommended output capacitance is 10µF.

| | Start-up time ms | | Start-up time ms |
|-------------|---------------------|-------------|---------------------|
| MEJ2S0303SC | 0.89 | MEJ2S1515SC | 6.05 |
| MEJ2S0305SC | 1.89 | MEJ2D0503SC | 1.57 |
| MEJ2S0503SC | 1.08 | MEJ2D0505SC | 1.79 |
| MEJ2S0505SC | 2.04 | MEJ2D0509SC | 9.32 |
| MEJ2S0509SC | 6.5 | MEJ2D0512SC | 14.9 |
| MEJ2S0512SC | 8.29 | MEJ2D0515SC | 20.84 |
| MEJ2S0515SC | 11.4 | MEJ2D1203SC | 1.03 |
| MEJ2S1203SC | 0.73 | MEJ2D1205SC | 2.51 |
| MEJ2S1205SC | 1.61 | MEJ2D1209SC | 6.46 |
| MEJ2S1209SC | 4.04 | MEJ2D1212SC | 9.94 |
| MEJ2S1212SC | 5.51 | MEJ2D1215SC | 14.54 |
| MEJ2S1215SC | 7.61 | MEJ2D1505SC | 1.79 |
| MEJ2S1505SC | 1.33 | MEJ2D1509SC | 5.16 |
| MEJ2S1509SC | 3.37 | MEJ2D1512SC | 7.04 |
| MEJ2S1512SC | 4.47 | MEJ2D1515SC | 10.48 |

Typical Start-Up Wave Form

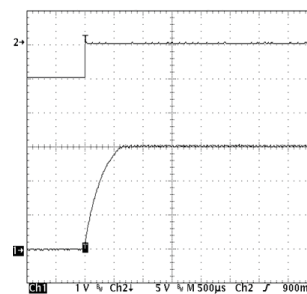

Ripple & Noise Characterisation Method

Ripple and noise measurements are performed with the following test configuration.

| | |
|-------|--|
| C1 | 1µF X7R multilayer ceramic capacitor, voltage rating to be a minimum of 3 times the output voltage of the DC/DC converter |
| C2 | 10µF tantalum capacitor, voltage rating to be a minimum of 1.5 times the output voltage of the DC/DC converter with an ESR of less than 100mΩ at 100 kHz |
| C3 | 100nF multilayer ceramic capacitor, general purpose |
| R1 | 450Ω resistor, carbon film, ±1% tolerance |
| R2 | 50Ω BNC termination |
| T1 | 3T of the coax cable through a ferrite toroid |
| RLOAD | Resistive load to the maximum power rating of the DC/DC converter. Connections should be made via twisted wires |

Measured values are multiplied by 10 to obtain the specified values.

Differential Mode Noise Test Schematic

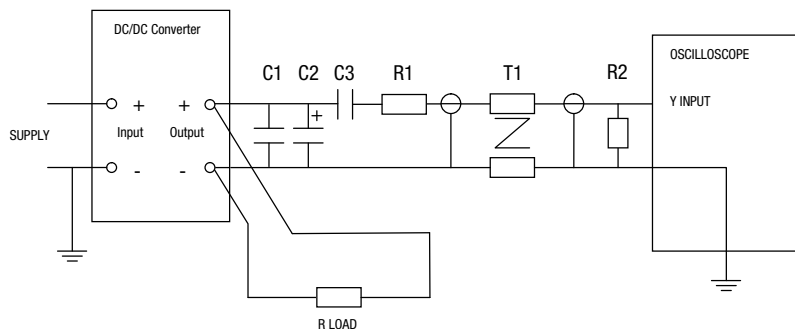

EFFICIENCY VS LOAD

MEJ2S03XXSC

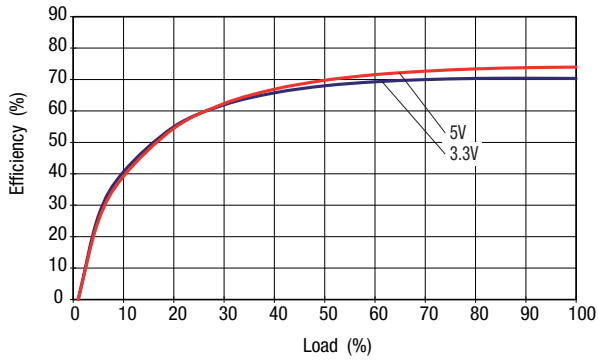

MEJ2S05XXSC

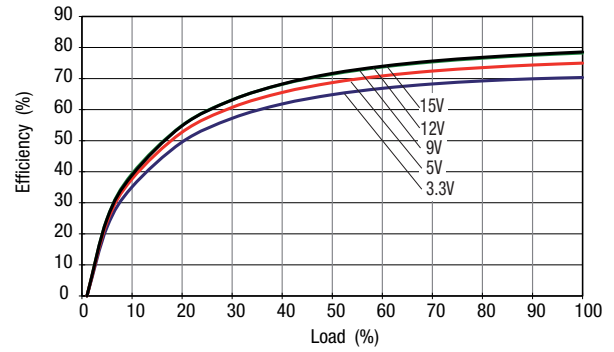

MEJ2S12XXSC

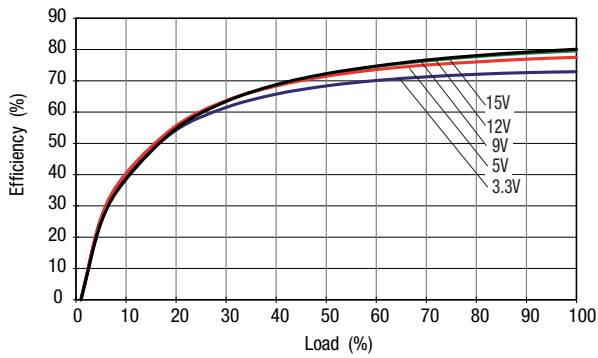

MEJ2S15XXSC

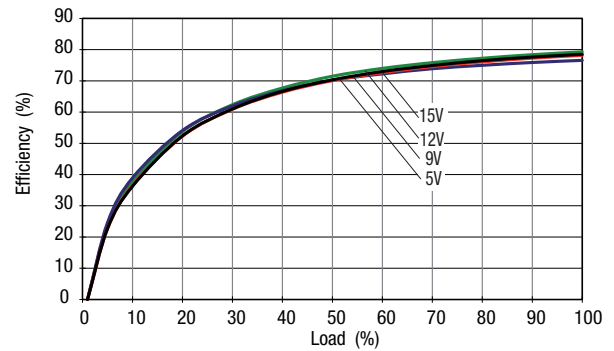

EFFICIENCY VS LOAD

MEJ2D05XXSC

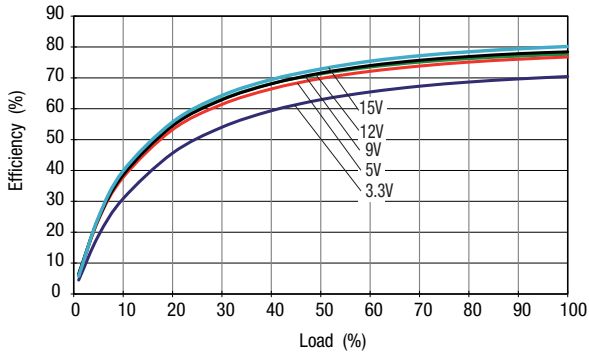

MEJ2D12XXSC

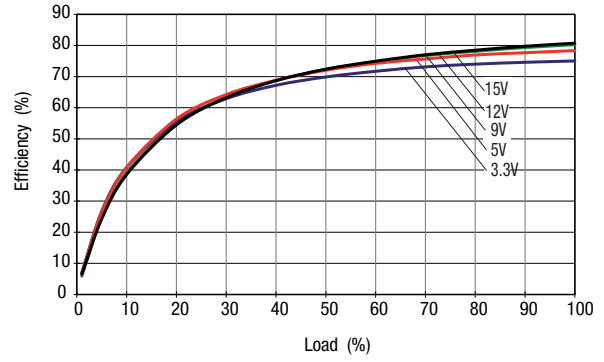

MEJ2D15XXSC

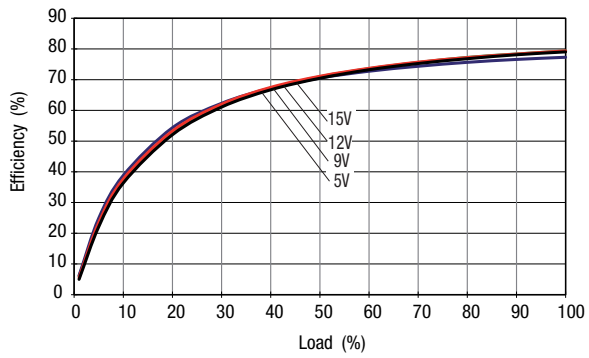

PACKAGE SPECIFICATIONS

MECHANICAL DIMENSIONS

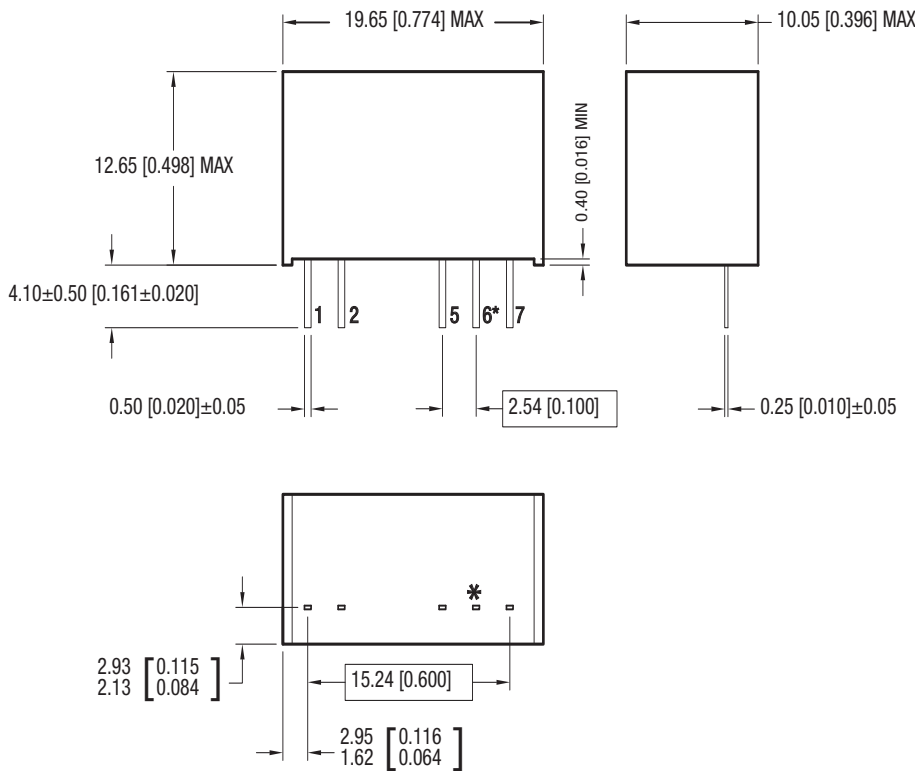

All dimensions in mm ±0.25mm (inches ±0.01). All pins on a 2.54 (0.1) pitch and within ±0.25 (0.01) of true position.
* Pin not fitted on single output variants.

Weight: 4.3g

PIN CONNECTIONS

Single Output

| Pin | Function |
|-----|----------|
| 1 | +Vin |
| 2 | -Vin |
| 5 | -Vout |
| 7 | +Vout |

Dual Output

| Pin | Function |
|-----|----------|
| 1 | +VIN |
| 2 | -VIN |
| 5 | -VOUT |
| 6* | OV |
| 7 | +VOUT |

TUBE OUTLINE DIMENSIONS

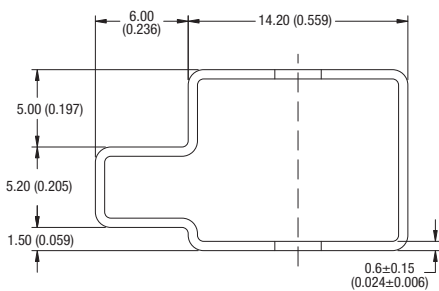

Unless otherwise stated all dimensions in mm ±0.5mm (inches ±0.02).
Tube length : 20.669±0.079 (525mm±2mm).

Tube Quantity : 25

RECOMMENDED FOOTPRINT DETAILS

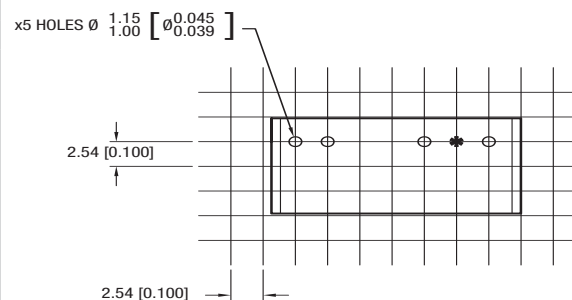

* Hole not required for single output variants.
All dimensions in mm ±0.25mm (inches ±0.01).

Murata Power Solutions, Inc.
11 Cabot Boulevard, Mansfield, MA 02048-1151 U.S.A.
ISO 9001 and 14001 REGISTERED



This product is subject to the following **operating requirements** and the **Life and Safety Critical Application Sales Policy**:
Refer to: <http://www.murata-ps.com/requirements/>

Murata Power Solutions, Inc. makes no representation that the use of its products in the circuits described herein, or the use of other technical information contained herein, will not infringe upon existing or future patent rights. The descriptions contained herein do not imply the granting of licenses to make, use, or sell equipment constructed in accordance therewith. Specifications are subject to change without notice.
© 2016 Murata Power Solutions, Inc.