



Chipsmall Limited consists of a professional team with an average of over 10 year of expertise in the distribution of electronic components. Based in Hongkong, we have already established firm and mutual-benefit business relationships with customers from,Europe,America and south Asia,supplying obsolete and hard-to-find components to meet their specific needs.

With the principle of “Quality Parts,Customers Priority,Honest Operation,and Considerate Service”,our business mainly focus on the distribution of electronic components. Line cards we deal with include Microchip,ALPS,ROHM,Xilinx,Pulse,ON,Everlight and Freescale. Main products comprise IC,Modules,Potentiometer,IC Socket,Relay,Connector.Our parts cover such applications as commercial,industrial, and automotives areas.

We are looking forward to setting up business relationship with you and hope to provide you with the best service and solution. Let us make a better world for our industry!



Contact us

Tel: +86-755-8981 8866 Fax: +86-755-8427 6832

Email & Skype: info@chipsmall.com Web: www.chipsmall.com

Address: A1208, Overseas Decoration Building, #122 Zhenhua RD., Futian, Shenzhen, China



Ultra Wideband Audio Transformers

- Highest Density Package Available
- Optimized for Audio Impedance
- Frequency Range: 300Hz - 100KHz
- HiPot: Most parts meet 1KVrms (Pri:Sec)

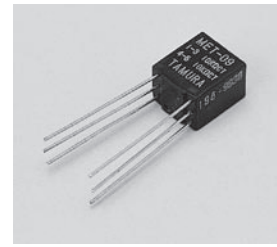

Tamura Part #	Impedance (Pri. Ω)	Impedance (Sec. Ω)	Turns Ratio (Pri:Sec)	UnBalance Current (mA)	Max. Pwr. Level (mW)	Freq. Response (dB)	DCR (Pri. Ω)	DCR (Sec. Ω)	Schematic Fig.
MET-01	200K CT	1K CT	14.1CT:1CT	0.0	10.0	+/-2	5300	120	1
MET-05	25K CT	1K CT	5CT:1CT	0.5	30.0	+/-2	1600	95	1
MET-09	10K CT	10K CT	1CT:1CT	1	40.0	+/-2	1000	1300	1
MET-11	10K CT	2K CT	2.23CT:1CT	1.0	40.0	+/-2	1000	300	1
MET-17	10K CT	500 CT	4.47CT:1CT	1.0	40.0	+/-2	1000	80	1
MET-23	1.6K CT	3.2	22.4CT:1	2.5	65.0	+/-3	186	0.8	3
MET-24	1.5K CT	600	1.58CT:1	3	50.0	+/-2	160	95	3
MET-28	1K	50	4.47:1	3.0	50.0	+/-2	110	8	4
MET-31 ¹	600 CT	600 CT	1CT:1CT	3	50.0	+/-2	70	95	1
MET-32	600	150/150	2:1:1	3	50.0	+/-2	70	95	2
MET-35	600 CT	8	8.66CT:1	4.5	50.0	+/-2	60	1.5	3
MET-39	500	50	3.16:1	3.0	50.0	+/-2	55	8	4
MET-42	150	12	3.54:1	10.0	50.0	+/-2	20	2.5	4
MET-46 ¹	600	600	1:1	3	50.0	+/-2	72	93	4
MET-50	10K	125	8.62:1	0.0	10.0	+/-3	1100	28	4
MET-59	600	150/150	1:1CT	3.0	50.0	+/-2	70	95	2
MET-60	135	135 CT	1:1CT	10	50.0	+/-2	10	10	5
METC-99	Optional Metal Shield								

¹ Meets FCC Parts 68 (Hi- Pot 1.5KV or 1.0KV)

Mechanical Dimensions mm (inches)

All dimensions are typical. Please contact Tamura for tolerances and suggested layout information.

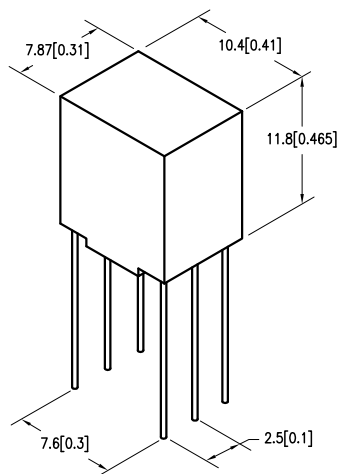

Schematics

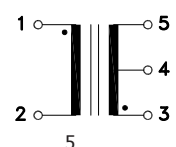
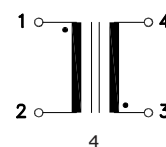
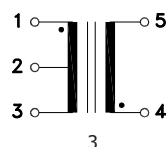
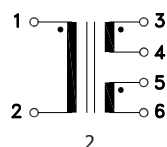
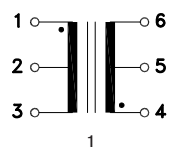

TAMURA CORPORATION

43352 Business Park Drive. | P.O. Box 892230 Temecula, CA 92589-2230 | www.tamuracorp.com

USA
Tel: 800-472-6624
Fax: 951-676-9482

Japan
Tel: 81 (0)3 3978-2111
Fax: 81 (0)3 3923-0230

United Kingdom
Tel: 44 (0) 1380 731 700
Fax: 44 (0) 1380 731 702

Hong Kong
Tel: 852-2389-4321
Fax: 852-2341-9689