



Chipsmall Limited consists of a professional team with an average of over 10 year of expertise in the distribution of electronic components. Based in Hongkong, we have already established firm and mutual-benefit business relationships with customers from,Europe,America and south Asia,supplying obsolete and hard-to-find components to meet their specific needs.

With the principle of “Quality Parts,Customers Priority,Honest Operation,and Considerate Service”,our business mainly focus on the distribution of electronic components. Line cards we deal with include Microchip,ALPS,ROHM,Xilinx,Pulse,ON,Everlight and Freescale. Main products comprise IC,Modules,Potentiometer,IC Socket,Relay,Connector.Our parts cover such applications as commercial,industrial, and automotives areas.

We are looking forward to setting up business relationship with you and hope to provide you with the best service and solution. Let us make a better world for our industry!



Contact us

Tel: +86-755-8981 8866 Fax: +86-755-8427 6832

Email & Skype: info@chipsmall.com Web: www.chipsmall.com

Address: A1208, Overseas Decoration Building, #122 Zhenhua RD., Futian, Shenzhen, China





Features

- Compliant with AEC-Q200 Rev-C- Stress Test Qualification for Passive Components in Automotive Applications
- Operating temperature range up to 125 °C
- Low thermal derating factor
- Higher hold currents at elevated temperature
- Choice of operating currents
- RoHS compliant* and halogen free**
- Resettable fault protection of general electronic equipment

MF-RHT Series - PTC Resettable Fuses

Electrical Characteristics

Model	V max. Volts	I max. Amps	I _{hold}	I _{trip}	Resistance		Max. Time To Trip		Tripped Power Dissipation
			Amperes at 23 °C		Ohms at 23 °C		Amperes at 23 °C	Seconds at 23 °C	Watts at 23 °C
			Hold	Trip	R _{Min.}	R _{1Max.} (Post Trip)		Max.	Typ.
MF-RHT050	30	40	0.5	0.92	0.48	1.10	2.5	2.5	0.9
MF-RHT070	16	40	0.7	1.4	0.3	0.8	3.5	4.0	1.4
MF-RHT200	16	100	2.0	3.8	0.045	0.110	12.5	3.0	1.4
MF-RHT450	16	100	4.5	7.8	0.022	0.054	22.5	3.0	3.6
MF-RHT650	16	100	6.5	12.0	0.011	0.026	32.5	5.5	4.3
MF-RHT750	16	100	7.5	13.1	0.0094	0.022	37.5	7.0	4.5
MF-RHT1300	16	100	13.0	24.0	0.0041	0.010	60.0	13.0	6.9

Environmental Characteristics

Operating Temperature.....	-40 °C to +125 °C
Storage Temperature.....	-40 °C to +85 °C
Passive Aging.....	+85 °C, 1000 hours..... ±15 % typical resistance change
Humidity Aging.....	+85 °C, 85 % R.H. 1000 hours..... ±15 % typical resistance change
Thermal Shock.....	MIL-STD-202, Method 107, +125 °C to -40 °C, 10 cycles..... ±10 % typical resistance change
Vibration.....	MIL-STD-883C, Method 2007.1, Condition A..... No change

Test Procedures And Requirements For Model MF-RHT Series

Test	Test Conditions	Accept/Reject Criteria
Visual/Mech.....	Verify dimensions and materials.....	Per MF physical description
Resistance.....	In still air @ 23 °C.....	R _{min} ≤ R ≤ R _{1max}
Time to Trip.....	At specified current, V _{max} , 23 °C.....	T ≤ max. time to trip (seconds)
Hold Current.....	30 min. at I _{hold}	No trip
Trip Cycle Life.....	V _{max} , I _{max} , 100 cycles.....	No arcing or burning
Trip Endurance.....	V _{max} , 48 hours.....	No arcing or burning
Solderability.....	MIL-STD-202, Method 208.....	95 % min. coverage

Thermal Derating Chart - I_{hold} (Amps)

Model	Ambient Operating Temperature									
	-40 °C	-20 °C	0 °C	23 °C	40 °C	50 °C	60 °C	70 °C	85 °C	125 °C
MF-RHT050	0.68	0.62	0.56	0.5	0.44	0.4	0.36	0.34	0.28	0.12
MF-RHT070	0.95	0.87	0.79	0.7	0.62	0.56	0.51	0.47	0.39	0.17
MF-RHT200	2.71	2.49	2.26	2.00	1.77	1.60	1.46	1.34	1.11	0.49
MF-RHT450	6.1	5.6	5.1	4.5	4.0	3.6	3.3	3.0	2.5	1.1
MF-RHT650	8.8	8.1	7.4	6.5	5.7	5.3	4.8	4.3	3.6	1.6
MF-RHT750	10.2	9.4	8.6	7.5	6.6	6.1	5.6	5.0	4.1	1.9
MF-RHT1300	17.7	16.3	14.8	13.0	11.4	10.5	9.6	8.6	7.2	3.3

How to Order

Multifuse® Product Designator _____ **MF - RHT 750 - - 14**

Series _____
 RHT = High Temperature Radial Leaded Component

Hold Current, I_{hold} _____
 050 - 1300 (0.70 - 13.00 Amps)

Packaging Options _____
 - = Bulk Packaging
 - 2 = Tape and Reel*
 - AP = Ammo-Pak*

Part Number Suffix Option _____
 - 14 = Kinked Leads in Place of Standard Straight Leads
 - 17 = Straight Leads in Place of Standard Kinked Leads

*Packaged per EIA 486-B

* RoHS Directive 2002/95/EC Jan. 27, 2003 including annex and RoHS Recast 2011/65/EU June 8, 2011.

** Bourns considers a product to be "halogen free" if (a) the Bromine (Br) content is 900 ppm or less; (b) the Chlorine (Cl) content is 900 ppm or less; and (c) the total Bromine (Br) and Chlorine (Cl) content is 1500 ppm or less.

Specifications are subject to change without notice. The device characteristics and parameters in this data sheet can and do vary in different applications and actual device performance may vary over time. Users should verify actual device performance in their specific applications.

Applications

- Protection of automotive circuitry including engine control modules
- Overcurrent surge protection of electronic equipment required to operate at high operating temperature ranges
- Resettable fault protection of general electronic equipment

MF-RHT Series - PTC Resettable Fuses

BOURNS®

Product Dimensions

Model	A	B	C		D	E	F	Physical Characteristics	
	Max.	Max.	Nom.	Tol. ±	Min.	Max.	Nom.	Style	Material
MF-RHT050	$\frac{7.40}{(0.291)}$	$\frac{12.7}{(0.500)}$	$\frac{5.1}{(0.201)}$	$\frac{0.7}{(0.028)}$	$\frac{7.6}{(0.30)}$	$\frac{3.0}{(0.12)}$	$\frac{0.51}{(0.020)}$	3	Sn/CuFe
MF-RHT070	$\frac{6.86}{(0.27)}$	$\frac{10.8}{(0.425)}$	$\frac{5.1}{(0.201)}$	$\frac{0.7}{(0.028)}$	$\frac{7.6}{(0.30)}$	$\frac{3.0}{(0.12)}$	$\frac{0.51}{(0.020)}$	1	Sn/CuFe
MF-RHT200	$\frac{9.4}{(0.37)}$	$\frac{14.0}{(0.55)}$	$\frac{5.1}{(0.201)}$	$\frac{0.7}{(0.028)}$	$\frac{7.6}{(0.30)}$	$\frac{3.0}{(0.12)}$	$\frac{0.51}{(0.020)}$	3	Sn/Cu
MF-RHT450	$\frac{10.4}{(0.41)}$	$\frac{15.6}{(0.61)}$	$\frac{5.1}{(0.201)}$	$\frac{0.7}{(0.028)}$	$\frac{7.6}{(0.30)}$	$\frac{3.0}{(0.12)}$	$\frac{0.81}{(0.032)}$	2	Sn/Cu
MF-RHT650	$\frac{12.7}{(0.50)}$	$\frac{22.2}{(0.88)}$	$\frac{5.1}{(0.201)}$	$\frac{0.7}{(0.028)}$	$\frac{7.6}{(0.30)}$	$\frac{3.0}{(0.12)}$	$\frac{0.81}{(0.032)}$	2	Sn/Cu
MF-RHT750	$\frac{14.0}{(0.55)}$	$\frac{23.5}{(0.93)}$	$\frac{5.1}{(0.201)}$	$\frac{0.7}{(0.028)}$	$\frac{7.6}{(0.30)}$	$\frac{3.0}{(0.12)}$	$\frac{0.81}{(0.032)}$	2	Sn/Cu
MF-RHT1300	$\frac{23.5}{(0.925)}$	$\frac{28.7}{(1.17)}$	$\frac{10.2}{(0.402)}$	$\frac{0.7}{(0.028)}$	$\frac{7.6}{(0.30)}$	$\frac{3.6}{(0.14)}$	$\frac{1.0}{(0.040)}$	2	Sn/Cu

Packaging:

BULK: 500 pcs. per bag

TAPE & REEL: MF-RHT050 ~ MF-RHT200 = 3000 pcs. per reel; MF-RHT450 ~ MF-RHT650 = 1500 pcs. per reel;
MF-RHT750 ~ MF-RHT1300 = 1000 pcs. per reel

AMMO-PACK: MF-RHT050 ~ MF-RHT200 = 2000 pcs. per pack; MF-RHT450 ~ MF-RHT750 = 1000 pcs. per pack;
MF-RHT1300 = 500 pcs. per pack

0.51 (24AWG) DIMENSIONS: $\frac{\text{MM}}{\text{(INCHES)}}$
0.81 (20AWG)
1.0 (18AWG)

Style 1

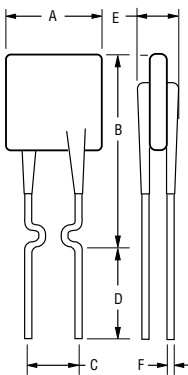

Style 2

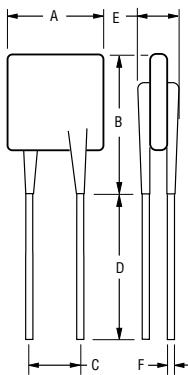

Style □

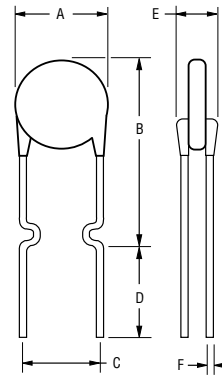

Also available with kinked and straight leads in place of standard leads (see How to Order).

Typical Part Marking

Represents total content. Layout may vary.

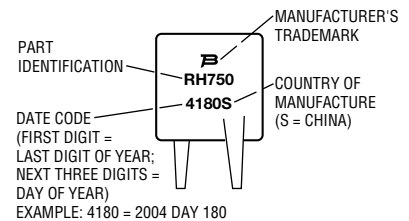

Typical Time to Trip at 23 °C

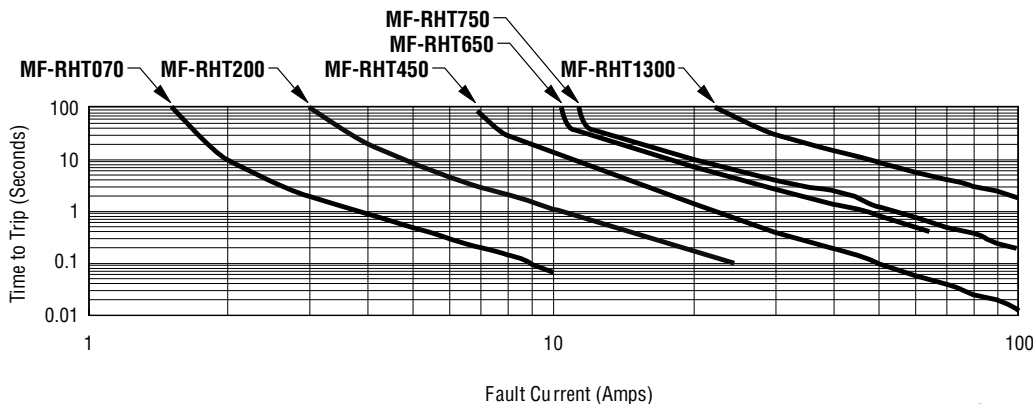

The Time to Trip curves represent typical performance of a device in a simulated application environment. Actual performance in specific customer applications may differ from these values due to the influence of other variables.

MF-RHT SERIES, REV. J, 09/16

Specifications are subject to change without notice.

The device characteristics and parameters in this data sheet can and do vary in different applications and actual device performance may vary over time. Users should verify actual device performance in their specific applications.

MF-RHT Series Tape and Reel Specifications

BOURNS®

Devices taped using EIA468-B/IEC60286-2 standards. See table below and Figures 1 and 2 for details.

Dimension Description	IEC Mark	EIA Mark	Dimensions	
			Dimensions	Tolerance
Carrier tape width	W	W	$\frac{18}{(.709)}$	$\frac{-0.5/+1.0}{(-0.02/+0.039)}$
Hold down tape width	W_0	W_4	$\frac{11}{(.433)}$	min.
Hold down tape			No protrusion	
Top distance between tape edges	W_2	W_6	$\frac{3}{(.118)}$	max.
Sprocket hole position	W_1	W_5	$\frac{9}{(.354)}$	$\frac{-0.5/+0.75}{(-0.02/+0.03)}$
Sprocket hole diameter	D_0	D_0	$\frac{4}{(.157)}$	$\frac{\pm 0.2}{(\pm .0078)}$
Abscissa to plane (straight lead)	H	H	$\frac{18.5}{(.728)}$	$\frac{\pm 3.0}{(\pm .118)}$
Abscissa to plane (kinked lead)	H_0	H_0	$\frac{16}{(.63)}$	$\frac{\pm 0.5}{(\pm .02)}$
Abscissa to top: MF-RHT050 ~ MF-RHT450	H_1	H_1	$\frac{32.2}{(1.268)}$	max.
Abscissa to top: MF-RHT650 ~ MF-RHT1300	H_1	H_1	$\frac{45.0}{(1.837)}$	max.
Overall width w/lead protrusion: MF-RHT050 ~ MF-RHT450		C_1	$\frac{42.5}{(1.673)}$	max.
Overall width w/lead protrusion: MF-RHT650 ~ MF-RHT1300		C_1	$\frac{55.0}{(2.165)}$	max.
Overall width w/o lead protrusion: MF-RHT050 ~ MF-RHT450		C_2	$\frac{42.5}{(1.673)}$	max.
Overall width w/o lead protrusion: MF-RHT650 ~ MF-RHT1300		C_2	$\frac{54.0}{(2.126)}$	max.
Lead protrusion	l_1	L_1	$\frac{1.0}{(.039)}$	max.
Protrusion of cutout	L	L	$\frac{11}{(.433)}$	max.
Protrusion beyond hold-down tape	l_2	l_2	Not specified	
Sprocket hole pitch	P_0	P_0	$\frac{12.7}{(0.5)}$	$\frac{\pm 0.3}{(\pm .012)}$
Pitch tolerance			20 consecutive	$\frac{\pm 1}{(\pm .039)}$
Device pitch: MF-RHT070 ~ MF-RHT450			$\frac{12.7}{(0.5)}$	$\frac{\pm 0.3}{(\pm .012)}$
Device pitch: MF-RHT050 and MF-RHT650 ~ MF-RHT1300			$\frac{25.4}{(1.0)}$	$\frac{\pm 0.6}{(\pm .024)}$
Tape thickness	t	t	$\frac{0.9}{(.035)}$	max.
Tape thickness with splice: MF-RHT050 ~ MF-RHT200		t_1	$\frac{1.5}{(.059)}$	max.
Tape thickness with splice: MF-RHT450 ~ MF-RHT1300		t_1	$\frac{2.3}{(.091)}$	max.
Splice sprocket hole alignment			$\frac{4.0}{(.157)}$	$\frac{\pm 0.2}{(\pm .008)}$
Body lateral deviation	Δ_h	Δ_h	0	$\frac{\pm 1}{(\pm .039)}$
Body tape plane deviation	Δ_p	Δ_p	0	$\frac{\pm 0.3}{(\pm .012)}$
Ordinate to adjacent component lead	P_1	P_1	$\frac{3.81}{(.015)}$	$\frac{\pm 0.07}{(\pm .028)}$

DIMENSIONS: $\frac{\text{MM}}{\text{(INCHES)}}$

Specifications are subject to change without notice.

The device characteristics and parameters in this data sheet can and do vary in different applications and actual device performance may vary over time. Users should verify actual device performance in their specific applications.

MF-RHT Series Tape and Reel Specifications

BOURNS®

Dimension Description	IEC Mark	EIA Mark	Dimensions	
			Dimensions	Tolerance
Lead spacing: MF-RHT050 ~ MF-RHT750	F	F	$\frac{5.08}{(0.2)}$	$\frac{-0.2/+0.8}{(-0.006/+0.031)}$
Lead spacing: MF-RHT1300	F	F	$\frac{10.2}{(0.402)}$	$\frac{-0.2/+0.8}{(-0.006/+0.031)}$
Reel width: MF-RHT050 ~ MF-RHT450	w	W ₂	$\frac{56}{(2.20)}$	max.
Reel width: MF-RHT650 ~ MF-RHT1300	w	W ₂	$\frac{63.5}{(2.50)}$	max.
Reel diameter	d	a	$\frac{370.0}{(14.57)}$	max.
Space between flanges less device	W ₁	h	$\frac{4.75}{(.187)}$	$\frac{\pm 3.25}{(\pm .128)}$
Arbor hole diameter	f	c	$\frac{26.0}{(1.02)}$	$\frac{\pm 12.0}{(\pm .472)}$
Core diameter	h	n	$\frac{80.0}{(3.15)}$	max.
Box			$\frac{62}{(2.44)}$	$\frac{355}{(14.0)}$ $\frac{345}{(13.6)}$
Consecutive missing places			3	max.
Empty places per reel			Not specified	

Taped Component Dimensions - Figure 1

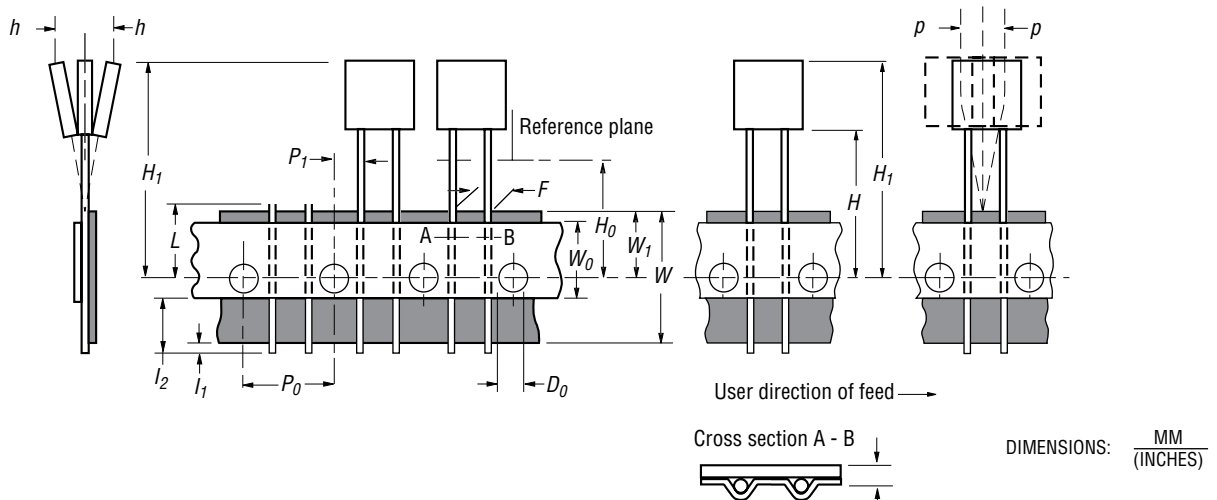

Reel Dimensions - Figure 2

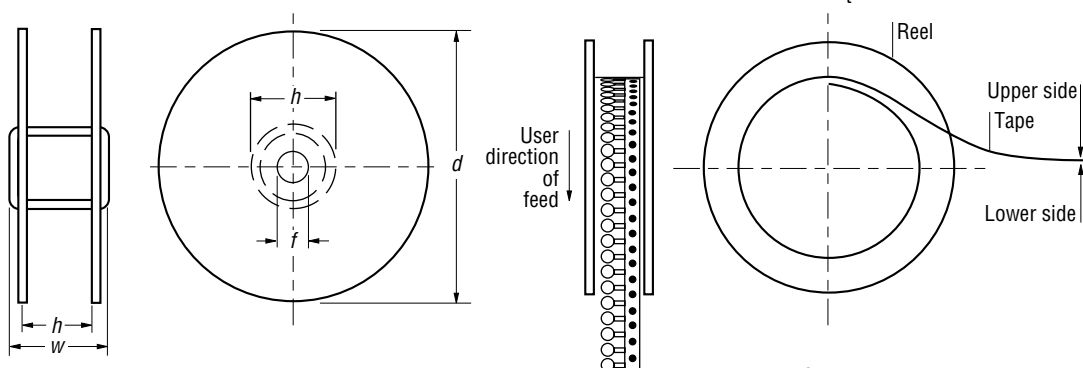

Specifications are subject to change without notice. The device characteristics and parameters in this data sheet can and do vary in different applications and actual device performance may vary over time. Users should verify actual device performance in their specific applications.