



Chipsmall Limited consists of a professional team with an average of over 10 year of expertise in the distribution of electronic components. Based in Hongkong, we have already established firm and mutual-benefit business relationships with customers from,Europe,America and south Asia,supplying obsolete and hard-to-find components to meet their specific needs.

With the principle of “Quality Parts,Customers Priority,Honest Operation,and Considerate Service”,our business mainly focus on the distribution of electronic components. Line cards we deal with include Microchip,ALPS,ROHM,Xilinx,Pulse,ON,Everlight and Freescale. Main products comprise IC,Modules,Potentiometer,IC Socket,Relay,Connector.Our parts cover such applications as commercial,industrial, and automotives areas.

We are looking forward to setting up business relationship with you and hope to provide you with the best service and solution. Let us make a better world for our industry!



Contact us

Tel: +86-755-8981 8866 Fax: +86-755-8427 6832

Email & Skype: info@chipsmall.com Web: www.chipsmall.com

Address: A1208, Overseas Decoration Building, #122 Zhenhua RD., Futian, Shenzhen, China



Solutions Seeking Problems.

MAGNASPHERE® 

N-Series



The original Magnasphere switch design. Robust all metal construction is highly resistant to magnetic tamper and defeat, and permanent contact welding from power surges. Can also be used as a close tolerance ferrous metal proximity sensor (no magnet actuator required).

CONTACT CHARACTERISTICS

Contact Form: A (Normally Open-N.O.)
Contact Material: Gold/Gold
Initial Contact Resistance (Typical):
< 150 Milli Ohms
Contact Capacitance: < 1 pf
Contact Ratings: 30 VDC @ 250 ma
Contact Bounce* (Typical): < 10
milliseconds*. Recommended trial
de-bounce - 15 milliseconds (min.)
closed contact condition for logic state
changes - or 30 Hz low pass filter buffer
Minimum Breakdown Voltage (Typical):
300 VDC
Insulation Resistance (Typical):
> 5 Mega Ohms

OPERATION CHARACTERISTICS

Operate/Release Values:
See Switching Characteristics Table
Actuation Magnet Orientation:
Either Pole
Maximum Operating Frequency: 20 Hz
Mounting Position: Any Plane
Operating Temperature: -40°C to +150°C
Shock (Switch Damage): > 100 G's
Vibration: 10-15 G's (80-450 Hz)
(Higher Values Available)

GENERAL CHARACTERISTICS & INFORMATION

Construction: Non-Ferrous Metal Housing,
Compression Seal Hermetically Sealed,
Protective Gas Atmosphere, Precious
Metal Plated Spherical Magnet Contact.

Soldering Guidelines: 600° F (315° C)
Temperature iron for 5 sec. (max.). Do
not solder within 1/8" (3 mm) of glass
seal. Lead pins precious metal plated
for enhanced solderability.

Termination Polarity Guidelines: Polarity
selection is non-critical, though some

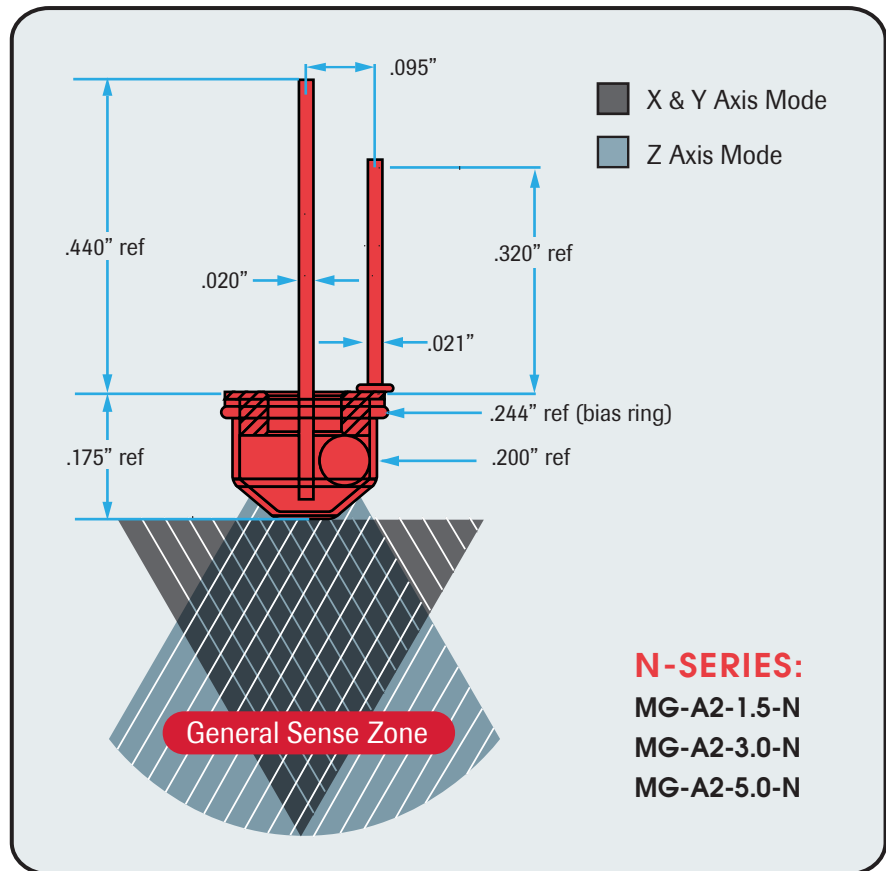

life gain may be realized by center pin
as cathode on logic loads, but center
pin as anode on larger loads.

Lead Wire Cutting / Bending Guidelines:
Cut length has no effect on magnetic
OP/REL values. Shearing action type
cutters are recommended, but end nippers
and side cutters are NOT recommended.
Metal style seals are extraordinarily
rugged, but the bending of unsupported
lead wire pins adjacent to the glass seal
is not recommended (i.e. when bending

use the support of some type of parallel
jaws spaced away from the glass seal to
grip the lead wire pins while bending
the pins' free ends, so no bending
strains are imposed on the glass seal.

Other Comments: Ferromagnetic materi-
als and strong Electromagnetic devices
proximate to the switch or its actuator
magnet may adversely affect expected
OP/REL switching values. Experimenta-
tion is recommended to investigate
areas of concern.

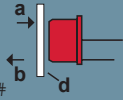
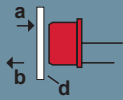
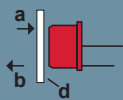
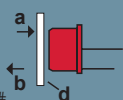
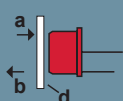
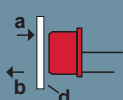

The Most Advanced and Effective Magnetic Sensor

		SWITCHING CHARACTERISTICS		AIR GAP DISTANCE			
		POSITION	TYPICAL	MIN	MAX		
The Most Advanced and Effective Magnetic Sensor	MG-A2-1.5-N <small>Consult factory regarding application/use of this part#</small> 	(a) Leads Horz. "CLOSED" (b) Leads Horz. "OPEN"	.818" 1.313"	.521" .795"	1.115" 1.431"	NEO 35 MAGNET TARGET 0.5" L x .375" T	
	MG-A2-3.0-N 	(a) Leads Horz. "CLOSED" (b) Leads Horz. "OPEN"	.652" .897"	.463" .518"	.841" 1.276"		
	MG-A2-5.0-N 	(a) Leads Horz. "CLOSED" (b) Leads Horz. "OPEN"	.569" .643"	.320" .460"	.818" .826"		
	MG-A2-1.5-N <small>Consult factory regarding application/use of this part#</small> 	(a) Leads Horz. "CLOSED" (b) Leads Horz. "OPEN"	.053" .089"	.035" .059"	.071" .119"	FERROUS METAL TARGET EG. C1010 Low Carbon 1.0" L x 1.0" W x .0625" T	
	MG-A2-3.0-N 	(a) Leads Horz. "CLOSED" (b) Leads Horz. "OPEN"	.034" .061"	.022" .037"	.046" .085"		
	MG-A2-5.0-N 	(a) Leads Horz. "CLOSED" (b) Leads Horz. "OPEN"	.030" .048"	.021" .036"	.041" .060"		

N-Series

Switching characteristics the target moves closer (a), this normally open switch will CLOSE at the air gap distance (d), and OPEN when the target moves away (b).

ABOUT MAGNASPHERE

MAGNASPHERE® Corp. is a privately held company founded in 2002, with the purpose of providing superior performing magnetic switch and sensor technology to the industrial/commercial OEM and security markets. MAGNASPHERE's patented, award-winning technology establishes new standards for magnetic switch performance while providing an affordable and more effective alternative to other magnetic switch technologies.

Learn more: Visit us at www.MAGNASPHERE.com.



PATENTED DESIGN

MAGNASPHERE® products are covered by one or more of the following U.S. and international patents:

- #5332992
- #5530428
- #5673021
- #5880659
- #5977873
- #6087936
- #6506987
- #6603378
- #6803845
- #7023308
- (Patents Pending)

MAGNASPHERE® NOTICE OF LIMITED LICENSE AND RIGHTS: (Security Applications)
 The purchase of MAGNASPHERE® switches provides the purchaser and the purchaser's customers with a limited right and license to make, use, offer for sale, and sell security devices, each making use of a single MAGNASPHERE® switch; however, this limited right and license does not extend to and specifically excludes security devices making use of two or more MAGNASPHERE® switches that cooperatively monitor a single area or location.

INDUSTRY AWARDS

- Best of Show Award:**
ISC Expo
- Gold Award**
Sensor Technology:
Sensors Expo
- Best Intrusion**
Detection:
ISC Expo