



Chipsmall Limited consists of a professional team with an average of over 10 year of expertise in the distribution of electronic components. Based in Hongkong, we have already established firm and mutual-benefit business relationships with customers from,Europe,America and south Asia,supplying obsolete and hard-to-find components to meet their specific needs.

With the principle of "Quality Parts,Customers Priority,Honest Operation,and Considerate Service",our business mainly focus on the distribution of electronic components. Line cards we deal with include Microchip,ALPS,ROHM,Xilinx,Pulse,ON,Everlight and Freescale. Main products comprise IC,Modules,Potentiometer,IC Socket,Relay,Connector.Our parts cover such applications as commercial,industrial, and automotives areas.

We are looking forward to setting up business relationship with you and hope to provide you with the best service and solution. Let us make a better world for our industry!



## Contact us

Tel: +86-755-8981 8866 Fax: +86-755-8427 6832

Email & Skype: info@chipsmall.com Web: www.chipsmall.com

Address: A1208, Overseas Decoration Building, #122 Zhenhua RD., Futian, Shenzhen, China



# MGA-31189

## 0.25W High Gain Driver Amplifier

### 50 – 2000 MHz



## Data Sheet

### Description

Avago Technologies MGA-31189 is a 0.25W high gain with good gain flatness Driver Amplifier MMIC, housed in a standard SOT-89 plastic package. The device features high linearity performance, excellent input and output return loss, and low noise figure. The device can be easily matched to obtain optimum power and linearity.

MGA-31189 is externally tunable to operate within 50MHz to 2GHz frequency range applications. With high IP3, low noise figure and wideband operation, the MGA-31189 can be utilized as a driver amplifier in the transmit chain and as a second stage LNA in the receive chain.

This device uses Avago Technologies proprietary 0.25um GaAs Enhancement mode PHEMT process.

### Pin connections and Package Marking

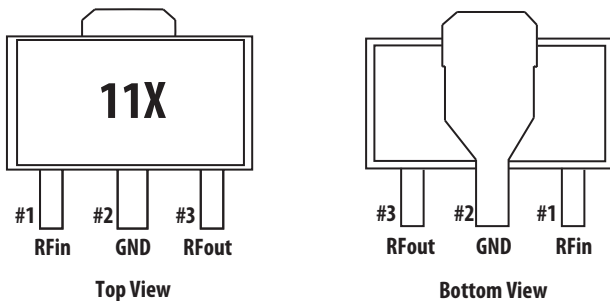

Notes:  
 Top View : Package marking provides orientation and identification  
 "11" = Device Code  
 "X" = Date Code character identifies month of manufacturing



**Attention: Observe precautions for handling electrostatic sensitive devices.**  
 ESD Machine Model = 100 V  
 ESD Human Body Model = 400 V  
 Refer to Avago Application Note A004R: Electrostatic Discharge, Damage and Control.

### Features

- ROHS compliant
- Halogen free
- Very high linearity at low DC bias power <sup>[1]</sup>
- High Gain
- Good gain flatness
- Low noise figure
- Excellent uniformity in product specification
- SOT-89 standard package

### Specifications

**At 0.9GHz, Vdd = 5V, Idd = 111mA (typ) @ 25°C**

- OIP3 = 42dBm
- Noise Figure = 2.0dB
- Gain = 21dB; Gain Flatness (+/-50MHz) = 0.1dB
- P1dB = 24 dBm
- IRL = 15.6dB, ORL = 12.8dB

Note:  
 1. The MGA-31189 has a superior LFOM of 14.5dB. Linearity Figure of Merit (LFOM) is essentially OIP3 divided by DC bias power.

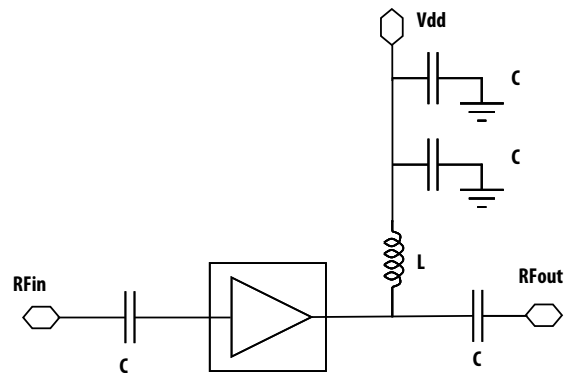

Figure 1. Simplified Schematic diagram

## MGA-31189 Absolute Maximum Rating<sup>[1]</sup> T<sub>A</sub>=25°C

Symbol	Parameter	Units	Absolute Maximum
I <sub>d,max</sub>	Drain Current	mA	150
V <sub>d,max</sub>	Device Voltage	V	5.5
P <sub>d</sub>	Power Dissipation <sup>[2]</sup>	mW	825
P <sub>in,max</sub>	CW RF Input Power	dBm	25
T <sub>j,max</sub>	Junction Temperature	°C	150
T <sub>stg</sub>	Storage Temperature	°C	-65 to 150

## Thermal Resistance

**Thermal Resistance <sup>[3]</sup>**  
**(V<sub>d</sub> = 5.0V, T<sub>c</sub> = 85°C) θ<sub>jc</sub> = 54.5°C/W**

Notes:

1. Operation of this device in excess of any of these limits may cause permanent damage.
2. Board temperature (T<sub>c</sub>) is 25°C, for T<sub>c</sub> > 105°C derate the device power at 18.3mW/°C rise in board temperature adjacent to package bottom.
3. Thermal resistance measured using Infrared measurement technique.

## MGA-31189 Electrical Specifications <sup>[1]</sup>

T<sub>A</sub> = 25°C, V<sub>d</sub> = 5V, unless noted

Symbol	Parameter and Test Condition	Frequency	Units	Min.	Typ.	Max.
I <sub>ds</sub>	Quiescent current	N/A	mA	93	111	128
NF	Noise Figure	0.45GHz 0.9GHz 1.5GHz	dB	–	2.7 2.0 1.8	2.6
Gain	Gain	0.45GHz 0.9GHz 1.5GHz	dB	19	21 21 20	23
OIP3 <sup>[2]</sup>	Output Third Order Intercept Point	0.45GHz 0.9GHz 1.5GHz	dBm	39.2	41.5 42 41.3	–
P1dB	Output Power at 1dB Gain Compression	0.45GHz 0.9GHz 1.5GHz	dBm	22.3	23.7 24 24.4	–
PAE	Power Added Efficiency at P1dB	0.45GHz 0.9GHz 1.5GHz	%	–	42.7 42.5 44.3	–
IRL	Input Return Loss	0.45GHz 0.9GHz 1.5GHz	dB	–	22.9 15.6 15.9	–
ORL	Output Return Loss	0.45GHz 0.9GHz 1.5GHz	dB	–	10 12.8 16	–
ISOL	Isolation	0.45GHz 0.9GHz 1.5GHz	dB	–	27.9 27.6 27.5	–

Notes:

1. Typical performance obtained from a test circuit described in Figure 34.
2. OIP3 test condition: F1 - F2 = 10MHz, with input power of -12dBm per tone measured at worst case side band.

## MGA-31189 Consistency Distribution Chart (1, 2)

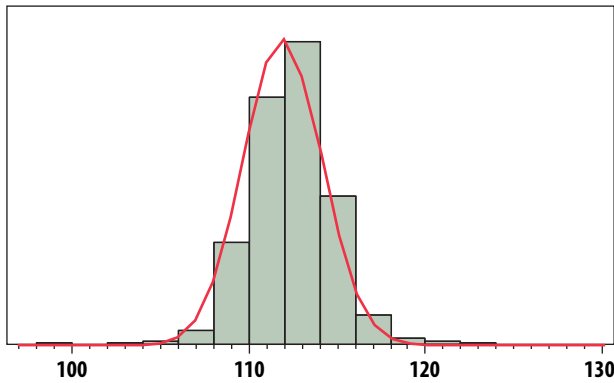

Figure 2. Idd @ 900MHz, Vdd = 5V, LSL=93mA, Nominal=111mA, USL=128mA

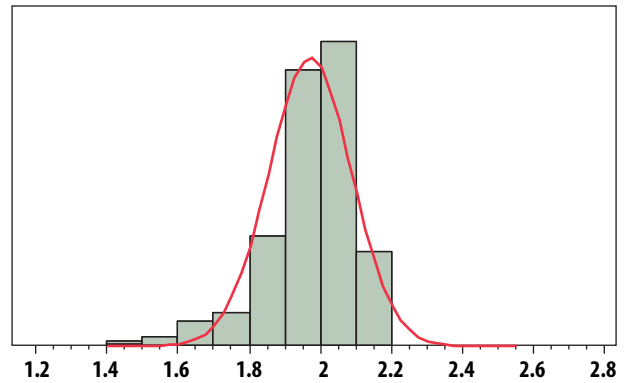

Figure 3. NF @ 900MHz, Vdd = 5V, Nominal=2dB, USL=2.6dB

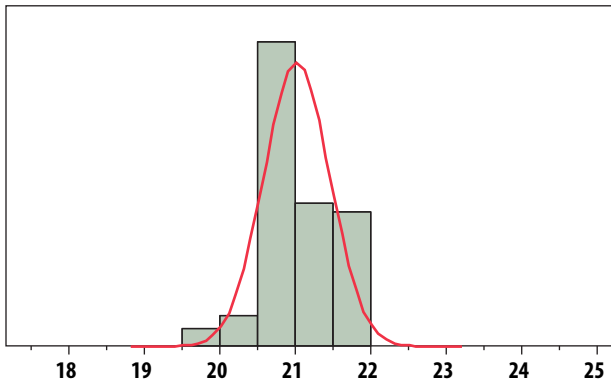

Figure 4. Gain @ 900MHz, Vdd = 5V, LSL=19dB, Nominal=21dB, USL=23dB

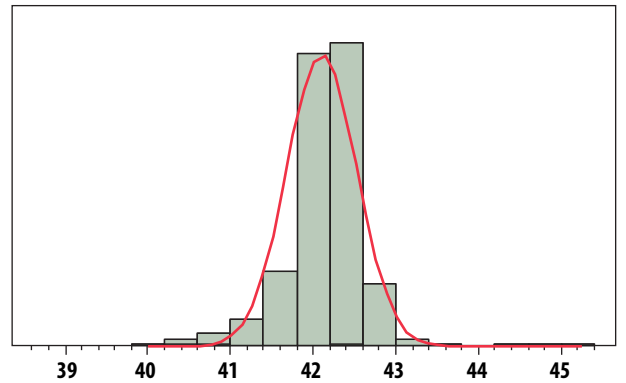

Figure 5. OIP3 @ 900MHz, Vdd = 5V, LSL=39.2dBm, Nominal=42dBm

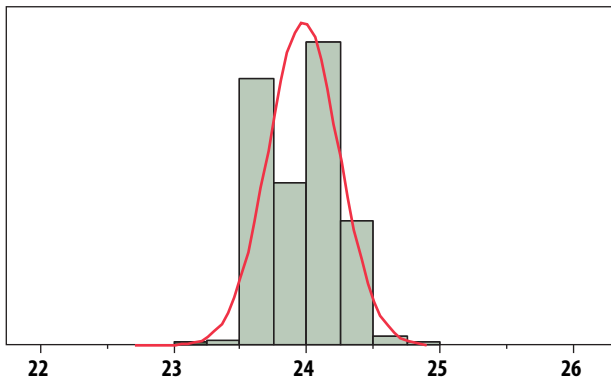

Figure 6. P1dB @ 900MHz, Vdd = 5V, LSL=22.3dBm, Nominal=24dBm

### Notes:

1. Data sample size is 3500 samples taken from 4 different wafers and 2 different lots. Future wafers allocated to this product may have nominal values anywhere between the upper and lower limits.
2. Measurements are made on production test board which represents a trade-off between optimal Gain, NF, OIP3 and OP1dB. Circuit losses have been de-embedded from actual measurements.



# MGA-31189 Application Circuit Data for 450MHz

$T_A = 25^\circ\text{C}$ ,  $V_d = 5.0\text{V}$ ,  $I_d = 111\text{mA}$

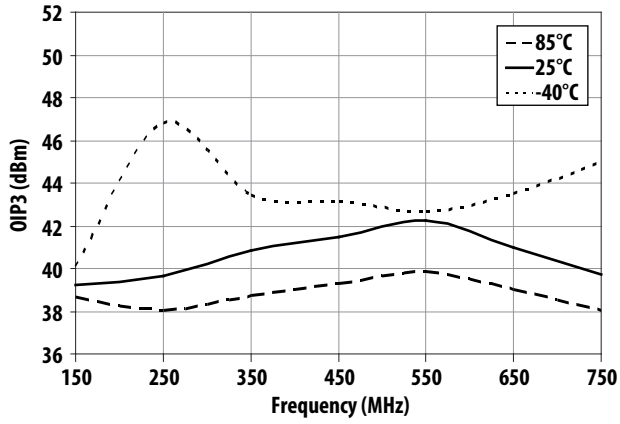

Figure 7. OIP3 vs Frequency and Temperature

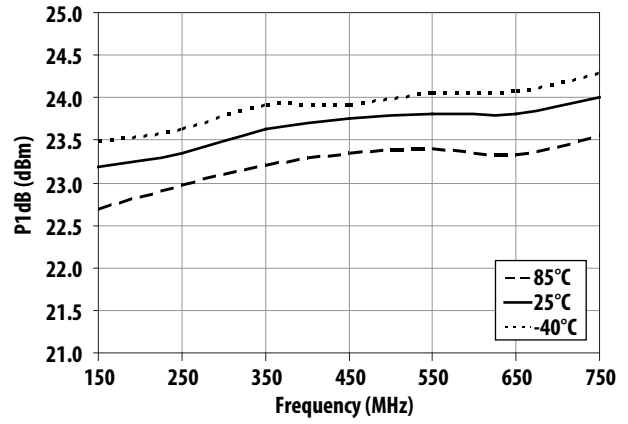

Figure 8. P1dB vs Frequency and Temperature

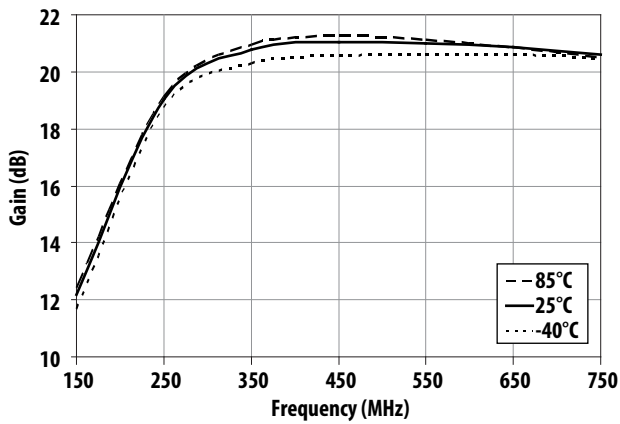

Figure 9. Gain vs Frequency and Temperature

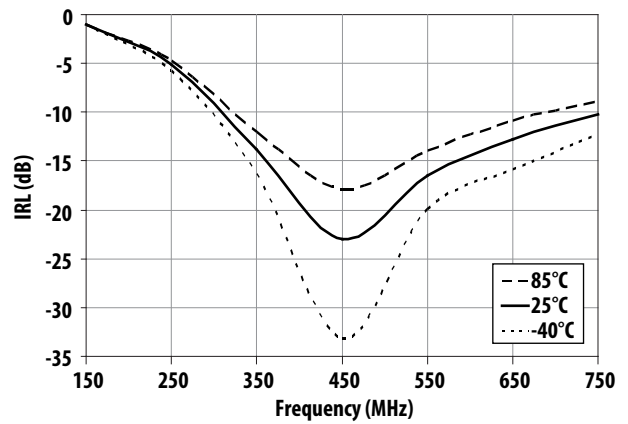

Figure 10. IRL vs Frequency and Temperature

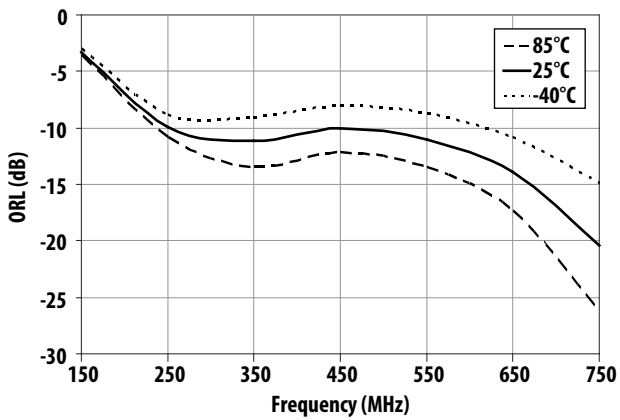

Figure 11. ORL vs Frequency and Temperature

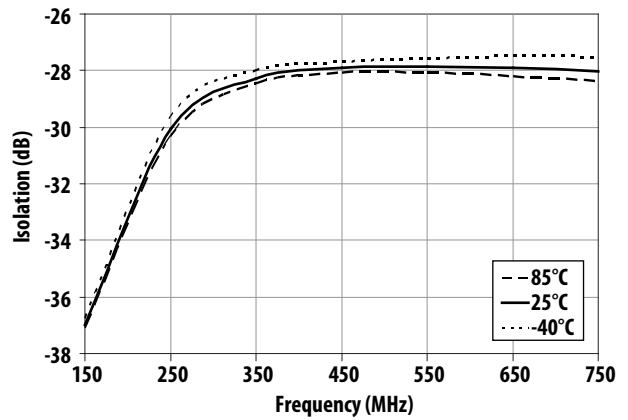

Figure 12. Isolation vs Frequency and Temperature

**MGA-31189 Application Circuit Data for 450MHz** (continue)

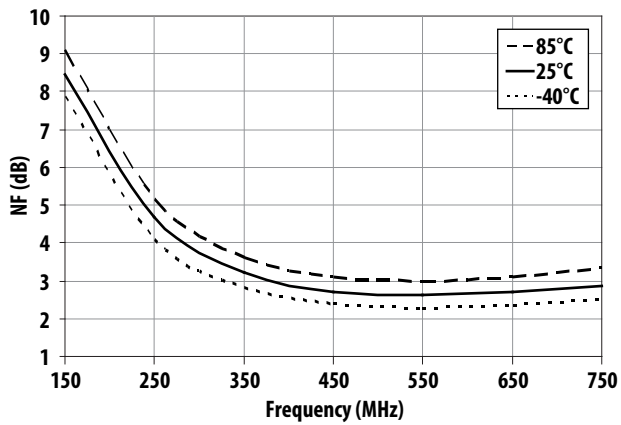

Figure 13. Noise Figure vs Frequency and Temperature

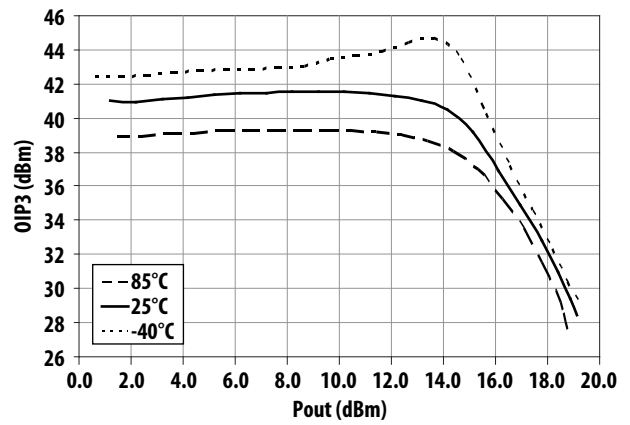

Figure 14. OIP3 vs Output Power and Temperature at 450MHz

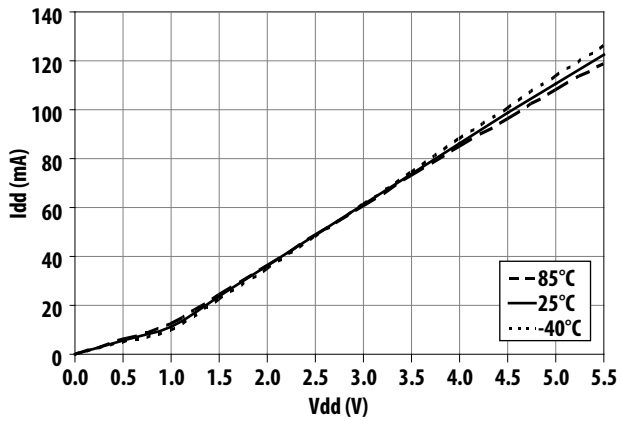

Figure 15. Current vs Voltage and Temperature

# MGA-31189 Application Circuit Data for 900MHz

$T_A = 25^\circ\text{C}$ ,  $V_d = 5.0\text{V}$ ,  $I_d = 111\text{mA}$

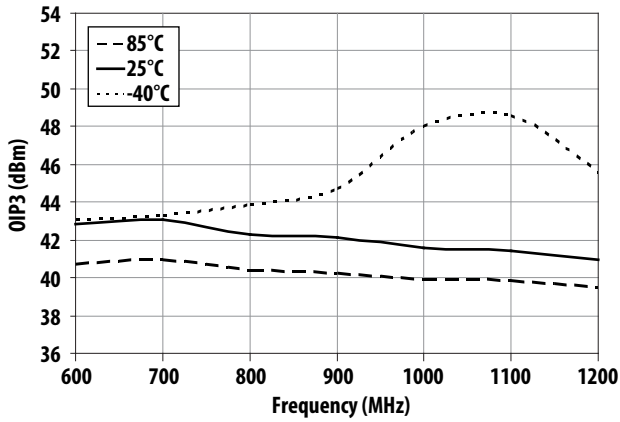

Figure 16. OIP3 vs Frequency and Temperature

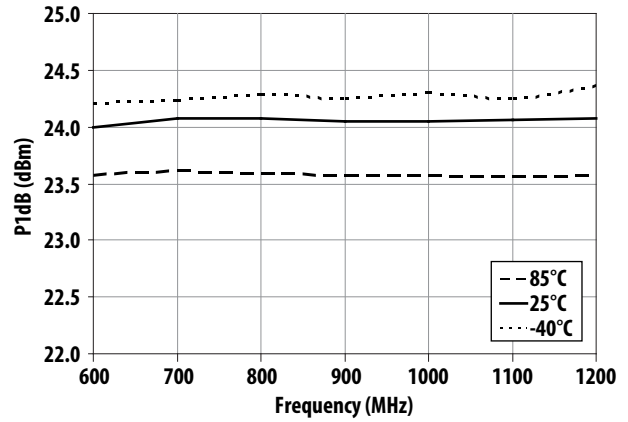

Figure 17. P1dB vs Frequency and Temperature

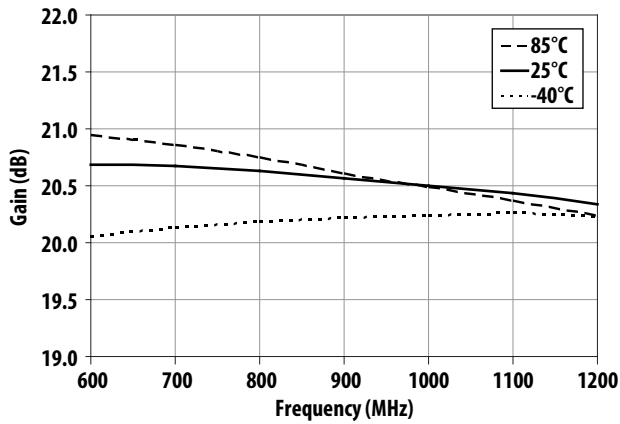

Figure 18. Gain vs Frequency and Temperature

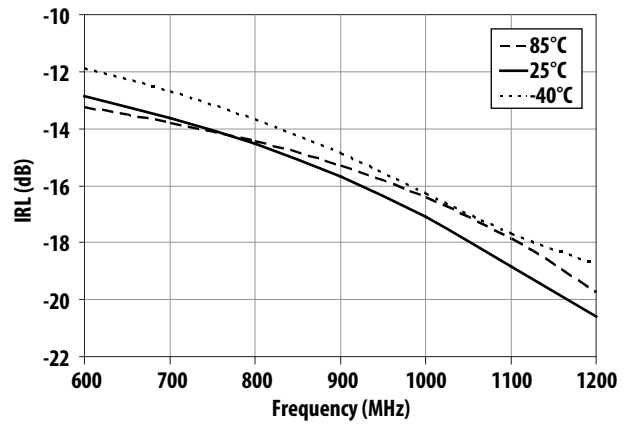

Figure 19. IRL vs Frequency and Temperature

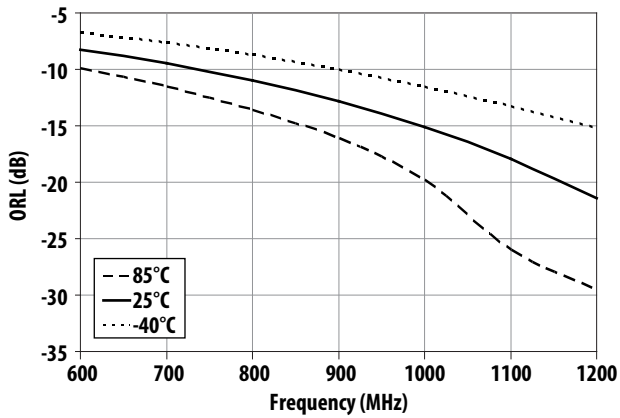

Figure 20. ORL vs Frequency and Temperature

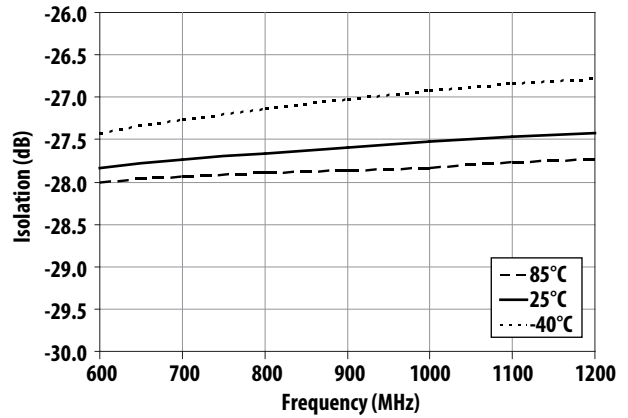

Figure 21. Isolation vs Frequency and Temperature

**MGA-31189 Application Circuit Data for 900MHz** (continue)

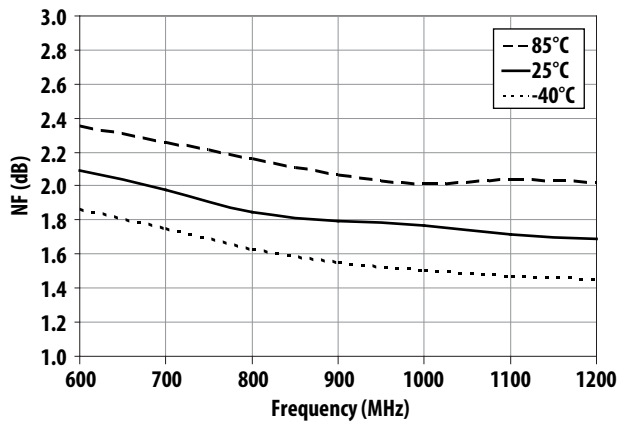

Figure 22. Noise Figure vs Frequency and Temperature

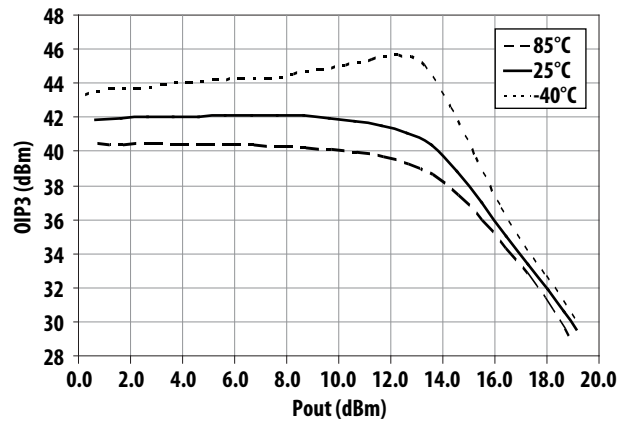

Figure 23. OIP3 vs Output Power and Temperature at 900MHz

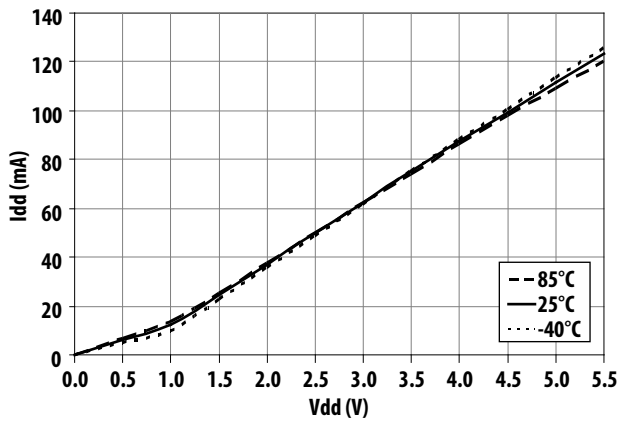

Figure 24. Current vs Voltage and Temperature



# MGA-31189 Application Circuit Data for 1500MHz

$T_A = 25^\circ\text{C}$ ,  $V_d = 5.0\text{V}$ ,  $I_d = 111\text{mA}$

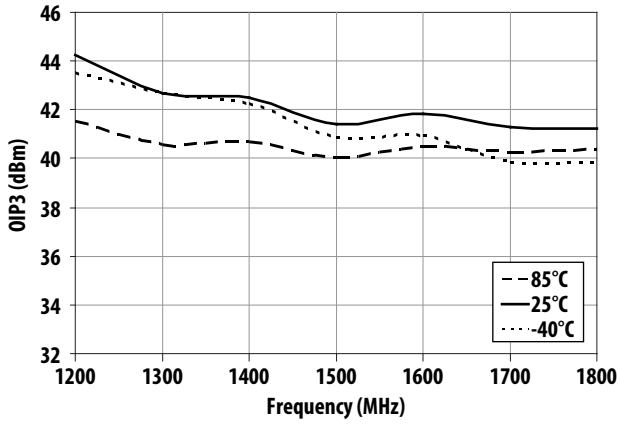

Figure 25. OIP3 vs Frequency and Temperature

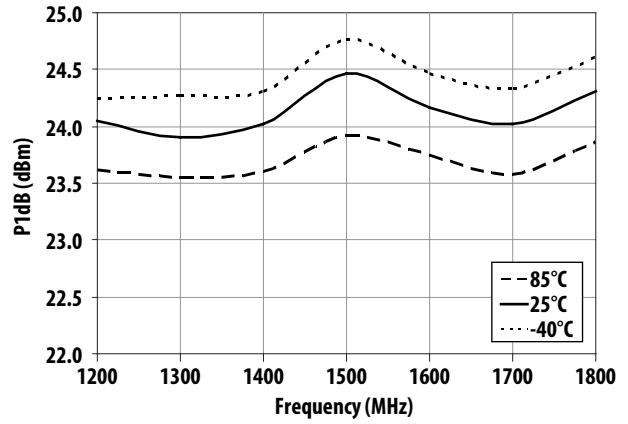

Figure 26. P1dB vs Frequency and Temperature

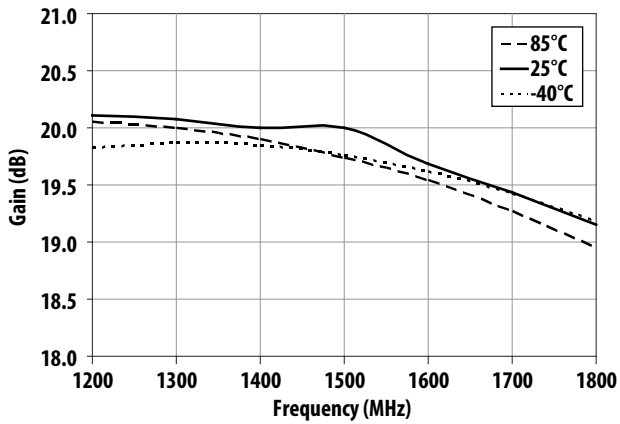

Figure 27. Gain vs Frequency and Temperature

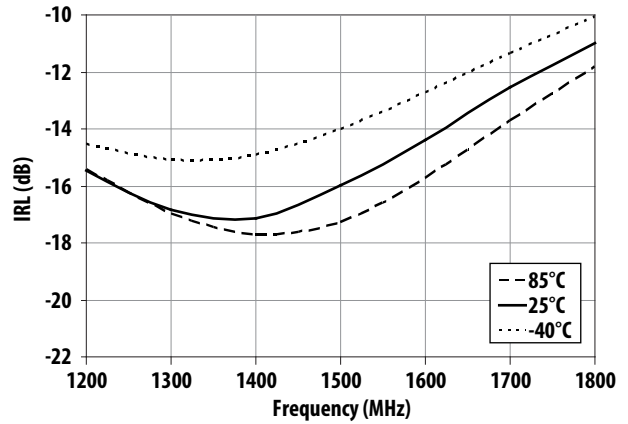

Figure 28. IRL vs Frequency and Temperature

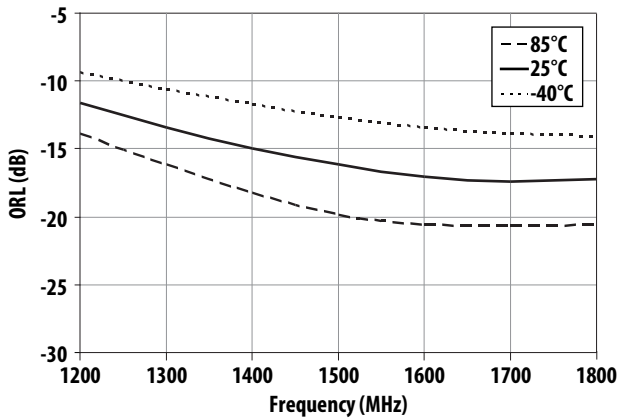

Figure 29. ORL vs Frequency and Temperature

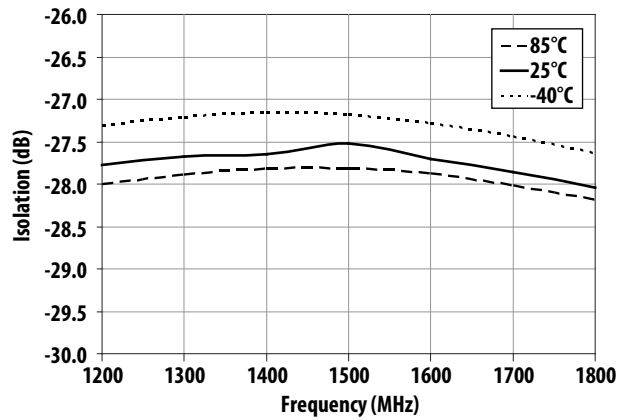

Figure 30. Isolation vs Frequency and Temperature

**MGA-31189 Application Circuit Data for 1500MHz (continue)**

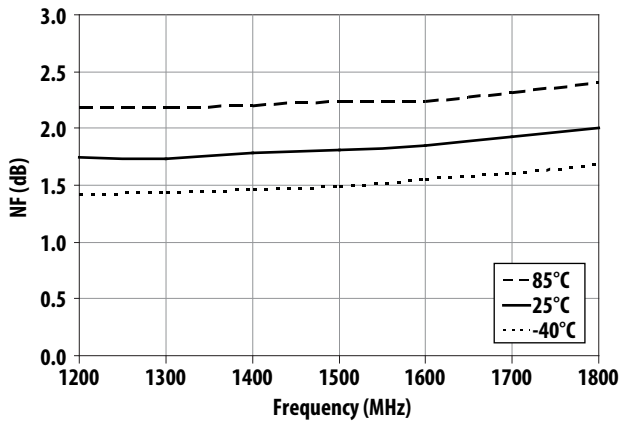

Figure 31. Noise Figure vs Frequency and Temperature

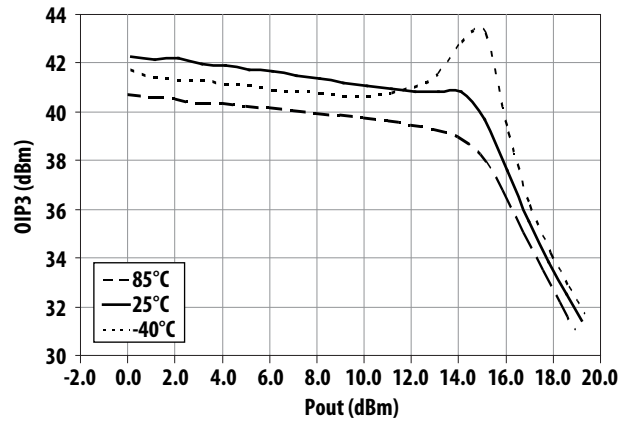

Figure 32. OIP3 vs Output Power and Temperature at 1500MHz

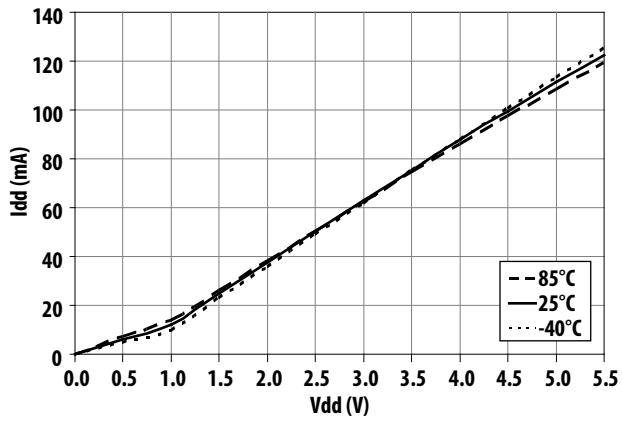

Figure 33. Current vs Voltage and Temperature

## Application Circuit Description and Layout

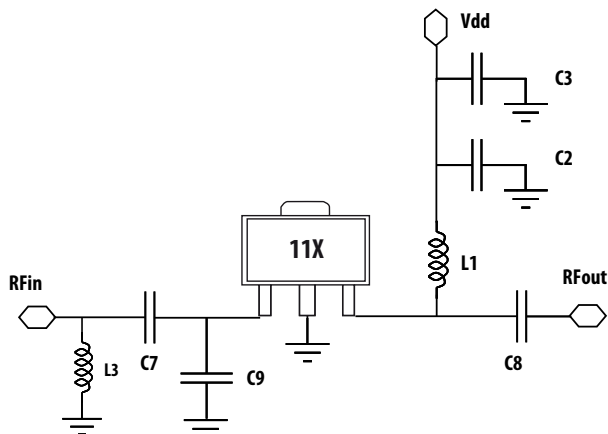

Figure 34. Circuit diagram

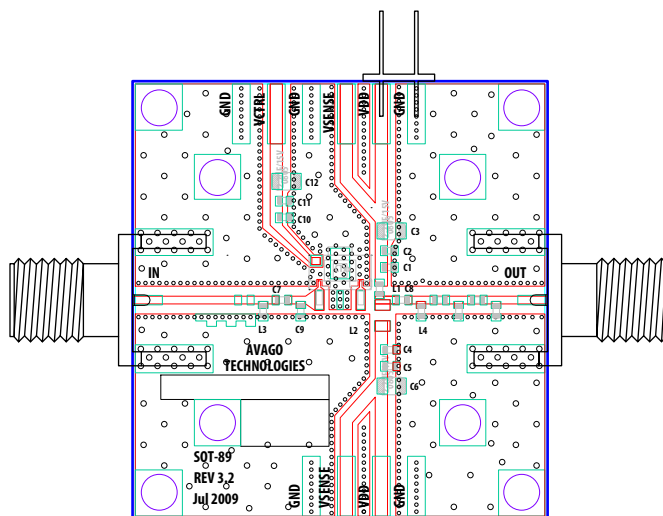

Figure 35. Demoboard

## Bill of Materials

Circuit Symbol	Size	Description					
		For 0.45GHz <sup>(1)</sup>		For 0.9GHz <sup>(2)</sup>		For 1.5GHz <sup>(3)</sup>	
		Value	Manufacturer	Value	Manufacturer	Value	Manufacturer
C2	0402	0.1μF	Murata	0.1μF	Murata	0.1μF	Murata
C3	0603	2.2μF	Murata	2.2μF	Murata	2.2μF	Murata
C7	0402	18pF	Murata	100pF	Murata	100pF	Murata
C8	0402	82pF	Murata	39pF	Murata	100pF	Murata
C9	0402	5.6pF	Murata	NA	NA	NA	NA
L1	0402	56nH	Coilcraft	39nH	Murata	12nH	Murata
L3	0402	18nH	Coilcraft	NA	NA	NA	NA

Note: NA – not required in actual PCB design

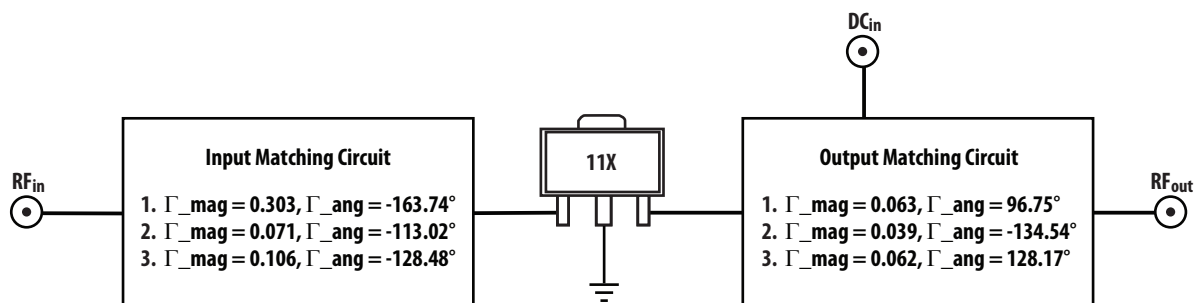

Figure 36. Input and output tuned Gamma location for 450MHz<sup>(1)</sup>, 900MHz<sup>(2)</sup> and 1.5GHz<sup>(3)</sup>

MGA-31189 is an input and output prematched component. To bias MGA-31189, a +5V supply (Vdd) is connected to the output pin thru a RF choke, L1 (which isolates the inband signal from the DC supply). The bypass capacitors, C3 and C2 help to eliminate out of low band frequency signals from the power supply. Blocking capacitors are required for its input (C7) and output (C8), to isolate the supply voltage from succeeding circuits. To improve on input match at 450MHz, L3 and C9 are added. The L1, together with C8 also act as the output tuning circuitry. The recommended output tuning is for achieving best OIP3, while meeting typical specifications for other parameters.

## MGA-31189 Typical Scatter Parameters<sup>(1)</sup>

T<sub>A</sub> = 25°C, V<sub>d</sub> = 5.0V, I<sub>d</sub> = 111mA, Z<sub>o</sub> = 50Ω

Freq GHz	S11			S21			S12			S22			K
	Mag.	Ang.	dB	Mag.	Ang.	dB	Mag.	Ang.	dB	Mag.	Ang.	dB	
0.05	0.229	-146.8	-12.8	12.340	163.1	21.8	0.040	5.0	-28.0	0.499	-172.1	-6.0	1.041
0.10	0.217	-161.0	-13.3	11.850	163.6	21.5	0.040	0.0	-27.9	0.494	178.8	-6.1	1.081
0.20	0.217	-172.7	-13.3	11.590	158.1	21.3	0.041	-6.2	-27.8	0.483	167.7	-6.3	1.104
0.30	0.221	-179.8	-13.1	11.480	150.5	21.2	0.041	-11.5	-27.7	0.465	159.1	-6.7	1.122
0.40	0.225	173.9	-13.0	11.390	142.3	21.1	0.041	-16.7	-27.7	0.438	151.7	-7.2	1.142
0.50	0.226	167.0	-12.9	11.300	133.9	21.1	0.042	-21.9	-27.6	0.406	145.2	-7.8	1.163
0.60	0.223	158.5	-13.1	11.210	125.2	21.0	0.042	-27.3	-27.5	0.370	139.3	-8.6	1.185
0.70	0.218	148.4	-13.2	11.100	116.4	20.9	0.042	-32.8	-27.5	0.335	134.8	-9.5	1.205
0.80	0.214	136.1	-13.4	10.980	107.5	20.8	0.042	-38.6	-27.5	0.303	132.1	-10.4	1.224
0.90	0.213	121.8	-13.4	10.840	98.4	20.7	0.042	-44.7	-27.4	0.279	131.1	-11.1	1.242
1.00	0.218	106.2	-13.2	10.670	89.2	20.6	0.042	-51.1	-27.5	0.263	130.9	-11.6	1.259
1.10	0.224	91.9	-13.0	10.480	80.4	20.4	0.042	-57.5	-27.5	0.251	128.3	-12.0	1.277
1.20	0.231	79.0	-12.7	10.310	71.3	20.3	0.042	-63.8	-27.5	0.240	125.9	-12.4	1.294
1.30	0.241	65.7	-12.4	10.120	62.1	20.1	0.042	-70.1	-27.5	0.230	123.6	-12.8	1.314
1.40	0.251	52.2	-12.0	9.912	52.7	19.9	0.042	-76.7	-27.6	0.221	121.5	-13.1	1.338
1.50	0.262	38.3	-11.6	9.675	43.3	19.7	0.041	-83.4	-27.7	0.212	119.3	-13.5	1.367
1.60	0.275	24.2	-11.2	9.412	33.9	19.5	0.041	-90.2	-27.8	0.205	117.1	-13.8	1.402
1.70	0.290	9.9	-10.8	9.125	24.5	19.2	0.040	-97.2	-28.0	0.198	114.6	-14.1	1.445
1.80	0.306	-4.6	-10.3	8.815	15.0	18.9	0.039	-104.3	-28.2	0.193	112.0	-14.3	1.496
1.90	0.324	-19.0	-9.8	8.486	5.6	18.6	0.038	-111.5	-28.4	0.187	109.1	-14.5	1.557
2.00	0.344	-33.4	-9.3	8.139	-3.7	18.2	0.037	-118.7	-28.6	0.183	105.9	-14.7	1.628
2.10	0.367	-47.6	-8.7	7.776	-13.0	17.8	0.036	-126.1	-28.9	0.180	102.3	-14.9	1.710
2.20	0.392	-61.4	-8.1	7.403	-22.2	17.4	0.034	-133.4	-29.3	0.178	98.2	-15.0	1.803
2.30	0.421	-74.9	-7.5	7.023	-31.3	16.9	0.033	-140.8	-29.6	0.177	93.4	-15.1	1.906
2.40	0.453	-87.9	-6.9	6.641	-40.3	16.5	0.032	-148.1	-30.0	0.177	88.0	-15.1	2.017
2.50	0.488	-100.3	-6.2	6.260	-49.2	15.9	0.030	-155.4	-30.4	0.178	81.8	-15.0	2.133
3.00	0.687	-150.3	-3.3	4.472	-91.1	13.0	0.023	169.3	-32.7	0.199	39.7	-14.0	2.647
3.50	0.822	174.9	-1.7	3.082	-128.3	9.8	0.018	138.1	-35.1	0.227	-11.2	-12.9	3.025
4.00	0.882	147.5	-1.1	2.138	-161.5	6.6	0.014	111.6	-36.8	0.278	-60.5	-11.1	3.496
5.00	0.910	101.5	-0.8	1.070	137.8	0.6	0.013	66.7	-37.6	0.467	-136.9	-6.6	4.963
6.00	0.918	58.3	-0.7	0.524	80.9	-5.6	0.014	24.3	-36.8	0.580	164.0	-4.7	7.125
7.00	0.931	21.3	-0.6	0.258	31.9	-11.8	0.014	-13.9	-36.8	0.576	114.2	-4.8	12.313
8.00	0.935	-8.9	-0.6	0.141	-10.4	-17.0	0.013	-44.6	-37.6	0.569	74.3	-4.9	23.268
9.00	0.933	-39.5	-0.6	0.085	-52.0	-21.4	0.011	-71.9	-39.2	0.594	39.7	-4.5	45.258
10.00	0.936	-69.1	-0.6	0.051	-93.7	-25.8	0.008	-96.5	-42.2	0.650	4.1	-3.7	89.931
11.00	0.946	-92.3	-0.5	0.029	-133.1	-30.9	0.004	-103.3	-48.2	0.728	-31.5	-2.8	223.521
12.00	0.954	-108.5	-0.4	0.014	-171.3	-37.1	0.003	-67.6	-51.5	0.799	-61.5	-1.9	434.262
13.00	0.957	-121.0	-0.4	0.007	132.0	-43.7	0.004	-35.1	-48.0	0.844	-86.3	-1.5	466.907
14.00	0.951	-134.7	-0.4	0.005	50.6	-45.3	0.007	-45.1	-43.6	0.866	-110.5	-1.2	332.034
15.00	0.943	-151.9	-0.5	0.008	-23.8	-42.4	0.008	-69.8	-42.4	0.867	-133.5	-1.2	242.204
16.00	0.939	-170.3	-0.5	0.007	-70.9	-43.6	0.005	-92.2	-45.4	0.857	-150.2	-1.3	439.706
17.00	0.943	173.0	-0.5	0.004	-72.5	-47.5	0.003	-78.5	-49.2	0.851	-161.6	-1.4	1046.765
18.00	0.948	159.6	-0.5	0.004	-44.6	-47.7	0.004	-44.6	-48.6	0.835	-174.5	-1.6	994.693
19.00	0.946	149.4	-0.5	0.006	-29.9	-44.5	0.006	-29.4	-45.1	0.813	167.6	-1.8	534.995
20.00	0.931	139.6	-0.6	0.008	-21.8	-41.5	0.008	-18.3	-41.9	0.803	147.2	-1.9	352.978

### MGA-31189 K-Factor (1)

$T_A = 25^\circ\text{C}$ ,  $V_d = 5.0\text{V}$ ,  $I_d = 111\text{mA}$ ,  $Z_o = 50\Omega$

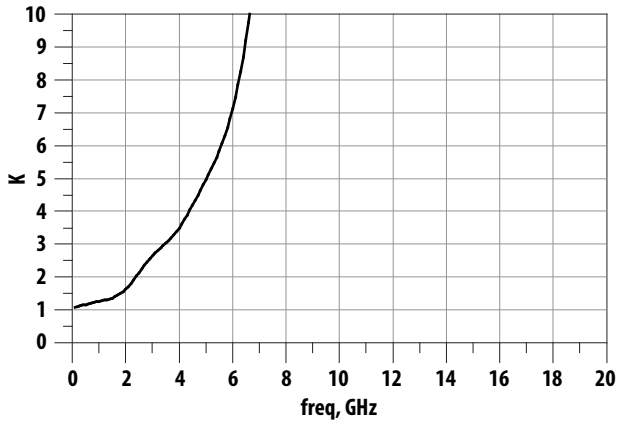

### MGA-31189 Typical Noise Parameters (1)

$T_A = 25^\circ\text{C}$ ,  $V_d = 5.0\text{V}$ ,  $I_d = 111\text{mA}$ ,  $Z_o = 50\Omega$

Freq (GHz)	$F_{min}$ (dB)	$\Gamma_{opt}$ Mag	$\Gamma_{opt}$ Ang	$R_n/Z_o$	Ga (dB)
0.5	2.02	0.112	1.9	0.28	21.89
0.8	1.69	0.132	30.3	0.24	21.28
0.9	1.75	0.153	0.7	0.26	21.04
1	1.79	0.143	5.4	0.26	20.93
1.5	1.77	0.115	83.6	0.21	20.17
2	1.89	0.207	117.5	0.20	19.17
2.5	2.43	0.458	132.2	0.22	18.16
3	2.66	0.670	176.8	0.06	16.20
3.5	3.38	0.772	-166.5	0.10	15.54
4	4.91	0.845	-143.6	0.80	13.85
4.5	7.01	0.889	-123.3	5.86	12.29
5	8.49	0.895	-103.5	10.58	9.57
5.5	9.71	0.892	-79.1	25.29	7.15
6	11.64	0.903	-57.0	56.34	4.63

Note:

1. Measurements are made on 10mils Rogers RO4350 TRL Board.

## Part Number Ordering Information

Part Number	No. of Devices	Container
MGA-31189-BLKG	100	7" Tape/Reel
MGA-31189-TR1G	3000	13" Tape/Reel

## SOT89 Package Dimensions

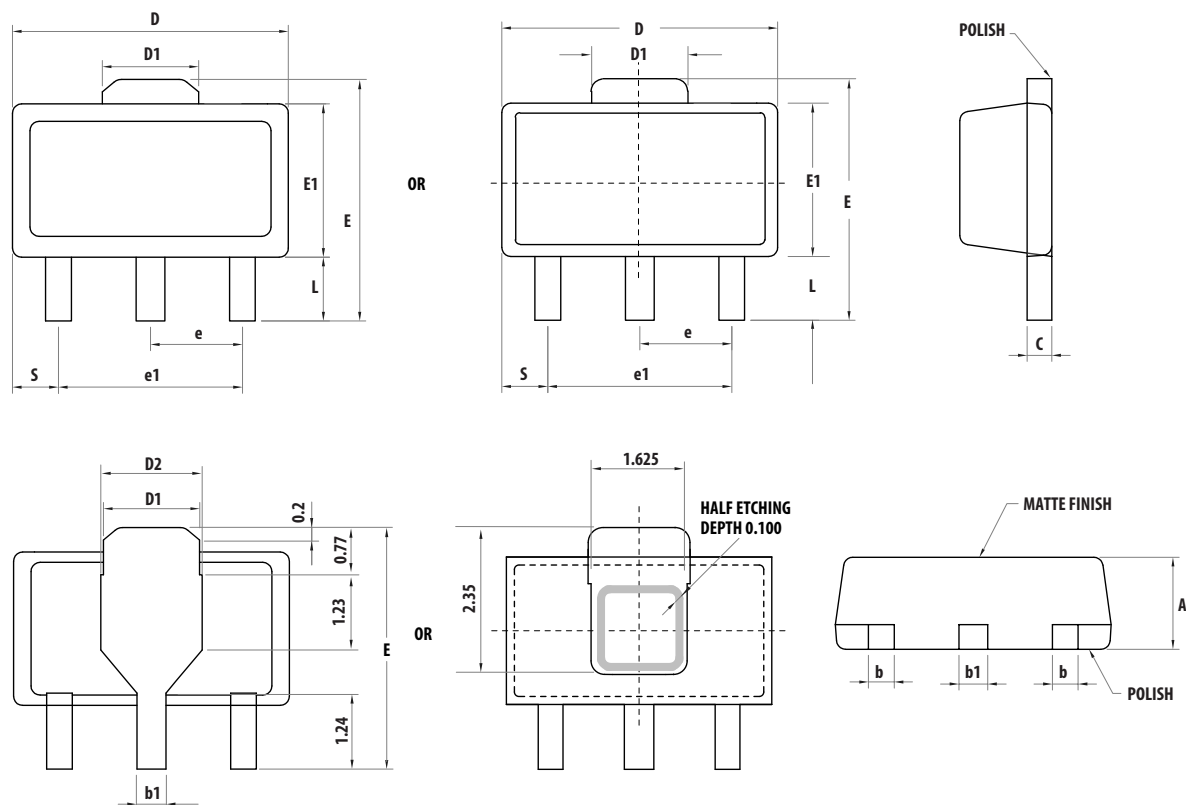

Symbols	Dimensions in mm			Dimensions in inches		
	Minimum	Nominal	Maximum	Minimum	Nominal	Maximum
A	1.40	1.50	1.60	0.055	0.059	0.063
L	0.89	1.04	1.20	0.0350	0.041	0.047
b	0.36	0.42	0.48	0.014	0.016	0.018
b1	0.41	0.47	0.53	0.016	0.018	0.030
C	0.38	0.40	0.43	0.014	0.015	0.017
D	4.40	4.50	4.60	0.173	0.177	0.181
D1	1.40	1.60	1.75	0.055	0.062	0.069
D2	1.45	1.65	1.80	0.055	0.062	0.069
E	3.94	-	4.25	0.155	-	0.167
E1	2.40	2.50	2.60	0.094	0.098	0.102
e1	2.90	3.00	3.10	0.114	0.118	0.122
S	0.65	0.75	0.85	0.026	0.030	0.034
e	1.40	1.50	1.60	0.054	0.059	0.063



## Device Orientation

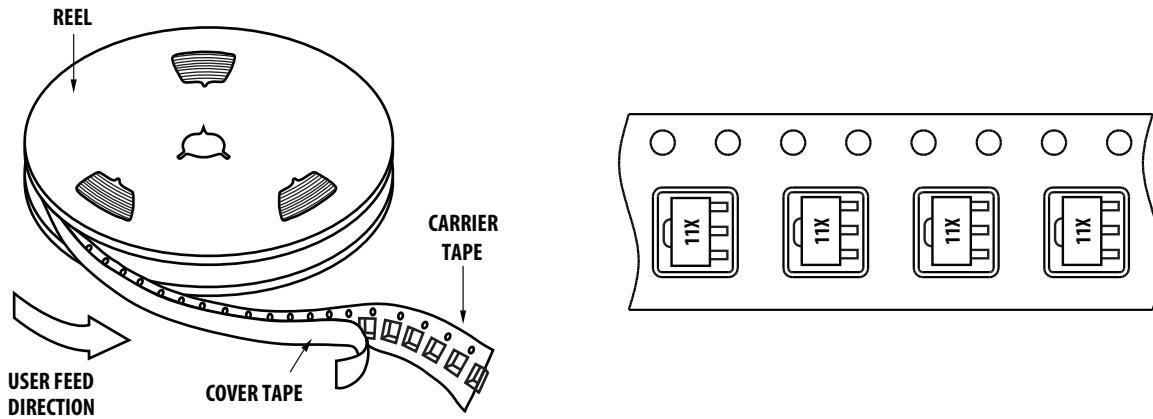

## Tape Dimensions

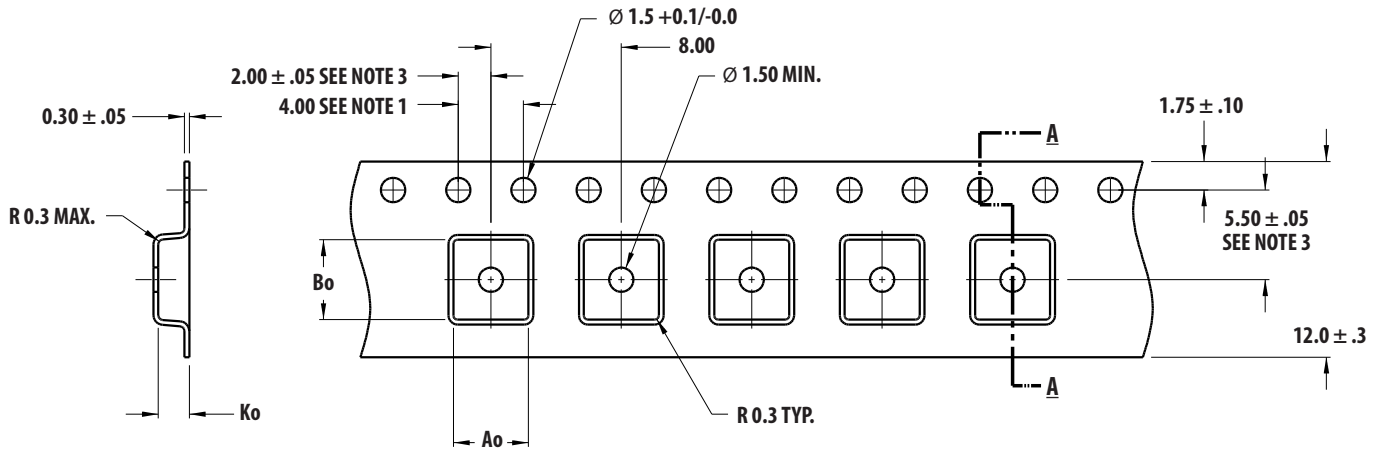

Ao = 4.60  
Bo = 4.90  
Ko = 1.90

DIMENSIONS IN MM

### NOTES:

1. 10 SPROCKET HOLE PITCH CUMULATIVE TOLERANCE  $\pm 0.2$
2. CAMBER IN COMPLIANCE WITH EIA 481
3. POCKET POSITION RELATIVE TO SPROCKET HOLE MEASURED AS TRUE POSITION OF POCKET, NOT POCKET HOLE

# Reel Dimensions – 13" Reel

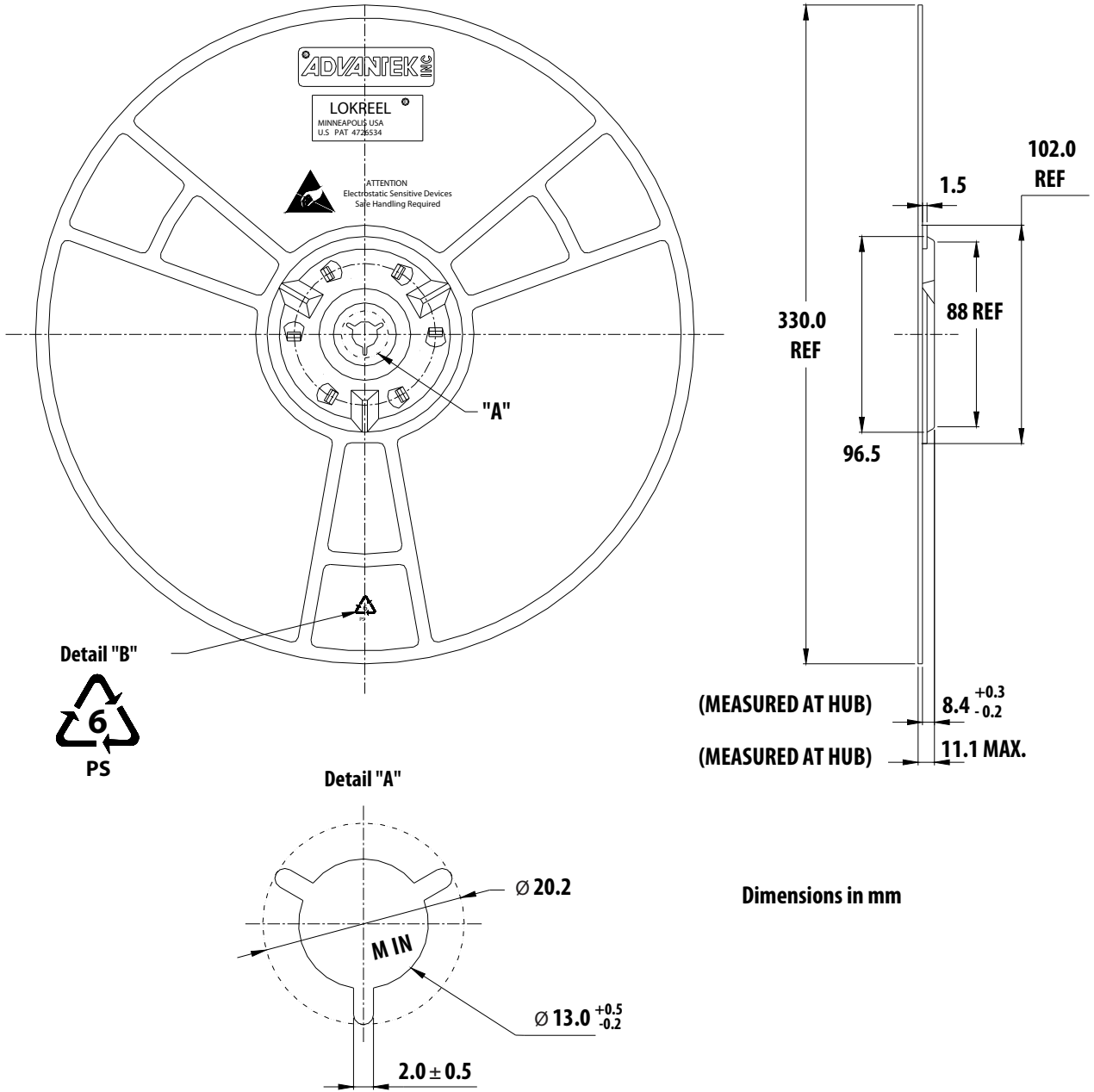

For product information and a complete list of distributors, please go to our web site: [www.avagotech.com](http://www.avagotech.com)

Avago, Avago Technologies, and the A logo are trademarks of Avago Technologies in the United States and other countries. Data subject to change. Copyright © 2005-2012 Avago Technologies. All rights reserved. AV02-2532N - November 11, 2013

