



Chipsmall Limited consists of a professional team with an average of over 10 year of expertise in the distribution of electronic components. Based in Hongkong, we have already established firm and mutual-benefit business relationships with customers from,Europe,America and south Asia,supplying obsolete and hard-to-find components to meet their specific needs.

With the principle of “Quality Parts,Customers Priority,Honest Operation,and Considerate Service”,our business mainly focus on the distribution of electronic components. Line cards we deal with include Microchip,ALPS,ROHM,Xilinx,Pulse,ON,Everlight and Freescale. Main products comprise IC,Modules,Potentiometer,IC Socket,Relay,Connector.Our parts cover such applications as commercial,industrial, and automotives areas.

We are looking forward to setting up business relationship with you and hope to provide you with the best service and solution. Let us make a better world for our industry!



Contact us

Tel: +86-755-8981 8866 Fax: +86-755-8427 6832

Email & Skype: info@chipsmall.com Web: www.chipsmall.com

Address: A1208, Overseas Decoration Building, #122 Zhenhua RD., Futian, Shenzhen, China



MGA-52543

Low Noise Amplifier



Data Sheet

Description

Avago Technologies' MGA-52543 is an economical, easy-to-use GaAs MMIC Low Noise Amplifier (LNA), which is designed for use in LNA and driver stages. While a capable RF/microwave amplifier for any low noise and high linearity 0.4 to 6 GHz application, the LNA focus is Cellular/PCS base stations.

To attain NF_{min} condition, some simple external matching is required. The MGA-52543 features a calculated NF_{min} of 1.61 dB and 15 dB associated gain at 1.9 GHz from a cascode stage, feedback FET amplifier. The input and output are partially matched to be near 50 Ω .

For base station radio card unit LNA application where better than 2:1 VSWR is required, a series inductor on the input and another series inductor on the output can be added externally. The resulting Noise Figure is typically 1.9 dB with 14 dB Gain at 1.9 GHz. With a single 5.0V supply, the LNA typically draws 53 mA. This alignment results in an Input Intercept Point of 17.5 dBm.

The MGA-52543 is a GaAs MMIC, fabricated using Avago Technologies' cost-effective, reliable PHEMT (Pseudomorphic High Electron Mobility Transistor) process. It is housed in the SOT-343 (SC70 4-lead) package. This package offers miniature size (1.2 mm by 2.0 mm), thermal dissipation, and RF characteristics.

Surface Mount Package SOT-343 /4-lead SC70

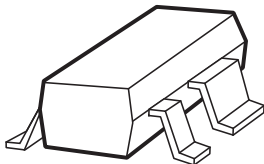

Pin Connections and Package Marking

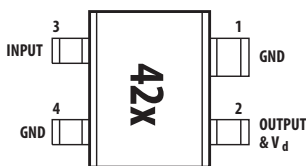

Note:
Top View. Package marking provides orientation and identification.
"42" = Device Code
"x" = Data code character identifies month of manufacture

Features

- Lead-free Option Available
- Operating frequency: 0.4 GHz ~ 6.0 GHz
- Minimum noise figure: 1.61 dB at 1.9 GHz
- Associated gain : 15 dB at 1.9 GHz
- 1.9 GHz performance tuned for VSWR < 2:1
Noise figure: 1.9 dB
Gain: 14 dB
 P_{1dB} : +17.5 dBm
Input IP3: +17.5 dBm
- Single supply 5.0 V operation

Applications

- Cellular/PCS base station radio card LNA
- High dynamic range amplifier for base stations, WLL, WLAN, and other applications



Attention: Observe precautions for handling electrostatic sensitive devices.
ESD Machine Model (Class A)
ESD Human Body Model (Class 1A)
Refer to Avago Application Note A004R: *Electrostatic Discharge Damage and Control.*

Simplified Schematic

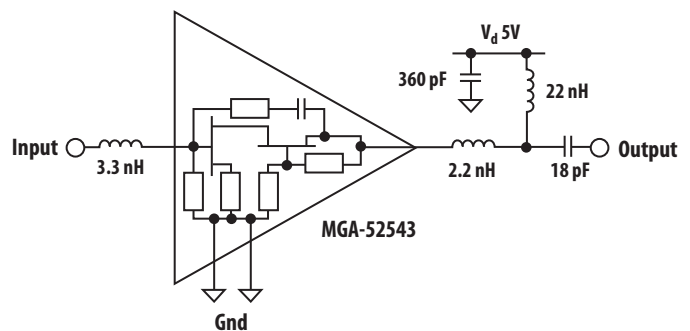

MGA-52543 Absolute Maximum Ratings^[1]

| Symbol | Parameter | Units | Absolute Maximum |
|-----------|------------------------------------|--------------------|------------------|
| V_d | Maximum Input Voltage | V | ± 0.5 |
| V_d | Supply Voltage | V | 7.0 |
| P_d | Power Dissipation ^[2,3] | mW | 425 |
| P_{in} | CW RF Input Power | dBm | +20 |
| T_j | Junction Temperature | $^{\circ}\text{C}$ | 160 |
| T_{STG} | Storage Temperature | $^{\circ}\text{C}$ | -65 to 150 |

Thermal Resistance:^[2]

$$\theta_{jc} = 150^{\circ}\text{C/W}$$

Notes:

1. Operation of this device in excess of any of these limits may cause permanent damage.
2. $T_{case} = 25^{\circ}\text{C}$

Electrical Specifications

$T_c = +25^{\circ}\text{C}$, $Z_0 = 50 \Omega$, $V_d = 5\text{V}$, unless noted

| Symbol | Parameter and Test Condition | Frequency | Units | Min. | Typ. | Max. | σ ^[3] |
|---------------------------|---------------------------------------|--------------------|-------|------|--------------|------|-------------------------|
| I_d test | Current drawn | N/A | mA | 45 | 53 | 70 | 3.57 |
| NF ^[1] | Noise Figure | 1.9 GHz 0.9 GHz | dB | | 1.9 1.8 | 2.3 | 0.15 |
| Gain ^[1] | Gain | 1.9 GHz 0.9 GHz | dB | 13 | 14.2 15 | 15.5 | 0.26 |
| IIP3 ^[1] | Input Third Order Intercept Point | 1.9 GHz 0.9 GHz | dBm | 14 | +17.5 +18 | | 2.28 |
| F_{min} ^[2] | Minimum Noise Figure | 1.9 GHz 0.9 GHz | dB | | 1.6 1.5 | | |
| G_a ^[2] | Associated Gain at F_{min} | 1.9 GHz 0.9 GHz | dB | | 15.0 16.2 | | |
| OIP3 ^[1] | Output Third Order Intercept Point | 1.9 GHz 0.9 GHz | dBm | | 31.7 33.0 | | |
| P_{1dB} ^[1] | Output Power at 1 dB Gain Compression | 1.9 GHz 0.9 GHz | dBm | | +17.4 +18 | | |
| RL_{in} ^[1] | Input Return Loss | 1.9 GHz 0.9 GHz | dB | | 11 15 | | |
| RL_{out} ^[1] | Output Return Loss | 1.9 GHz 0.9 GHz | dB | | 20 22 | | |
| ISOL ^[1] | Isolation $ s_{12} ^2$ | 1.9 GHz 0.9 GHz | dB | | -25 -25 | | |

Notes:

1. Measurements obtained from a fixed narrow band tuning described in Figure 1. This circuit designed to optimize Noise Figure and IIP3 while maintaining VSWR better than 2:1.
2. Minimum Noise Figure and Associated Gain at F_{min} computed from S-parameter and Noise Parameter data measured in an automated NF system.
3. Standard deviation data are based on at least 400 part sample size and 11 wafer lots.

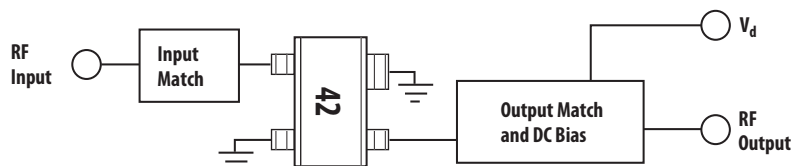

Figure 1. Block Diagram of Test Fixture.

See Figure 7 in the Applications section for an equivalent schematic of 1.9 GHz circuit; Figure 11 in the Applications section for 900 MHz circuit.

MGA-52543 Typical Performance

All data are measured at $T_c = 25^\circ\text{C}$, $V_d = 5\text{V}$, and in the following test system unless stated otherwise.

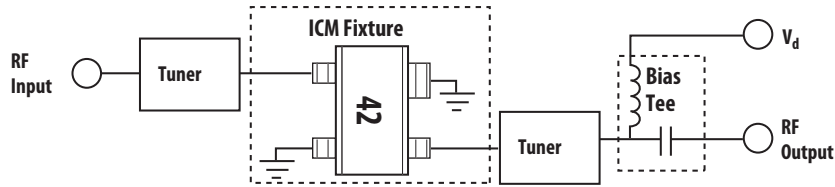

Figure 2. Test Circuit for S, Noise, and Power Parameters over Frequency.

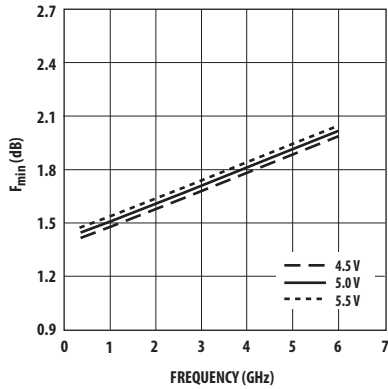

Figure 3. Minimum Noise Figure vs. Frequency and Voltage^[1].

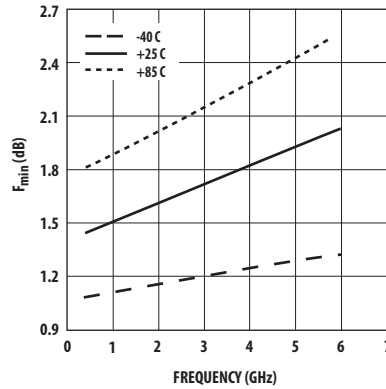

Figure 4. Minimum Noise Figure vs. Frequency and Temperature^[1].

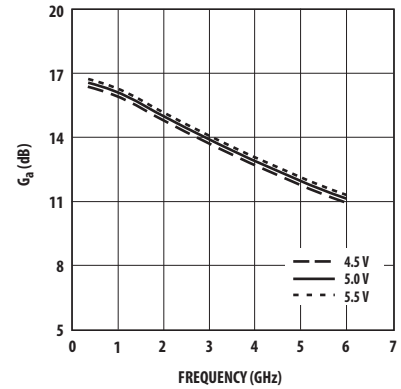

Figure 5. Associated Gain vs. Frequency and Voltage^[1].

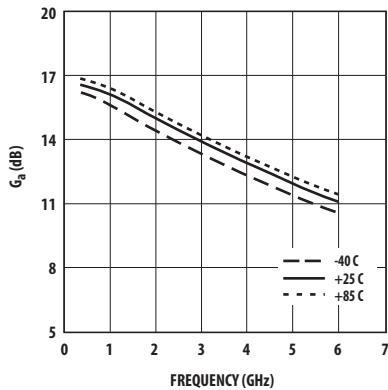

Figure 6. Associated Gain vs. Frequency and Temperature^[1].

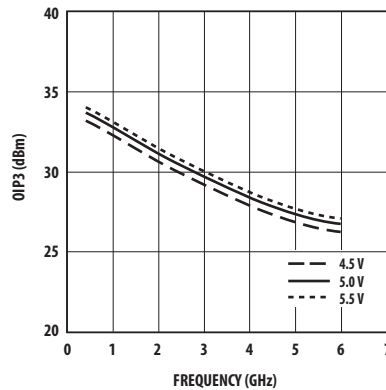

Figure 7. Output Third Order Intercept Point vs. Frequency and Voltage^[2].

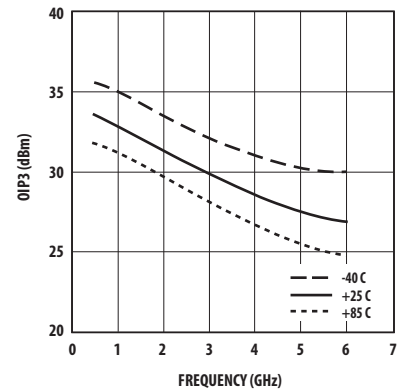

Figure 8. Output Third Order Intercept Point vs. Frequency and Temperature^[2].

Notes:

1. Minimum Noise Figure and Associated Gain at F_{min} computed from S-parameter and Noise Parameter data measured in an automated NF system.
2. Tuners on input and output were set for narrow band tuning designed to optimize NF and OIP3 while keeping VSWRs better than 2:1. See Figure 9 for corresponding return losses at each frequency band.

MGA-52543 Typical Performance, continued

All data are measured at $T_c = 25^\circ\text{C}$, $V_d = 5\text{V}$, and in the following test system unless stated otherwise.

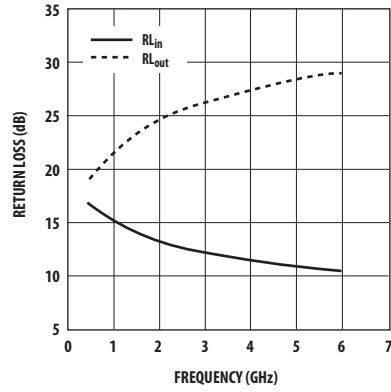

Figure 9. Return Losses at each Narrow Band Tuning.

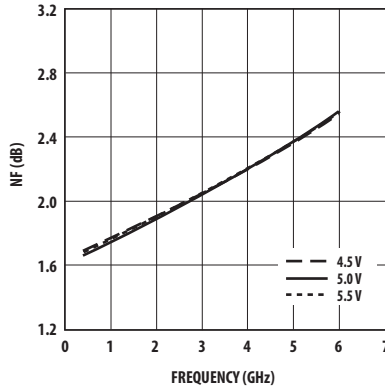

Figure 10. Noise Figure vs. Frequency and Voltage.

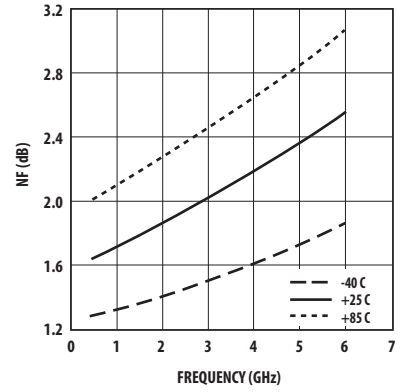

Figure 11. Noise Figure vs. Frequency and Temperature.

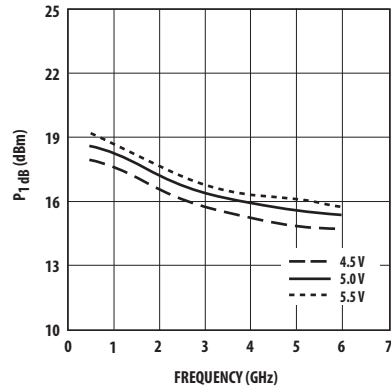

Figure 12. Output Power at 1 dB Compression vs. Frequency and Voltage.

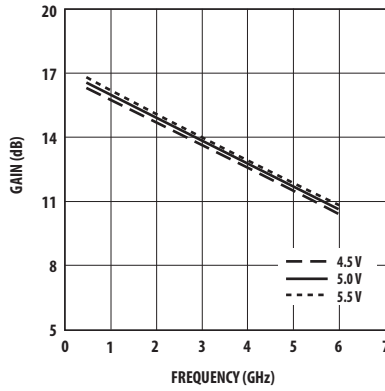

Figure 13. Gain vs. Frequency and Voltage.

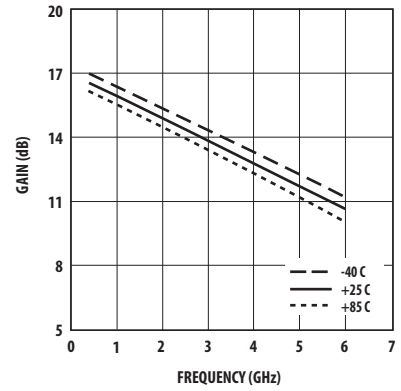

Figure 14. Gain vs. Frequency and Temperature.

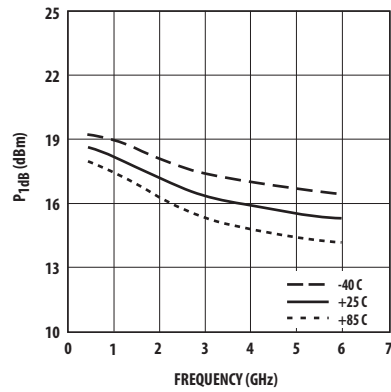

Figure 15. Output Power at 1 dB Compression vs. Frequency and Temperature.

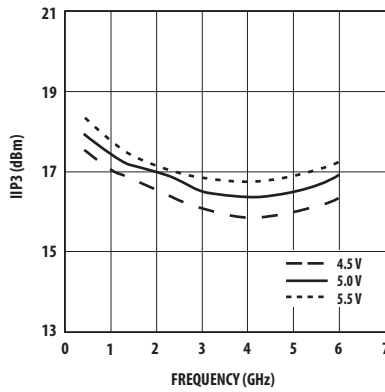

Figure 16. Input Third Order Intercept Point vs. Frequency and Voltage.

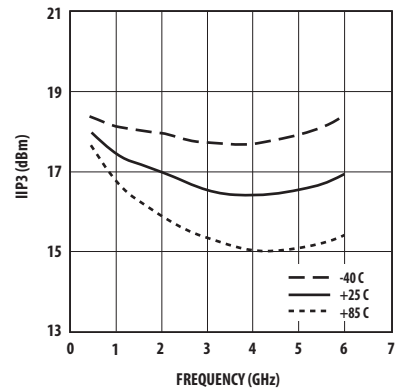

Figure 17. Input Third Order Intercept Point vs. Frequency and Temperature.

Note:

All data reported from Figures 7 through 17 using test setup described in Figure 2. Tuners on input and output were set for narrow band tuning designed to optimize NF and OIP3 while keeping VSWRs better than 2:1. See Figure 9 for corresponding return losses at each frequency band.

MGA-52543 Typical Performance, continued

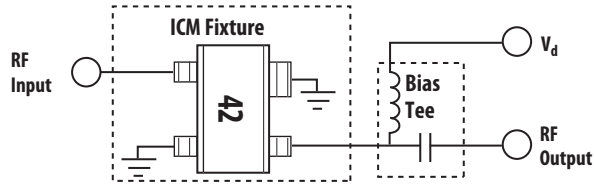

Figure 18. Test Circuit for Figures 19 through 24 (Input and Output presented to 50Ω).

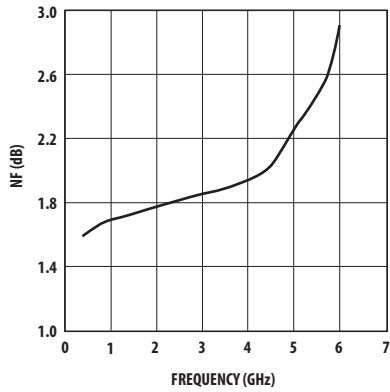

Figure 19. Noise Figure vs. Frequency

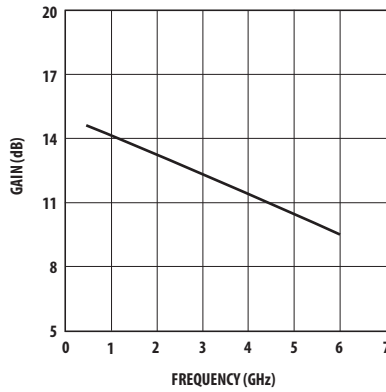

Figure 20. Gain vs. Frequency.

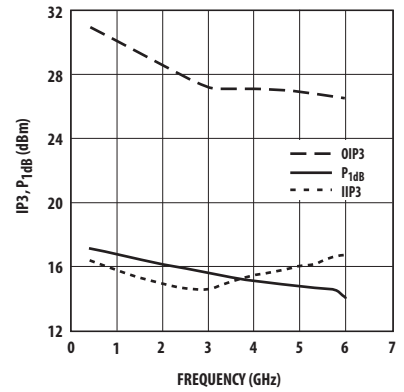

Figure 21. Input IP3, Output IP3 and P_{1dB} vs. Frequency.

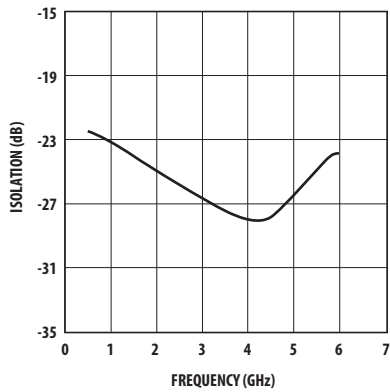

Figure 22. Isolation vs. Frequency.

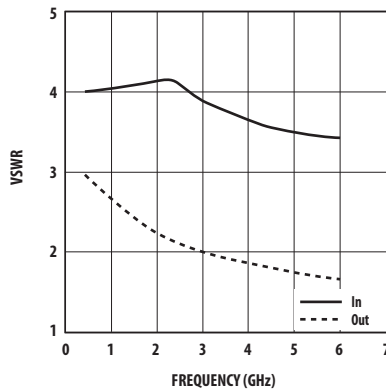

Figure 23. Input and Output VSWR vs. Frequency.

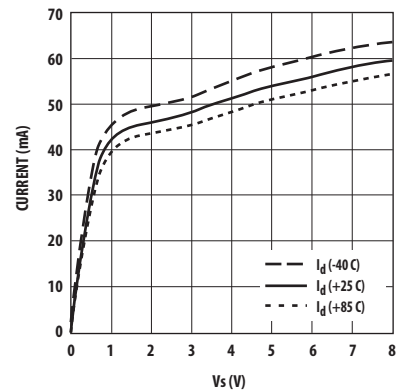

Figure 24. Current vs. V_d.

MGA-52543 Typical Scattering Parameters

$T_c = 25^\circ\text{C}$, $V_d = 5.0\text{V}$, $I_d = 53\text{ mA}$, $Z_0 = 50\ \Omega$, (from S and Noise Parameters in ICM test fixture)

| Freq | s_{11} (m) | s_{11} (a) | s_{21} (dB) | s_{21} (m) | s_{21} (a) | s_{12} (dB) | s_{12} (m) | s_{12} (a) | s_{22} (m) | s_{22} (a) | K |
|------|--------------|--------------|---------------|--------------|--------------|---------------|--------------|--------------|--------------|--------------|------|
| 0.2 | 0.64 | -17.42 | 14.92 | 5.57 | 168.30 | -22.90 | 0.072 | 16.89 | 0.53 | -14.49 | 1.00 |
| 0.3 | 0.62 | -18.44 | 14.76 | 5.47 | 166.18 | -22.62 | 0.074 | 9.26 | 0.51 | -15.38 | 1.04 |
| 0.4 | 0.61 | -20.41 | 14.67 | 5.41 | 163.57 | -22.56 | 0.074 | 4.62 | 0.51 | -17.35 | 1.06 |
| 0.5 | 0.60 | -23.21 | 14.60 | 5.37 | 160.09 | -22.58 | 0.074 | 0.54 | 0.49 | -18.04 | 1.08 |
| 0.6 | 0.60 | -26.02 | 14.54 | 5.33 | 156.98 | -22.66 | 0.074 | -2.26 | 0.48 | -20.59 | 1.09 |
| 0.7 | 0.60 | -29.01 | 14.46 | 5.28 | 153.79 | -22.78 | 0.073 | -4.58 | 0.48 | -23.14 | 1.10 |
| 0.8 | 0.60 | -31.88 | 14.37 | 5.23 | 150.67 | -22.92 | 0.071 | -6.59 | 0.47 | -25.89 | 1.12 |
| 0.9 | 0.60 | -35.42 | 14.28 | 5.18 | 147.57 | -23.06 | 0.070 | -8.26 | 0.46 | -28.24 | 1.13 |
| 1 | 0.60 | -38.48 | 14.19 | 5.13 | 144.53 | -23.23 | 0.069 | -9.68 | 0.45 | -31.05 | 1.14 |
| 1.1 | 0.60 | -41.81 | 14.10 | 5.07 | 141.44 | -23.40 | 0.068 | -10.91 | 0.44 | -33.35 | 1.16 |
| 1.2 | 0.61 | -45.23 | 14.01 | 5.02 | 138.48 | -23.58 | 0.066 | -12.02 | 0.44 | -35.96 | 1.17 |
| 1.3 | 0.61 | -48.69 | 13.92 | 4.96 | 135.50 | -23.76 | 0.065 | -13.01 | 0.43 | -38.26 | 1.19 |
| 1.4 | 0.61 | -52.14 | 13.82 | 4.91 | 132.59 | -23.95 | 0.063 | -13.77 | 0.42 | -40.57 | 1.21 |
| 1.5 | 0.61 | -55.73 | 13.73 | 4.86 | 129.67 | -24.14 | 0.062 | -14.46 | 0.41 | -42.72 | 1.22 |
| 1.6 | 0.61 | -59.22 | 13.63 | 4.80 | 126.78 | -24.34 | 0.061 | -15.00 | 0.41 | -44.90 | 1.25 |
| 1.7 | 0.61 | -62.73 | 13.54 | 4.75 | 123.96 | -24.53 | 0.059 | -15.44 | 0.40 | -46.95 | 1.27 |
| 1.8 | 0.61 | -66.34 | 13.45 | 4.70 | 121.14 | -24.72 | 0.058 | -15.78 | 0.39 | -48.94 | 1.29 |
| 1.9 | 0.61 | -69.85 | 13.36 | 4.66 | 118.37 | -24.93 | 0.057 | -16.07 | 0.39 | -50.92 | 1.32 |
| 2 | 0.61 | -73.41 | 13.27 | 4.61 | 115.53 | -25.10 | 0.056 | -16.19 | 0.38 | -52.95 | 1.34 |
| 2.1 | 0.61 | -76.93 | 13.19 | 4.57 | 112.76 | -25.29 | 0.054 | -16.23 | 0.37 | -54.81 | 1.36 |
| 2.2 | 0.61 | -80.55 | 13.10 | 4.52 | 109.97 | -25.48 | 0.053 | -16.15 | 0.37 | -56.73 | 1.39 |
| 2.3 | 0.61 | -84.18 | 13.02 | 4.48 | 107.22 | -25.69 | 0.052 | -16.20 | 0.36 | -58.62 | 1.42 |
| 2.4 | 0.61 | -87.95 | 12.95 | 4.44 | 104.46 | -25.88 | 0.051 | -16.12 | 0.36 | -60.36 | 1.46 |
| 2.5 | 0.60 | -91.46 | 12.87 | 4.40 | 101.71 | -26.04 | 0.050 | -15.93 | 0.35 | -62.11 | 1.48 |
| 3 | 0.59 | -109.93 | 12.46 | 4.20 | 88.05 | -26.89 | 0.045 | -13.42 | 0.33 | -69.84 | 1.66 |
| 3.5 | 0.58 | -128.36 | 12.02 | 3.99 | 74.65 | -27.67 | 0.041 | -8.35 | 0.32 | -76.05 | 1.89 |
| 4 | 0.57 | -146.55 | 11.56 | 3.79 | 61.39 | -28.07 | 0.040 | -0.44 | 0.30 | -81.51 | 2.08 |
| 4.5 | 0.56 | -164.07 | 11.10 | 3.59 | 48.43 | -27.72 | 0.041 | 9.10 | 0.29 | -87.17 | 2.11 |
| 5 | 0.55 | 179.17 | 10.60 | 3.39 | 35.70 | -26.66 | 0.046 | 16.13 | 0.28 | -93.37 | 1.99 |
| 5.5 | 0.55 | 163.86 | 10.09 | 3.19 | 23.34 | -25.28 | 0.054 | 19.97 | 0.26 | -101.07 | 1.81 |
| 6 | 0.55 | 148.85 | 9.58 | 3.01 | 11.08 | -23.76 | 0.065 | 20.39 | 0.25 | -111.19 | 1.62 |
| 6.5 | 0.56 | 134.84 | 9.01 | 2.82 | -0.85 | -22.33 | 0.076 | 17.75 | 0.24 | -124.51 | 1.48 |
| 7 | 0.57 | 121.13 | 8.44 | 2.64 | -12.44 | -21.13 | 0.088 | 13.58 | 0.23 | -137.46 | 1.38 |
| 7.5 | 0.58 | 108.36 | 7.85 | 2.47 | -23.66 | -20.03 | 0.100 | 9.01 | 0.23 | -151.87 | 1.30 |
| 8 | 0.58 | 95.90 | 7.25 | 2.31 | -34.68 | -19.00 | 0.112 | 3.27 | 0.24 | -165.58 | 1.22 |

Noise Parameters

| Freq (GHz) | F_{\min} (dB) | Γ_{opt} Mag | Γ_{opt} Ang | R_n/Z_0 | G_a (dB) |
|------------|-----------------|---------------------------|---------------------------|-----------|------------|
| 0.5 | 1.46 | 0.32 | 10.51 | 0.37 | 16.5 |
| 0.8 | 1.49 | 0.31 | 21.95 | 0.35 | 16.3 |
| 0.9 | 1.50 | 0.31 | 28.21 | 0.34 | 16.19 |
| 1 | 1.51 | 0.3 | 32.89 | 0.34 | 16.1 |
| 1.1 | 1.52 | 0.3 | 39.85 | 0.33 | 16.0 |
| 1.5 | 1.57 | 0.29 | 45.05 | 0.30 | 15.61 |
| 1.8 | 1.60 | 0.28 | 50.05 | 0.28 | 15.2 |
| 1.9 | 1.61 | 0.28 | 57.75 | 0.27 | 15.02 |
| 2 | 1.62 | 0.27 | 59.67 | 0.27 | 14.9 |
| 2.1 | 1.63 | 0.27 | 63.12 | 0.26 | 14.8 |
| 2.2 | 1.64 | 0.26 | 64.28 | 0.26 | 14.65 |
| 2.3 | 1.65 | 0.26 | 68.3 | 0.25 | 14.58 |
| 2.4 | 1.66 | 0.25 | 75.25 | 0.24 | 14.48 |
| 2.5 | 1.68 | 0.25 | 78.03 | 0.24 | 14.39 |
| 3 | 1.73 | 0.23 | 94.06 | 0.21 | 13.98 |
| 3.5 | 1.78 | 0.21 | 121.52 | 0.18 | 13.39 |
| 4 | 1.84 | 0.2 | 141.87 | 0.16 | 12.9 |
| 4.5 | 1.89 | 0.21 | 172.98 | 0.15 | 12.45 |
| 5 | 1.94 | 0.24 | -169.13 | 0.14 | 12 |
| 5.5 | 2.00 | 0.28 | -146.48 | 0.16 | 11.59 |
| 6 | 2.05 | 0.31 | -133.04 | 0.19 | 11.1 |

Package Dimensions
Outline 43
SOT-343 (SC70 4-lead)

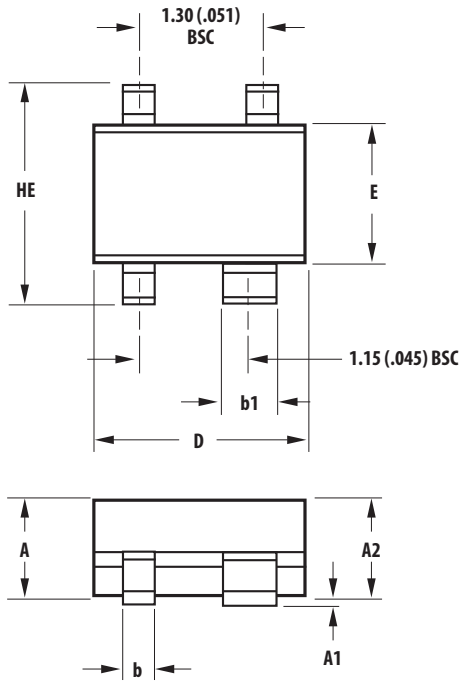

| SYMBOL | DIMENSIONS (mm) | |
|--------|-----------------|------|
| | MIN. | MAX. |
| E | 1.15 | 1.35 |
| D | 1.85 | 2.25 |
| HE | 1.80 | 2.40 |
| A | 0.80 | 1.10 |
| A2 | 0.80 | 1.00 |
| A1 | 0.00 | 0.10 |
| b | 0.15 | 0.40 |
| b1 | 0.55 | 0.70 |
| c | 0.10 | 0.20 |
| L | 0.10 | 0.46 |

Recommended PCB Pad Layout for
Avago's SC70 4L/SOT-343 Products

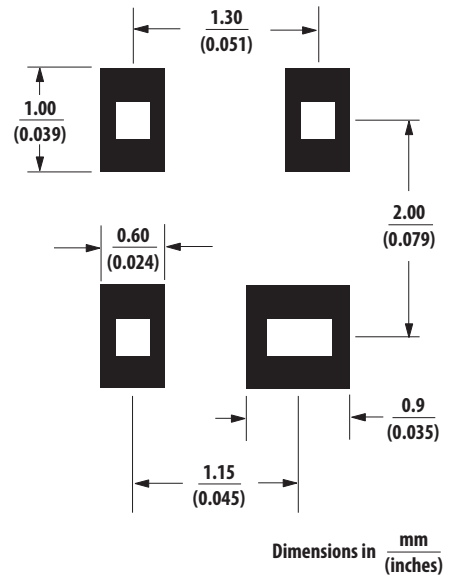

- NOTES:**
1. All dimensions are in mm.
 2. Dimensions are inclusive of plating.
 3. Dimensions are exclusive of mold flash & metal burr.
 4. All specifications comply to EIAJ SC70.
 5. Die is facing up for mold and facing down for trim/form, ie: reverse trim/form.
 6. Package surface to be mirror finish.

Device Orientation

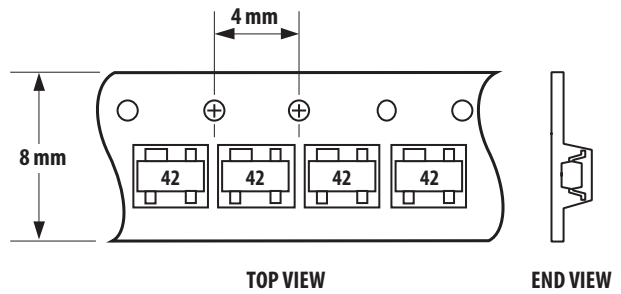
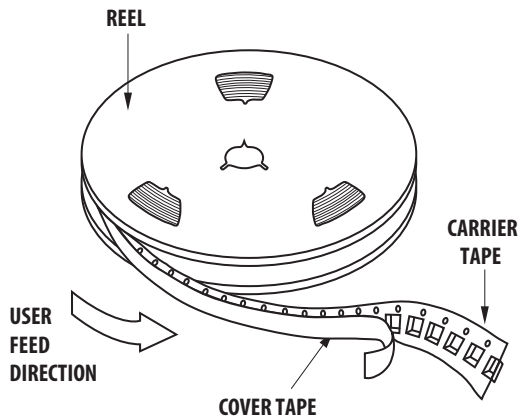

Part Number Ordering Information

| Part Number | No. of Devices | Container |
|----------------|----------------|----------------|
| MGA-52543-TR1G | 3000 | 7" Reel |
| MGA-52543-TR2G | 10000 | 13" Reel |
| MGA-52543-BLKG | 100 | antistatic bag |

Tape Dimensions For Outline 4T

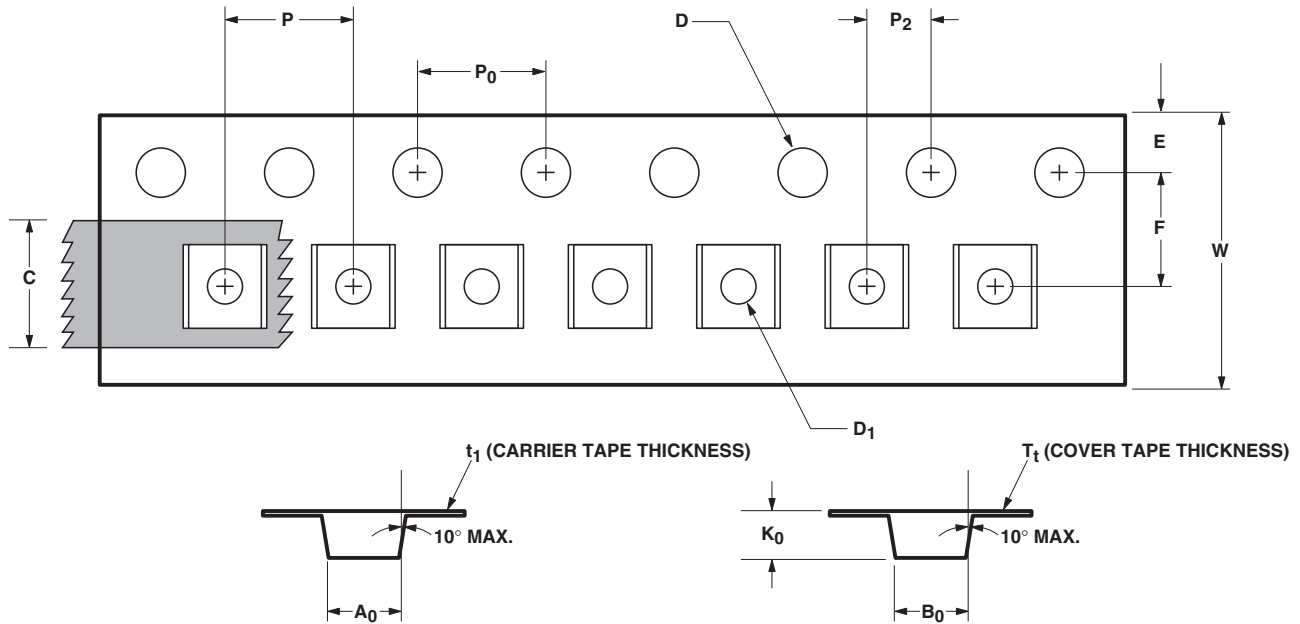

| DESCRIPTION | | SYMBOL | SIZE (mm) | SIZE (INCHES) |
|--------------|--|--------|----------------------|---------------------|
| CAVITY | LENGTH | A_0 | 2.40 ± 0.10 | 0.094 ± 0.004 |
| | WIDTH | B_0 | 2.40 ± 0.10 | 0.094 ± 0.004 |
| | DEPTH | K_0 | 1.20 ± 0.10 | 0.047 ± 0.004 |
| | PITCH | P | 4.00 ± 0.10 | 0.157 ± 0.004 |
| | BOTTOM HOLE DIAMETER | D_1 | $1.00 + 0.25$ | $0.039 + 0.010$ |
| PERFORATION | DIAMETER | D | 1.55 ± 0.10 | $0.061 + 0.002$ |
| | PITCH | P_0 | 4.00 ± 0.10 | 0.157 ± 0.004 |
| | POSITION | E | 1.75 ± 0.10 | 0.069 ± 0.004 |
| CARRIER TAPE | WIDTH | W | $8.00 + 0.30 - 0.10$ | $0.315 + 0.012$ |
| | THICKNESS | t_1 | 0.254 ± 0.02 | 0.0100 ± 0.0008 |
| COVER TAPE | WIDTH | C | 5.40 ± 0.10 | $0.205 + 0.004$ |
| | TAPE THICKNESS | T_t | 0.062 ± 0.001 | 0.0025 ± 0.0004 |
| DISTANCE | CAVITY TO PERFORATION (WIDTH DIRECTION) | F | 3.50 ± 0.05 | 0.138 ± 0.002 |
| | CAVITY TO PERFORATION (LENGTH DIRECTION) | P_2 | 2.00 ± 0.05 | 0.079 ± 0.002 |

For product information and a complete list of distributors, please go to our web site: www.avagotech.com

Avago, Avago Technologies, and the A logo are trademarks of Avago Technologies in the United States and other countries. Data subject to change. Copyright © 2005-2012 Avago Technologies. All rights reserved. Obsoletes 5989-4192EN AV02-1271EN - June 8, 2012

AVAGO
TECHNOLOGIES