



Chipsmall Limited consists of a professional team with an average of over 10 year of expertise in the distribution of electronic components. Based in Hongkong, we have already established firm and mutual-benefit business relationships with customers from,Europe,America and south Asia,supplying obsolete and hard-to-find components to meet their specific needs.

With the principle of “Quality Parts,Customers Priority,Honest Operation,and Considerate Service”,our business mainly focus on the distribution of electronic components. Line cards we deal with include Microchip,ALPS,ROHM,Xilinx,Pulse,ON,Everlight and Freescale. Main products comprise IC,Modules,Potentiometer,IC Socket,Relay,Connector.Our parts cover such applications as commercial,industrial, and automotives areas.

We are looking forward to setting up business relationship with you and hope to provide you with the best service and solution. Let us make a better world for our industry!



## Contact us

Tel: +86-755-8981 8866 Fax: +86-755-8427 6832

Email & Skype: info@chipsmall.com Web: www.chipsmall.com

Address: A1208, Overseas Decoration Building, #122 Zhenhua RD., Futian, Shenzhen, China



# MGA-633P8

## Ultra Low Noise, High Linearity Active Bias Low Noise Amplifier



### Data Sheet

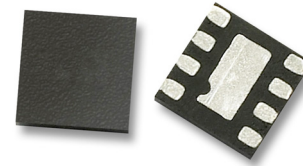

#### Description

Avago Technologies' MGA-633P8 is an economical, easy-to-use GaAs MMIC Low Noise Amplifier (LNA). The LNA has low noise and high linearity achieved through the use of Avago Technologies' proprietary 0.25um GaAs Enhancement-mode pHEMT process. It is housed in a miniature 2.0 x 2.0 x 0.75mm<sup>3</sup> 8-pin Quad-Flat-Non-Lead (QFN) package. It is designed for optimum use from 450MHz up to 2GHz. The compact footprint and low profile coupled with low noise, high gain and high linearity make the MGA-633P8 an ideal choice as a low noise amplifier for cellular infrastructure for GSM and CDMA. For optimum performance at higher frequency from 1.5GHz to 2.3GHz, the MGA-634P8 is recommended, and from 2.3GHz to 4GHz, the MGA-635P8 is recommended. Both MGA-634P8 and MGA-635P8 share the same package and pinout as MGA-633P8

#### Pin Configuration and Package Marking

2.0 x 2.0 x 0.75 mm<sup>3</sup> 8-lead QFN

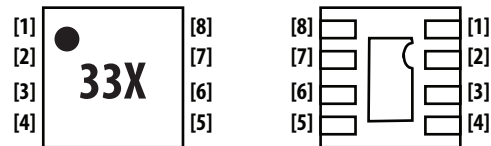

Top View

Bottom View

Pin1 – Vbias  
Pin2 – RFin  
Pin3 – Not Used  
Pin4 – Not Used

Pin5 – Not Used  
Pin6 – Not Used  
Pin7 – RFOutput / Vdd  
Pin8 – Not Used  
Centre tab - Ground

Note:  
Package marking provides orientation and identification  
"33" = Device Code  
"X" = Month Code



**Attention: Observe precautions for handling electrostatic sensitive devices.**  
ESD Machine Model = 90 V (Class A)  
ESD Human Body Model = 600 V (Class 1B)  
Refer to Avago Application Note A004R:  
Electrostatic Discharge, Damage and Control.

#### Features

- Ultra Low noise Figure
- High linearity performance
- GaAs E-pHEMT Technology [1]
- Low cost small package size: 2.0 x 2.0 x 0.75 mm<sup>3</sup>
- Excellent uniformity in product specifications
- Tape-and-Reel packaging option available

#### Specifications

900MHz; 5V, 54mA

- 18 dB Gain
- 0.37 dB Noise Figure
- 15dB Input Return Loss
- 37 dBm Output IP3
- 22 dBm Output Power at 1dB gain compression

#### Applications

- Low noise amplifier for cellular infrastructure for GSM and CDMA.
- Other ultra low noise application.

#### Simplified Schematic

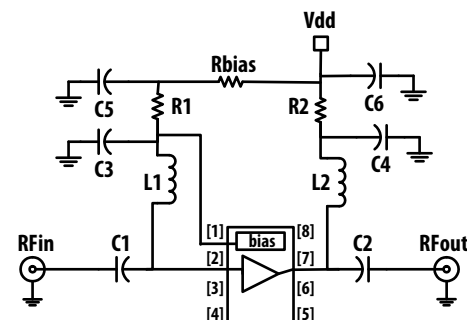

Notes:

- The schematic is shown with the assumption that similar PCB is used for all MGA-633P8, MGA-634P8 and MGA-635P8.
- Detail of the components needed for this product is shown in Table 1.
- Enhancement mode technology employs positive gate voltage, thereby eliminating the need of negative gate voltage associated with conventional depletion mode devices.
- Good RF practice requires all unused pins to be earthed.

### Absolute Maximum Rating<sup>[1]</sup> T<sub>A</sub>=25°C

Symbol	Parameter	Units	Absolute Max.
V <sub>dd</sub>	Device Voltage, RF output to ground	V	5.5
I <sub>dd</sub>	Drain Current	mA	90
P <sub>max</sub>	CW RF Input Power (V <sub>dd</sub> = 5.0 V, I <sub>dd</sub> = 54 mA)	dBm	+20
P <sub>diss</sub>	Total Power Dissipation <sup>[3]</sup>	W	0.495
T <sub>j</sub>	Junction Temperature	°C	150
T <sub>STG</sub>	Storage Temperature	°C	-65 to 150

### Thermal Resistance

Thermal Resistance <sup>[2]</sup>  
(V<sub>dd</sub> = 5.0 V, I<sub>dd</sub> = 54 mA), θ<sub>jc</sub> = 72°C/W

Notes:

1. Operation of this device in excess of any of these limits may cause permanent damage.
2. Thermal resistance measured using Infra-Red Measurement Technique.
3. Power dissipation with unit turned on. Board temperature T<sub>B</sub> is 25°C. Derate at 13.89mW/°C for T<sub>B</sub>>114°C.

### Electrical Specifications<sup>[1, 4]</sup>

RF performance at T<sub>A</sub> = 25°C, V<sub>dd</sub> = 5V, R<sub>bias</sub> = 6.8kΩ, 900MHz, measured on demo board in Figure 5 with component list in Table 1 for 900 MHz matching.

Symbol	Parameter and Test Condition	Units	Min.	Typ.	Max.
I <sub>dd</sub>	Drain Current	mA	39	54	67
Gain	Gain	dB	16.5	18	19.5
OIP3 <sup>[2]</sup>	Output Third Order Intercept Point	dBm	34	37	
NF <sup>[3]</sup>	Noise Figure	dB		0.37	0.6
OP1dB	Output Power at 1dB Gain Compression	dBm		22	
IRL	Input Return Loss, 50Ω source	dB		15	
ORL	Output Return Loss, 50Ω load	dB		21	
REV ISOL	Reverse Isolation	dB		21	

Notes:

1. Measurements at 900 MHz obtained using demo board described in Figure 1.
2. OIP3 test condition: F<sub>RF1</sub> = 900 MHz, F<sub>RF2</sub> = 901 MHz with input power of -15dBm per tone.
3. For NF data, board losses of the input have not been de-embedded.
4. Use proper bias, heatsink and derating to ensure maximum device temperature is not exceeded. See absolute maximum ratings and application note for more details.



## Product Consistency Distribution Charts<sup>[1, 2]</sup>

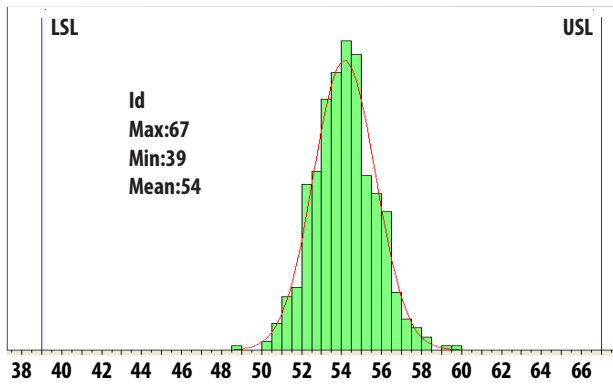

Figure 1. Id @ 900MHz, 5V, 54mA  
Mean = 54

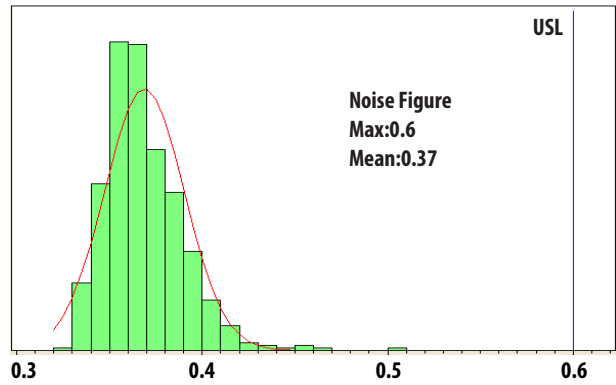

Figure 2. Noise Figure @ 900MHz, 5V, 54mA  
Mean = 0.37

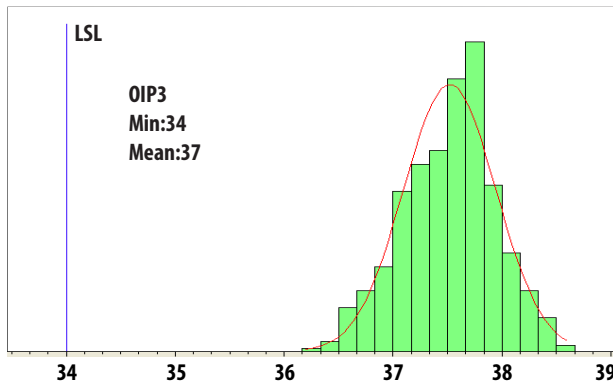

Figure 3. OIP3 @ 900MHz, 5V, 54mA  
Mean = 37

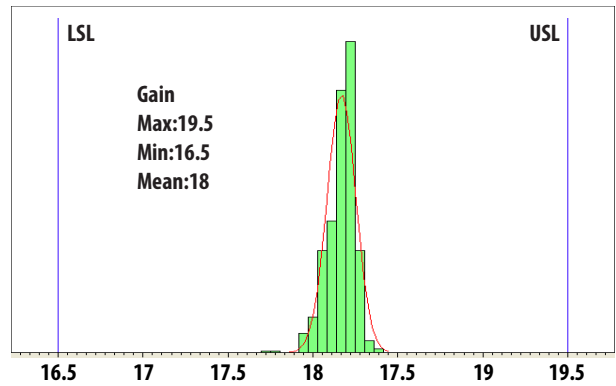

Figure 4. Gain @ 900MHz, 5V, 54mA  
Mean = 18

### Notes:

1. Distribution data samples are 500 samples taken from 3 different wafers. Future wafers allocated to this product may have nominal values anywhere between the upper and lower limits.
2. Circuit Losses have not been de-embedded from the actual measurements.

## Demo Board Layout

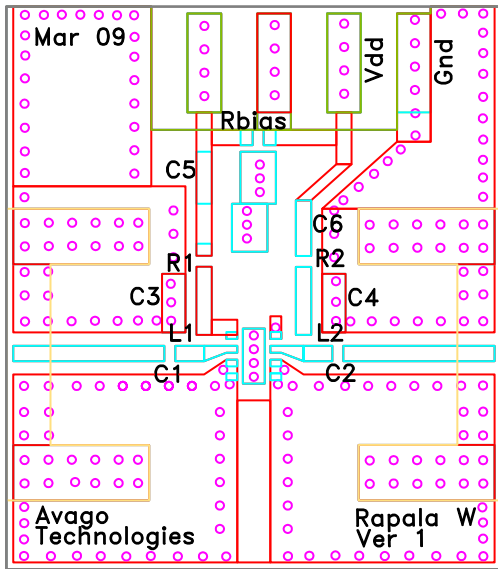

Figure 5. Demo Board Layout Diagram

- Recommended PCB material is 10 mils Rogers RO4350.
- Suggested component values may vary according to layout and PCB material.

## Demo Board Schematic

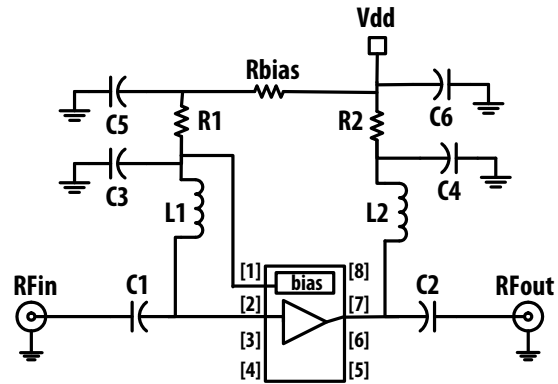

Figure 6. Demo Board Schematic Diagram

Note:

- The schematic is shown with the assumption that similar PCB is used for all MGA-633P8, MGA-634P8 and MGA-635P8.
- Detail of the components needed for this product is shown in Table 1.

Table 1. Component list for 900 MHz matching

Part	Size	Value	Detail Part Number
C1, C2	0402	100pF (Murata)	GRM1555C1H101JD01E
L1, L2	0402	33nH (Toko)	LL1005-FHL33NJ
C4	0402	33pF (Kyocera)	CM05CH330J50AH
C3, C6	0402	4.7uF (Murata)	GRM155R60E475ME760
R1	0402	0 Ohm (Kamaya)	RMC1/16S-JPTH
R2	0402	10 Ohm (Koa)	RM73B1ETTP100J

Note:

C1, C2 are DC Blocking capacitors; L1 input match for NF; L2 output match for OIP3; C3, C4, C6 are bypass capacitors; R2 is stabilizing resistor; Rbias is the biasing resistor; R1, C5 are not use for this product

## MGA-633P8 Typical Performance

RF performance at  $T_A = 25^\circ\text{C}$ ,  $V_{dd} = 5\text{V}$ ,  $I_d = 54\text{mA}$ , measured using 50ohm input and output board, unless otherwise stated. OIP3 test condition:  $F_{RF1} = 900\text{MHz}$ ,  $F_{RF2} = 901\text{MHz}$  with input power of  $-10\text{dBm}$  per tone.

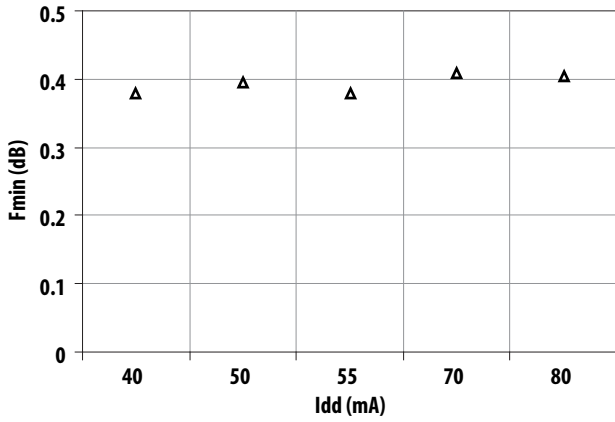

Figure 7. Fmin vs Idd at 5V at 700MHz

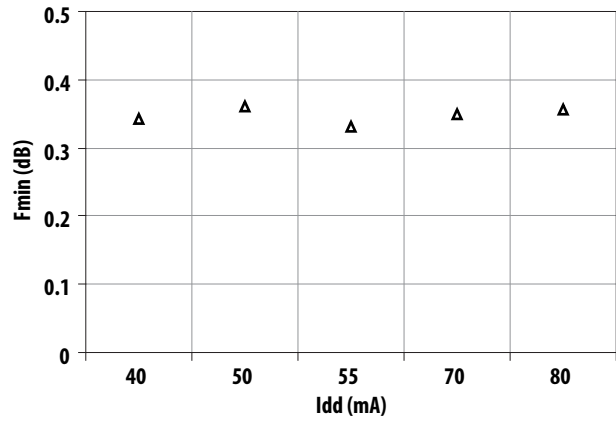

Figure 8. Fmin vs Idd at 5V at 900MHz

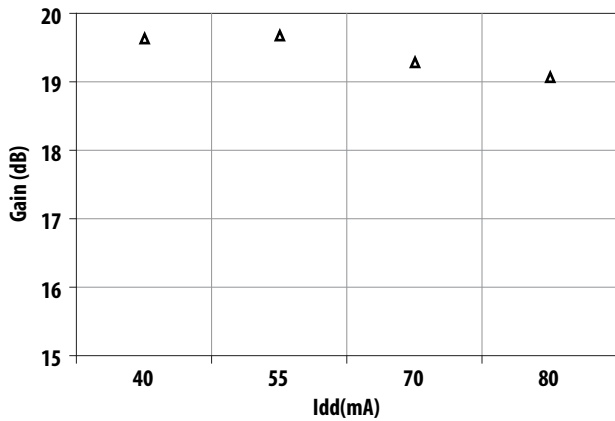

Figure 10. Gain vs Idd at 5V Tuned for Optimum OIP3 and Fmin at 700MHz

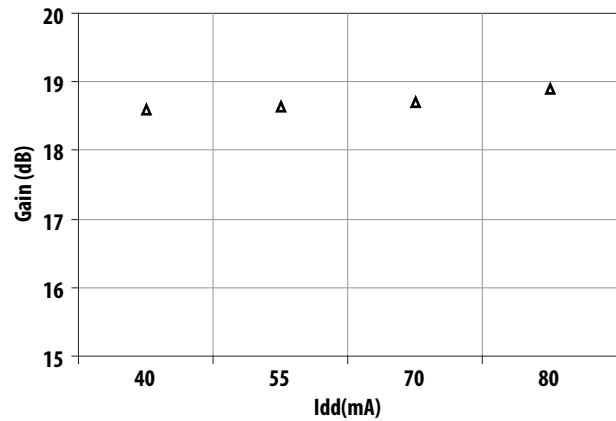

Figure 11. Gain vs Idd at 5V Tuned for Optimum OIP3 and Fmin at 900MHz

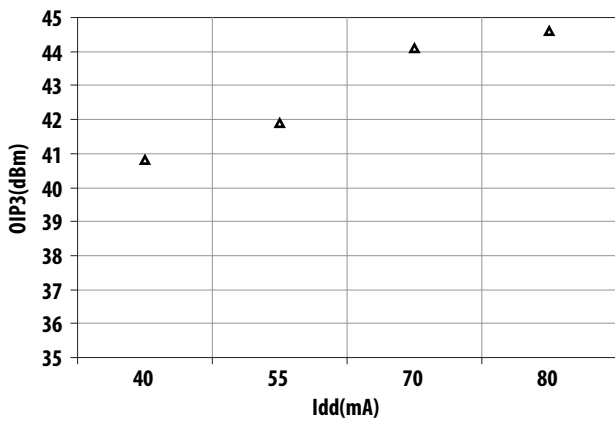

Figure 12. OIP3 vs Idd at 5V Tuned for Optimum OIP3 and Fmin at 700MHz

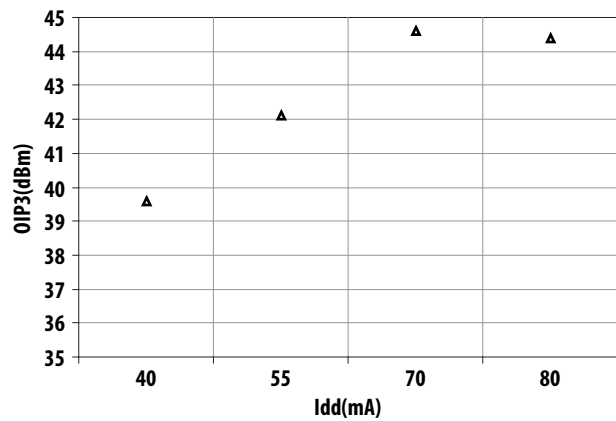

Figure 13. OIP3 vs Idd at 5V Tuned for Optimum OIP3 and Fmin at 900MHz

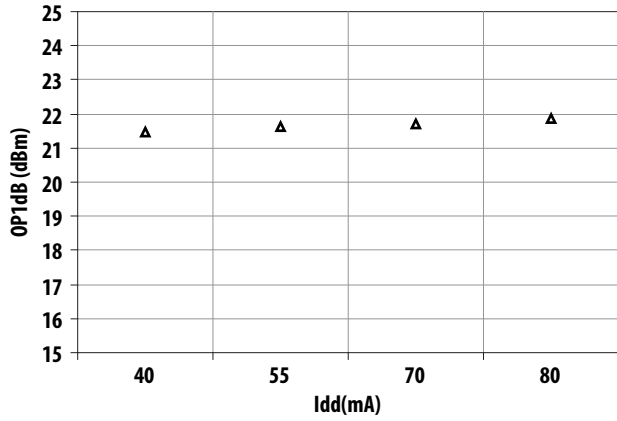

Figure 14. OP1dB vs Idd at 5V Tuned for Optimum OIP3 and Fmin at 700MHz

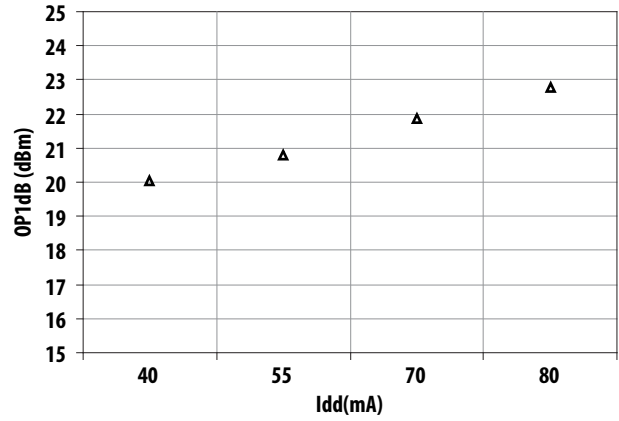

Figure 15. OP1dB vs Idd at 5V Tuned for Optimum OIP3 and Fmin at 900MHz

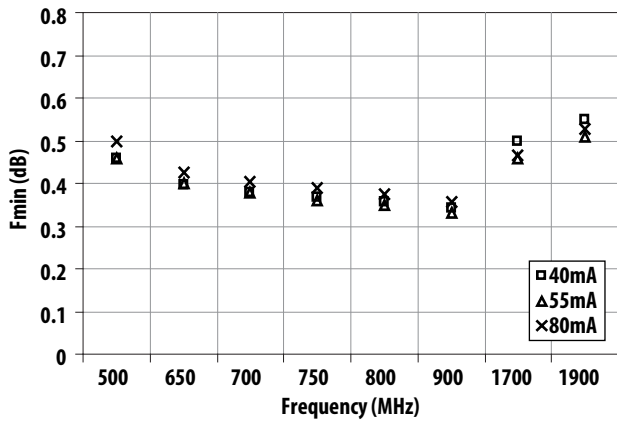

Figure 16. Fmin vs Frequency and Idd at 5V

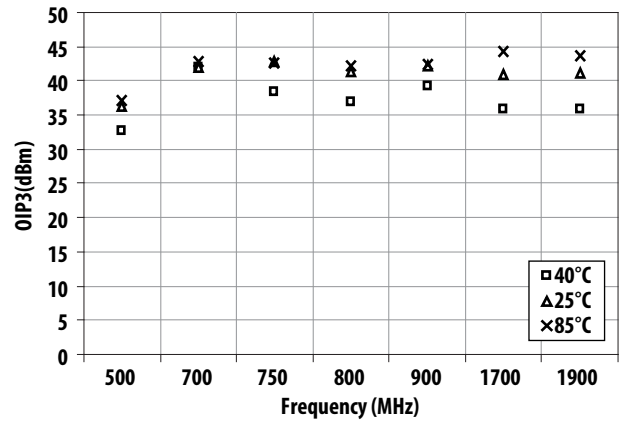

Figure 17. OIP3 vs Frequency and Temperature for Optimum OIP3 and Fmin at 5V 54mA

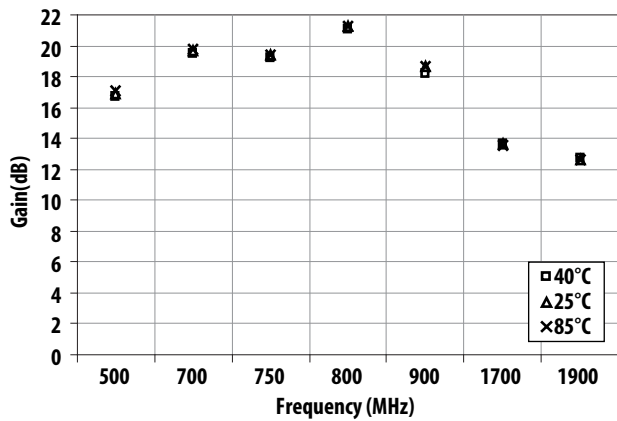

Figure 18. Gain vs Frequency and Temperature for Optimum OIP3 and Fmin at 5V 54mA

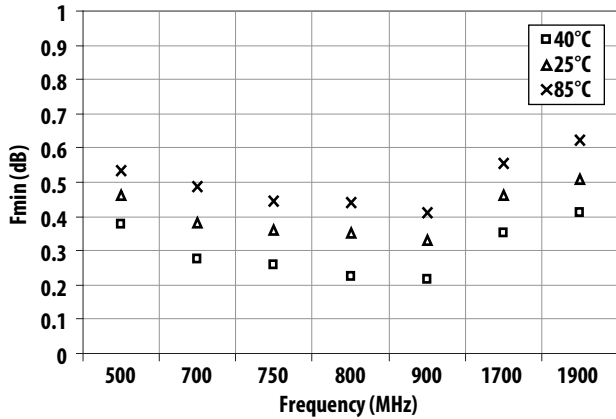

Figure 19. Fmin vs Frequency and Temperature for Optimum OIP3 and Fmin at 5V 54mA

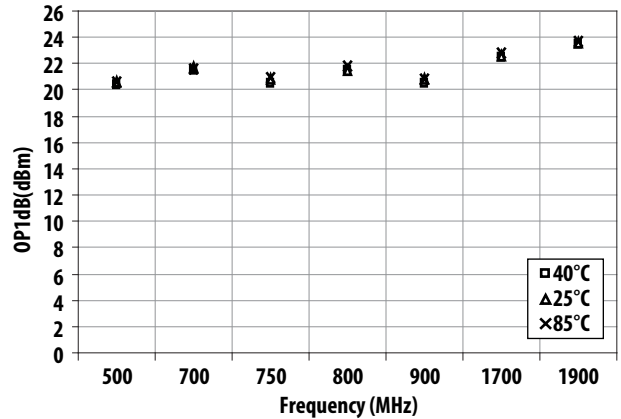

Figure 20. OP1dB vs Frequency and Temperature for Optimum OIP3 and Fmin at 5V 54mA

Below is the table showing the MGA-633P8 Reflection Coefficient Parameters tuned for Maximum OIP3, Vdd = 5V, Idd = 54mA.

Frequency (GHz)	Gamma Load position		OIP3 (dBm)	OP1dB (dBm)
	Magnitude	Angle		
0.50	0.53	122	36.2	22.96
0.70	0.49	115	41.9	21.67
0.75	0.539	113	42.7	20.87
0.80	0.659	123	41.2	21.52
0.90	0.635	145	42.1	20.79
1.70	0.342	-120	41	22.63
1.90	0.333	-74	41.2	23.63

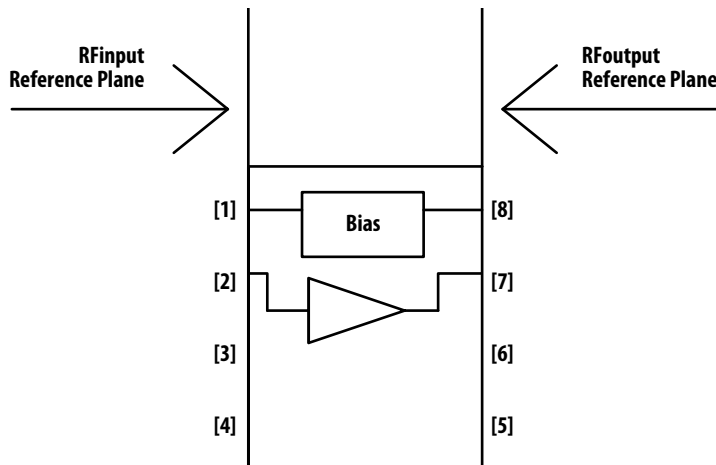

Figure 21.

Notes:

1. The Maximum OIP3 values are calculated based on Load pull measurements on approximately 100 different impedances using Maury's Load pull test system.
2. Measurements are conducted on 0.010 inch thick ROGER 4350. The input reference plane is at the end of the RFin pin and the output reference plane is at the end of the RFout pin as shown in Figure 21.
3. Gamma Load for maximum OIP3 with biasing of 3V 54mA, 3.5V 54mA, 4V 54mA, 4.5V 54mA, 5V 40mA, 5V 54mA and 5V 70mA from 800 MHz to 1.9GHz are available upon request.



## MGA-633P8 Typical Performance in Demoboard

RF performance at  $T_A = 25^\circ\text{C}$ ,  $V_{dd} = 5\text{V}$ ,  $R_{bias} = 6.8\text{k}\Omega$ , measured on demo board in Figure.5 with component list in Table1 for 900 MHz matching, unless otherwise stated.

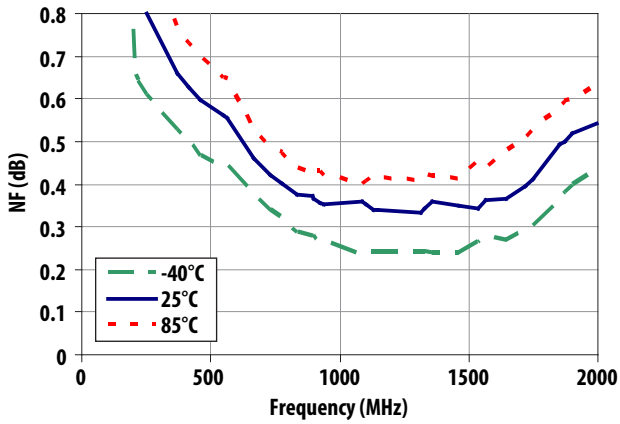

Figure 22. NF vs Frequency vs Temperature

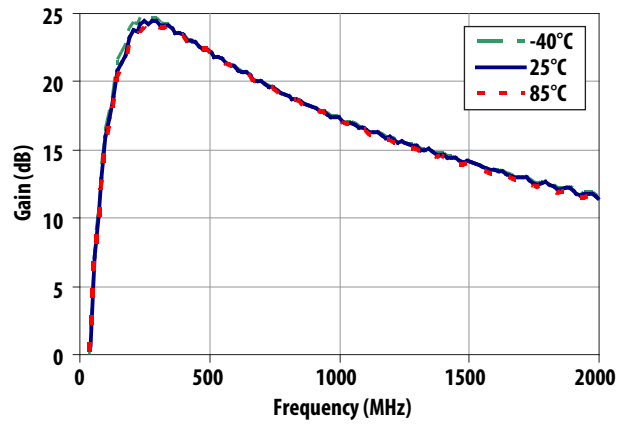

Figure 23. Gain vs Frequency vs Temperature

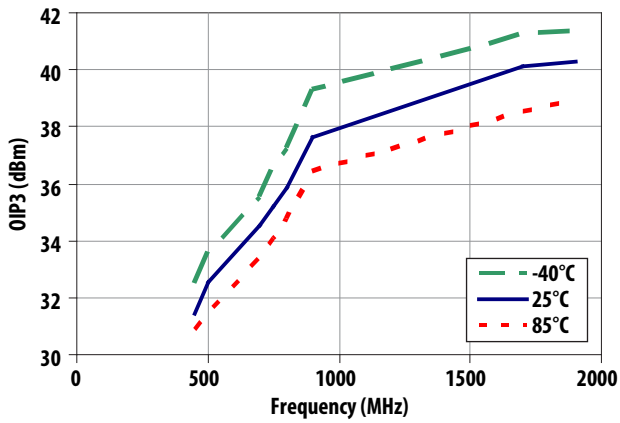

Figure 24. OIP3 vs Frequency vs Temperature

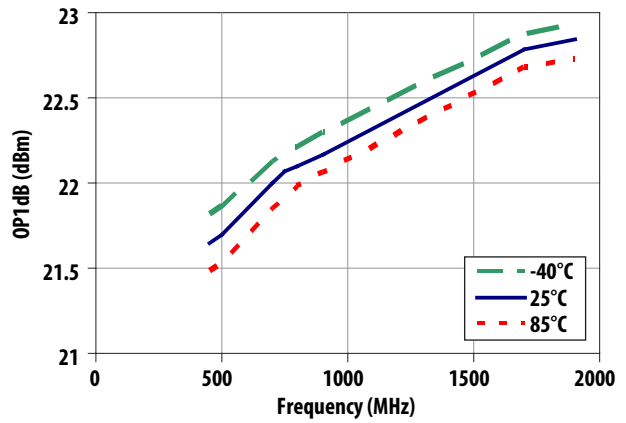

Figure 25. OP1dB vs Frequency vs Temperature

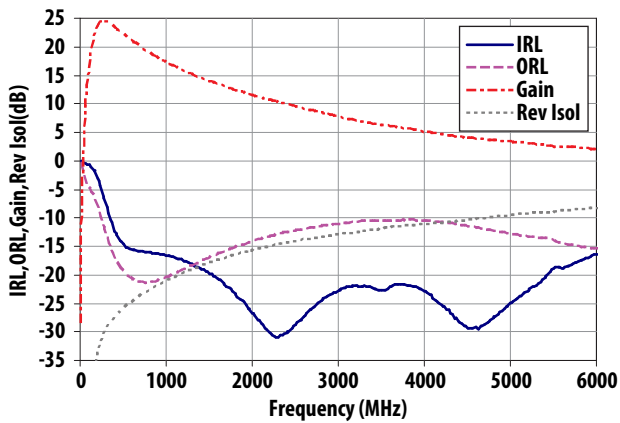

Figure 26. Input Return Loss, Output Return Loss, Gain, Reverse Isolation vs Frequency

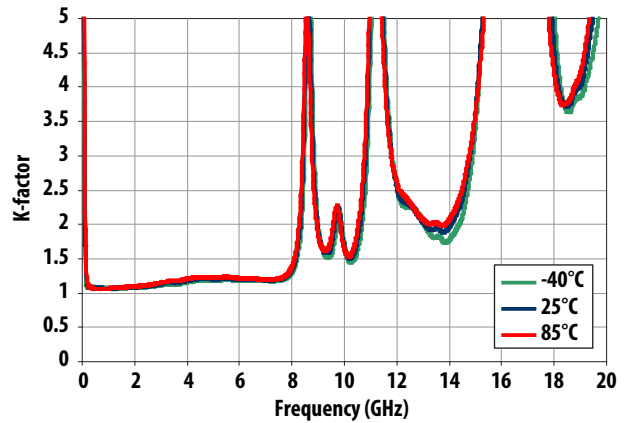

Figure 27. K-factor vs Frequency vs Temperature

## MGA-633P8 Typical Performance in Demoboard

RF performance at  $T_A = 25^\circ\text{C}$ ,  $V_{dd} = 5\text{V}$ ,  $R_{bias} = 6.8\text{k}\Omega$ , measured on demo board in Figure.5 with component list in Table1 for 900 MHz matching, unless otherwise stated.

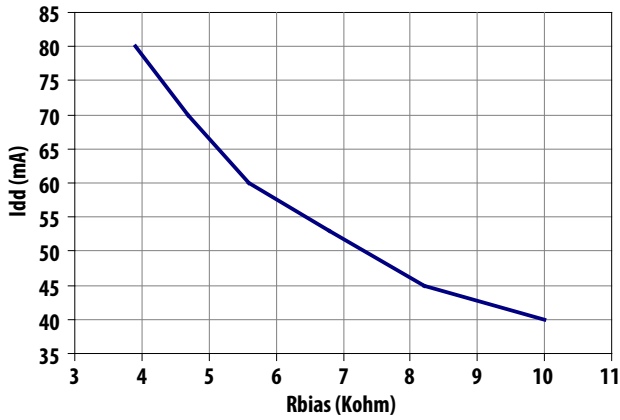

Figure 28. Idd vs Rbias

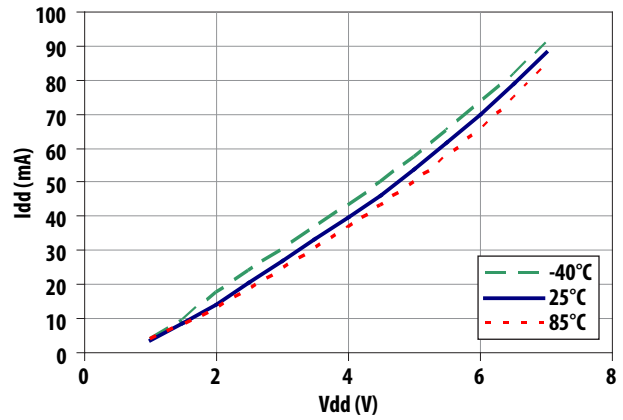

Figure 29. Idd vs Vdd vs Temperature

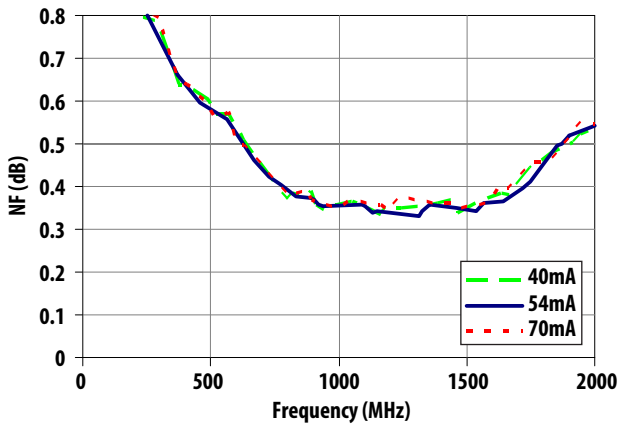

Figure 30. NF vs Frequency vs Idd

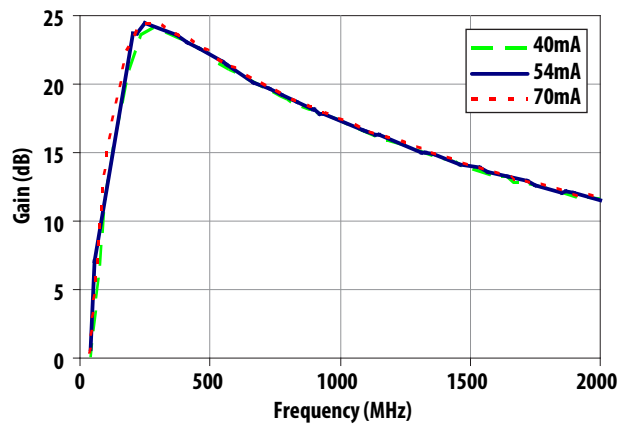

Figure 31. Ga vs Frequency vs Idd

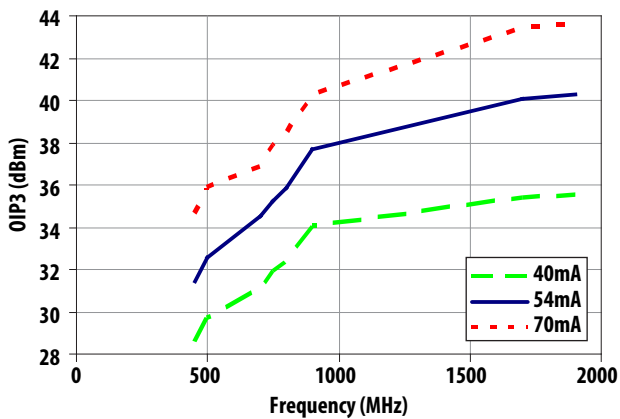

Figure 32. OIP3 vs Frequency vs Idd

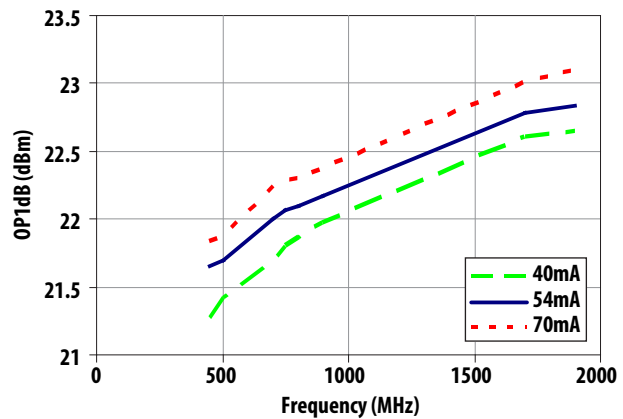

Figure 33. OP1dB vs Frequency vs Idd

**MGA-633P8 Typical Scattering Parameters, Vdd = 5V, Idd = 54mA**

Freq GHz	S <sub>11</sub>			S <sub>21</sub>		S <sub>12</sub>		S <sub>22</sub>	
	Mag.	Ang.	dB	Mag.	Ang.	Mag.	Ang.	Mag.	Ang.
0.1	0.73	-45.42	28.96	28.06	145.48	0.02	62.09	0.27	-43.62
0.5	0.25	-95.49	22.03	12.64	108.20	0.05	59.34	0.10	-4.56
0.9	0.16	-119.26	18.08	8.02	89.72	0.08	60.53	0.14	-16.96
1.0	0.15	-124.97	17.27	7.30	86.35	0.09	60.46	0.15	-18.82
1.5	0.10	-142.55	14.10	5.07	70.97	0.12	56.12	0.19	-39.65
1.9	0.07	-158.30	12.17	4.06	60.60	0.15	51.25	0.19	-56.21
2.0	0.07	-162.64	11.74	3.86	58.17	0.16	49.92	0.19	-60.31
2.5	0.05	177.70	9.88	3.12	46.59	0.20	43.20	0.21	-79.41
3.0	0.03	162.14	8.36	2.62	35.95	0.23	36.08	0.23	-95.09
4.0	0.01	-41.60	6.00	2.00	16.45	0.30	22.04	0.25	-118.55
5.0	0.03	-64.06	4.27	1.64	-1.63	0.36	7.61	0.25	-144.60
6.0	0.04	-129.24	2.96	1.41	-18.89	0.42	-7.19	0.24	-170.64
7.0	0.07	-152.03	1.85	1.24	-35.43	0.47	-22.36	0.26	165.84
8.0	0.12	-154.39	0.87	1.11	-50.92	0.52	-37.15	0.29	150.25
9.0	0.18	-161.44	0.05	1.01	-65.12	0.56	-51.58	0.33	138.58
10.0	0.21	-177.23	-0.57	0.94	-78.96	0.60	-66.28	0.35	124.74
11.0	0.21	156.03	-1.03	0.89	-93.28	0.63	-81.96	0.33	104.27
12.0	0.22	124.49	-1.53	0.84	-108.35	0.66	-98.72	0.33	78.81
13.0	0.26	104.45	-2.13	0.78	-122.84	0.66	-115.13	0.38	62.57
14.0	0.33	95.24	-2.66	0.74	-135.50	0.66	-129.75	0.42	60.19
15.0	0.39	84.99	-2.96	0.71	-146.69	0.66	-143.01	0.43	60.20
16.0	0.42	67.14	-3.10	0.70	-159.52	0.67	-157.83	0.40	50.25
17.0	0.43	44.98	-3.53	0.67	-175.16	0.66	-175.42	0.40	27.20
18.0	0.49	28.99	-4.50	0.60	169.61	0.60	167.43	0.48	10.68
19.0	0.57	17.18	-5.59	0.53	156.86	0.53	152.94	0.56	7.82
20.0	0.62	5.97	-6.14	0.49	145.85	0.50	140.18	0.60	6.77

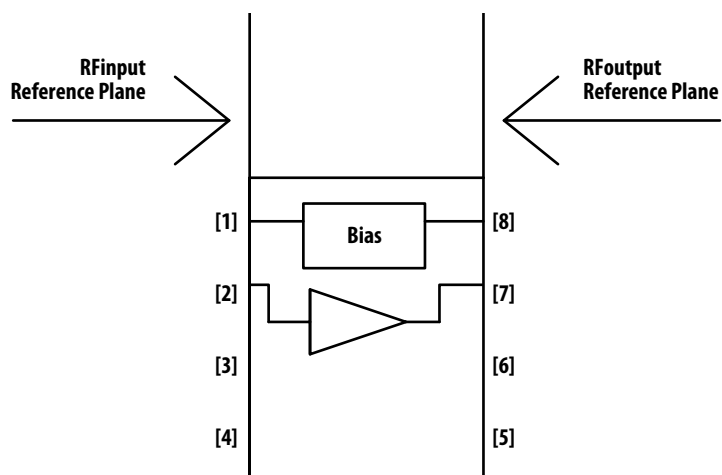

Figure 34

### Typical Noise Parameters, Vdd = 5V, Idd = 54mA

Freq GHz	Fmin dB	$\Gamma_{opt}$ Mag.	$\Gamma_{opt}$ Ang.	$R_{n/50}$
0.5	0.46	0.169	-37	0.051
0.7	0.38	0.15	-17	0.0586
0.75	0.36	0.144	-15	0.0532
0.8	0.35	0.136	-13	0.0478
0.9	0.33	0.129	-7	0.0446
1.7	0.46	0.048	80.5	0.0644
1.9	0.51	0.028	98.7	0.0498

#### Notes:

1. The Fmin values are based on noise figure measurements at 100 different impedances using Focus source pull test system. From these measurements a true Fmin is calculated.
2. Scattering and noise parameters are measured on coplanar waveguide made on 0.010 inch thick ROGER 4350. The input reference plane is at the end of the RFinpin and the output reference plane is at the end of the RFoutput pin as shown in Figure 30.
3. S2P file with scattering and noise parameters for biasing 3V 54mA, 3.5V 54mA, 4V 54mA, 4.5V 54mA, 5V 40mA, 5V 54mA and 5V 70mA are available upon request.

### Part Number Ordering Information

Part Number	No. of Devices	Container
MGA-633P8-BLKG	100	Antistatic Bag
MGA-633P8-TR1G	3000	7 inch Reel

### SLP2X2 Package

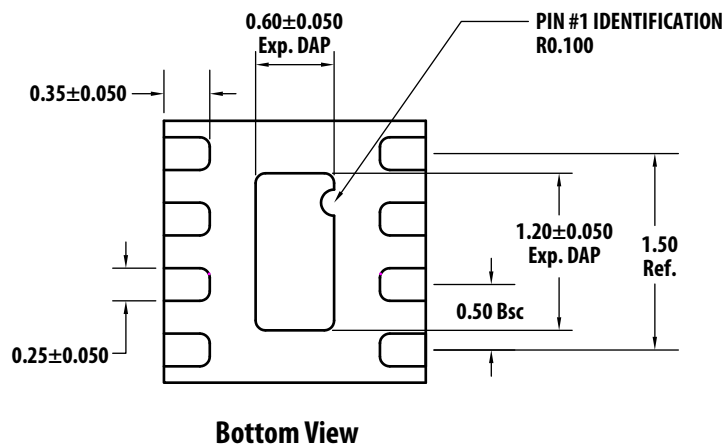
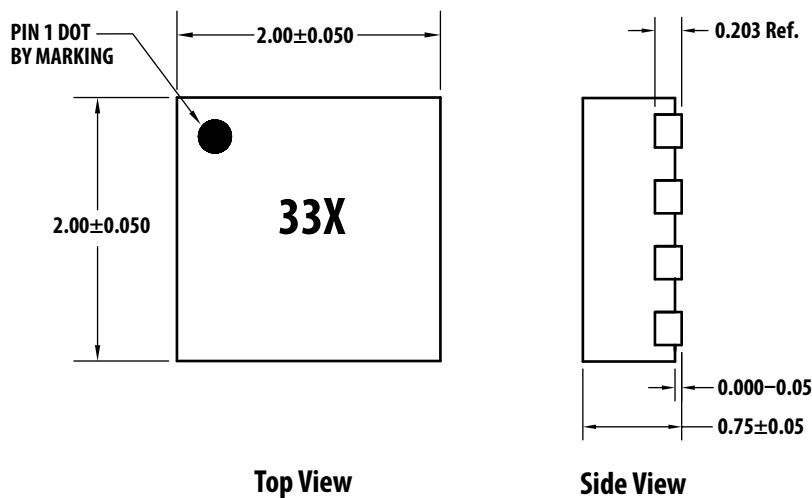

#### Notes:

1. All dimensions are in millimeters.
2. Dimensions are inclusive of plating.
3. Dimensions are exclusive of mold flash and metal burr.



## Device Orientation

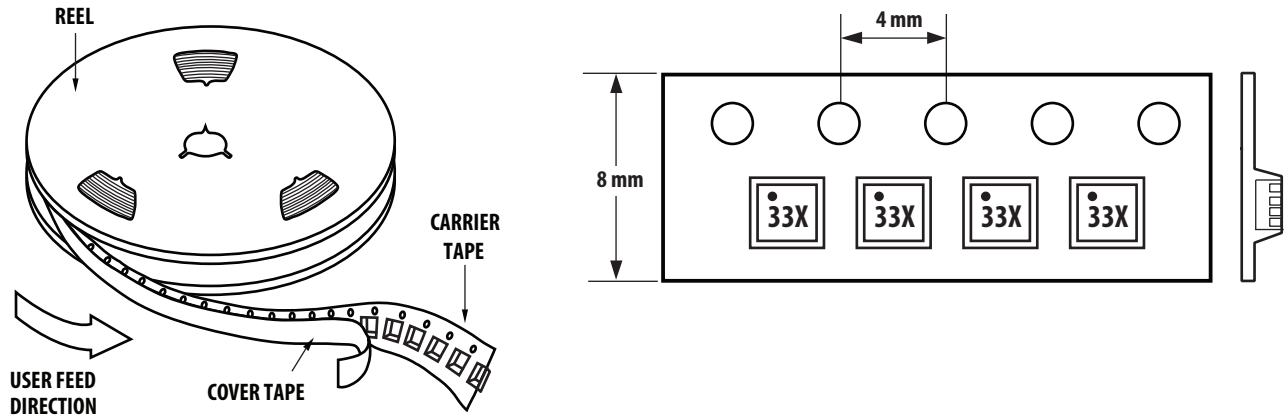

## Tape Dimensions

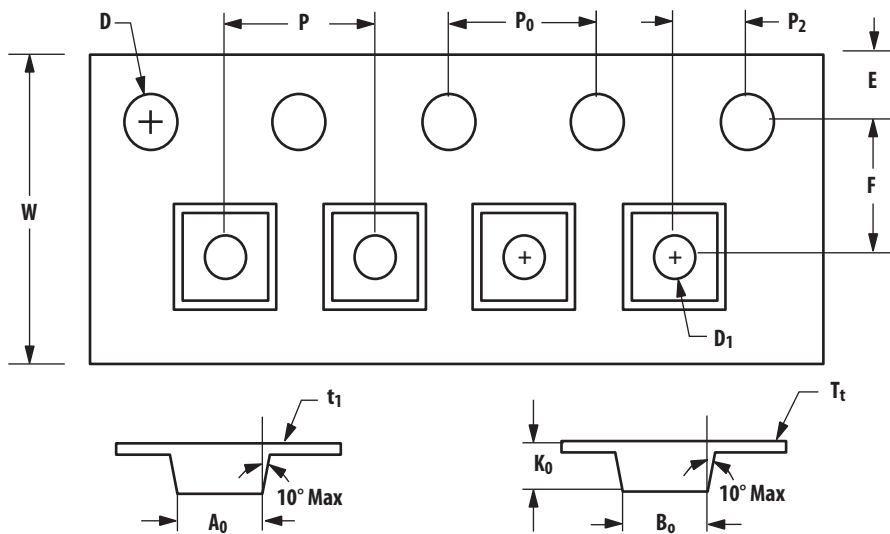

DESCRIPTION		SYMBOL	SIZE (mm)	SIZE (inches)
CAVITY	LENGTH	$A_0$	$2.30 \pm 0.05$	$0.091 \pm 0.004$
	WIDTH	$B_0$	$2.30 \pm 0.05$	$0.091 \pm 0.004$
	DEPTH	$K_0$	$1.00 \pm 0.05$	$0.039 \pm 0.002$
	PITCH	$P_1$	$4.00 \pm 0.10$	$0.157 \pm 0.004$
	BOTTOM HOLE DIAMETER	$D$	$1.00 + 0.25$	$0.039 + 0.002$
PERFORATION	DIAMETER	$D$	$1.50 \pm 0.10$	$0.060 \pm 0.004$
	PITCH	$P_0$	$4.00 \pm 0.10$	$0.157 \pm 0.004$
	POSITION	$E$	$1.75 \pm 0.10$	$0.069 \pm 0.004$
CARRIER TAPE	WIDTH	$W$	$8.00 + 0.30$ $8.00 \pm 0.10$	$0.315 \pm 0.012$ $0.315 \pm 0.004$
	THICKNESS	$t_1$	$0.254 \pm 0.02$	$0.010 \pm 0.0008$
COVER TAPE	WIDTH	$C$	$5.4 \pm 0.10$	$0.205 \pm 0.004$
	TAPE THICKNESS	$T_t$	$0.062 \pm 0.001$	$0.0025 \pm 0.004$
DISTANCE	CAVITY TO PERFORATION (WIDTH DIRECTION)	$F$	$3.50 \pm 0.05$	$0.138 \pm 0.002$
	CAVITY TO PERFORATION (LENGTH DIRECTION)	$P_2$	$2.00 \pm 0.05$	$0.079 \pm 0.002$



# Reel Dimensions – 7 inch

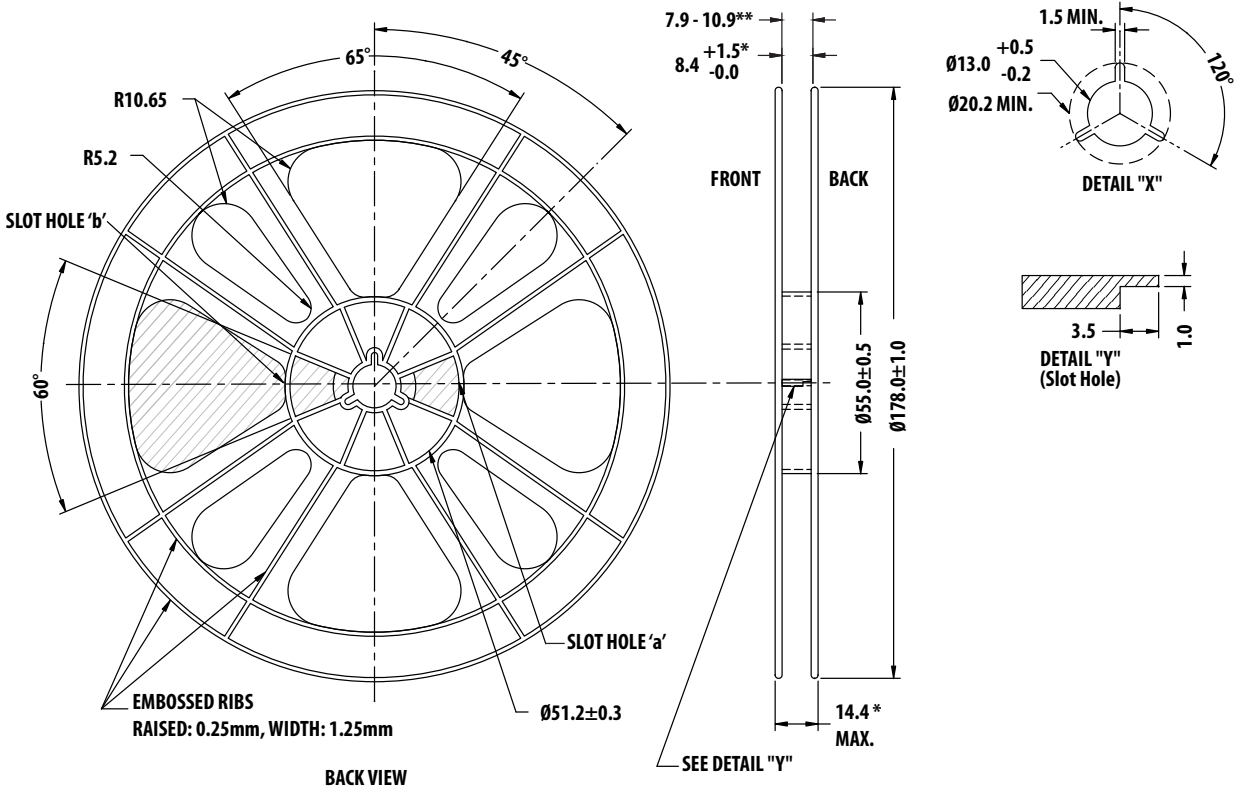
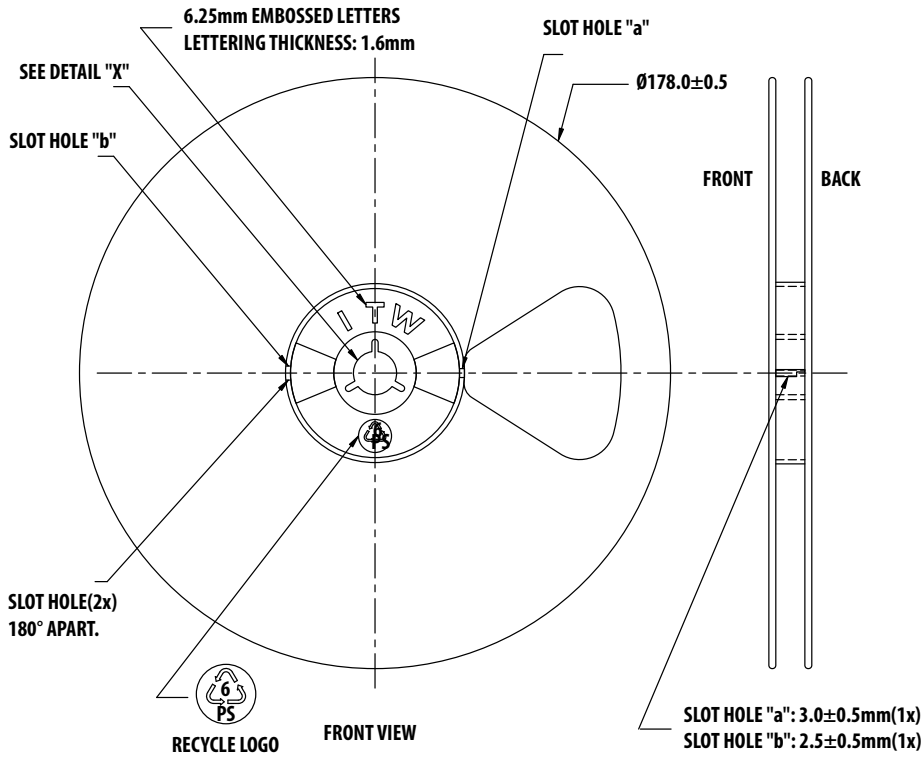

For product information and a complete list of distributors, please go to our web site: [www.avagotech.com](http://www.avagotech.com)

Avago, Avago Technologies, and the A logo are trademarks of Avago Technologies in the United States and other countries. Data subject to change. Copyright © 2005-2014 Avago Technologies. All rights reserved. AV02-2329EN - July 8, 2014

