



Chipsmall Limited consists of a professional team with an average of over 10 year of expertise in the distribution of electronic components. Based in Hongkong, we have already established firm and mutual-benefit business relationships with customers from,Europe,America and south Asia,supplying obsolete and hard-to-find components to meet their specific needs.

With the principle of “Quality Parts,Customers Priority,Honest Operation,and Considerate Service”,our business mainly focus on the distribution of electronic components. Line cards we deal with include Microchip,ALPS,ROHM,Xilinx,Pulse,ON,Everlight and Freescale. Main products comprise IC,Modules,Potentiometer,IC Socket,Relay,Connector.Our parts cover such applications as commercial,industrial, and automotives areas.

We are looking forward to setting up business relationship with you and hope to provide you with the best service and solution. Let us make a better world for our industry!



Contact us

Tel: +86-755-8981 8866 Fax: +86-755-8427 6832

Email & Skype: info@chipsmall.com Web: www.chipsmall.com

Address: A1208, Overseas Decoration Building, #122 Zhenhua RD., Futian, Shenzhen, China





MIC22705YML EV

Evaluation Board

1MHz, 7A Integrated Switch High-Efficiency Synchronous Buck Regulator

General Description

The Micrel MIC22705 is a high-efficiency, 7A, integrated switch, synchronous buck (step-down) regulator. The MIC22705 achieves more than 95% efficiency and switches at 1MHz. The ultra-high speed control loop keeps the output voltage within regulation even under the extreme transient load swings commonly found in FPGAs and low-voltage ASICs. The output voltage is pre-bias safe and is adjustable down to 0.7V.

The MIC22705 offers a full range of sequencing and tracking options. The Enable/Delay (EN/DLY) and Power Good (PG) inputs allow versatile turn-on and turn-off sequencing across multiple devices. The Ramp Control™ (RC) input allows start-up voltage tracking, either directly or ratio-metrically.

The MIC22705 is available in a 24-pin 4mm x 4mm MLF® with a junction operating range from -40°C to +125°C.

Data sheets and support documentation are found on the Micrel web site: www.micrel.com.

Requirements

The MIC22705YML EV requires a power supply of 2.9V to 5.5V, and a test load. Ensure that the power supply can provide the wattage required for the chosen test load. The load can be active (electronic load) or passive (resistor). Additionally, monitor the Power Good output (PG) with a multimeter or an oscilloscope if desired.

Precautions

There is no reverse input protection on this board. When connecting supplies and signals ensure that correct polarities are observed.

Getting Started

1. V_{IN} Supplies

Connect the V_{IN} supply (2.9V to 5.5V) across the PVIN and PGND terminals. Monitor V_{IN} at the PVIN and PGND terminals with a voltmeter.

2. Enable/SHDN Inputs

The enable input EN is internally pulled up with a 1 μ A current source. When external on/off control is desired, install Q1 and R5, and connect a logic level control signal to the SHDN input. When SHDN is high, the output is off, and when SHDN is low, the output is on.

3. Monitor Outputs

Monitor the output V_{OUT} with a scope or DVM connected across the VOUT and PGND terminals.

4. Output Load

Connect a load across the VOUT and PGND terminals. Use an active or passive load.

5. Turn On the Power

Turn on the power supply and verify that $V_{OUT} = 1.8V$.

Ordering Information

Part Number	Description
MIC22705YML EV	Evaluation Board for the MIC22705YML

EV Board Features

See the MIC22705YML datasheet for detailed explanations of these functions.

Enable/Delay (EN/DLY)

Enable/Delay allows delayed turn on of the MIC22705. Install a capacitor in location C6 to increase the start-up delay of the MIC22705.

Shutdown Input (SHDN)

SHDN allows enable/disable of the MIC22705 with an external logic signal. To activate the shutdown feature, install components into the locations labeled Q1 and R5 (component recommendations are listed in the Bill of Materials later in this document). With the components installed, force SHDN high to disable the MIC22705, and low to allow the MIC22705 to operate normally.

Delay (DELAY)

DELAY allows a delayed Power Good output (PG) indication. Install a capacitor in location C8 to increase the Power Good delay timing of the MIC22705.

Ramp Control (RC)

Ramp control allows slowing the slew rate of the MIC22705 output. Increase the value of capacitor C7 to reduce the slew rate.

Power Good Output (PG)

Open drain output PG pulls low when the output voltage of the MIC22705 is out of specification. PG is pulled up to V_{IN} by a 47.5k Ω resistor.

Switch Voltage (V_{SW})

Test point V_{SW} is provided to monitor the internal switching node. V_{SW} is isolated from the switch node by 49.9 Ω resistor R6.

Typical Characteristics

V_{IN} Turn-On

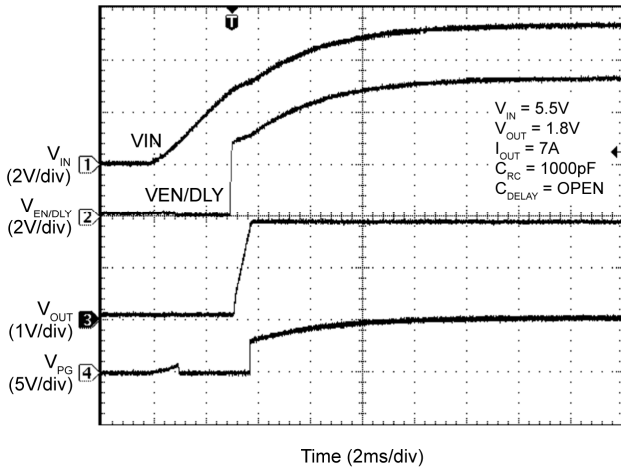

V_{IN} Turn-Off

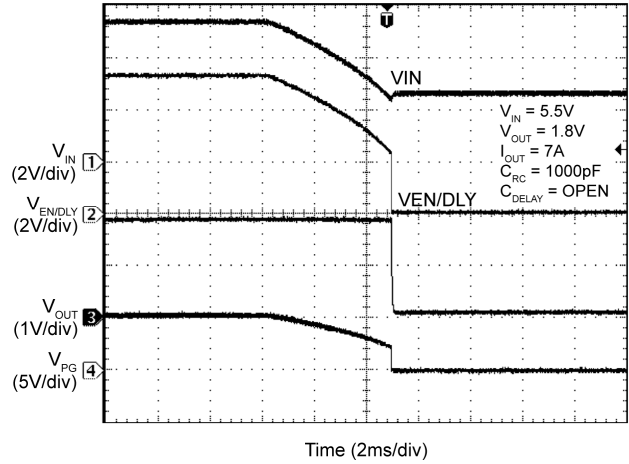

Line Transient Response

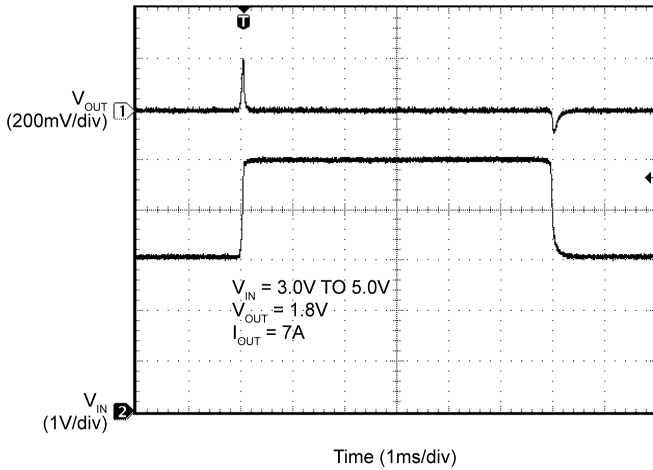

Load Transient Response

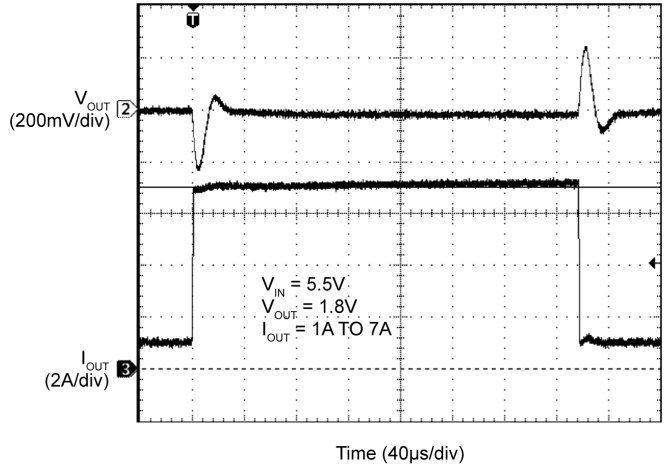

Efficiency (V_{IN} = 3.3V) vs. Output Current

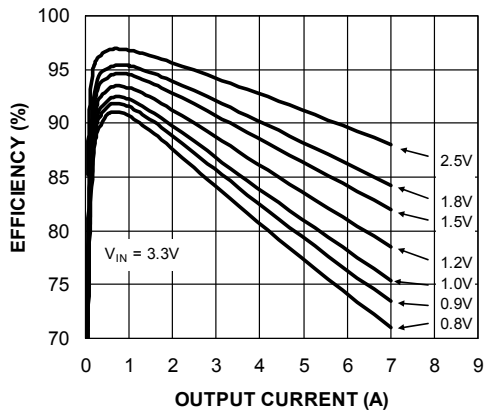

IC Power Dissipation vs. Output Current (V_{IN} = 3.3V)

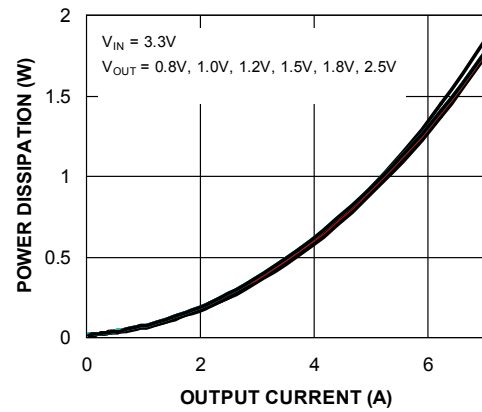

Evaluation Board Schematic

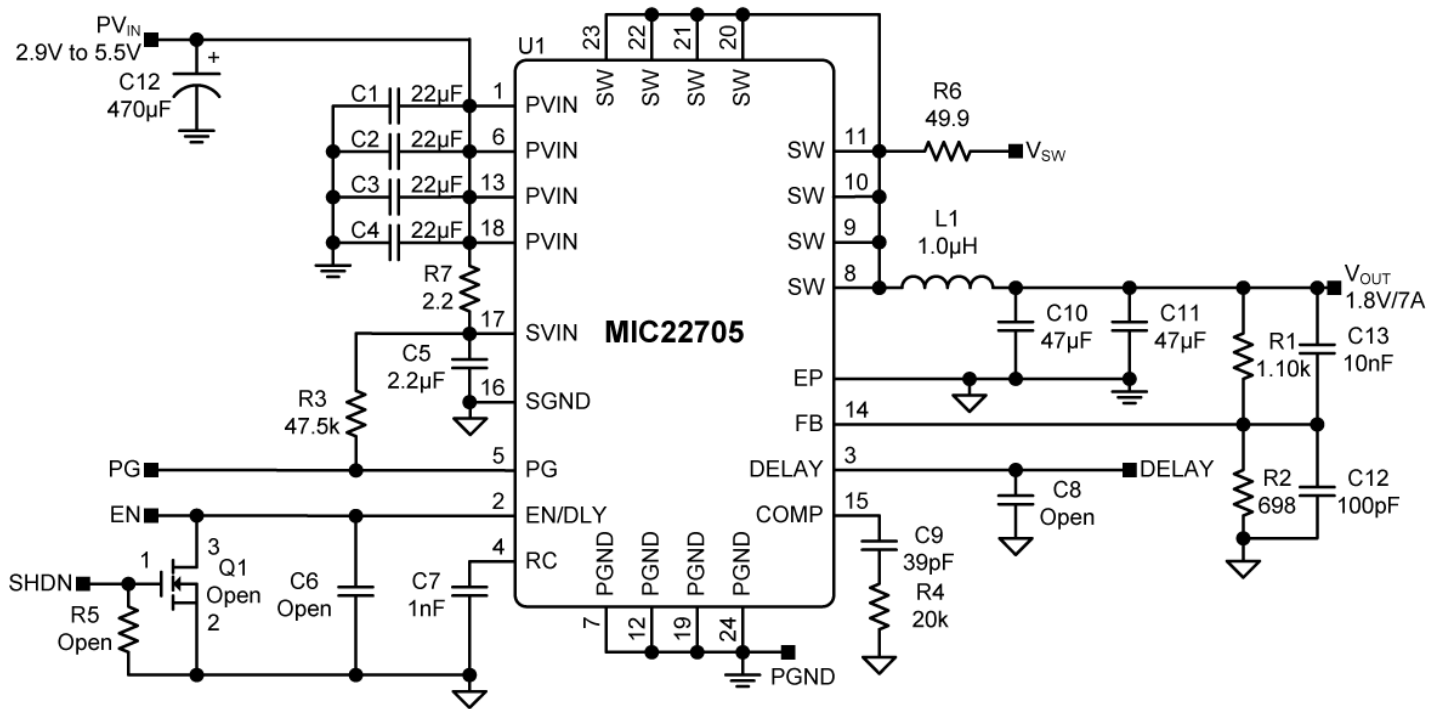

Bill of Materials

Item	Part Number	Manufacturer	Description	Qty.
C1, C2, C3, C4	C2012X5R0J226M	TDK ⁽¹⁾	22 μ F/6.3V, 0805, Ceramic Capacitor	5
	08056D226MAT	AVX ⁽²⁾		
	GRM21BR60J226ME39L	Murata ⁽³⁾		
C5	06036D225TAAT2A	AVX ⁽²⁾	2.2 μ F/6.3V, Ceramic Capacitor, X5R, Size 0805	1
	GRM188R7160J225M	Murata ⁽³⁾	2.2 μ F/6.3V, Ceramic Capacitor, X7R, Size 0805	
	C1608X5R0J225M	TDK ⁽¹⁾		
C13	GRM188R71H103KA01D	Murata ⁽³⁾	10nF, 0603, Ceramic Capacitor	1
C7	Open(VJ0603Y102KXQCW1BC)	Vishay ⁽⁴⁾	1nF, 0603, Ceramic Capacitor	1
	Open(GRM188R71H102KA01D)	Murata ⁽³⁾	1nF/50V, X7R, 0603, Ceramic Capacitor	
	Open(C1608COG1H102J)	TDK ⁽¹⁾	1nF/50V, COG, 0603, Ceramic Capacitor	
C6, C8	Open			
C9	GRM1555C1H390JZ01D	Murata ⁽³⁾	39pF/50V, COG, 0402, Ceramic Capacitor	1
	VJ0402A390KXQCW1BC	BC Components ⁽⁵⁾	39pF /10V, 0402, Ceramic Capacitor	
C10, C11	C3216X5R0J476M	TDK ⁽¹⁾	47 μ F/6.3V, X5R, 1206, Ceramic Capacitor	2
	GRM31CR60J476ME19	Murata ⁽³⁾	47 μ F/6.3V, X5R, 1206, Ceramic Capacitor	
	GRM31CC80G476ME19L	Murata ⁽³⁾	47 μ F/4V, X6S, 1206, Ceramic Capacitor	
C12	VJ0402A101KXQCW1BC	Vishay ⁽⁴⁾	100pF, 0603, Ceramic Capacitor	1
	GRM1555C1H101JZ01D	Murata ⁽³⁾	100pF/50V, COG, 0402, Ceramic Capacitor	
L1	SPM6530T-1R0M120	TDK ⁽¹⁾	1 μ H, 12A, size 7x6.5x3mm	1
	HCP0704-1R0-R	Coiltronics ⁽⁶⁾	1 μ H, 12A, size 6.8x6.8x4.2mm	
C _{IN}	BA1851A3477M	Epcos ⁽⁷⁾	470 μ F/10V, Elect., 8x11.5	1
R1	CRCW06031101FKEYE3	Vishay ⁽⁴⁾	Resistor, 1.10k, 0603, 1%	1
R2	CRCW04026980FKEYE3	Vishay ⁽⁴⁾	Resistor, 698 Ω , 0603, 1%	1
R3	CRCW06034752FKEYE3	Vishay ⁽⁴⁾	Resistor, 47.5k, 0603, 1%	1
R4	CRCW04022002FKEYE3	Vishay ⁽⁴⁾	Resistor, 20k, 0402, 1%	1
R5	Open(CRCW06031003FRT1)	Vishay ⁽⁴⁾	Resistor, 100k, 0603, 1%	1
R6	CRCW060349R9FKEA	Vishay ⁽⁴⁾	49.9 Ω Resistor, 1%, Size 0603	1
R7	CRCW06032R20FKEA	Vishay ⁽⁴⁾	2.2 Ω Resistor, 1%, Size 0603	1
Q1	Open(2N7002E)	Central Semiconductor ⁽⁸⁾	Signal MOSFET – SOT23-6	1
	Open(CMDPM7002A)			
U1	MIC22705YML	Micrel, Inc. ⁽⁶⁾	1MHz, 7A Integrated Switch High-Efficiency Synchronous Buck Regulator	1

Notes:

1. TDK: www.tdk.com.
2. AVX: www.avx.com.
3. Murata: www.murata.com.
4. Vishay Tel: www.vishay.com.
5. BC Components: www.bccomponents.com.
6. Coiltronics: www.coiltronics.com.
7. Epcos: www.epcos.com.
8. Central Semiconductor: www.centalsemi.com.
9. **Micrel, Inc.:** www.micrel.com.

Evaluation Board PCB Layout

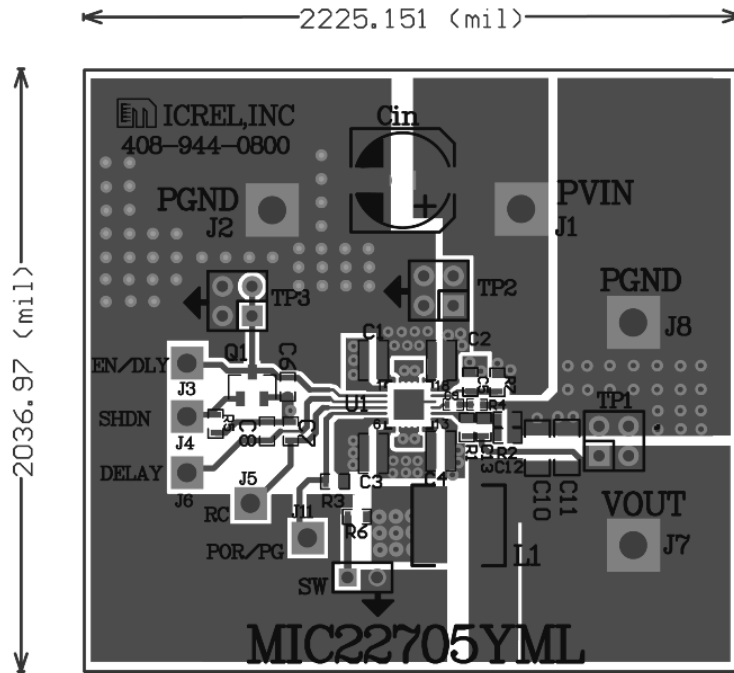

MIC22705 Evaluation Board Top Layer

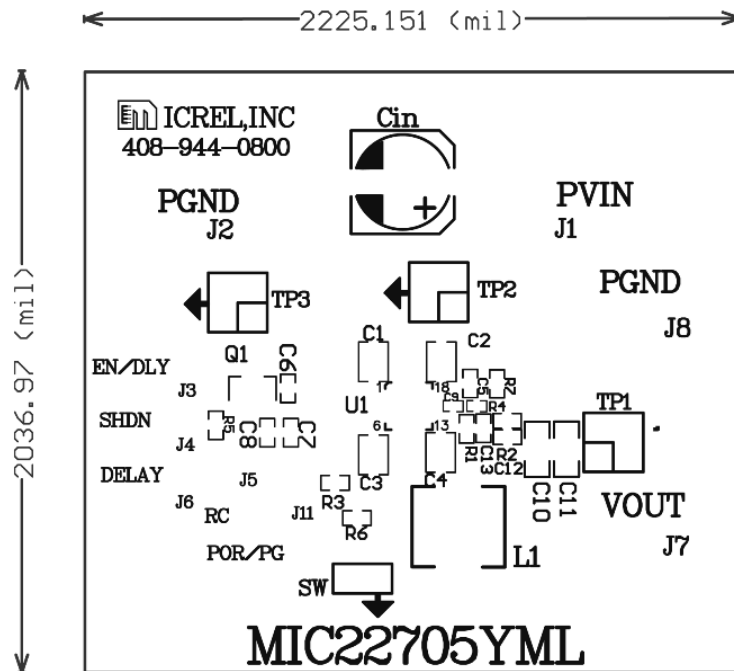

MIC22705 Evaluation Board Top Silk

Evaluation Board PCB Layout (Continued)

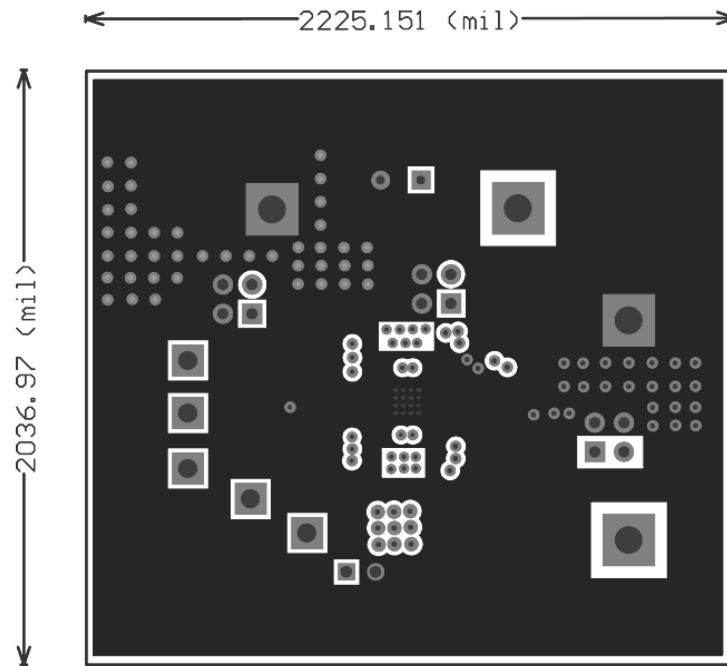

MIC22705 Evaluation Board Mid-Layer 1 (Ground Plane)

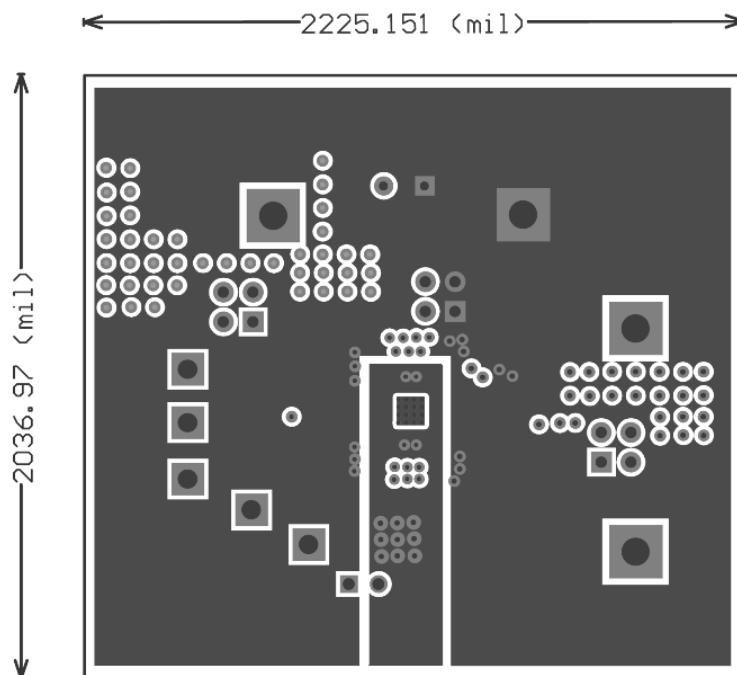

MIC22705 Evaluation Board Mid-Layer 2

Evaluation Board PCB Layout (Continued)

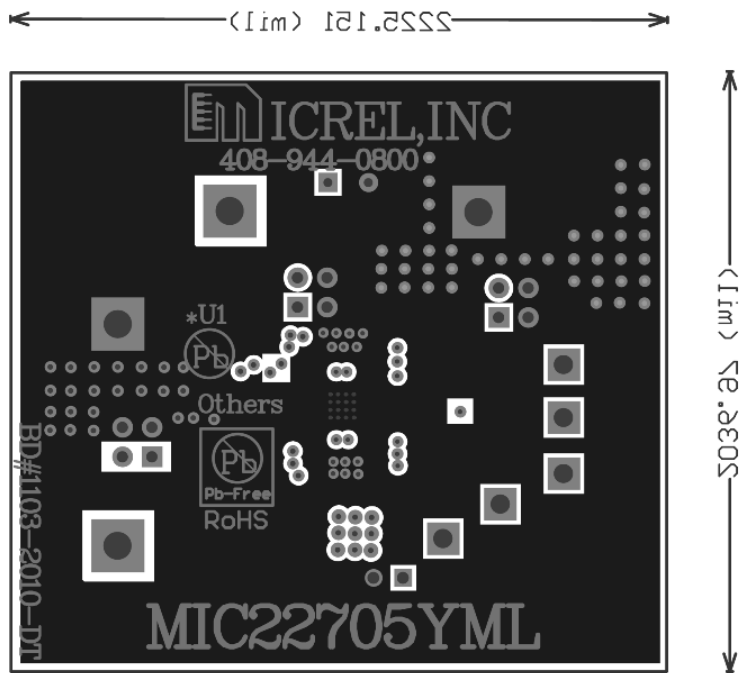

MIC22705 Evaluation Board Bottom Layer

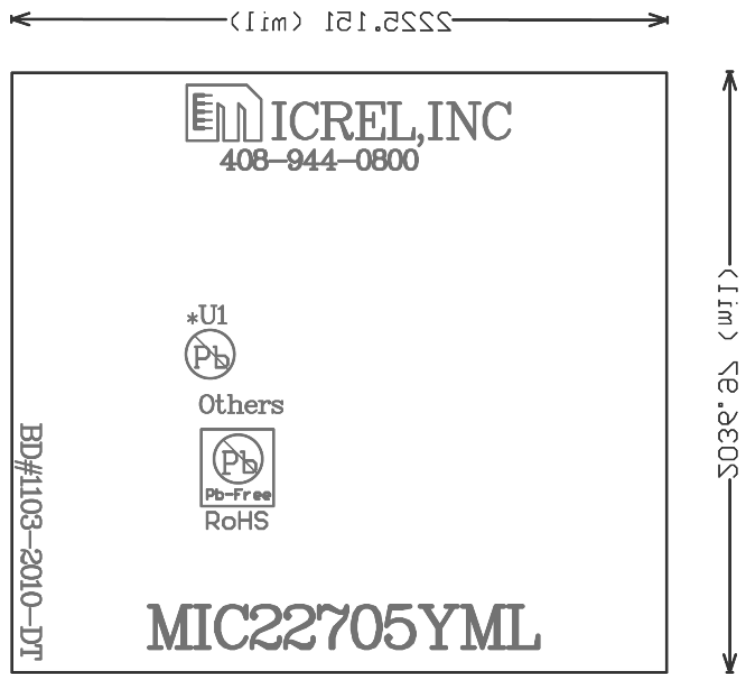

MIC22705 Evaluation Board Bottom Silk

MICREL, INC. 2180 FORTUNE DRIVE SAN JOSE, CA 95131 USA
TEL +1 (408) 944-0800 FAX +1 (408) 474-1000 WEB <http://www.micrel.com>

Micrel makes no representations or warranties with respect to the accuracy or completeness of the information furnished in this data sheet. This information is not intended as a warranty and Micrel does not assume responsibility for its use. Micrel reserves the right to change circuitry, specifications and descriptions at any time without notice. No license, whether express, implied, arising by estoppel or otherwise, to any intellectual property rights is granted by this document. Except as provided in Micrel's terms and conditions of sale for such products, Micrel assumes no liability whatsoever, and Micrel disclaims any express or implied warranty relating to the sale and/or use of Micrel products including liability or warranties relating to fitness for a particular purpose, merchantability, or infringement of any patent, copyright or other intellectual property right.

Micrel Products are not designed or authorized for use as components in life support appliances, devices or systems where malfunction of a product can reasonably be expected to result in personal injury. Life support devices or systems are devices or systems that (a) are intended for surgical implant into the body or (b) support or sustain life, and whose failure to perform can be reasonably expected to result in a significant injury to the user. A Purchaser's use or sale of Micrel Products for use in life support appliances, devices or systems is a Purchaser's own risk and Purchaser agrees to fully indemnify Micrel for any damages resulting from such use or sale.

© 2011 Micrel, Incorporated.