



Chipsmall Limited consists of a professional team with an average of over 10 year of expertise in the distribution of electronic components. Based in Hongkong, we have already established firm and mutual-benefit business relationships with customers from,Europe,America and south Asia,supplying obsolete and hard-to-find components to meet their specific needs.

With the principle of "Quality Parts,Customers Priority,Honest Operation,and Considerate Service",our business mainly focus on the distribution of electronic components. Line cards we deal with include Microchip,ALPS,ROHM,Xilinx,Pulse,ON,Everlight and Freescale. Main products comprise IC,Modules,Potentiometer,IC Socket,Relay,Connector.Our parts cover such applications as commercial,industrial, and automotives areas.

We are looking forward to setting up business relationship with you and hope to provide you with the best service and solution. Let us make a better world for our industry!



## Contact us

Tel: +86-755-8981 8866 Fax: +86-755-8427 6832

Email & Skype: info@chipsmall.com Web: www.chipsmall.com

Address: A1208, Overseas Decoration Building, #122 Zhenhua RD., Futian, Shenzhen, China





# MIC28304

## 70V 3A Power Module

### Hyper Speed Control™ Family



### Hyper Speed Control™

## General Description

Micrel's MIC28304 is synchronous step-down regulator module, featuring a unique adaptive ON-time control architecture. The module incorporates a DC/DC controller, power MOSFETs, bootstrap diode, bootstrap capacitor and an inductor in a single package. The MIC28304 operates over an input supply range from 4.5V to 70V and can be used to supply up to 3A of output current. The output voltage is adjustable down to 0.8V with a guaranteed accuracy of  $\pm 1\%$ . The device operates with programmable switching frequency from 200kHz to 600kHz.

Micrel's HyperLight Load® architecture provides the same high-efficiency and ultra-fast transient response as the Hyper Speed Control™ architecture under the medium to heavy loads, but also maintains high efficiency under light load conditions by transitioning to variable frequency, discontinuous-mode operation.

The MIC28304 offers a full suite of protection features. These include undervoltage lockout, internal soft-start, foldback current limit, "hiccup" mode short-circuit protection, and thermal shutdown.

Datasheets and support documentation are available on Micrel's web site at: [www.micrel.com](http://www.micrel.com).

## Features

- Easy to use
  - Stable with low-ESR ceramic output capacitor
  - No compensation and no inductor to choose
- 4.5V to 70V input voltage
- Single-supply operation
- Power Good (PG) output
- Low radiated emission (EMI) per EN55022, Class B
- Adjustable current limit
- Adjustable output voltage from 0.9V to 24V (also limited by duty cycle)
- 200kHz to 600kHz, programmable switching frequency
- Supports safe start-up into a pre-biased output
- $-40^{\circ}\text{C}$  to  $+125^{\circ}\text{C}$  junction temperature range
- Available in 64-pin, 12mm  $\times$  12mm  $\times$  3mm QFN package

## Applications

- Distributed power systems
- Industrial, medical, telecom, and automotive

## Typical Application

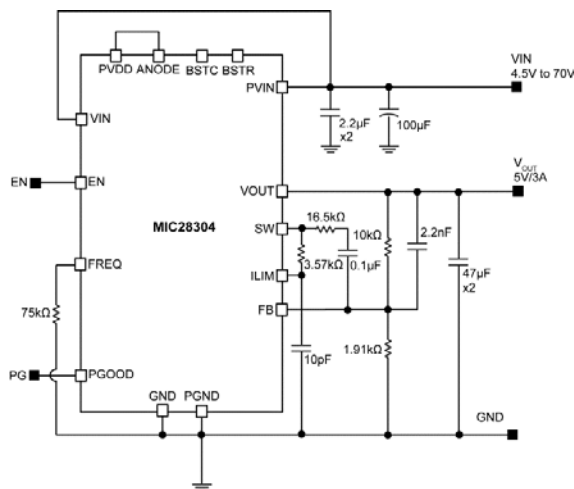

Efficiency vs. Output Current (MIC28304-1)

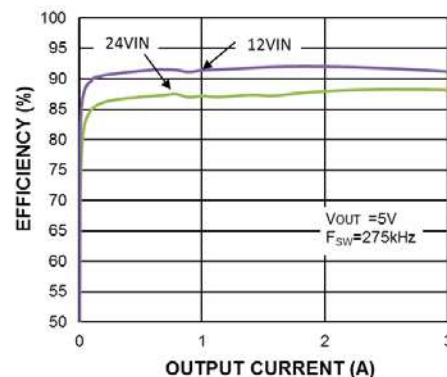

Hyper Speed Control and Any Capacitor are trademarks of Micrel, Inc.

HyperLight Load is a registered trademark of Micrel, Inc.

Micrel Inc. • 2180 Fortune Drive • San Jose, CA 95131 • USA • tel +1 (408) 944-0800 • fax +1 (408) 474-1000 • <http://www.micrel.com>

## Ordering Information

Part Number	Switching Frequency	Features	Package	Junction Temperature Range	Lead Finish
MIC28304-1YMP	200kHz to 600kHz	HyperLight Load	64-pin 12mm × 12mm QFN	-40°C to +125°C	Pb-Free
MIC28304-2YMP	200kHz to 600kHz	Hyper Speed Control	64-pin 12mm × 12mm QFN	-40°C to +125°C	Pb-Free

## Pin Configuration

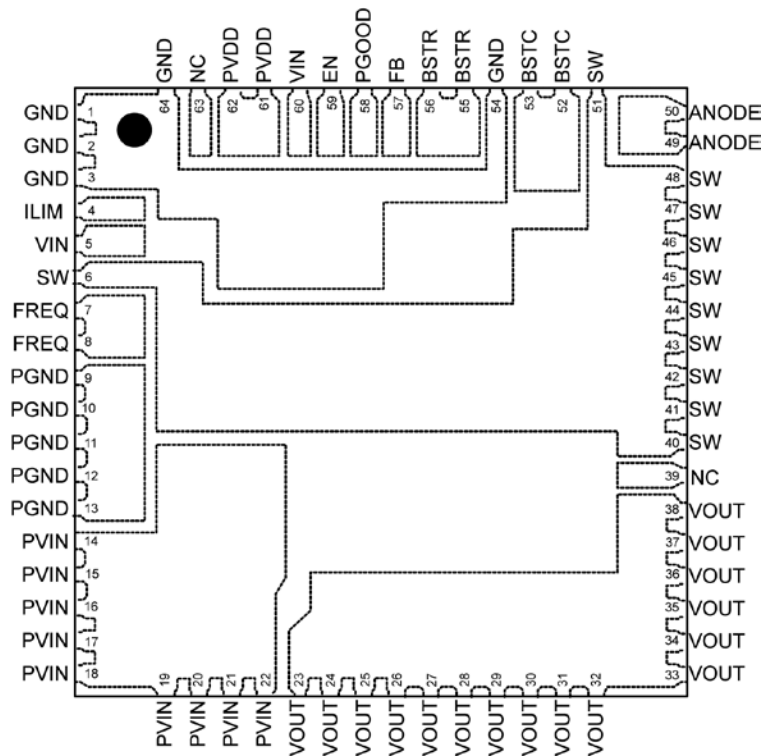

**64-Pin 12mm × 12mm QFN (MP)  
(Top View)**

## Pin Description

Pin Number	Pin Name	Pin Function
1, 2, 3, 54, 64	GND	Analog Ground. Ground for internal controller and feedback resistor network. The analog ground return path should be separate from the power ground (PGND) return path.
4	ILIM	Current Limit Setting. Connect a resistor from SW (pin #4) to ILIM to set the over-current threshold for the converter.
5, 60	VIN	Supply Voltage for Controller. The VIN operating voltage range is from 4.5V to 70V. A 0.47µF ceramic capacitor from VIN (pin # 60) to AGND is required for decoupling. The pin # 5 should be externally connected to either PVIN or pin # 60 on PCB.
6, 40 to 48, 51	SW	Switch Node and Current-Sense Input. High current output driver return. The SW pin connects directly to the switch node. Due to the high-speed switching on this pin, the SW pin should be routed away from sensitive nodes. The SW pin also senses the current by monitoring the voltage across the low-side MOSFET during OFF time.

**Pin Description (Continued)**

Pin Number	Pin Name	Pin Function
7, 8	FREQ	Switching Frequency Adjust Input. Leaving this pin open will set the switching frequency to 600kHz. Alternatively a resistor from this pin to ground can be used to lower the switching frequency.
9 to 13	PGND	Power Ground. PGND is the return path for the buck converter power stage. The PGND pin connects to the sources of low-side N-Channel external MOSFET, the negative terminals of input capacitors, and the negative terminals of output capacitors. The return path for the power ground should be as small as possible and separate from the analog ground (GND) return path.
14 to 22	PVIN	Power Input Voltage. Connection to the drain of the internal high-side power MOSFET.
23 to 38	VOUT	Output Voltage. Connection with the internal inductor, the output capacitor should be connected from this pin to PGND as close to the module as possible.
39	NC	No Connection. Leave it floating.
49, 50	ANODE	Anode Bootstrap Diode Input. Anode connection of internal bootstrap diode, this pin should be connected to the PVDD pin.
52, 53	BSTC	Bootstrap Capacitor. Connection to the internal bootstrap capacitor. Leave floating, no connect.
55, 56	BSTR	Bootstrap Resistor. Connection to the internal bootstrap resistor and high-side power MOSFET drive circuitry. Leave floating, no connect.
57	FB	Feedback Input. Input to the transconductance amplifier of the control loop. The FB pin is regulated to 0.8V. A resistor divider connecting the feedback to the output is used to set the desired output voltage.
58	PGOOD	Power Good Output. Open drain output, an external pull-up resistor to external power rails is required.
59	EN	Enable Input. A logic signal to enable or disable the buck converter operation. The EN pin is CMOS compatible. Logic high enables the device, logic low shutdowns the regulator. In the disable mode, the input supply current for the device is minimized to 4 $\mu$ A typically. Do not pull EN to PVDD.
61, 62	PVDD	Internal +5V Linear Regulator Output. PVDD is the internal supply bus for the device. In the applications with VIN < +5.5V, PVDD should be tied to VIN to by-pass the linear regulator.
63	NC	No Connection. Leave it floating.

**Absolute Maximum Ratings<sup>(1)</sup>**

PVIN, VIN to PGND .....	-0.3V to +76V
PVDD, V <sub>ANODE</sub> to PGND .....	-0.3V to +6V
V <sub>SW</sub> , V <sub>FREQ</sub> , V <sub>ILIM</sub> , V <sub>EN</sub> .....	-0.3V to (PVIN +0.3V)
V <sub>BSTC/BSTR</sub> to V <sub>SW</sub> .....	-0.3V to 6V
V <sub>BSTC/BSTR</sub> to PGND.....	-0.3V to 82V
V <sub>FB</sub> , V <sub>PG</sub> to PGND .....	-0.3V to (PVDD + 0.3V)
PGND to AGND.....	-0.3V to +0.3V
Junction Temperature .....	+150°C
Storage Temperature (T <sub>S</sub> ).....	-65°C to +150°C
Lead Temperature (soldering, 10s).....	260°C
ESD Rating <sup>(3)</sup> .....	ESD Sensitive

**Operating Ratings<sup>(2)</sup>**

Supply Voltage (PVIN, VIN) .....	4.5V to 70V
Enable Input (V <sub>EN</sub> ) .....	0V to VIN
V <sub>SW</sub> , V <sub>FREQ</sub> , V <sub>ILIM</sub> , V <sub>EN</sub> .....	0V to VIN
Power Good (V <sub>PGOOD</sub> ).....	0V to PVDD
Junction Temperature (T <sub>J</sub> ) .....	-40°C to +125°C
Junction Thermal Resistance	
12mm × 12mm QFN-64 (θ <sub>JA</sub> ) .....	20°C/W
12mm × 12mm QFN-64 (θ <sub>JC</sub> ).....	5°C/W

**Electrical Characteristics<sup>(4)</sup>**

PVIN = VIN = 12V, V<sub>OUT</sub> = 5V, V<sub>BST</sub> - V<sub>SW</sub> = 5V; T<sub>A</sub> = 25°C, unless noted. **Bold** values indicate -40°C ≤ T<sub>J</sub> ≤ +125°C.

Parameter	Condition	Min.	Typ.	Max.	Units
<b>Power Supply Input</b>					
Input Voltage Range (PVIN, VIN)		<b>4.5</b>		<b>70</b>	V
Controller Supply Current <sup>(5)</sup>	Current into Pin 60; VFB = 1.5V (MIC28304-1)		0.4	<b>0.75</b>	mA
	Current into Pin 60; VFB = 1.5V (MIC28304-2)		2.1	<b>3</b>	
	Current into Pin 60; V <sub>EN</sub> = 0V			0.1	<b>10</b>
Operating Current	I <sub>OUT</sub> = 0A (MIC28304-1)		0.7		mA
	I <sub>OUT</sub> = 0A (MIC28304-2)		27		
Shutdown Supply Current	PVIN = VIN = 12V, V <sub>EN</sub> = 0V		4		μA
<b>PVDD Supply<sup>(5)</sup></b>					
PVDD Output Voltage	VIN = 7V to 70V, I <sub>PVDD</sub> = 10mA	<b>4.8</b>	5.2	<b>5.4</b>	V
PVDD UVLO Threshold	PVDD rising	<b>3.8</b>	4.2	<b>4.7</b>	V
PVDD UVLO Hysteresis			400		mV
Load Regulation	I <sub>PVDD</sub> = 0 to 40mA	0.6	2	3.6	%
<b>Reference<sup>(5)</sup></b>					
Feedback Reference Voltage	T <sub>J</sub> = 25°C (±1.0%)	0.792	0.8	0.808	V
	-40°C ≤ T <sub>J</sub> ≤ 125°C (±2%)	<b>0.784</b>	<b>0.8</b>	<b>0.816</b>	
FB Bias Current	V <sub>FB</sub> = 0.8V		5	<b>500</b>	nA

**Notes:**

- Exceeding the absolute maximum ratings may damage the device.
- The device is not guaranteed to function outside its operating ratings.
- Devices are ESD sensitive. Handling precautions are recommended. Human body model, 1.5kΩ in series with 100pF.
- Specification for packaged product only.
- IC tested prior to assembly.

## Electrical Characteristics<sup>(4)</sup> (Continued)

PVIN = VIN = 12V, V<sub>OUT</sub> = 5V, V<sub>BST</sub> - V<sub>SW</sub> = 5V; T<sub>A</sub> = 25°C, unless noted. **Bold** values indicate -40°C ≤ T<sub>J</sub> ≤ +125°C.

Parameter	Condition	Min.	Typ.	Max.	Units
<b>Enable Control</b>					
EN Logic Level High		<b>1.8</b>			V
EN Logic Level Low				<b>0.6</b>	V
EN Hysteresis			200		mV
EN Bias Current	V <sub>EN</sub> = 12V		5	<b>20</b>	μA
<b>Oscillator</b>					
Switching Frequency	FREQ pin = open	<b>400</b>	600	<b>750</b>	kHz
	RFREQ = 100kΩ (FREQ pin-to-GND)		300		
Maximum Duty Cycle			85		%
Minimum Duty Cycle	V <sub>FB</sub> > 0.8V		0		%
Minimum Off-Time		140	200	260	ns
<b>Soft-Start<sup>(5)</sup></b>					
Soft-Start Time			5		ms
<b>Short-Circuit Protection<sup>(5)</sup></b>					
Current-Limit Threshold (V <sub>CL</sub> )	V <sub>FB</sub> = 0.79V	-30	-14	0	mV
Short-Circuit Threshold	V <sub>FB</sub> = 0V	-23	-7	9	mV
Current-Limit Source Current	V <sub>FB</sub> = 0.79V	60	80	100	μA
Short-Circuit Source Current	V <sub>FB</sub> = 0V	27	36	47	μA
<b>Leakage</b>					
SW, BSTR Leakage Current				50	μA
<b>Power Good<sup>(5)</sup></b>					
Power Good Threshold Voltage	Sweep V <sub>FB</sub> from low-to-high	<b>85</b>	90	<b>95</b>	%V <sub>OUT</sub>
Power Good Hysteresis	Sweep V <sub>FB</sub> from high-to-low		6		%V <sub>OUT</sub>
Power Good Delay Time	Sweep V <sub>FB</sub> from low-to-high		100		μs
Power Good Low Voltage	V <sub>FB</sub> < 90% × V <sub>NOM</sub> , I <sub>PG</sub> = 1mA		70	<b>200</b>	mV
<b>Thermal Protection</b>					
Overtemperature Shutdown	T <sub>J</sub> Rising		160		°C
Overtemperature Shutdown Hysteresis			4		°C

**Electrical Characteristics<sup>(4)</sup> (Continued)**

PVIN = VIN = 12V, V<sub>OUT</sub> = 5V, V<sub>BST</sub> - V<sub>SW</sub> = 5V; T<sub>A</sub> = 25°C, unless noted. **Bold** values indicate -40°C ≤ T<sub>J</sub> ≤ +125°C.

Parameter	Condition	Min.	Typ.	Max.	Units
<b>Output Characteristic</b>					
Output Voltage Ripple	I <sub>OUT</sub> = 3A		16		mV
Line Regulation	PVIN = VIN = 7V to 70V, I <sub>OUT</sub> = 3A		0.36		%
Load Regulation	I <sub>OUT</sub> = 0A to 3A PVIN= VIN =12V (MIC28304-1)		0.75		%
	I <sub>OUT</sub> = 0A to 3A PVIN= VIN =12V (MIC28304-2)		0.05		
Output Voltage Deviation from Load Step	I <sub>OUT</sub> from 0A to 3A at 5A/μs (MIC28304-1)		400		mV
	I <sub>OUT</sub> from 3A to 0A at 5A/μs (MIC28304-1)		500		
	I <sub>OUT</sub> from 0A to 3A at 5A/μs (MIC28304-2)		400		
	I <sub>OUT</sub> from 3A to 0A at 5A/μs (MIC28304-2)		500		

## Typical Characteristics – 275kHz Switching Frequency

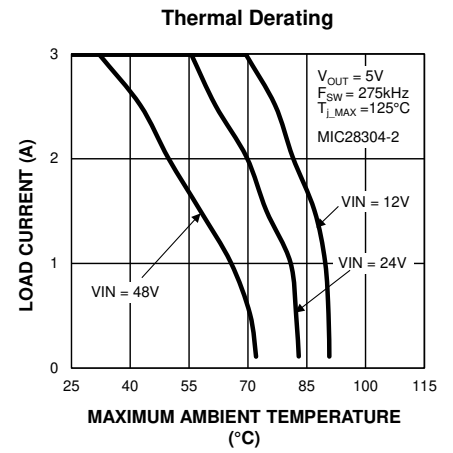
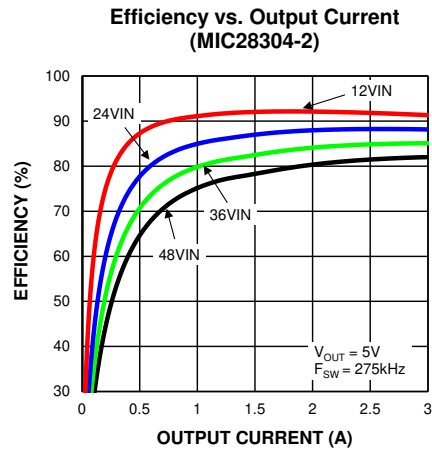
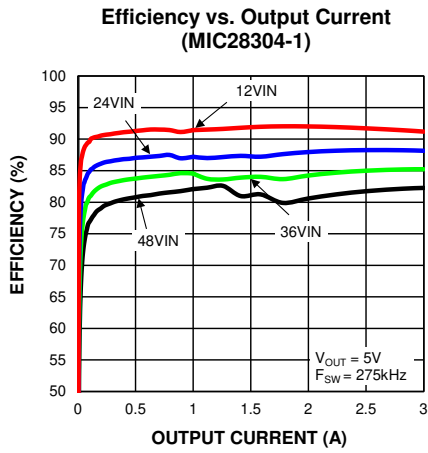

**Table 1. Recommended Component Values for 275kHz Switching Frequency**

V <sub>OUT</sub>	V <sub>IN</sub>	R3 (R <sub>inj</sub> )	R19	R15	R1 (Top Feedback Resistor)	R11 (Bottom Feedback Resistor)	C10 (C <sub>inj</sub> )	C12 (C <sub>ff</sub> )	C <sub>OUT</sub>
5V	7V to 18V	16.5kΩ	75kΩ	3.57k	10kΩ	1.9kΩ	0.1μF	2.2nF	2x47μF/6.3V
5V	18V to 70V	39.2kΩ	75kΩ	3.57k	10kΩ	1.9kΩ	0.1μF	2.2nF	2x 47μF/6.3V
3.3V	5V to 18V	16.5kΩ	75kΩ	3.57k	10kΩ	3.24kΩ	0.1μF	2.2nF	2x 47μF/6.3V
3.3V	18V to 70V	39.2kΩ	75kΩ	3.57k	10kΩ	3.24kΩ	0.1μF	2.2nF	2x 47μF/6.3V



# Typical Characteristics

**VIN Operating Supply Current vs. Input Voltage (MIC28304-1)**

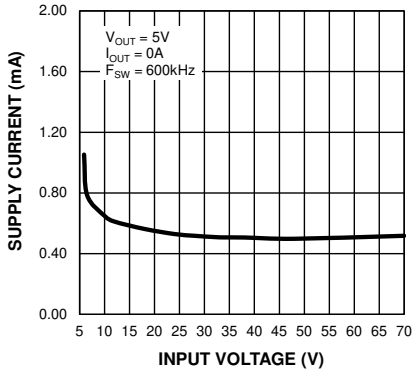

**Output Regulation vs. Input Voltage (MIC28304-1)**

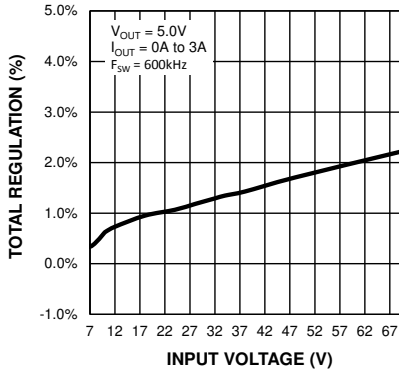

**Feedback Voltage vs. Input Voltage (MIC28304-1)**

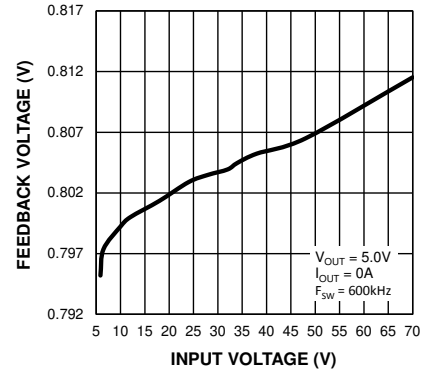

**Output Voltage vs. Input Voltage (MIC28304-1)**

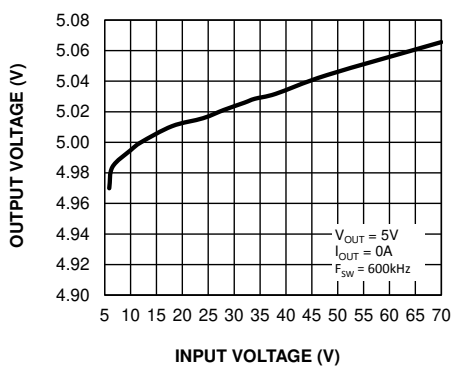

**VIN Operating Supply Current vs. Temperature (MIC28304-1)**

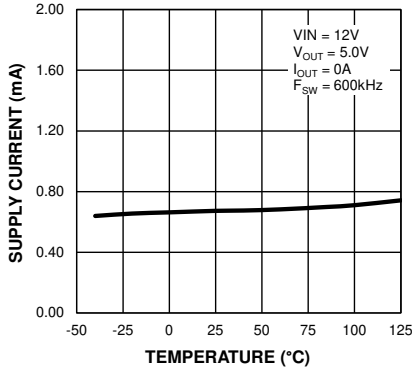

**Feedback Voltage vs. Temperature (MIC28304-1)**

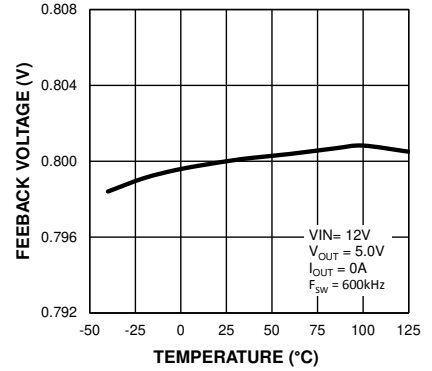

**Load Regulation vs. Temperature (MIC28304-1)**

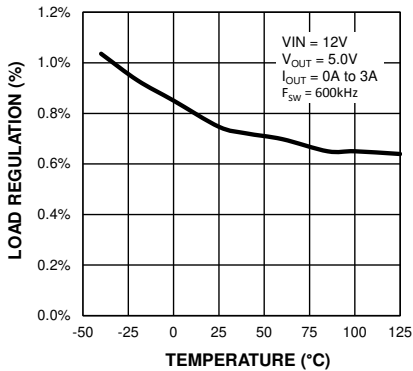

**Line Regulation vs. Temperature (MIC28304-1)**

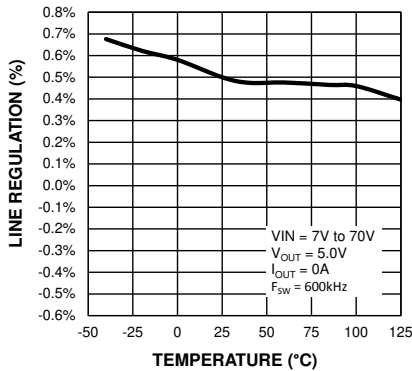

**Line Regulation vs. Temperature (MIC28304-1)**

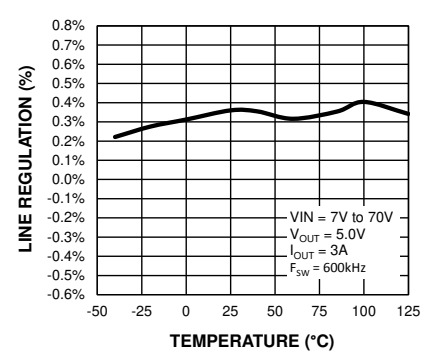

### Typical Characteristics (Continued)

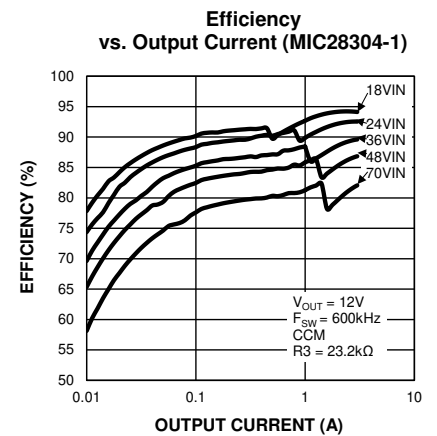
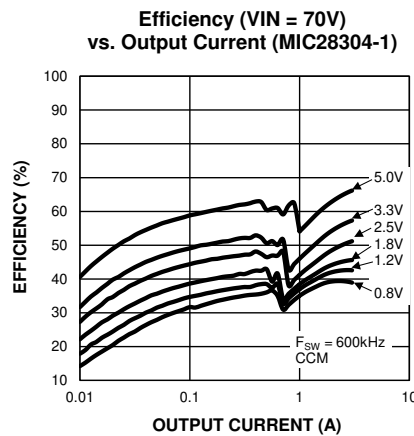
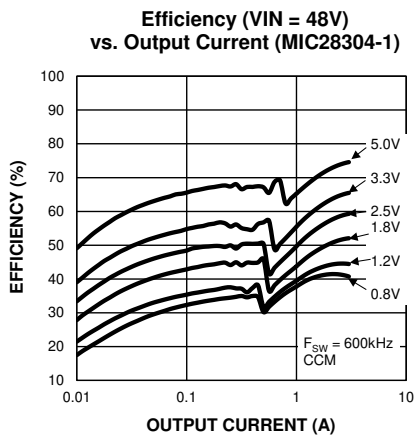
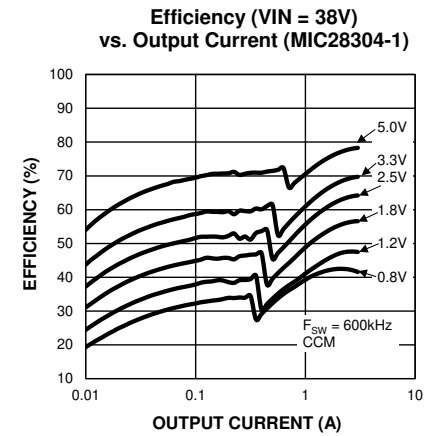
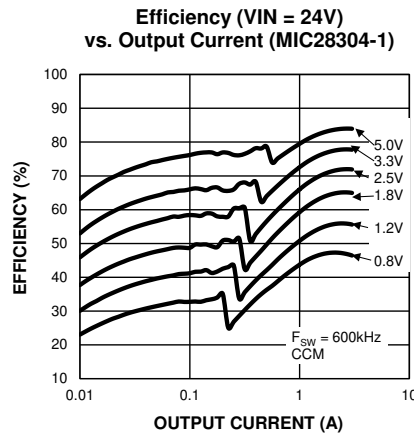
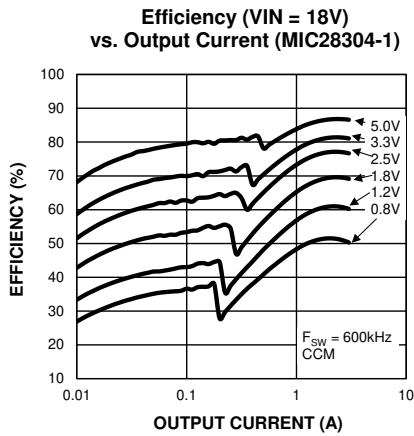
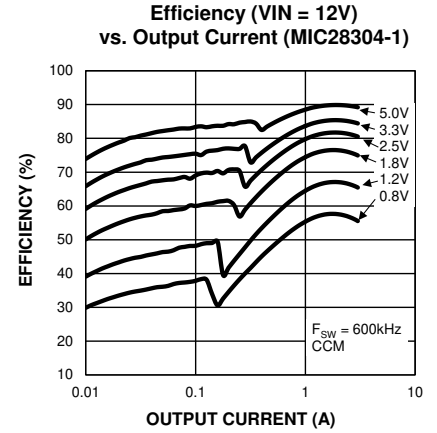
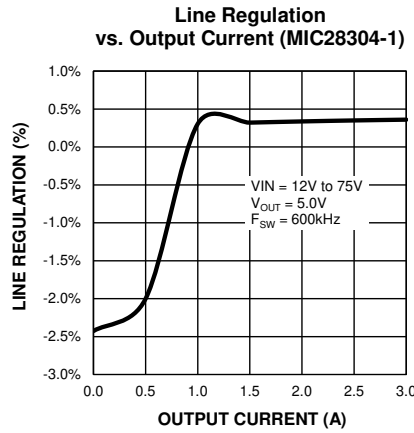
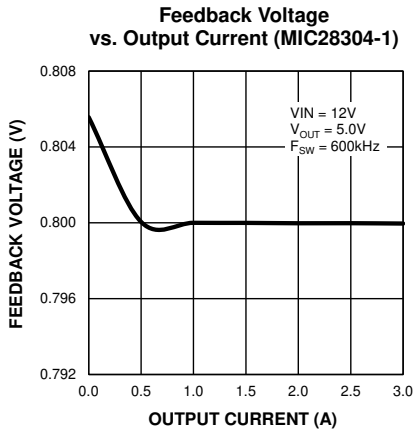

### Typical Characteristics (Continued)

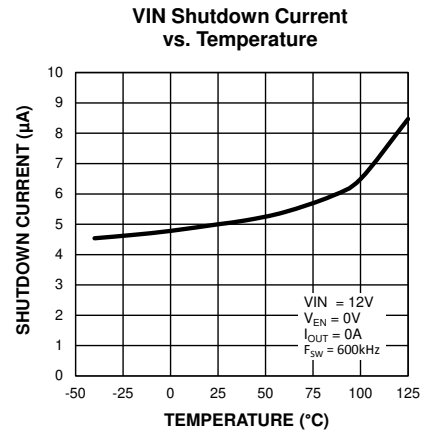
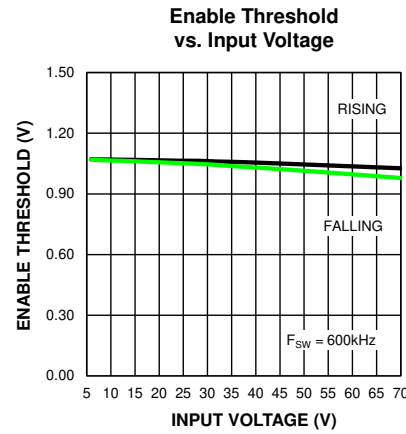
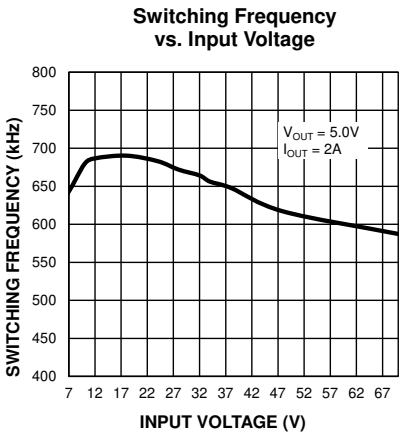
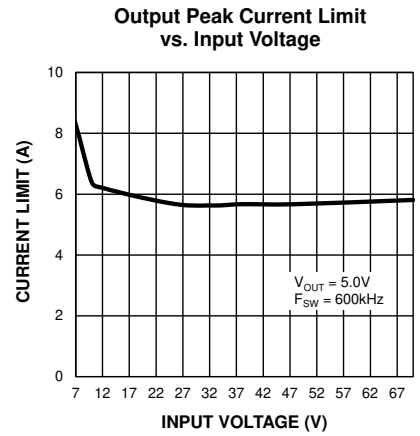
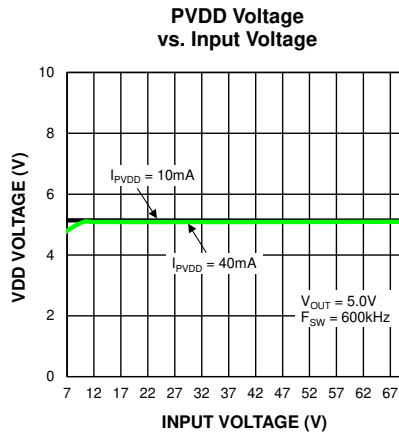
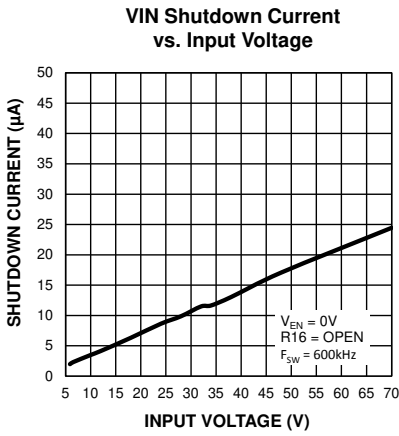
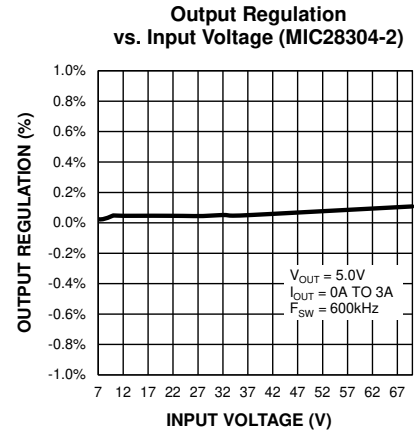
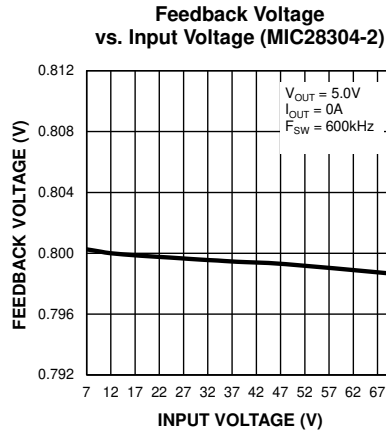
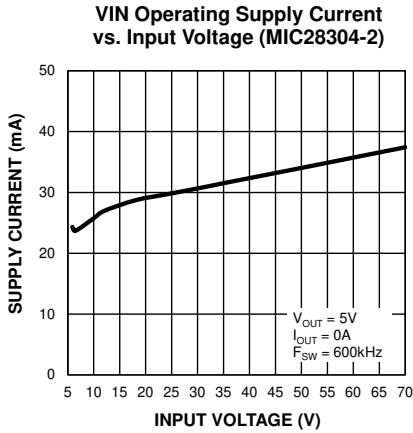

Typical Characteristics (Continued)

PVDD Voltage vs. Temperature

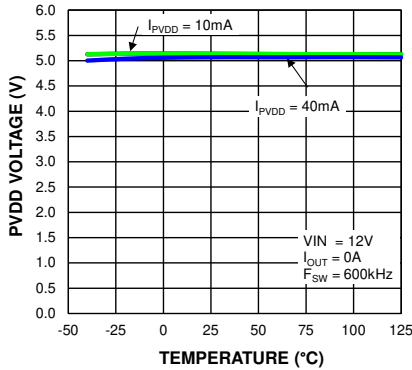

PVDD UVLO Threshold vs. Temperature

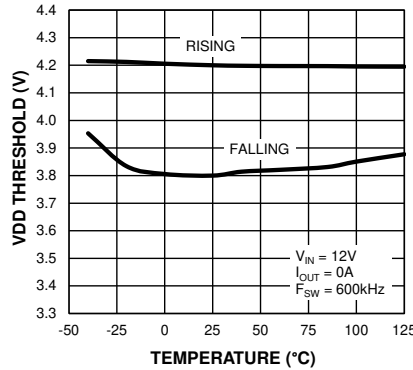

Output Peak Current Limit vs. Temperature

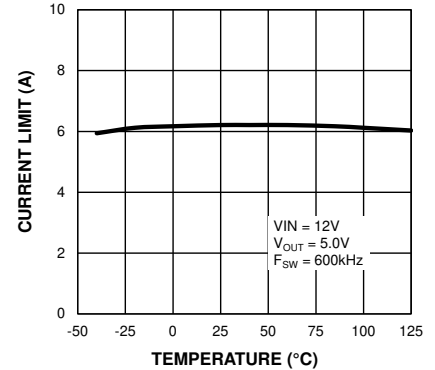

EN Bias Current vs. Temperature

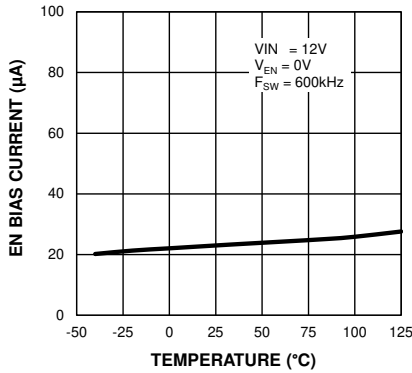

Enable Threshold vs. Temperature

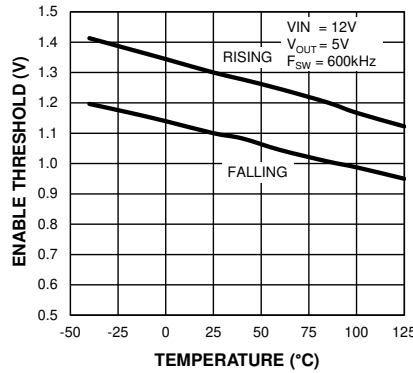

VIN Operating Supply Current vs. Temperature (MIC28304-2)

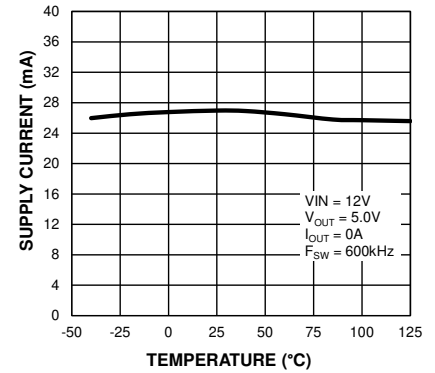

Feedback Voltage vs. Temperature (MIC28304-2)

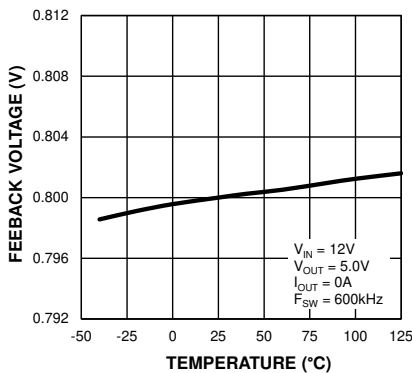

Load Regulation vs. Temperature (MIC28304-2)

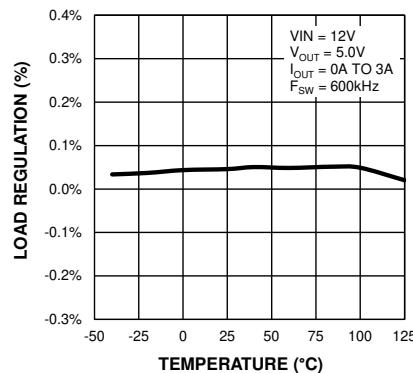

Line Regulation vs. Temperature (MIC28304-2)

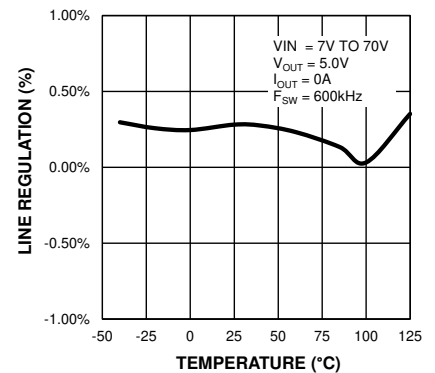

Typical Characteristics (Continued)

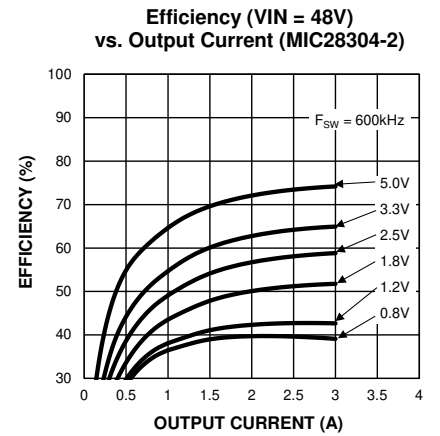
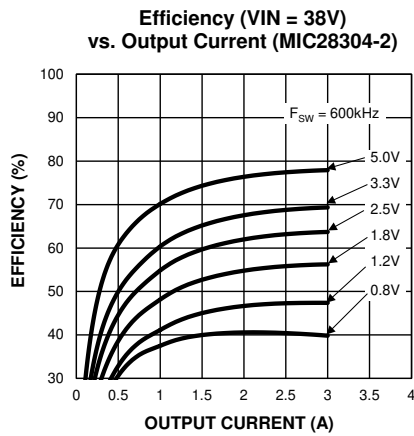
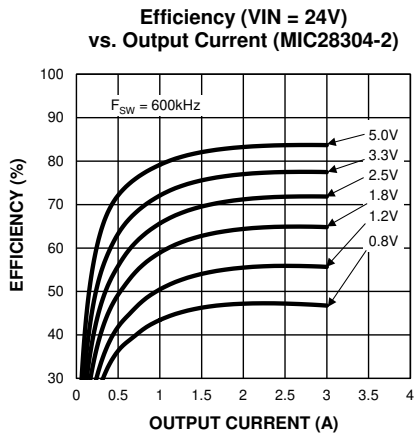
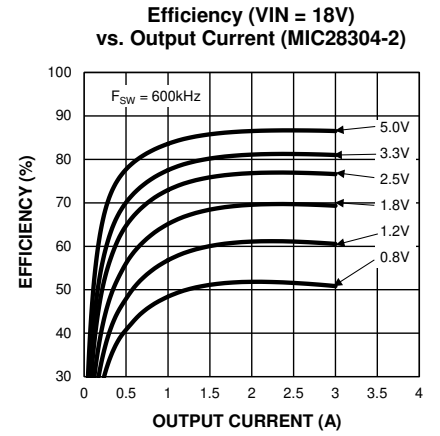
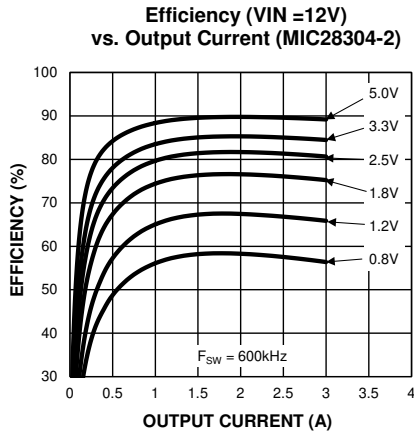
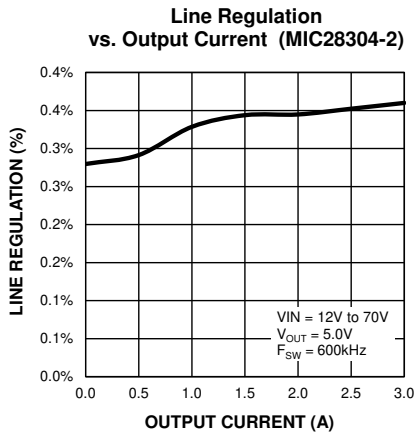
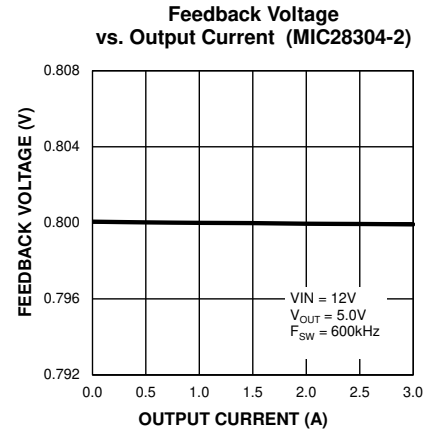
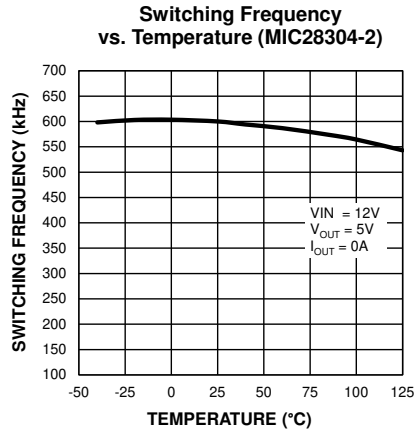
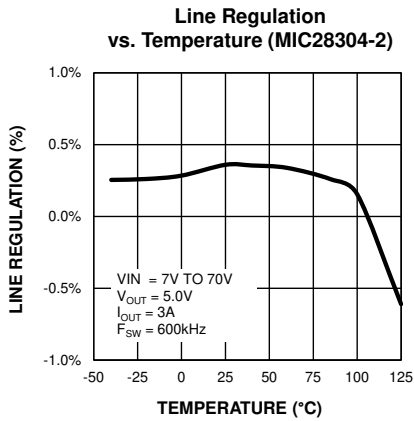

## Typical Characteristics (Continued)

**Efficiency (VIN = 70V)  
vs. Output Current (MIC28304-2)**

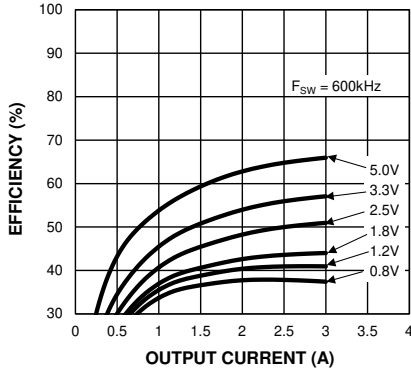

**Die Temperature\* (VIN = 12V)  
vs. Output Current (MIC28304-2)**

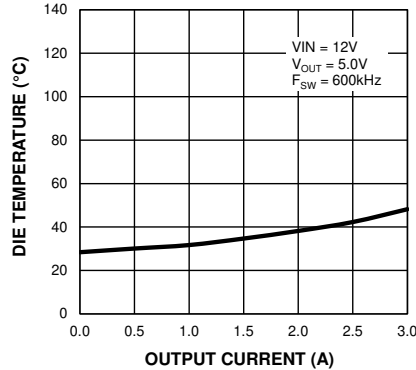

**Die Temperature\* (VIN = 48V)  
vs. Output Current (MIC28304-2)**

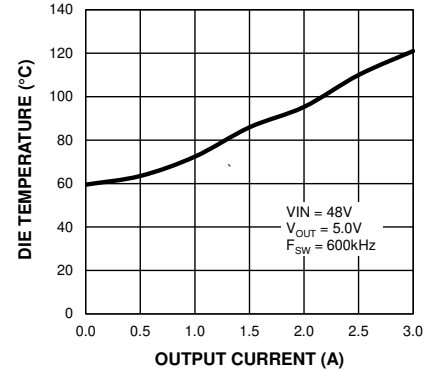

**Die Temperature\* (VIN = 70V)  
vs. Output Current (MIC28304-2)**

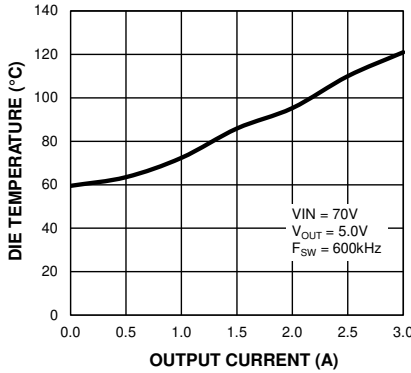

**Switching Frequency**

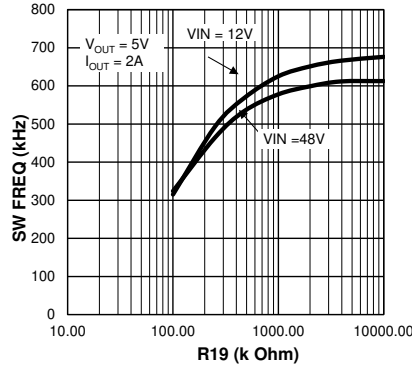

**IC Power Dissipation  
vs. Output Current (MIC28304-2)**

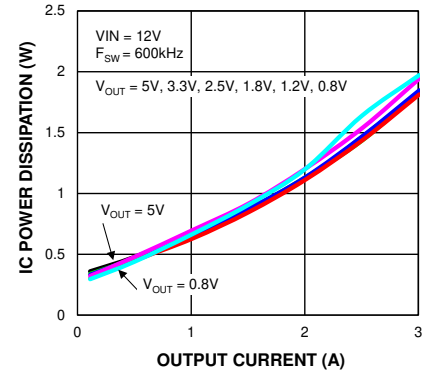

**IC Power Dissipation  
vs. Output Current (MIC28304-2)**

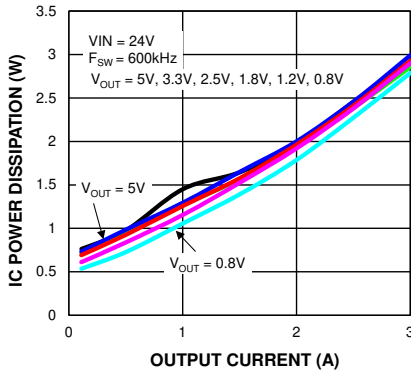

**IC Power Dissipation  
vs. Output Current (MIC28304-2)**

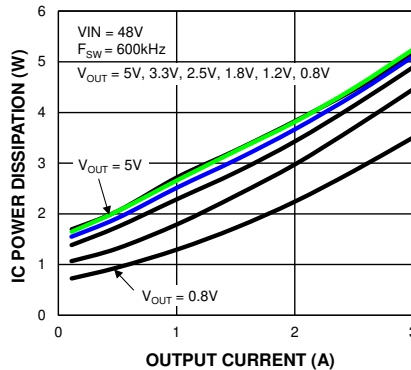

**IC Power Dissipation  
vs. Output Current (MIC28304-2)**

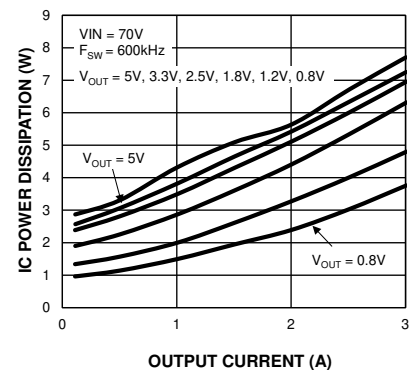

\* **Case Temperature:** The temperature measurement was taken at the hottest point on the MIC28304 case mounted on a 5 square inch PCB (see Thermal Measurement section). Actual results will depend upon the size of the PCB, ambient temperature and proximity to other heat-emitting components.

Typical Characteristics (Continued)

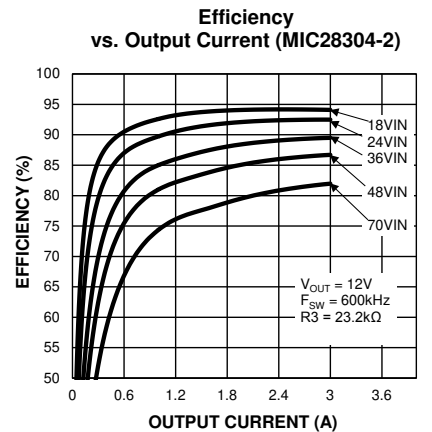
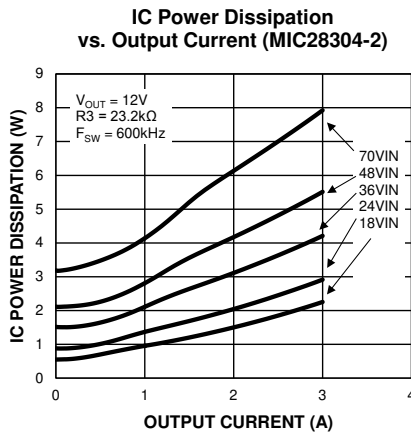
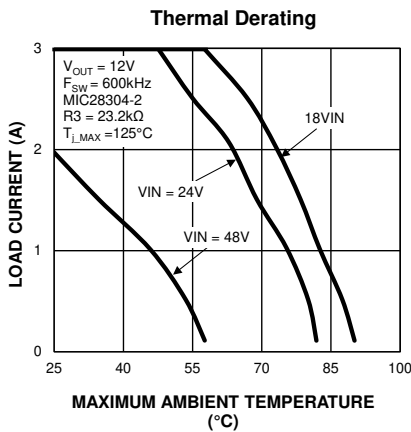
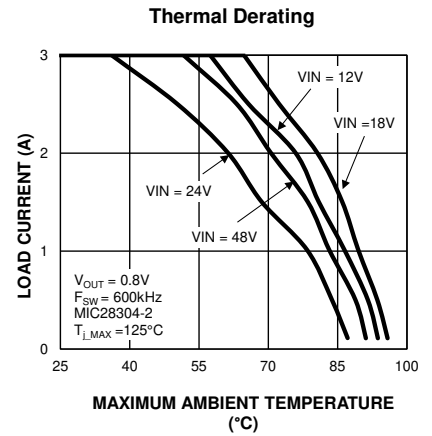
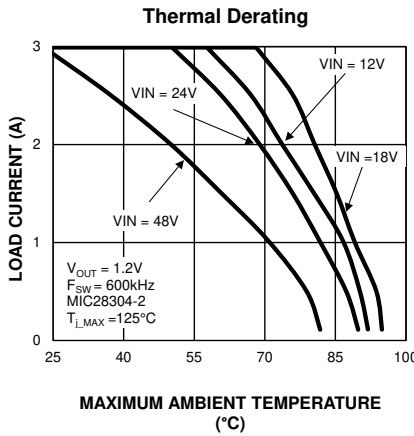
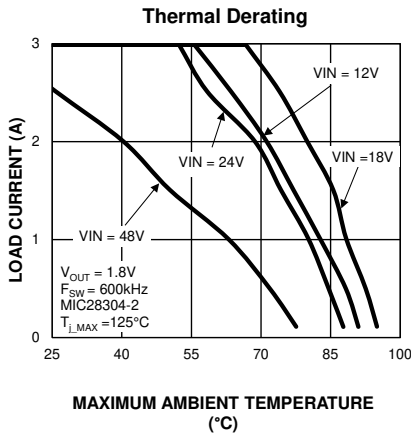
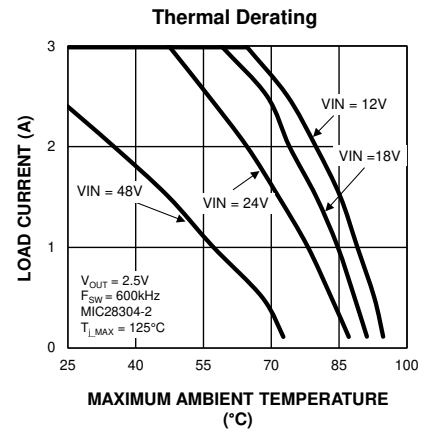
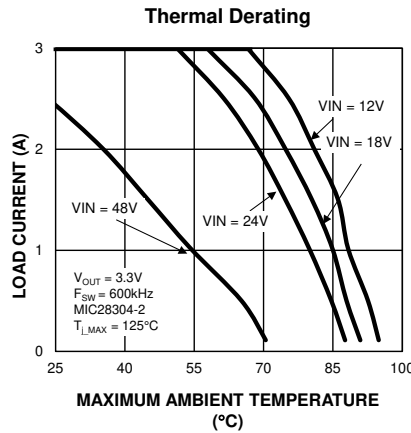
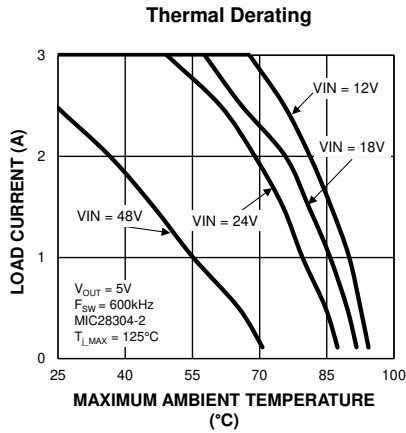

## Functional Characteristics – 600kHz Switching Frequency

VIN Soft Turn-On

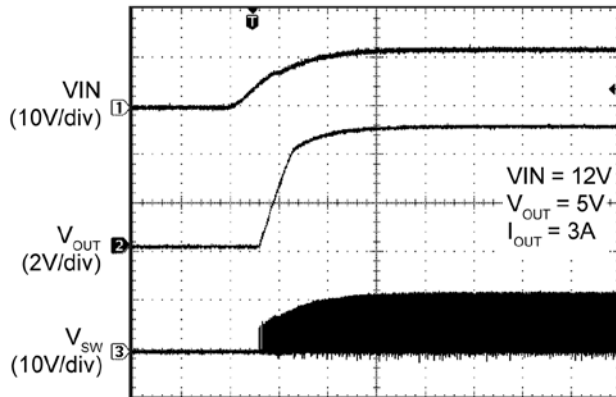

Time (4.0ms/div)

VIN Soft Turn-Off

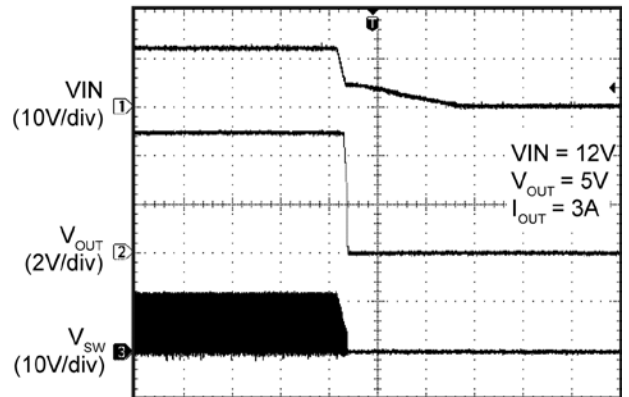

Time (20ms/div)

Enable Turn-On Delay and Rise Time

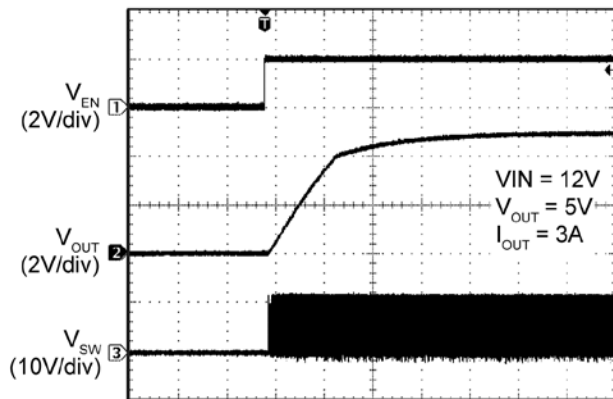

Time (2.0ms/div)

Enable Turn-Off Delay and Fall Time

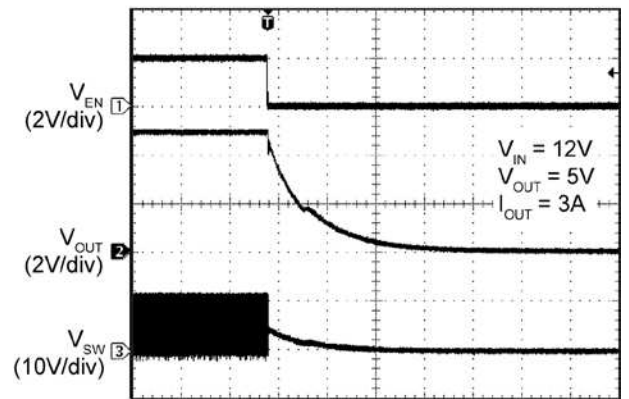

Time (1.0ms/div)

MIC28304-2 VIN Start-Up with Pre-Biased Output

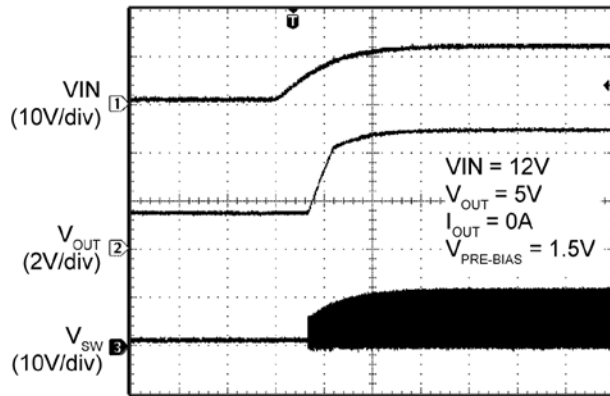

Time (4.0ms/div)

MIC28304-1 VIN Start-Up with Pre-Biased Output

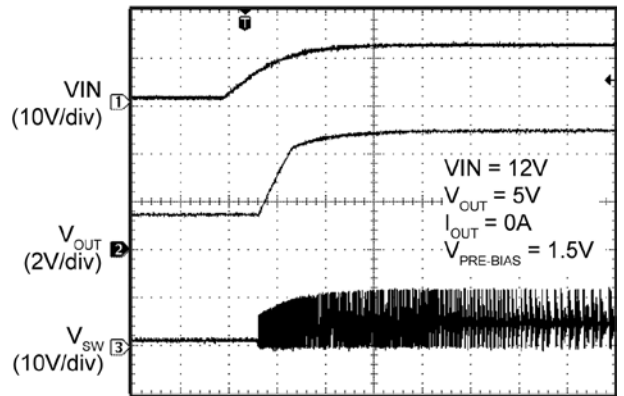

Time (4.0ms/div)



Functional Characteristics – 600kHz Switching Frequency (Continued)

Enable Turn-On/Turn-Off

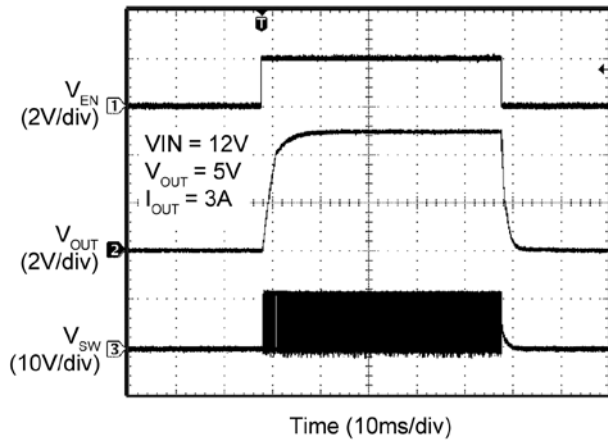

Enable Thresholds

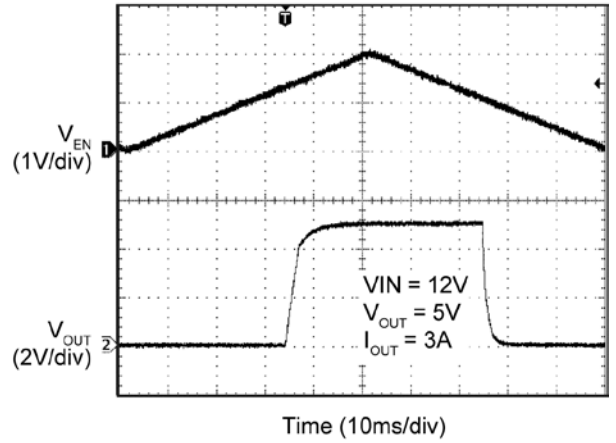

VIN UVLO Thresholds

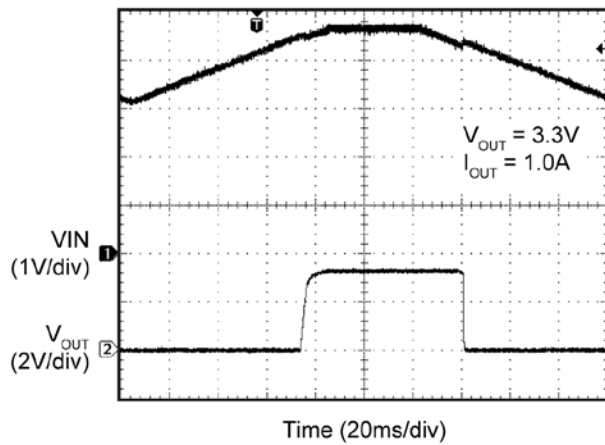

Power-Up into Short Circuit

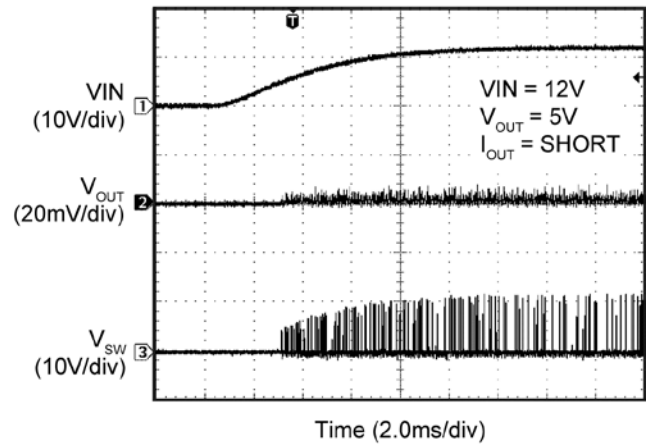

Enabled into Short

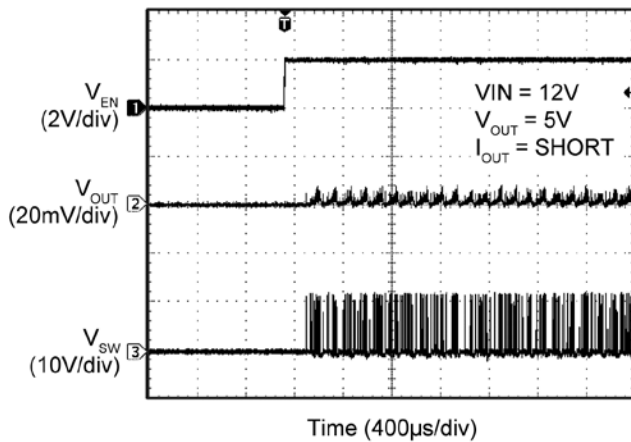

Output Peak Current-Limit Threshold

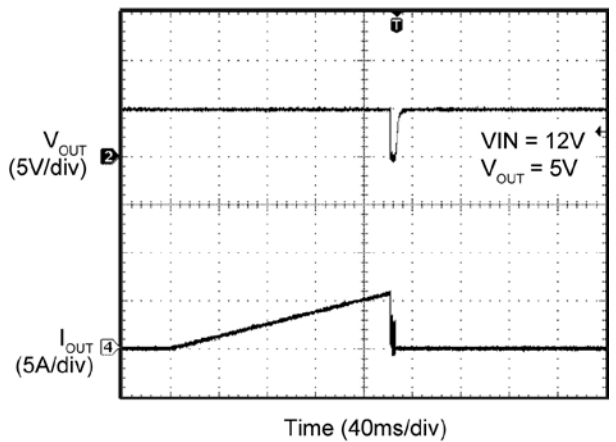

Functional Characteristics – 600kHz Switching Frequency (Continued)

Short Circuit

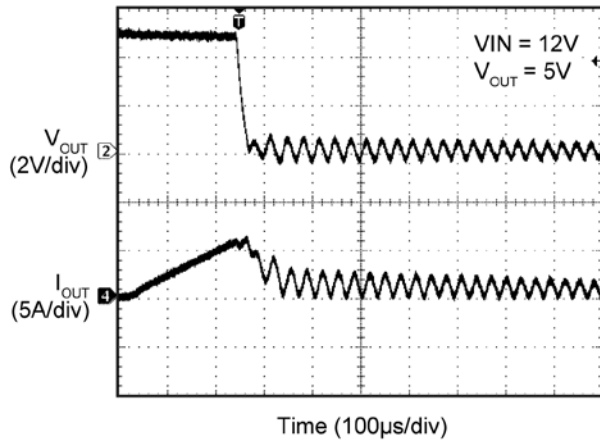

Output Recovery from Short Circuit

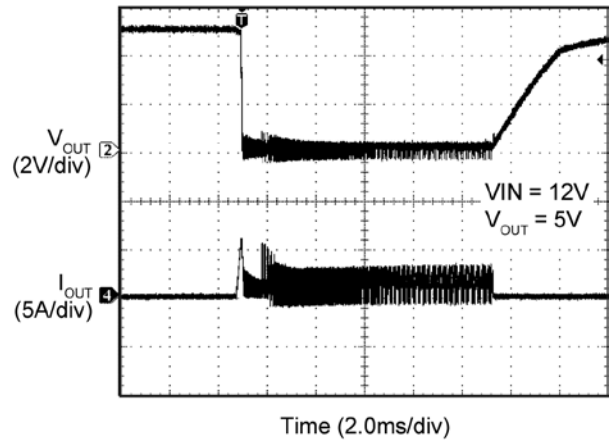

Output Recovery from Thermal Shutdown

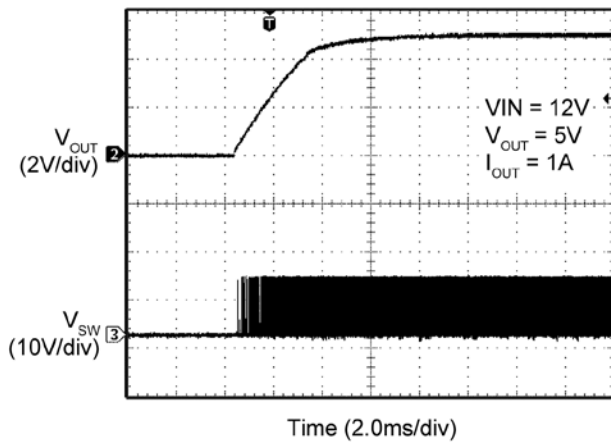

MIC28304-2 Switching Waveforms ( $I_{OUT} = 3A$ )

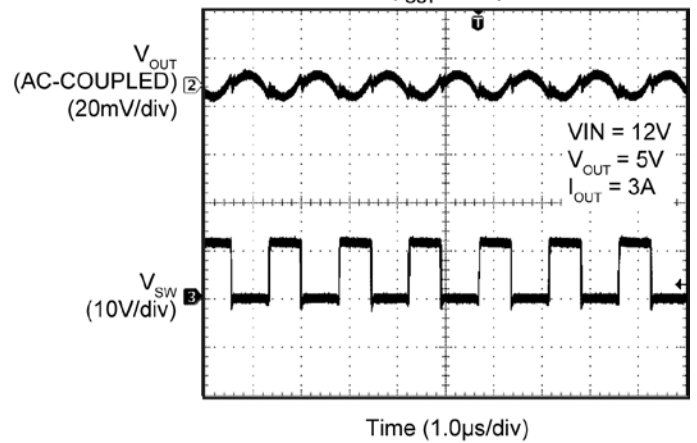

MIC28304-2 Switching Waveforms ( $I_{OUT} = 0A$ )

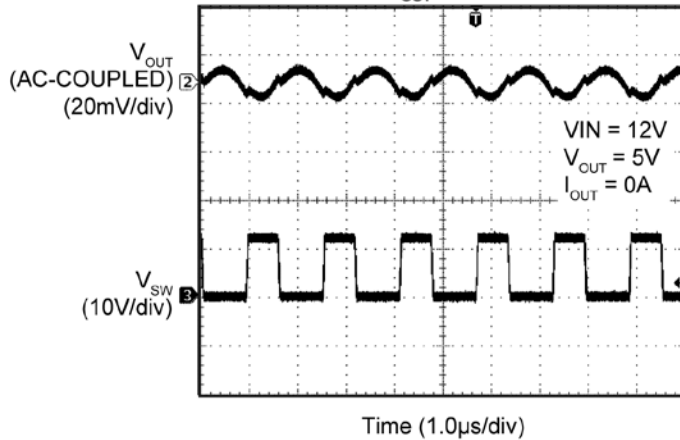

MIC28304-1 Switching Waveforms ( $I_{OUT} = 0A$ )

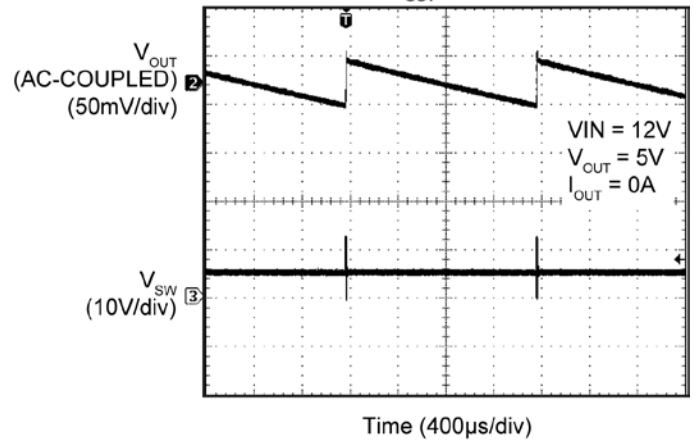

Functional Characteristics – 600kHz Switching Frequency (Continued)

MIC28304-1 Switching Waveforms  
( $I_{OUT} = 3A$ )

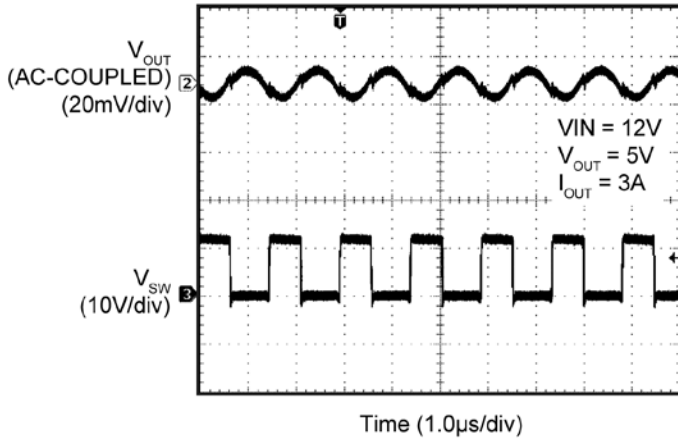

MIC28304-2 Transient Response

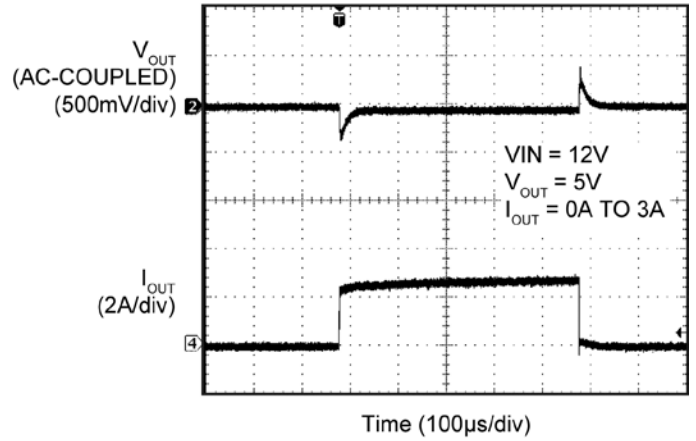

MIC28304-1 Transient Response

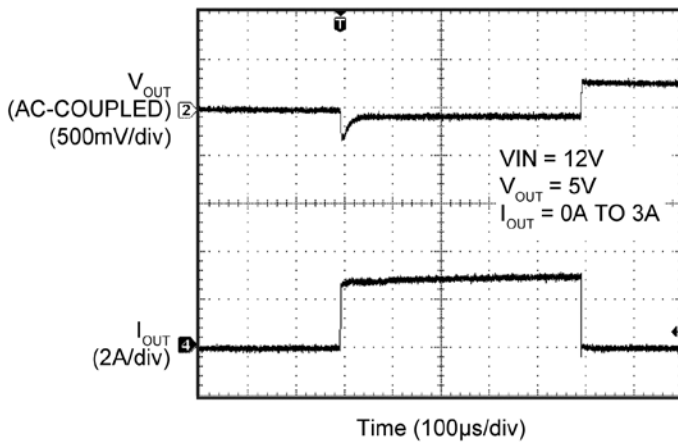

MIC28304-2 Transient Response

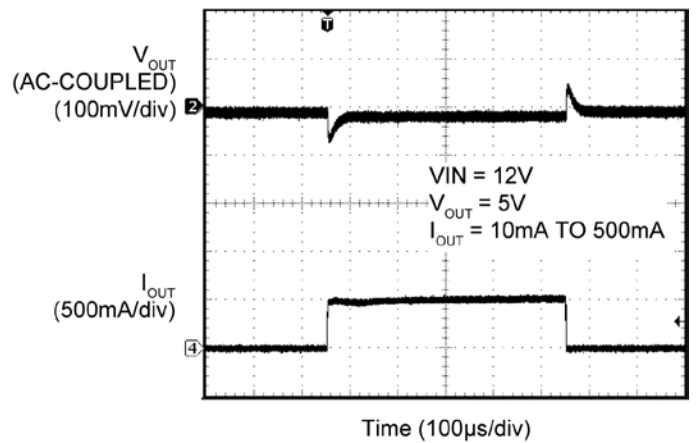

MIC28304-1 Transient Response

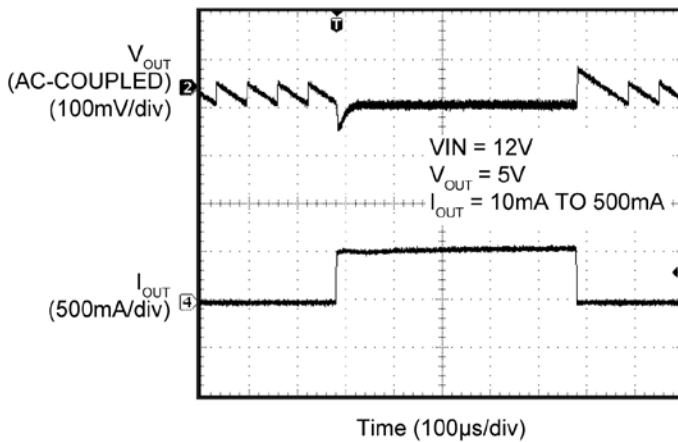

MIC28304-2 Transient Response

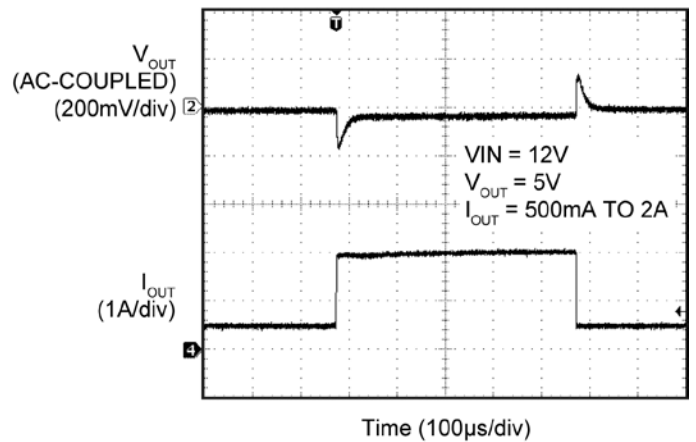

Functional Characteristics – 600kHz Switching Frequency (Continued)

MIC28304-1 Transient Response

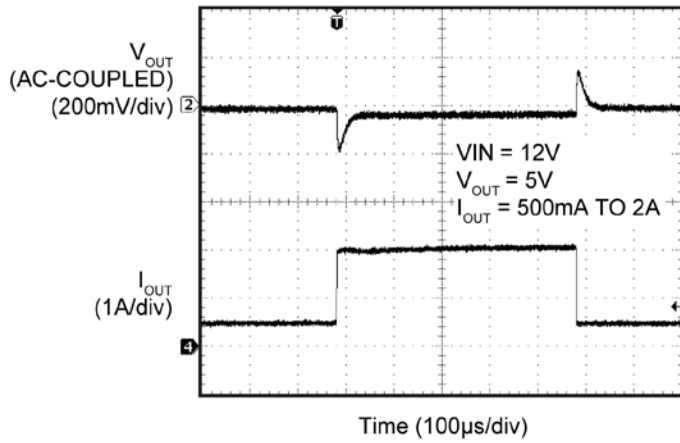

MIC28304-2 Transient Response

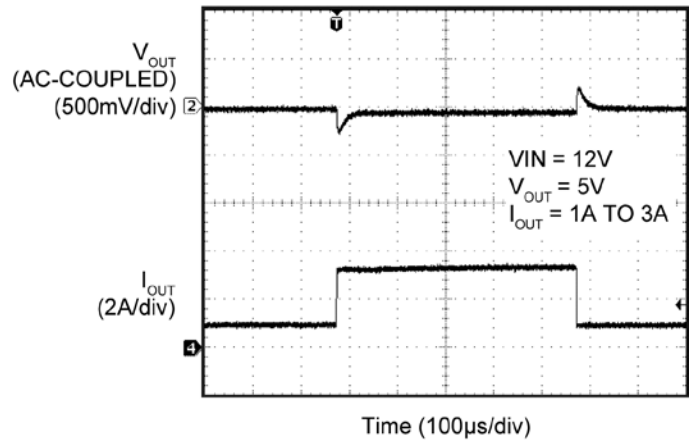

MIC28304-1 Transient Response

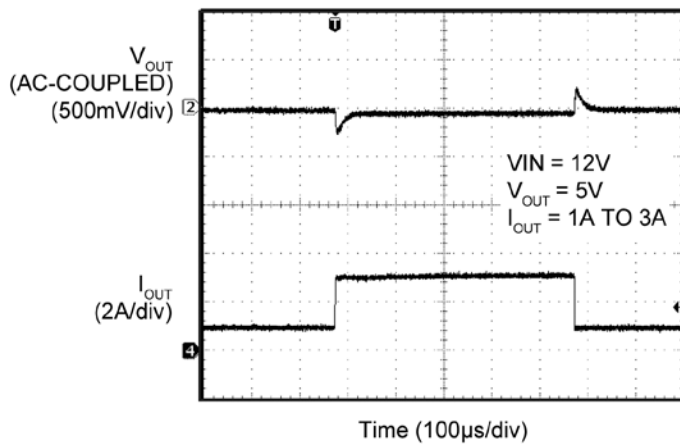

Power Good @ VIN Soft Turn-On

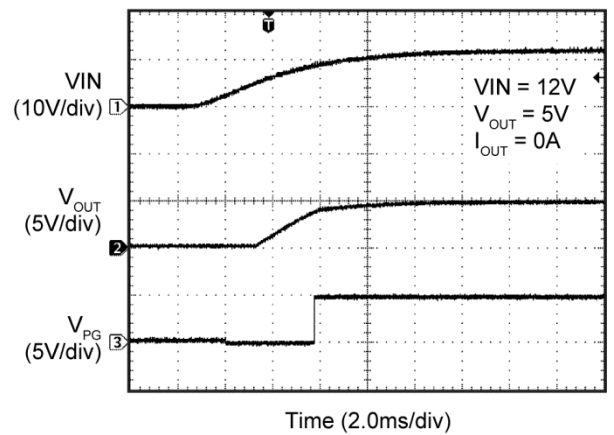

Power Good @ VIN Soft Turn-Off

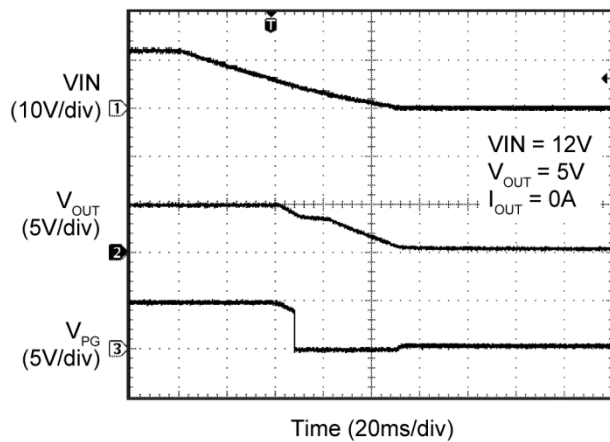

## Functional Characteristics

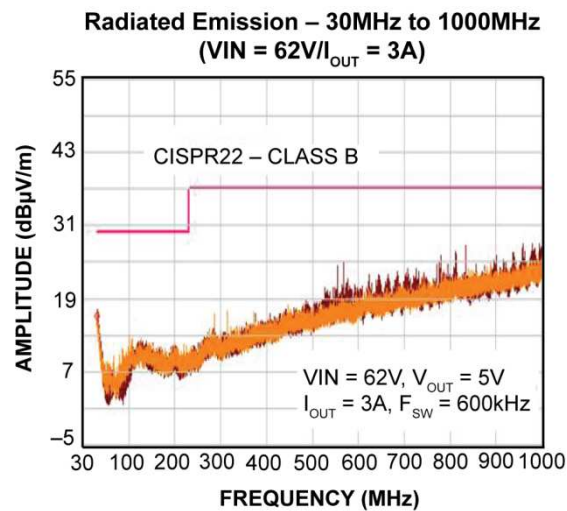
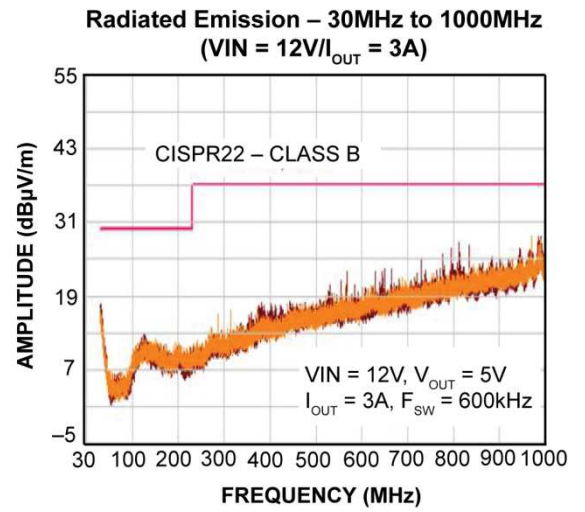
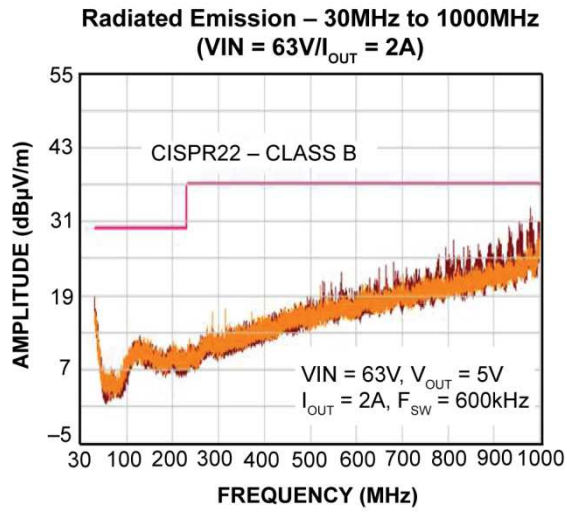
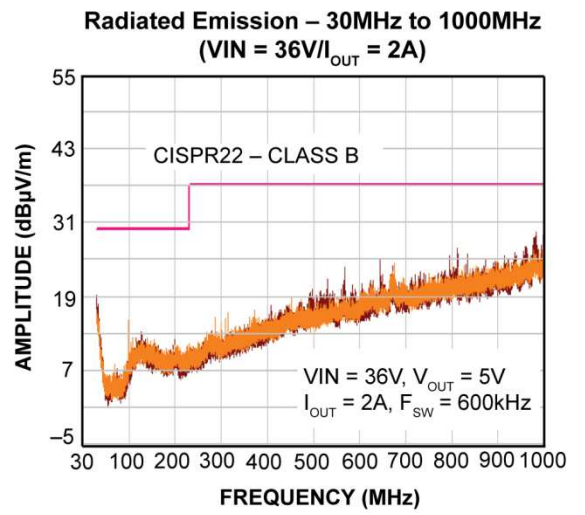
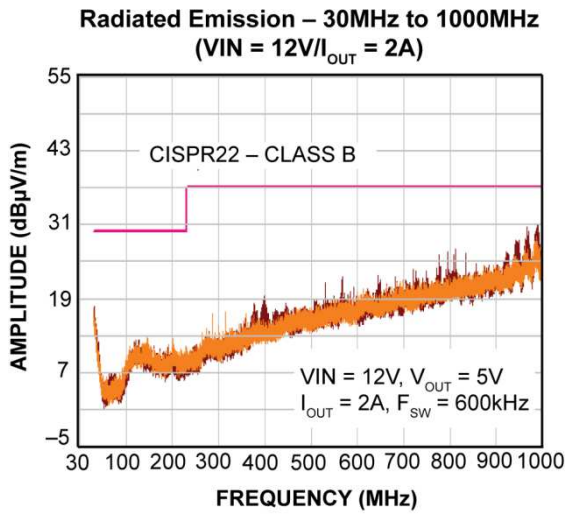

### Functional Diagram

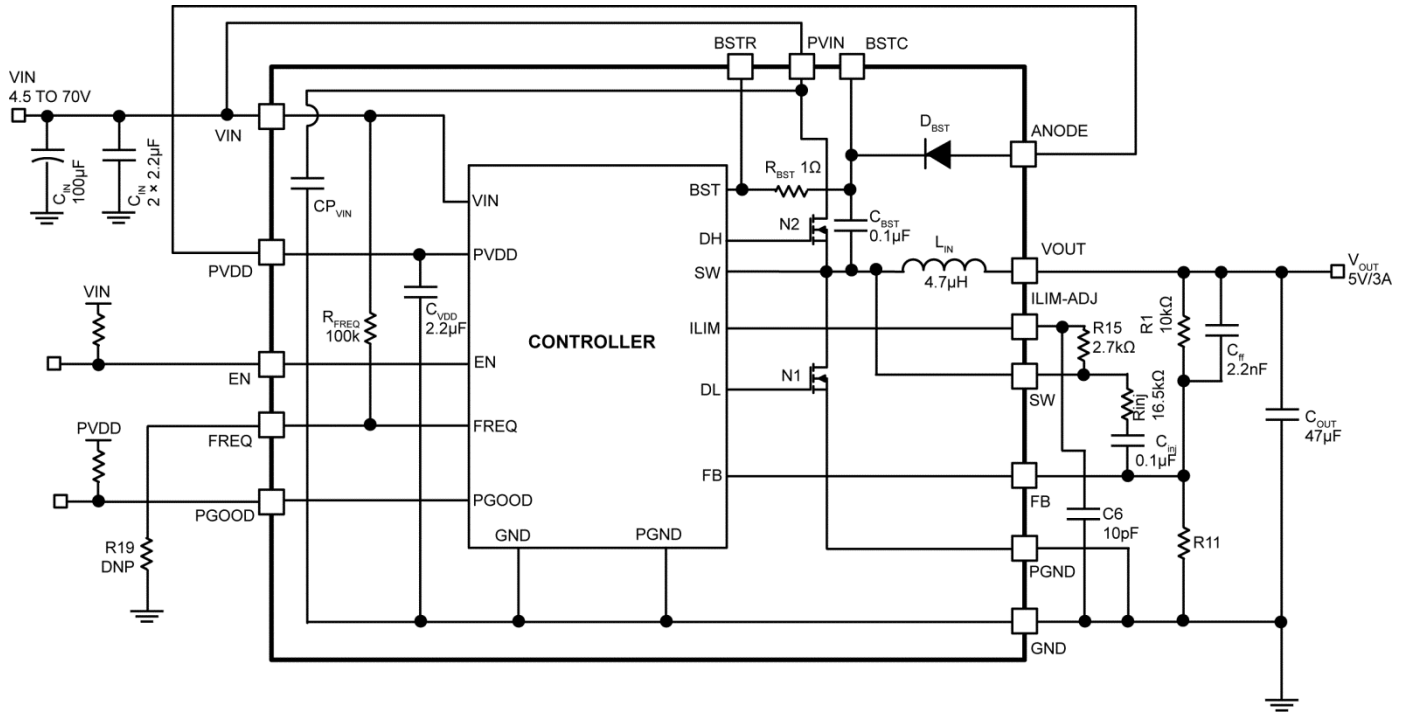

## Functional Description

The MIC28304 is an adaptive on-time synchronous buck regulator module built for high-input voltage to low-output voltage conversion applications. The MIC28304 is designed to operate over a wide input voltage range, from 4.5V to 70V, and the output is adjustable with an external resistor divider. An adaptive on-time control scheme is employed to obtain a constant switching frequency and to simplify the control compensation. Hiccup mode over-current protection is implemented by sensing low-side MOSFET's  $R_{DS(ON)}$ . The device features internal soft-start, enable, UVLO, and thermal shutdown. The module has integrated switching FETs, inductor, bootstrap diode, resistor and capacitor.

### Theory of Operation

Per the *Functional Diagram* of the MIC28304 module, the output voltage is sensed by the MIC28304 feedback pin FB via the voltage divider R1 and R11, and compared to a 0.8V reference voltage VREF at the error comparator through a low-gain transconductance ( $g_m$ ) amplifier. If the feedback voltage decreases and the amplifier output is below 0.8V, then the error comparator will trigger the control logic and generate an ON-time period. The ON-time period length is predetermined by the "Fixed  $t_{ON}$  Estimator" circuitry:

$$t_{ON(ESTIMATED)} = \frac{V_{OUT}}{V_{IN} \times f_{SW}} \quad \text{Eq. 1}$$

where  $V_{OUT}$  is the output voltage,  $V_{IN}$  is the power stage input voltage, and  $f_{SW}$  is the switching frequency.

At the end of the ON-time period, the internal high-side driver turns off the high-side MOSFET and the low-side driver turns on the low-side MOSFET. The OFF-time period length depends upon the feedback voltage in most cases. When the feedback voltage decreases and the output of the  $g_m$  amplifier is below 0.8V, the ON-time period is triggered and the OFF-time period ends. If the OFF-time period determined by the feedback voltage is less than the minimum OFF-time  $t_{OFF(MIN)}$ , which is about 200ns, the MIC28304 control logic will apply the  $t_{OFF(MIN)}$  instead.  $t_{OFF(MIN)}$  is required to maintain enough energy in the boost capacitor ( $C_{BST}$ ) to drive the high-side MOSFET.

The maximum duty cycle is obtained from the 200ns  $t_{OFF(MIN)}$ :

$$D_{MAX} = \frac{t_S - t_{OFF(MIN)}}{t_S} = 1 - \frac{200ns}{t_S} \quad \text{Eq. 2}$$

Where:

$t_S = 1/f_{SW}$ . It is not recommended to use MIC28304 with an OFF-time close to  $t_{OFF(MIN)}$  during steady-state operation.

The adaptive ON-time control scheme results in a constant switching frequency in the MIC28304. The actual ON-time and resulting switching frequency will vary with the different rising and falling times of the external MOSFETs. Also, the minimum  $t_{ON}$  results in a lower switching frequency in high  $V_{IN}$  to  $V_{OUT}$  applications. During load transients, the switching frequency is changed due to the varying OFF-time.

To illustrate the control loop operation, we will analyze both the steady-state and load transient scenarios. For easy analysis, the gain of the  $g_m$  amplifier is assumed to be 1. With this assumption, the inverting input of the error comparator is the same as the feedback voltage.

Figure 1 shows the MIC28304 control loop timing during steady-state operation. During steady-state, the  $g_m$  amplifier senses the feedback voltage ripple, which is proportional to the output voltage ripple plus injected voltage ripple, to trigger the ON-time period. The ON-time is predetermined by the  $t_{ON}$  estimator. The termination of the OFF-time is controlled by the feedback voltage. At the valley of the feedback voltage ripple, which occurs when  $V_{FB}$  falls below  $V_{REF}$ , the OFF period ends and the next ON-time period is triggered through the control logic circuitry.

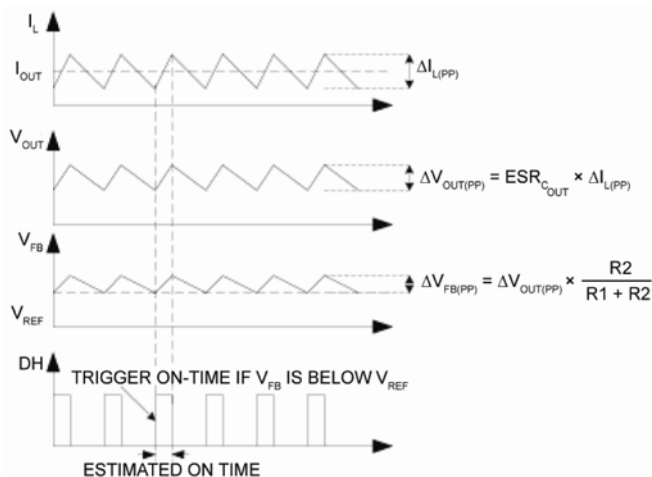

Figure 1. MIC28304 Control Loop Timing

Figure 2 shows the operation of the MIC28304 during a load transient. The output voltage drops due to the sudden load increase, which causes the  $V_{FB}$  to be less than  $V_{REF}$ . This will cause the error comparator to trigger an ON-time period. At the end of the ON-time period, a minimum OFF-time  $t_{OFF(MIN)}$  is generated to charge the bootstrap capacitor ( $C_{BST}$ ) since the feedback voltage is still below  $V_{REF}$ . Then, the next ON-time period is triggered due to the low feedback voltage. Therefore, the switching frequency changes during the load transient, but returns to the nominal fixed frequency once the output has stabilized at the new load current level. With the varying duty cycle and switching frequency, the output recovery time is fast and the output voltage deviation is small.

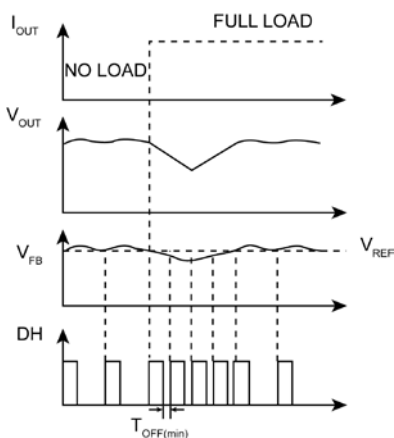

Figure 2. MIC28304 Load Transient Response

Unlike true current-mode control, the MIC28304 uses the output voltage ripple to trigger an ON-time period. The output voltage ripple is proportional to the inductor current ripple if the ESR of the output capacitor is large enough.

In order to meet the stability requirements, the MIC28304 feedback voltage ripple should be in phase with the inductor current ripple and are large enough to be sensed by the  $g_m$  amplifier and the error comparator. The recommended feedback voltage ripple is 20mV~100mV over full input voltage range. If a low ESR output capacitor is selected, then the feedback voltage ripple may be too small to be sensed by the  $g_m$  amplifier and the error comparator. Also, the output voltage ripple and the feedback voltage ripple are not necessarily in phase with the inductor current ripple if the ESR of the output capacitor is very low. In these cases, ripple injection is required to ensure proper operation. Please refer to “Ripple Injection” subsection in [Application Information](#) for more details about the ripple injection technique.

**Discontinuous Mode (MIC28304-1 only)**

In continuous mode, the inductor current is always greater than zero; however, at light loads, the MIC28304-1 is able to force the inductor current to operate in discontinuous mode. Discontinuous mode is where the inductor current falls to zero, as indicated by trace ( $I_L$ ) shown in [Figure 3](#). During this period, the efficiency is optimized by shutting down all the non-essential circuits and minimizing the supply current. The MIC28304-1 wakes up and turns on the high-side MOSFET when the feedback voltage  $V_{FB}$  drops below 0.8V.

The MIC28304-1 has a zero crossing comparator (ZC) that monitors the inductor current by sensing the voltage drop across the low-side MOSFET during its ON-time. If the  $V_{FB} > 0.8V$  and the inductor current goes slightly negative, then the MIC28304-1 automatically powers down most of the IC circuitry and goes into a low-power mode.

Once the MIC28304-1 goes into discontinuous mode, both DL and DH are low, which turns off the high-side and low-side MOSFETs. The load current is supplied by the output capacitors and  $V_{OUT}$  drops. If the drop of  $V_{OUT}$  causes  $V_{FB}$  to go below  $V_{REF}$ , then all the circuits will wake up into normal continuous mode. First, the bias currents of most circuits reduced during the discontinuous mode are restored, and then a  $t_{ON}$  pulse is triggered before the drivers are turned on to avoid any possible glitches. Finally, the high-side driver is turned on. [Figure 3](#) shows the control loop timing in discontinuous mode.



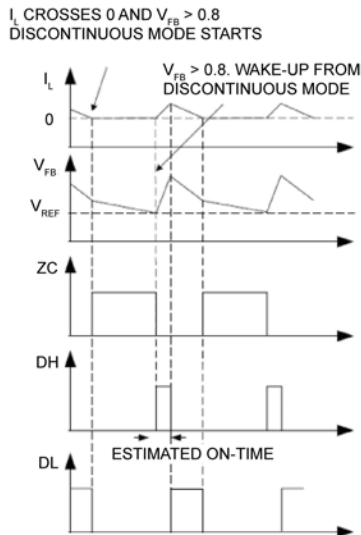

**Figure 3. MIC28302-1 Control Loop Timing (Discontinuous Mode)**

During discontinuous mode, the bias current of most circuits is substantially reduced. As a result, the total power supply current during discontinuous mode is only about 400µA, allowing the MIC28304-1 to achieve high efficiency in light load applications.

**Soft-Start**

Soft-start reduces the input power supply surge current at startup by controlling the output voltage rise time. The input surge appears while the output capacitor is charged up. A slower output rise time will draw a lower input surge current.

The MIC28304 implements an internal digital soft-start by making the 0.8V reference voltage  $V_{REF}$  ramp from 0 to 100% in about 5ms with 9.7mV steps. Therefore, the output voltage is controlled to increase slowly by a staircase  $V_{FB}$  ramp. Once the soft-start cycle ends, the related circuitry is disabled to reduce current consumption. PVDD must be powered up at the same time or after  $V_{IN}$  to make the soft-start function correctly.

**Current Limit**

The MIC28304 uses the  $R_{DS(ON)}$  of the low side MOSEFET and external resistor connected from ILIM pin to SW node to decide the current limit.

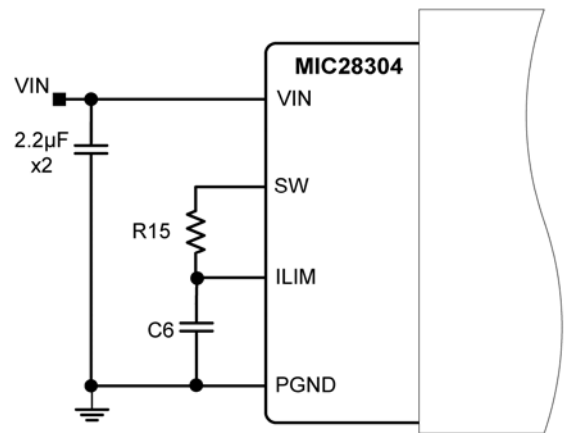

**Figure 4. MIC28304 Current-Limiting Circuit**

In each switching cycle of the MIC28304, the inductor current is sensed by monitoring the low-side MOSFET in the OFF period. The sensed voltage  $V(ILIM)$  is compared with the power ground (PGND) after a blanking time of 150ns. In this way the drop voltage over the resistor R15 ( $V_{CL}$ ) is compared with the drop over the bottom FET generating the short current limit. The small capacitor (C6) connected from ILIM pin to PGND filters the switching node ringing during the off-time allowing a better short limit measurement. The time constant created by R15 and C6 should be much less than the minimum off time.

The  $V_{CL}$  drop allows programming of short limit through the value of the resistor (R15), If the absolute value of the voltage drop on the bottom FET is greater than  $V_{CL}$ . In that case the  $V(ILIM)$  is lower than PGND and a short circuit event is triggered. A hiccup cycle to treat the short event is generated. The hiccup sequence including the soft start reduces the stress on the switching FETs and protects the load and supply for severe short conditions.

The short-circuit current limit can be programmed by using Equation 3.

$$R15 = \frac{(I_{CLIM} - \Delta I_{L(PP)} \times 0.5) \times R_{DS(ON)} + V_{CL}}{I_{CL}} \quad \text{Eq. 3}$$

Where:

$I_{CLIM}$  = Desired current limit

$R_{DS(ON)}$  = On-resistance of low-side power MOSFET, 57m $\Omega$  typically

$V_{CL}$  = Current-limit threshold (typical absolute value is 14mV per the [Electrical Characteristics](#)<sup>(4)</sup>)

$I_{CL}$  = Current-limit source current (typical value is 80 $\mu$ A, per the Electrical Characteristics table).

$\Delta I_{L(PP)}$  = Inductor current peak-to-peak, since the inductor is integrated use Equation 4 to calculate the inductor ripple current.

The peak-to-peak inductor current ripple is:

$$\Delta I_{L(PP)} = \frac{V_{OUT} \times (V_{IN(max)} - V_{OUT})}{V_{IN(max)} \times f_{sw} \times L} \quad \text{Eq. 4}$$

The MIC28304 has 4.7 $\mu$ H inductor integrated into the module. The typical value of  $R_{WINDING(DCR)}$  of this particular inductor is in the range of 45m $\Omega$ .

In case of hard short, the short limit is folded down to allow an indefinite hard short on the output without any destructive effect. It is mandatory to make sure that the inductor current used to charge the output capacitance during soft start is under the folded short limit; otherwise the supply will go in hiccup mode and may not be finishing the soft start successfully.

The MOSFET  $R_{DS(ON)}$  varies 30% to 40% with temperature; therefore, it is recommended to add a 50% margin to  $I_{CLIM}$  in Equation 3 to avoid false current limiting due to increased MOSFET junction temperature rise. [Table 2](#) shows typical output current limit value for a given R15 with C6 = 10pF.

**Table 2. Typical Output Current-Limit Value**

R15	Typical Output Current Limit
1.81k $\Omega$	3A
2.7k $\Omega$	6.3A