



Chipsmall Limited consists of a professional team with an average of over 10 year of expertise in the distribution of electronic components. Based in Hongkong, we have already established firm and mutual-benefit business relationships with customers from,Europe,America and south Asia,supplying obsolete and hard-to-find components to meet their specific needs.

With the principle of “Quality Parts,Customers Priority,Honest Operation,and Considerate Service”,our business mainly focus on the distribution of electronic components. Line cards we deal with include Microchip,ALPS,ROHM,Xilinx,Pulse,ON,Everlight and Freescale. Main products comprise IC,Modules,Potentiometer,IC Socket,Relay,Connector.Our parts cover such applications as commercial,industrial, and automotives areas.

We are looking forward to setting up business relationship with you and hope to provide you with the best service and solution. Let us make a better world for our industry!



## Contact us

Tel: +86-755-8981 8866 Fax: +86-755-8427 6832

Email & Skype: info@chipsmall.com Web: www.chipsmall.com

Address: A1208, Overseas Decoration Building, #122 Zhenhua RD., Futian, Shenzhen, China





# MIC28500 4A Evaluation Board

## 75V/4A Hyper Speed Control™ Synchronous DC/DC Buck Regulator

### General Description

The MIC28500 DC/DC regulator operates over an input supply range of 30V to 75V and provides a regulated output at up to 4A of output current. The output voltage is adjustable down to 0.8V with a typical accuracy of  $\pm 1\%$ . The switching frequency is adjustable and once adjusted the switching frequency remains fairly constant with changes in input voltage and output load.

The basic parameters of the evaluation board are:

1. Input – 30V to 75V
2. Output – 0.8V to 5V at 4A <sup>(1)</sup>, 12V at 2A <sup>(2)</sup>
3. 250kHz Switching Frequency (Adjustable 100kHz to 500kHz)

#### Notes:

1,2. Refer to thermal de-rating curves shown in Typical Characteristics section.

Datasheets and support documentation can be found on Micrel's web site at: [www.micrel.com](http://www.micrel.com).

### Requirements

The MIC28500 evaluation board requires only a single power supply with at least 10A current capability. A linear regulator, which includes a Zener and an NPN transistor, has been installed on the board to provide housekeeping ( $V_{DD}$ ) for the MIC28500. The output load can either be a passive or an active load.

### Precautions

The MIC28500 evaluation board does not have reverse polarity protection. Applying a negative voltage to the PVIN and GND terminals may damage the device. The maximum PVIN of the board is rated at 75V. Exceeding 75V on the PVIN could damage the device.

### Getting Started

#### 1. $V_{IN}$ Supply

Connect a supply to the Vin and GND terminals, paying careful attention to the polarity and the supply range ( $30V < V_{IN} < 75V$ ). Monitor  $I_{IN}$  with a current

meter and  $V_{IN}$  at Vin and GND terminals with voltmeter. Do not apply power until Step 5.

#### 2. Connect Load and Monitor Output

Connect a load to the Vout and GND terminals. The load can be either a passive (resistive) or an active (as in an electronic load) type. A current meter may be placed between the Vout terminal and load to monitor the output current. Ensure the output voltage is monitored at the Vout terminal.

#### 3. $V_{IN}$ 30V Limiter Circuit

To prevent overstressing of the internal top FET of the MIC28500, the minimum input voltage at full load should be limited to 30V. This is implemented by using external VIN limiter circuit installed on either EN pin (dash-line block#1) or VDD Pin (dash-line block#2) as shown in the Evaluation board schematic. On the MIC28500 evaluation board the limiter circuit on EN Pin is installed, which shuts off the MIC28500 until the input supply voltage reaches 30V.

#### 4. Enable Input

The EN pin has an internal 100k pull-up resistor to VDD, which allows the output to be turned on when VDD exceeds its UVLO threshold. An EN connector is provided on the evaluation board for users to easily access the enable feature. Applying an external logic signal on the EN pin to pull it low or using a jumper to short the EN pin to GND will shut off the output of the MIC28500 evaluation board. If in certain application the EN needs to be controlled externally the  $V_{IN}$  limiter circuit should be implemented on VDD pin.

#### 5. Turn on the Power

Turn on the VIN supply and verify that the output voltage is regulated to 3.3V.

### Ordering Information

Part Number	Description
MIC28500 4A EV	Evaluation Board up to 5V Output
MIC28500 2A EV	Evaluation Board 12V Output

Hyper Speed Control is a trademark of Micrel, Inc

Micrel Inc. • 2180 Fortune Drive • San Jose, CA 95131 • USA • tel +1 (408) 944-0800 • fax + 1 (408) 474-1000 • <http://www.micrel.com>



## Features

### Feedback Resistors

The output voltage on the MIC28500 evaluation board, which is preset to 3.3V, is determined by the feedback divider:

$$V_{OUT} = V_{REF} \times \left( 1 + \frac{R4}{R_{BOTTOM}} \right)$$

where  $V_{REF} = 0.8V$ , and  $R_{BOTTOM}$  is one of R5, R6, R7, R8, R9, R10, R11, R12, which corresponds to 0.9V, 1.0V, 1.2V, 1.5V, 1.8V, 2.5V, 3.3V, or 5V. Leaving the  $R_{BOTTOM}$  open gives a 0.8V output voltage. All other voltages not listed above can be set by modifying  $R_{BOTTOM}$  value according to:

$$R_{BOTTOM} = \frac{R4 \times V_{REF}}{V_{OUT} - V_{REF}}$$

Note that the output voltage should not be set to exceed 5V due to the 6.3V voltage rating on the output capacitors.

If higher than 5V output is desired, it is recommended to use the designs shown in Figure 2, where the output capacitors, L1, R3 and R17 are optimized for 12V/2A output.

### SW Node

Test point J11 (VSW) is placed for monitoring the switching waveform, one of the most critical waveforms for the converter.

### Current Limit

The MIC28500 has internal FETs, and the current limit is implemented by sensing the  $R_{DS-ON}$  of bottom FET. The MIC28500 has a fixed current limit of 7A (TYP).

### Loop Gain Measurement

The resistor, R13, is placed in series with the regulator feedback path. The control loop gain can be measured by connecting an impedance analyzer across the resistor and selecting the resistor value in between 20Ω to 50Ω.

### MIC28500 0.8V to 5V/4A Evaluation Board Typical Characteristics

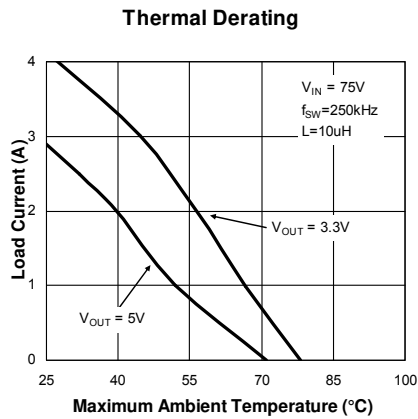
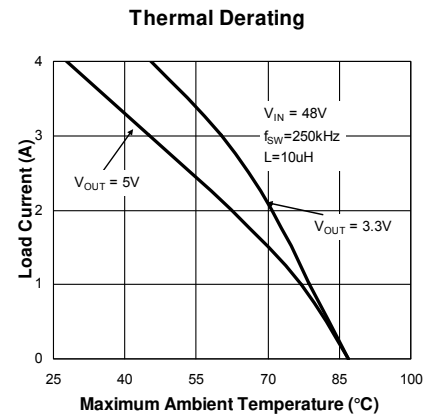
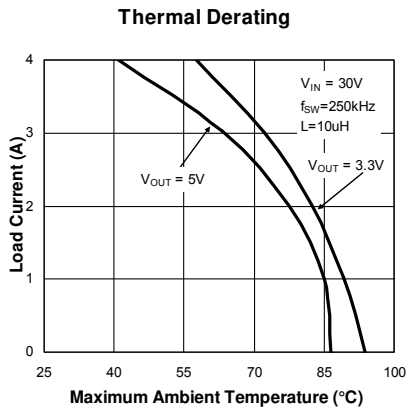
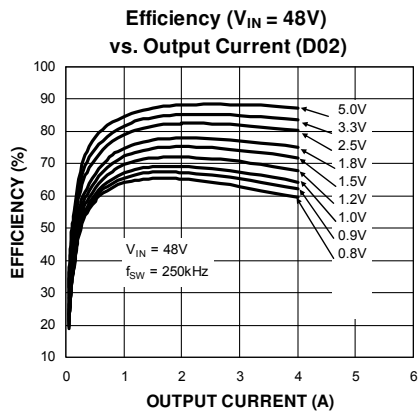

**Die Temperature\*** : The temperature measurement was taken at the hottest point on the MIC28500 case mounted on a 5 square inch 4 layer, 0.62", FR-4 PCB with 2oz. finish copper weight per layer, see Thermal Measurement section. Actual results will depend upon the size of the PCB, ambient temperature and proximity to other heat emitting components.

### MIC28500 0.8V to 5V/4A Output Evaluation Board Schematic

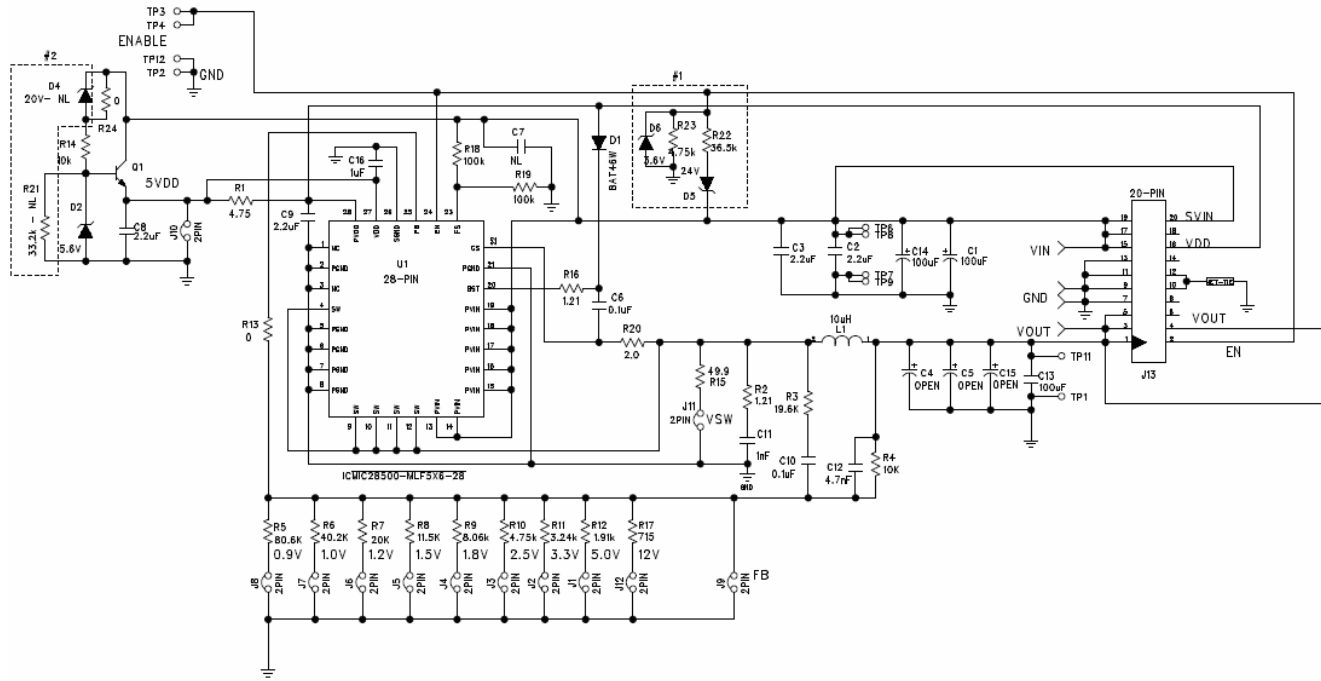

Figure 1. MIC28500 Evaluation board for 0.8V to 5V/4A Output

**Bill of Materials 0.8V to 5V/4A Output**

Item	Part Number	Manufacturer	Description	Qty.
C1	EEU-FC2A101B	Panasonic <sup>(1)</sup>	100µF Aluminum Capacitor, SMD, 100V	1
C2, C3	GRM32ER72A225KA35L	Murata <sup>(2)</sup>	2.2µF Ceramic Capacitor, X7R, Size 1210, 100V	2
	C3225X7R2A225KT5	TDK <sup>(3)</sup>		
C13	GRM32ER60J107ME20L	Murata	100µF Ceramic Capacitor, X5R, Size 1210, 6.3V	1
	12106D107MAT2A	AVX <sup>(4)</sup>		
C6	06035C104KAT2A	AVX <sup>(4)</sup>	0.1µF Ceramic Capacitor, X7R, Size 0603, 50V	1
	GRM188R71H104KA93D	Murata <sup>(2)</sup>		
	C1608X7R1H104K	TDK <sup>(3)</sup>		
C10	GRM188R72A104KA35D	Murata	0.1µF Ceramic Capacitor, X7R, Size 0603, 100V	1
	C1608X7S2A104K	TDK <sup>(3)</sup>		
C8, C9	0805ZC225MAT2A	AVX <sup>(4)</sup>	2.2µF Ceramic Capacitor, X7R, Size 0805, 10V	2
	GRM21BR71A225KA01L	Murata <sup>(2)</sup>		
	C2012X7R1A225K	TDK <sup>(3)</sup>		
C11	GRM188R72A102KA01D	Murata <sup>(2)</sup>	1nF Ceramic Capacitor, X7R, Size 0603, 100V	1
	C1608X7R2A102K	TDK <sup>(3)</sup>		
	06031C102KAT2A	AVX <sup>(4)</sup>		
C12	GRM188R71H472KA01D	Murata <sup>(2)</sup>	4.7nF Ceramic Capacitor, X7R, Size 0603, 50V	1
	C1608X7R2A472K	TDK <sup>(3)</sup>		
	06035C472KAT2A	AVX <sup>(4)</sup>		
C16	GRM21BR71A105KA01L	Murata <sup>(2)</sup>	1µF Ceramic Capacitor, X7R, Size 0805, 10V	1
	C2012X7R1A105K	TDK <sup>(3)</sup>		
C4, C5, C7	Open			
C14, C15	Open			
D1	BAT46W-TP	MCC <sup>(5)</sup>	Small Signal Schottky Diode	1
	BAT46W-7-F	Diodes Inc. <sup>(6)</sup>		
D2	MMXZ5232B-TP	MCC <sup>(5)</sup>	5.6V Zener Diode	1
	CMDZ5L6	Central Semi <sup>(7)</sup>		
D5	CMDZ24L-MIC	Central Semi <sup>(7)</sup>	24V Zener Diode	1
D6	CMDZ3L6-MIC	Central Semi <sup>(7)</sup>	3.6V Zener Diode	1
D4	Open			
L1	DR125-100-R	Cooper Bussmann <sup>(8)</sup>	10µH Inductor, 5.35A RMS, 7A Saturation Current	1
Q1	FCX493	Diodes Inc/ZETEX <sup>(6)</sup>	100V NPN Transistor	1
R1	CRCW06034R75FKEA	Vishay Dale <sup>(9)</sup>	4.75Ω Resistor, Size 0603, 1%	1
R2, R16	CRCW08051R21FKEA	Vishay Dale <sup>(9)</sup>	1.21Ω Resistor, Size 0805, 1%	2
R3	CRCW060319K6FKEA	Vishay Dale <sup>(9)</sup>	19.6kΩ Resistor, Size 0603, 1%	1
R4	CRCW060310K0FKEA	Vishay Dale <sup>(9)</sup>	10kΩ Resistor, Size 0603, 1%	1
R5	CRCW060380K6FKEA	Vishay Dale <sup>(9)</sup>	80.6kΩ Resistor, Size 0603, 1%	1

**Bill of Materials 0.8V to 5V/4A Output (Continued)**

R6	CRCW060340K2FKEA	Vishay Dale <sup>(9)</sup>	40.2kΩ Resistor, Size 0603, 1%	1
R7	CRCW060320K0FKEA	Vishay Dale <sup>(9)</sup>	20kΩ Resistor, Size 0603, 1%	1
R8	CRCW060311K5FKEA	Vishay Dale <sup>(9)</sup>	11.5kΩ Resistor, Size 0603, 1%	1
R9	CRCW06038K06FKEA	Vishay Dale <sup>(9)</sup>	8.06kΩ Resistor, Size 0603, 1%	1
R10, R23	CRCW06034K75FKEA	Vishay Dale <sup>(9)</sup>	4.75kΩ Resistor, Size 0603, 1%	2
R11	CRCW06033K24FKEA	Vishay Dale <sup>(9)</sup>	3.24kΩ Resistor, Size 0603, 1%	1
R12	CRCW06031K91FKEA	Vishay Dale <sup>(9)</sup>	1.91kΩ Resistor, Size 0603, 1%	1
R13, R24	CRCW06030000Z0EAHP	Vishay Dale <sup>(9)</sup>	0Ω Resistor, Size 0603	2
R14	CRCW080510K0JNEA	Vishay Dale <sup>(9)</sup>	10kΩ Resistor, Size 0805, 1%	1
R15	CRCW060349R9FKEA	Vishay Dale <sup>(9)</sup>	49.9Ω Resistor, Size 0603, 1%	1
R17 (OPEN)	CRCW0603715RFKEA	Vishay Dale <sup>(9)</sup>	715Ω Resistor, Size 0603, 1%	
R18, R19	CRCW0603100KFKEAHP	Vishay Dale <sup>(9)</sup>	100kΩ Resistor, Size 0603, 1%	2
R20	CRCW06032R00FKEA	Vishay Dale <sup>(9)</sup>	2Ω Resistor, Size 0603, 1%	1
R21 (OPEN)	CRCW060333K2FKEA	Vishay Dale <sup>(9)</sup>	33.2kΩ Resistor, Size 0603, 1%	
R22	CRCW060336K5FKEA	Vishay Dale <sup>(9)</sup>	36.5kΩ Resistor, Size 0603, 1%	1
<b>U1</b>	<b>MIC28500YJL</b>	<b>Micrel, Inc.<sup>(10)</sup></b>	<b>75V/4A Synchronous Buck DC-DC Regulator</b>	<b>1</b>

**Notes:**

1. Panasonic: [www.panasonic.com](http://www.panasonic.com).
2. Murata: [www.murata.com](http://www.murata.com).
3. TDK: [www.tdk.com](http://www.tdk.com).
4. AVX: [www.avx.com](http://www.avx.com).
5. MCC: [www.mccsemi.com](http://www.mccsemi.com).
6. Diode Inc.: [www.diodes.com](http://www.diodes.com).
7. Central Semi: [www.centalsemi.com](http://www.centalsemi.com).
8. Cooper: [www.cooperbussman.com](http://www.cooperbussman.com).
9. Vishay: [www.vishay.com](http://www.vishay.com)
10. Micrel, Inc.: [www.micrel.com](http://www.micrel.com).

## MIC28500 12V/2A Output Evaluation Board Typical Characteristics

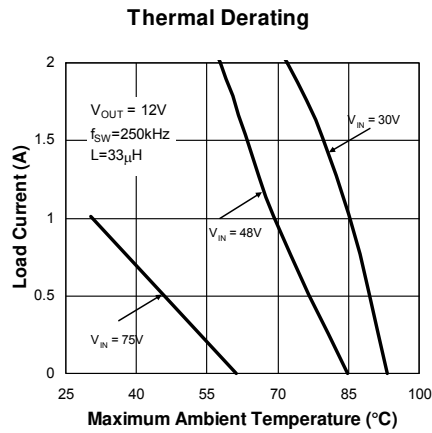
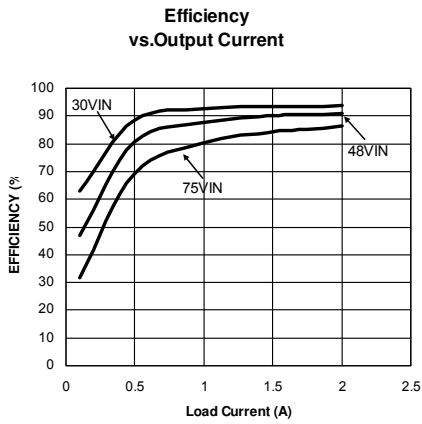

**Die Temperature\*** : The temperature measurement was taken at the hottest point on the MIC28500 case mounted on a 5 square inch 4 layer, 0.62", FR-4 PCB with 2oz. finish copper weight per layer, see Thermal Measurement section. Actual results will depend upon the size of the PCB, ambient temperature and proximity to other heat emitting components.



# MIC28500 12V/2A Output Evaluation Board Schematic

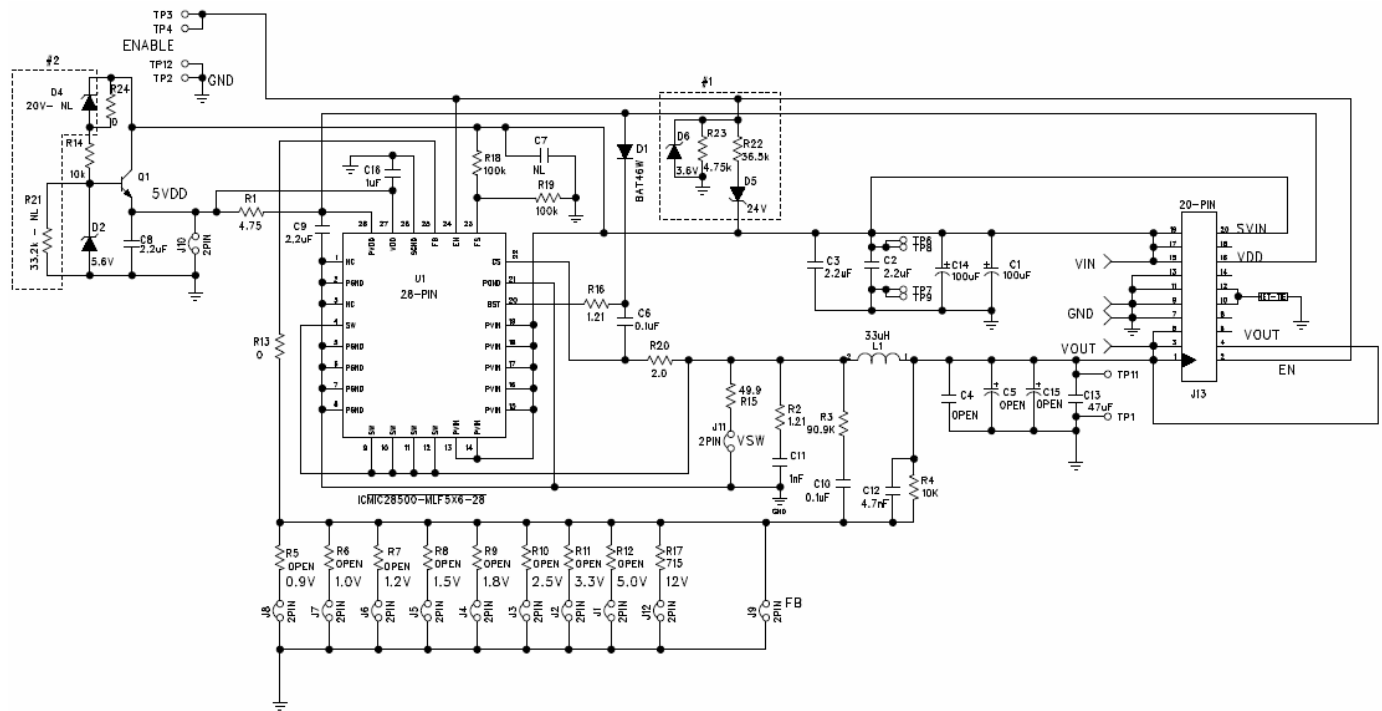

Figure 2. MIC28500 Evaluation board for 12V/2A Output

**Bill of Materials 12V/2A Output**

Item	Part Number	Manufacturer	Description	Qty.
C1	EEU-FC2A101B	Panasonic <sup>(1)</sup>	100µF Aluminum Capacitor, SMD, 100V	1
C2, C3	GRM32ER72A225KA35L	Murata <sup>(2)</sup>	2.2µF Ceramic Capacitor, X7R, Size 1210, 100V	2
	C3225X7R2A225KT5	TDK <sup>(3)</sup>		
C13	GRM32ER61C476ME15	Murata <sup>(2)</sup>	47µF/16V Ceramic Capacitor, X5R, Size 1210	1
	EMK325BJ476MM-T	Taiyo Yuden <sup>(4)</sup>		
C6	06035C104KAT2A	AVX <sup>(5)</sup>	0.1µF Ceramic Capacitor, X7R, Size 0603, 50V	1
	GRM188R71H104KA93D	Murata <sup>(2)</sup>		
	C1608X7R1H104K	TDK <sup>(3)</sup>		
C10	GRM188R72A104KA35D	Murata <sup>(2)</sup>	0.1µF Ceramic Capacitor, X7R, Size 0603, 100V	1
	C1608X7S2A104K	TDK <sup>(3)</sup>		
C8, C9	0805ZC225MAT2A	AVX <sup>(5)</sup>	2.2µF Ceramic Capacitor, X7R, Size 0805, 10V	2
	GRM21BR71A225KA01L	Murata <sup>(2)</sup>		
	C2012X7R1A225K	TDK <sup>(3)</sup>		
C11	GRM188R72A102KA01D	Murata <sup>(2)</sup>	1nF Ceramic Capacitor, X7R, Size 0603, 100V	1
	C1608X7R2A102K	TDK <sup>(3)</sup>		
	06031C102KAT2A	AVX <sup>(5)</sup>		
C12	GRM188R71H472KA01D	Murata <sup>(2)</sup>	4.7nF Ceramic Capacitor, X7R, Size 0603, 50V	1
	C1608X7R2A472K	TDK <sup>(3)</sup>		
	06035C472KAT2A	AVX <sup>(5)</sup>		
C16	GRM21BR71A105KA01L	Murata <sup>(2)</sup>	1µF Ceramic Capacitor, X7R, Size 0805, 10V	1
	C2012X7R1A105K	TDK <sup>(3)</sup>		
C4, C5, C7	Open			
C14, C15	Open			
D1	BAT46W-TP	MCC <sup>(6)</sup>	Small Signal Schottky Diode	1
	BAT46W-7-F	Diodes Inc. <sup>(7)</sup>		
D2	MMXZ5232B-TP	MCC <sup>(6)</sup>	5.6V Zener Diode	1
	CMDZ5L6	Central Semi <sup>(8)</sup>		
D5	CMDZ24L-MIC	Central Semi <sup>(8)</sup>	24V Zener Diode	1
D6	CMDZ3L6-MIC	Central Semi <sup>(8)</sup>	3.6V Zener Diode	1
D4	Open			
L1	DR125-330-R	Cooper Bussmann <sup>(9)</sup>	33µH Inductor, 3.28A RMS, 3.84A Saturation Current	1
Q1	FCX493	Diodes Inc/ZETEX <sup>(7)</sup>	100V NPN Transistor	1
R1	CRCW06034R75FKEA	Vishay Dale <sup>(10)</sup>	4.75Ω Resistor, Size 0603, 1%	1
R2, R16	CRCW08051R21FKEA	Vishay Dale <sup>(10)</sup>	1.21Ω Resistor, Size 0805, 1%	2
R3	CRCW060319K6FKEA	Vishay Dale <sup>(10)</sup>	90.9kΩ Resistor, Size 0603, 1%	1
R4	CRCW060310K0FKEA	Vishay Dale <sup>(10)</sup>	10kΩ Resistor, Size 0603, 1%	1

**Bill of Materials 12V/2A Output (Continued)**

Item	Part Number	Manufacturer	Description	Qty.
R5 (Open)	CRCW060380K6FKEA	Vishay Dale <sup>(10)</sup>	80.6kΩ Resistor, Size 0603, 1%	
R6 (Open)	CRCW060340K2FKEA	Vishay Dale <sup>(10)</sup>	40.2kΩ Resistor, Size 0603, 1%	
R7 (Open)	CRCW060320K0FKEA	Vishay Dale <sup>(10)</sup>	20kΩ Resistor, Size 0603, 1%	
R8 (Open)	CRCW060311K5FKEA	Vishay Dale <sup>(10)</sup>	11.5kΩ Resistor, Size 0603, 1%	
R9 (Open)	CRCW06038K06FKEA	Vishay Dale <sup>(10)</sup>	8.06kΩ Resistor, Size 0603, 1%	
R10 (Open)	CRCW06034K75FKEA	Vishay Dale <sup>(10)</sup>	4.75kΩ Resistor, Size 0603, 1%	
R23	CRCW06034K75FKEA	Vishay Dale <sup>(10)</sup>	4.75kΩ Resistor, Size 0603, 1%	1
R11 (Open)	CRCW06033K24FKEA	Vishay Dale <sup>(10)</sup>	3.24kΩ Resistor, Size 0603, 1%	
R12 (Open)	CRCW06031K91FKEA	Vishay Dale <sup>(10)</sup>	1.91kΩ Resistor, Size 0603, 1%	
R13, R24	CRCW06030000Z0EAHP	Vishay Dale <sup>(10)</sup>	0Ω Resistor, Size 0603	2
R14	CRCW080510K0JNEA	Vishay Dale <sup>(10)</sup>	10kΩ Resistor, Size 0805, 1%	1
R15	CRCW060349R9FKEA	Vishay Dale <sup>(10)</sup>	49.9Ω Resistor, Size 0603, 1%	1
R17	CRCW0603715RFKEA	Vishay Dale <sup>(10)</sup>	715Ω Resistor, Size 0603, 1%	1
R18, R19	CRCW0603100KFKEAHP	Vishay Dale <sup>(10)</sup>	100kΩ Resistor, Size 0603, 1%	2
R20	CRCW06032R00FKEA	Vishay Dale <sup>(10)</sup>	2Ω Resistor, Size 0603, 1%	1
R21 (OPEN)	CRCW060333K2FKEA	Vishay Dale <sup>(10)</sup>	33.2kΩ Resistor, Size 0603, 1%	
R22	CRCW060336K5FKEA	Vishay Dale <sup>(10)</sup>	36.5kΩ Resistor, Size 0603, 1%	1
R23	CRCW06034K75FKEA	Vishay Dale <sup>(10)</sup>	4.75kΩ Resistor, Size 0603, 1%	1
<b>U1</b>	<b>MIC28500YJL</b>	<b>Micrel, Inc.</b> <sup>(11)</sup>	<b>75V/4A Synchronous Buck DC-DC Regulator</b>	<b>1</b>

**Notes:**

1. Panasonic: [www.panasonic.com](http://www.panasonic.com).
2. Murata: [www.murata.com](http://www.murata.com).
3. TDK: [www.tdk.com](http://www.tdk.com).
4. Taiyo Yuden: [www.t-yuden.com](http://www.t-yuden.com).
5. AVX: [www.avx.com](http://www.avx.com).
6. MCC: [www.mccsemi.com](http://www.mccsemi.com).
7. Diodes Inc.: [www.diodes.com](http://www.diodes.com).
8. Central Semi: [www.centrialsemi.com](http://www.centrialsemi.com).
9. Cooper: [www.cooperindustries.com](http://www.cooperindustries.com).
10. Vishay: [www.vishay.com](http://www.vishay.com).
11. **Micrel, Inc.:** [www.micrel.com](http://www.micrel.com).

# Evaluation Board PCB Layout

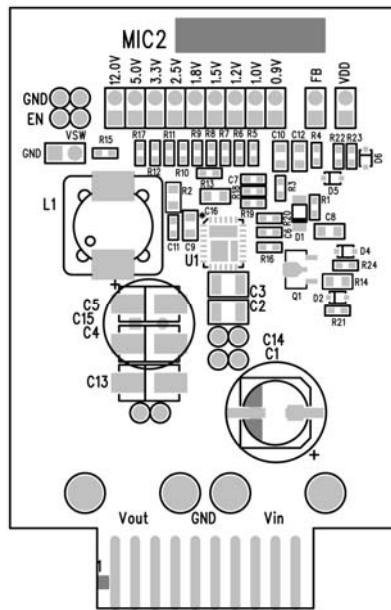

MIC28500 Evaluation Board – Silkscreen Top

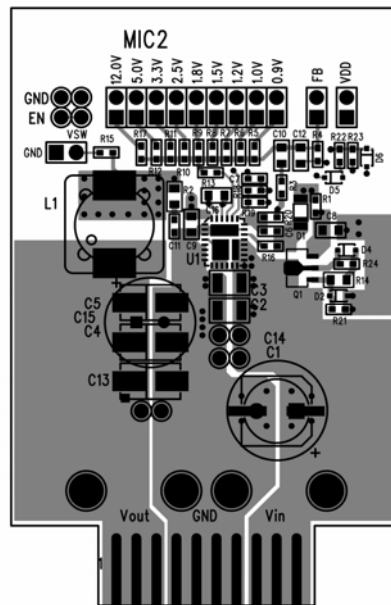

MIC28500 Evaluation Board – Copper Layer 1 (Top)

### Evaluation Board PCB Layout (Continued)

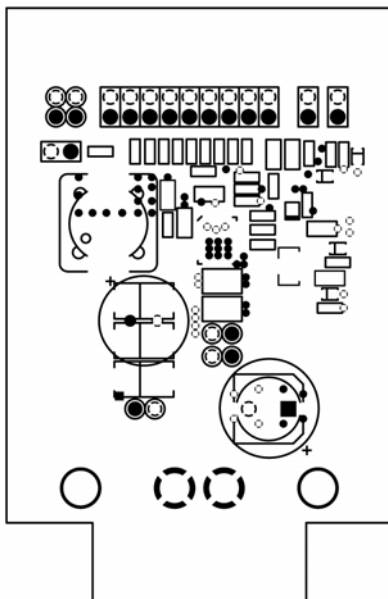

MIC28500 Evaluation Board – Copper Layer 2

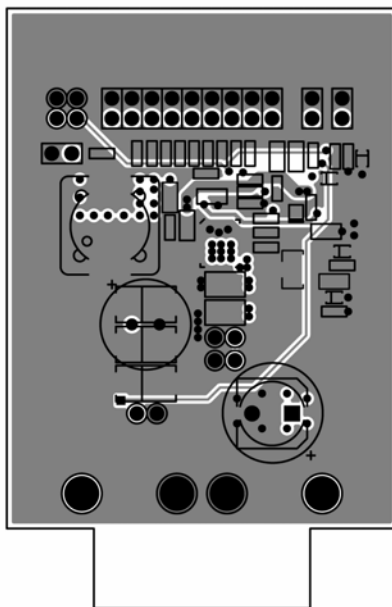

MIC28500 Evaluation Board – Copper Layer 3



### Evaluation Board PCB Layout (Continued)

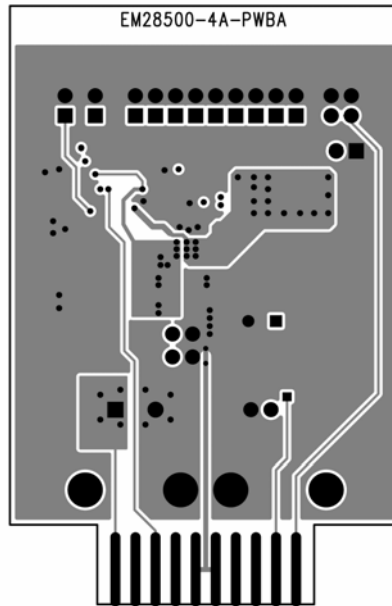

MIC28500 Evaluation Board – Copper Layer 4

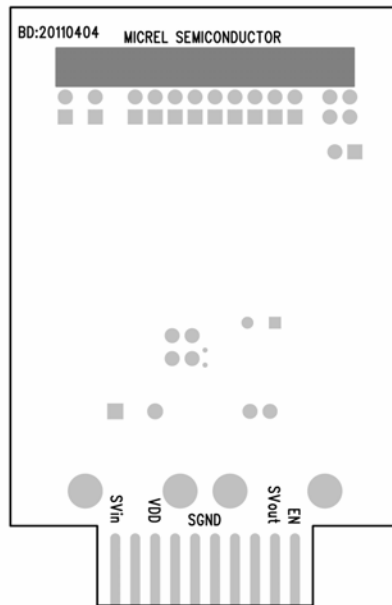

MIC28500 Evaluation Board – Silkscreen Bottom

---

**MICREL, INC. 2180 FORTUNE DRIVE SAN JOSE, CA 95131 USA**TEL +1 (408) 944-0800 FAX +1 (408) 474-1000 WEB <http://www.micrel.com>

Micrel makes no representations or warranties with respect to the accuracy or completeness of the information furnished in this data sheet. This information is not intended as a warranty and Micrel does not assume responsibility for its use. Micrel reserves the right to change circuitry, specifications and descriptions at any time without notice. No license, whether express, implied, arising by estoppel or otherwise, to any intellectual property rights is granted by this document. Except as provided in Micrel's terms and conditions of sale for such products, Micrel assumes no liability whatsoever, and Micrel disclaims any express or implied warranty relating to the sale and/or use of Micrel products including liability or warranties relating to fitness for a particular purpose, merchantability, or infringement of any patent, copyright or other intellectual property right.

Micrel Products are not designed or authorized for use as components in life support appliances, devices or systems where malfunction of a product can reasonably be expected to result in personal injury. Life support devices or systems are devices or systems that (a) are intended for surgical implant into the body or (b) support or sustain life, and whose failure to perform can be reasonably expected to result in a significant injury to the user. A Purchaser's use or sale of Micrel Products for use in life support appliances, devices or systems is a Purchaser's own risk and Purchaser agrees to fully indemnify Micrel for any damages resulting from such use or sale.

© 2011 Micrel, Incorporated.