



Chipsmall Limited consists of a professional team with an average of over 10 year of expertise in the distribution of electronic components. Based in Hongkong, we have already established firm and mutual-benefit business relationships with customers from,Europe,America and south Asia,supplying obsolete and hard-to-find components to meet their specific needs.

With the principle of "Quality Parts,Customers Priority,Honest Operation,and Considerate Service",our business mainly focus on the distribution of electronic components. Line cards we deal with include Microchip,ALPS,ROHM,Xilinx,Pulse,ON,Everlight and Freescale. Main products comprise IC,Modules,Potentiometer,IC Socket,Relay,Connector.Our parts cover such applications as commercial,industrial, and automotives areas.

We are looking forward to setting up business relationship with you and hope to provide you with the best service and solution. Let us make a better world for our industry!



Contact us

Tel: +86-755-8981 8866 Fax: +86-755-8427 6832

Email & Skype: info@chipsmall.com Web: www.chipsmall.com

Address: A1208, Overseas Decoration Building, #122 Zhenhua RD., Futian, Shenzhen, China



2 MHz Synchronous Low Voltage Step-Up Regulator with 6.5A Switch and Bidirectional Load Disconnect

Features

- Typical 6.5A Input Peak Current Limit
- Up to 95% Efficiency
- Fully Integrated, High-Efficiency, 2 MHz Switching Frequency
- Bidirectional True Load Disconnect, Overvoltage Protection (OVP) and Undervoltage Lockout (UVLO)
- Controlled Pre-Charge Current Limit at Start-Up
- Ultra-Fast Transient Response
- Input Voltage Range from 2.5V to 5.5V
- Maximum Output Current:
 - 1.5A, $V_{IN} = 2.5V$ and $V_{OUT} = 5V$
 - 2A, $V_{IN} = 3V$ and $V_{OUT} = 5V$
- Output Voltage Range:
 - Adjustable
 - Fixed Versions: 4.75V, 5V, 5.25V, 5.5V
- Integrated Anti-Ringing Switch for Electromagnetic Interference (EMI) Reduction
- Typically Less than 2 μA Shutdown Current
- Internal Compensation
- Bypass Mode for $V_{IN} \geq V_{OUT}$
- Power Good (PG) Output
- Overcurrent Protection and Thermal Shutdown
- Fixed and Adjustable Output Versions
- Available Package: 8-pin FTQFN 2 x 2 mm

Applications

- USB OTG and HDMI Hosts
- Portable Power Reserve Supplies
- High-Current Parallel Lithium Cell Applications
- Portable Equipment

General Description

The MIC2877 is a compact and highly efficient 2 MHz synchronous boost regulator with a typically 6.5A switch. It features a bidirectional true load disconnect function that prevents any leakage current between the input and output when the device is disabled ($EN = GND$), it protects the input supply and improves the start-up performance.

The MIC2877 has the input voltage range between 2.5V and 5.5V and provides a 2A output continuous current for $V_{IN} = 3.0V$ and $V_{OUT} = 5V$. Fixed and adjustable versions are available.

The MIC2877 operates in Bypass mode automatically when the input voltage is higher or equal to the target output voltage. At light loads, the boost converter goes to Pulse Frequency Modulation (PFM) mode to improve the efficiency. In Shutdown mode ($EN = GND$), the regulator typically consumes less than 2 μA .

The MIC2877 also features an integrated anti-ringing switch to minimize EMI, overvoltage and overcurrent protection, UVLO and thermal shutdown.

The MIC2877 is available in an 8-pin FTQFN 2 x 2 mm package.

Package Types

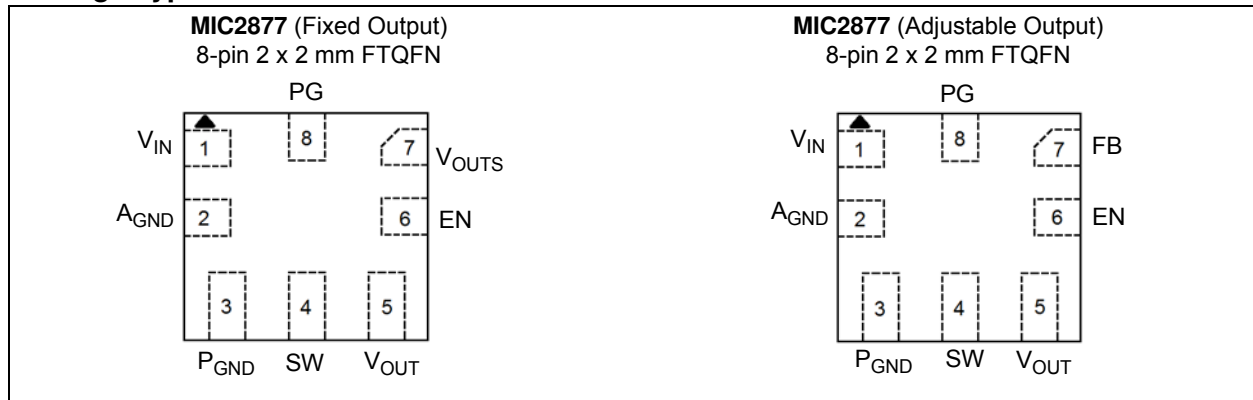

MIC2877

Typical Application Schematics

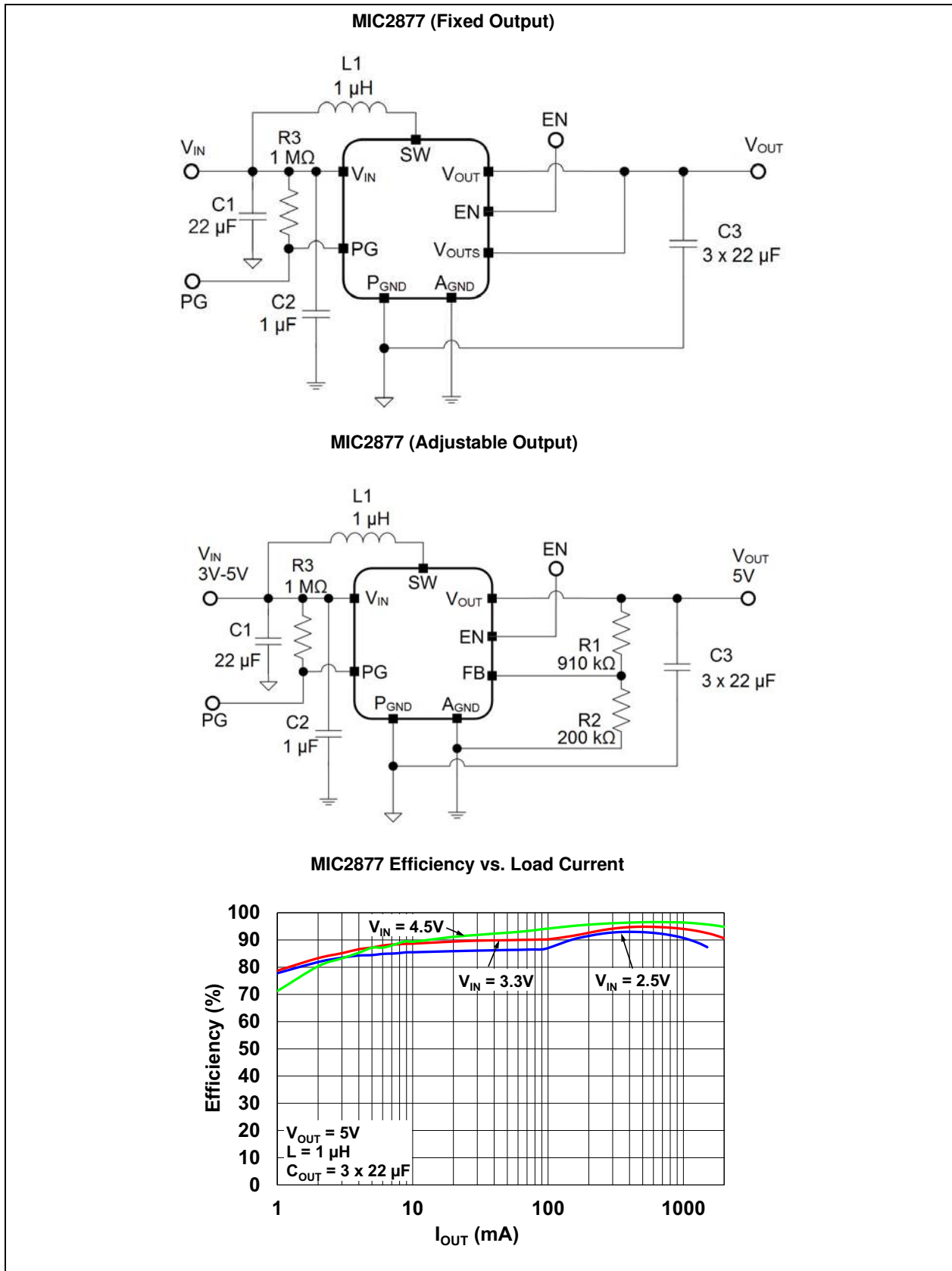

Functional Block Diagrams

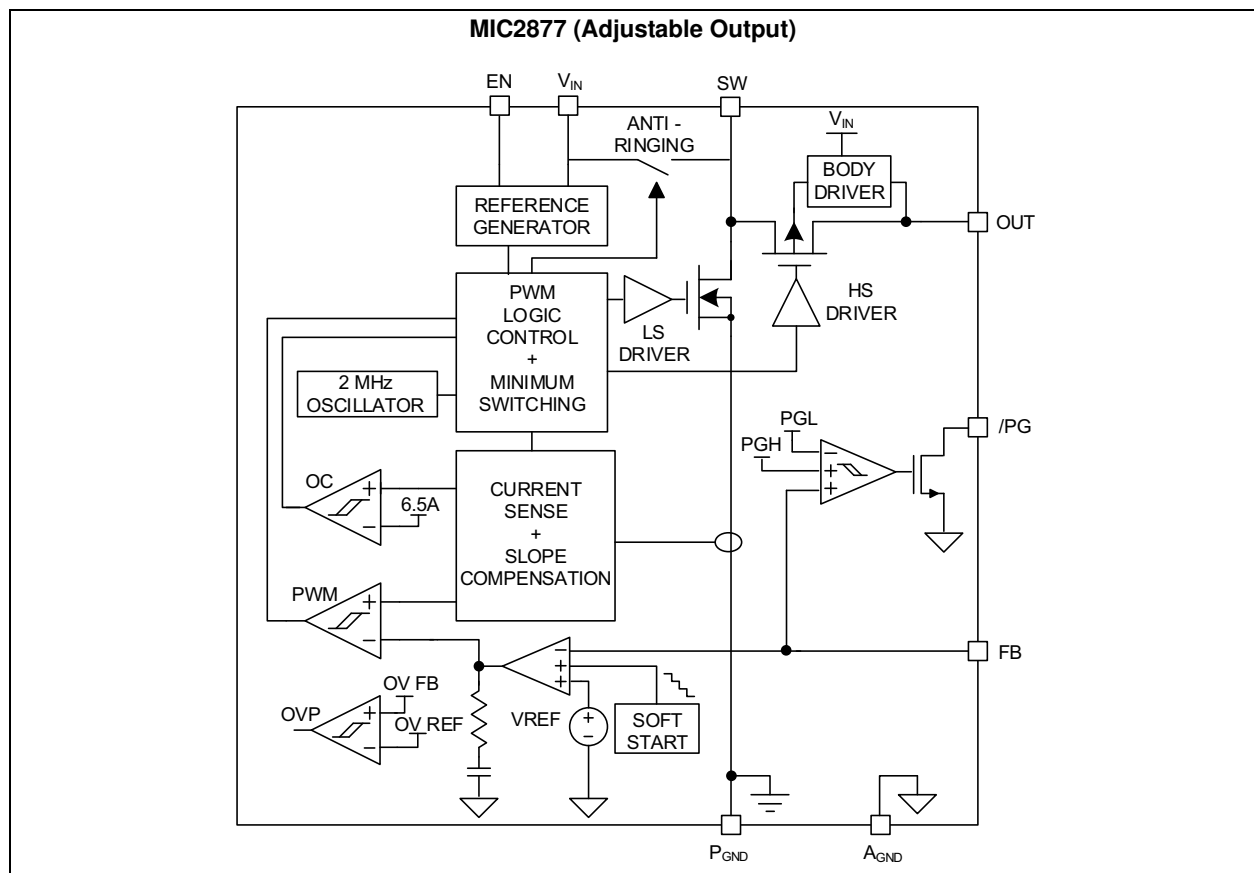
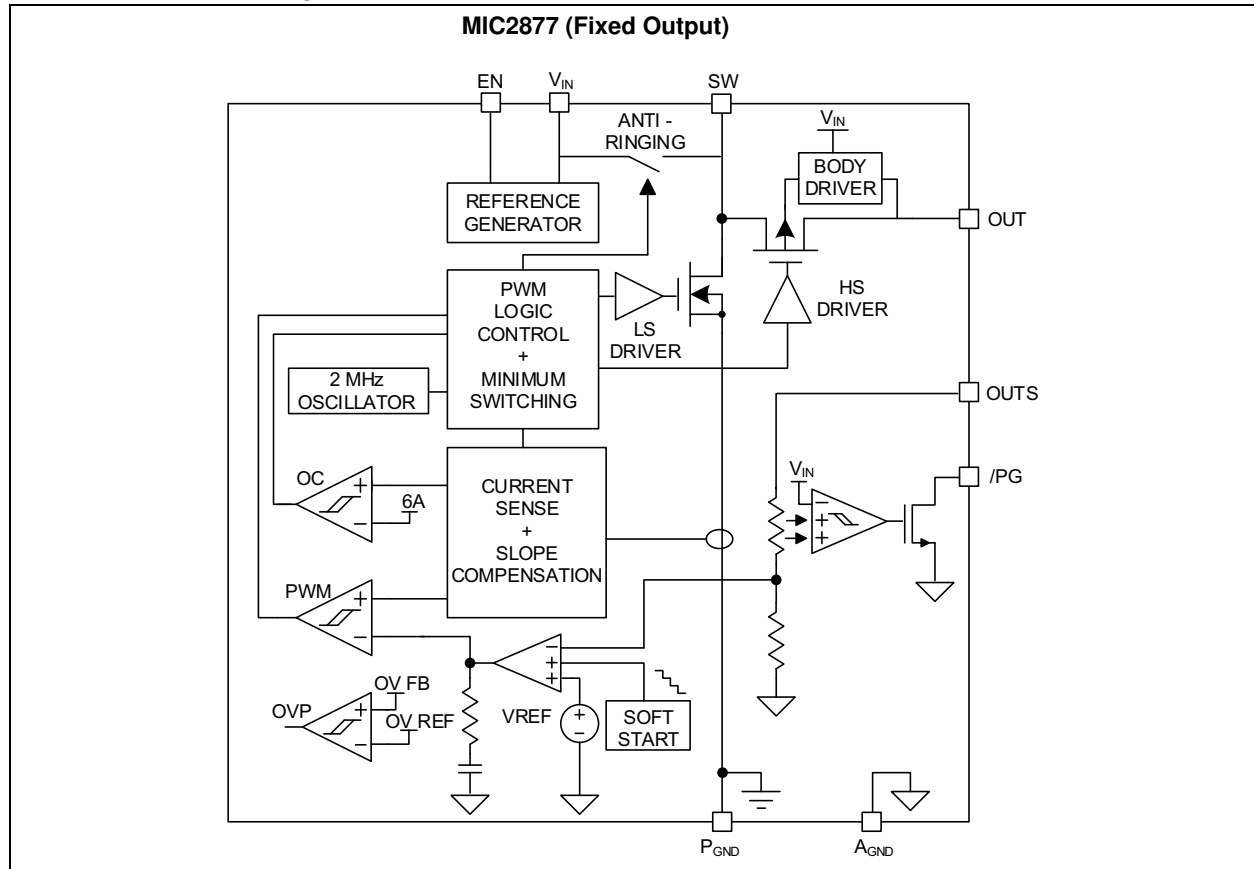

MIC2877

1.0 ELECTRICAL CHARACTERISTICS

Absolute Maximum Ratings †

V_{IN} , EN, OUT, FB/ V_{OUTS} , PG, SW to P_{GND}	-0.3V to +6V
A_{GND} to P_{GND}	-0.3V to +0.3V
EN to A_{GND}	-0.3V to +6V
Power Dissipation	Internally Limited ⁽¹⁾
Lead Temperature (soldering, 10 seconds)	+260°C
Junction Temperature (T_J)	-40°C to +150°C
Storage Temperature (T_S)	-40°C to +150°C
ESD Rating Human Body Model (HBM) ⁽²⁾2 kV
ESD Rating Machine Model (MM) ⁽²⁾	200V

Operating Ratings ‡

Supply Voltage (V_{IN})	+2.5V to +5.5V
Output Voltage (V_{OUT})	V_{IN} to +5.5V
Enable Voltage (V_{EN})	0V to V_{IN}
Junction Temperature (T_J)	-40°C to +125°C
Operating Ambient Temperature (T_A)	-40°C to +85°C
Package Thermal Resistance FTQFN22-8LD (θ_{JA})	+50°C/W

† **Notice:** Stresses above those listed under “Absolute Maximum Ratings” may cause permanent damage to the device. This is a stress rating only and functional operation of the device at those or any other conditions above those indicated in the operational sections of this specification is not intended. Exposure to maximum rating conditions for extended periods may affect device reliability.

‡ **Notice:** The device is not guaranteed to function outside its operating ratings.

Note 1: The maximum allowable power dissipation of any T_A (ambient temperature) is $P_{D(max)} = (T_{J(max)} - T_A)/\theta_{JA}$. Exceeding the maximum allowable power dissipation will result in excessive die temperature, and the regulator will go into thermal shutdown.

2: Devices are ESD sensitive. Handling precautions are recommended. Human body model, 1.5 k Ω in series with 100 pF.

ELECTRICAL CHARACTERISTICS

Electrical Characteristics: $V_{IN} = 3V$, $V_{OUT} = 5V$, $C_{IN} = 22 \mu F$, $C_{OUT} = 3 \times 22 \mu F$, $L = 1 \mu H$, $T_A = +25^\circ C$. **Bold** values are valid for $-40^\circ C \leq T_A < +85^\circ C$, unless otherwise noted. (**Note 1**)

Parameters	Sym.	Min.	Typ.	Max.	Units	Conditions
Power Supply						
Supply Voltage Range	V_{IN}	2.5	—	5.5	V	
Output Voltage	V_{OUT}	V_{IN}	—	5.5	V	
UVLO Rising Threshold	$UVLO_{(r)}$	—	2.29	2.49	V	
UVLO Hysteresis	$UVLO_{HYS}$	—	200	—	mV	
Quiescent Current	I_{VIN}	—	125	180	μA	Non-Switching
V_{IN} Shutdown Current	$I_{VINS D}$	—	1	3	μA	$V_{IN} = 5.5V$, $V_{OUT} = 0V$, $EN = 0$
V_{OUT} Shutdown Current	$I_{VOUT S D}$	—	1	3	μA	$V_{IN} = 0V$, $V_{OUT} = 5.5V$, $EN = 0$
Overtemperature Shutdown Threshold	T_{SD}	—	+155	—	$^\circ C$	
Overtemperature Shutdown Hysteresis	T_{SD-HYS}	—	+15	—	$^\circ C$	
Boost Converter						
Feedback Voltage	V_{FB}	0.8865	—	0.9135	V	Adjustable version
Line Regulation	—	—	0.3	—	%	$2.5V < V_{IN} < 4.5V$, $I_{OUT} = 0.5A$
Load Regulation	—	—	0.2	—	%/A	$I_{OUT} = 300 \text{ mA to } 1.2A$
Overvoltage Protection Threshold	V_{OVD}	6.6	—	6.75	V	
Minimum Controllable On Time	T_{ONMIN}	—	35	—	ns	
Maximum Duty Cycle	D_{MAX}	—	93.6	—	%	
Low-Side Switch Current Limit (Note 2)	I_{SW}	4.8	6.5	7.2	A	$V_{IN} = 3V$, $V_{OUT} = 5V$
Switch-on Resistance	R_{PMOS}	—	45	—	$m\Omega$	$V_{IN} = 3V$, $V_{OUT} = 5V$, $I_{SW} = 200 \text{ mA}$
	R_{NMOS}	—	33	—		
Switch Leakage Current	I_{SW}	—	0.2	5	μA	$V_{EN} = 0V$, $V_{SW} = 5.5V$
Oscillator Frequency	f_{SW}	1.6	2	2.4	MHz	
Pre-Charge Current Limit	$I_{PRE-CHARGE}$	0.27	0.5	0.76	A	$V_{OUT} \leq 0.5V$
		1.7	2.55	3.2		$V_{IN} = 4.5V$, $V_{OUT} = 3V$
Soft Start Charge Time	I_{SS}	—	1.1	2	ms	$V_{OUT} = 5V$, $V_{IN} = 3V$, $C_{OUT} = 22 \mu F \times 3$
EN/PG Control Pins						
EN Threshold (Note 3)	V_{EN}	1.5	—	V_{IN}	V	Device enabled
		—	—	0.4		Device disabled

Note 1: Specification for packaged product only.

2: Data from design and characterization. Not production tested.

3: If the EN pin is externally driven High before V_{IN} is applied, a 200k Ω series resistor is required on the EN signal to the pin.

MIC2877

ELECTRICAL CHARACTERISTICS (CONTINUED)

Electrical Characteristics: $V_{IN} = 3V$, $V_{OUT} = 5V$, $C_{IN} = 22 \mu F$, $C_{OUT} = 3 \times 22 \mu F$, $L = 1 \mu H$, $T_A = +25^\circ C$. **Bold** values are valid for $-40^\circ C \leq T_A < +85^\circ C$, unless otherwise noted. (**Note 1**)

Parameters	Sym.	Min.	Typ.	Max.	Units	Conditions
EN Input Current	—	—	1.5	—	μA	EN = 3V
Power Good Threshold (Rising)	V_{PG-THR}	—	$0.91 \times V_{FB}$	—	V	Adjustable version
		—	$0.91 \times V_{OUT}$	—		Fixed version
Power Good Threshold (Falling)	V_{PG-THF}	—	$0.82 \times V_{FB}$	—	V	Adjustable version
		—	$0.83 \times V_{OUT}$	—		Fixed version

Note 1: Specification for packaged product only.

2: Data from design and characterization. Not production tested.

3: If the EN pin is externally driven High before V_{IN} is applied, a 200k Ω series resistor is required on the EN signal to the pin.

TEMPERATURE SPECIFICATIONS

Parameters	Sym.	Min.	Typ.	Max.	Units	Conditions
Temperature Ranges						
Power Dissipation	—	—	—	—	—	Internally Limited ⁽¹⁾
Lead Temperature	—	—	—	+260	$^\circ C$	Soldering, 10s
Junction Temperature	T_J	-40	—	+125	$^\circ C$	
Storage Temperature	T_S	-40	—	+150	$^\circ C$	
Operating Ambient Temperature	T_A	-40	—	+85	$^\circ C$	
Package Thermal Resistances						
Thermal Resistance FTQFN22-8LD	θ_{JA}	—	+50	—	$^\circ C/W$	

Note 1: The maximum allowable power dissipation of any T_A (ambient temperature) is

$P_{D(max)} = (T_{J(max)} - T_A) / \theta_{JA}$. Exceeding the maximum allowable power dissipation will result in excessive die temperature, and the regulator will go into thermal shutdown.

2.0 TYPICAL PERFORMANCE CURVES

Note: The graphs and tables provided following this note are a statistical summary based on a limited number of samples and are provided for informational purposes only. The performance characteristics listed herein are not tested or guaranteed. In some graphs or tables, the data presented may be outside the specified operating range (e.g., outside specified power supply range) and therefore outside the warranted range.

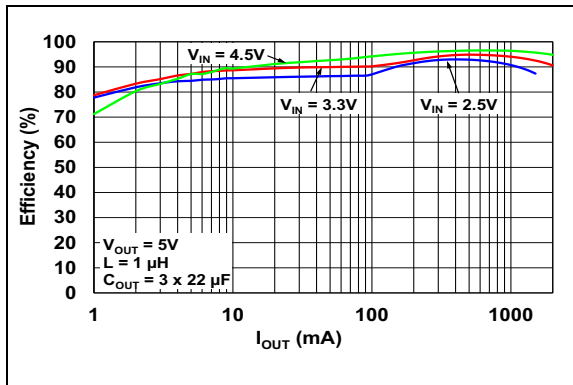

FIGURE 2-1: Efficiency vs. Load Current, Adjustable Output Version.

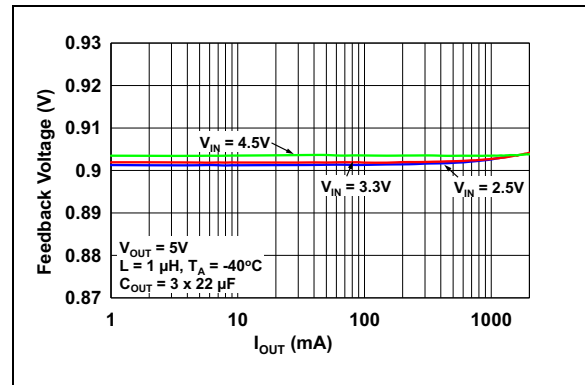

FIGURE 2-4: Feedback Voltage vs. Load Current ($T_A = -40^\circ\text{C}$), Adjustable Output Version.

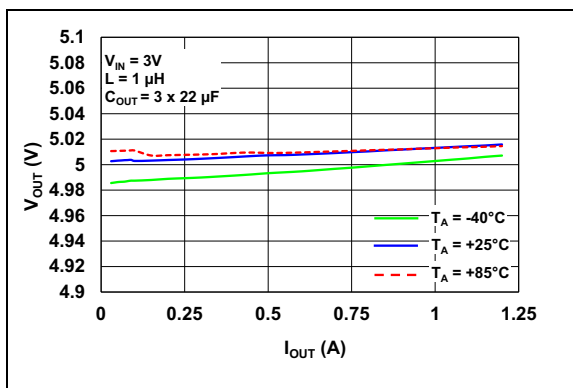

FIGURE 2-2: Output Voltage vs. Load Current, Adjustable Output Version.

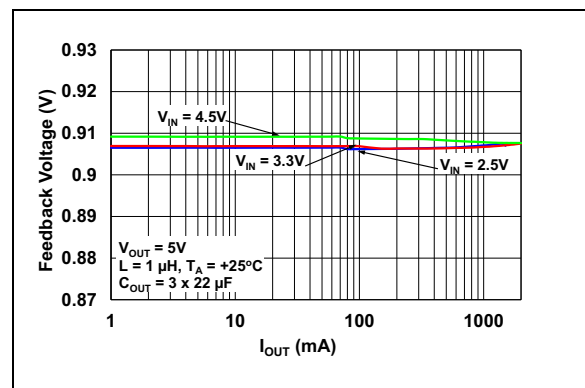

FIGURE 2-5: Feedback Voltage vs. Load Current ($T_A = +25^\circ\text{C}$), Adjustable Output Version.

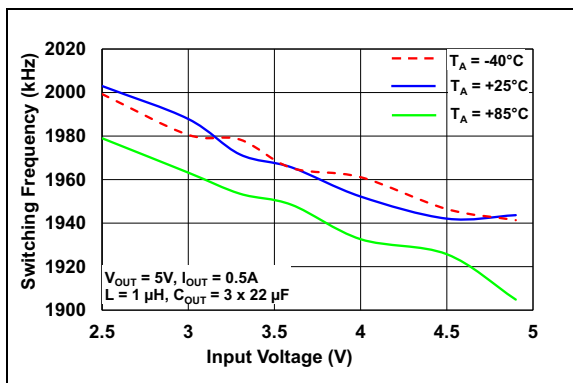

FIGURE 2-3: Switching Frequency vs. Input Voltage, Adjustable Output Version.

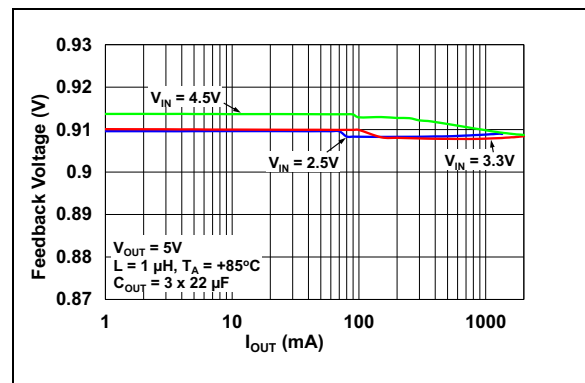

FIGURE 2-6: Feedback Voltage vs. Load Current ($T_A = +85^\circ\text{C}$), Adjustable Output Version.

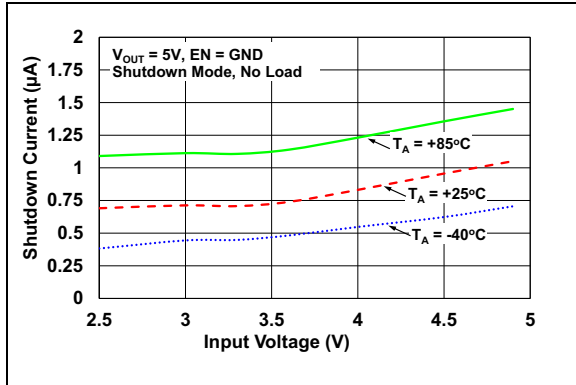

FIGURE 2-7: Shutdown Current vs. Input Voltage, Adjustable Output Version.

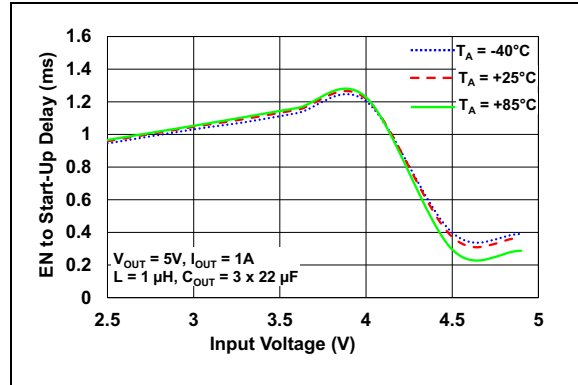

FIGURE 2-10: Enable to Start-Up Delay vs. Input Voltage, Adjustable Output Version.

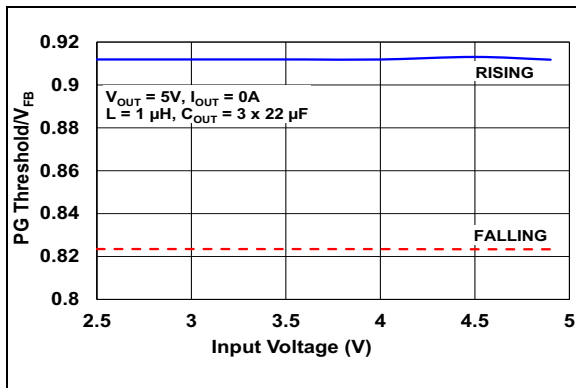

FIGURE 2-8: Power Good Threshold vs. Input Voltage, Adjustable Output Version.

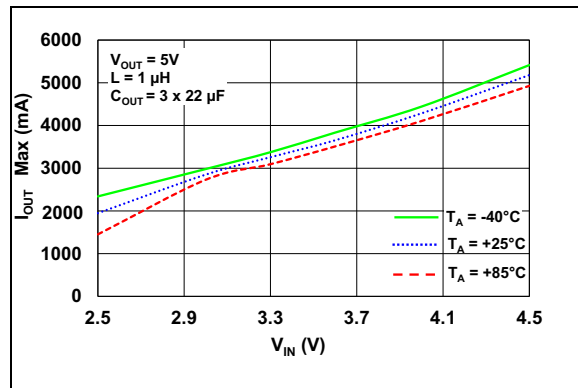

FIGURE 2-11: Maximum Output Current vs. Input Voltage, Adjustable Output Version.

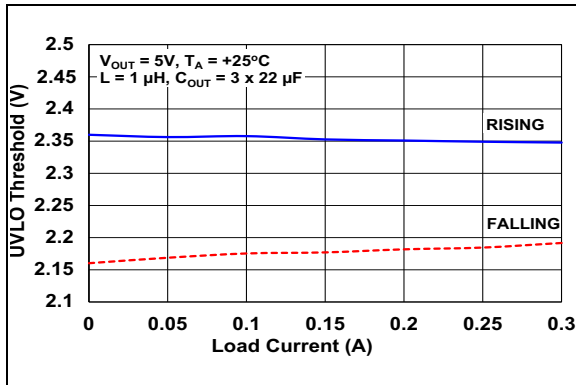

FIGURE 2-9: UVLO Threshold vs. Load Current, Adjustable Output Version.

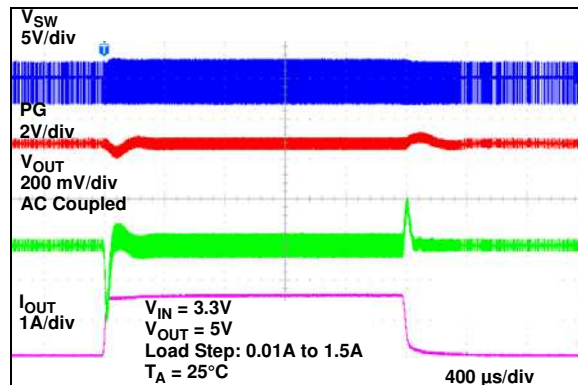

FIGURE 2-12: Load Transient ($V_{IN} = 3.3V$), Adjustable Output Version.

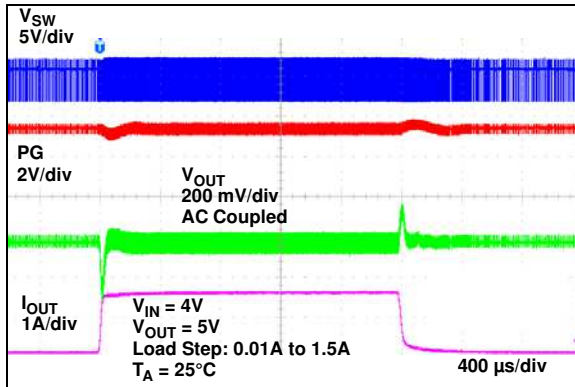

FIGURE 2-13: Load Transient ($V_{IN} = 4V$), Adjustable Output Version.

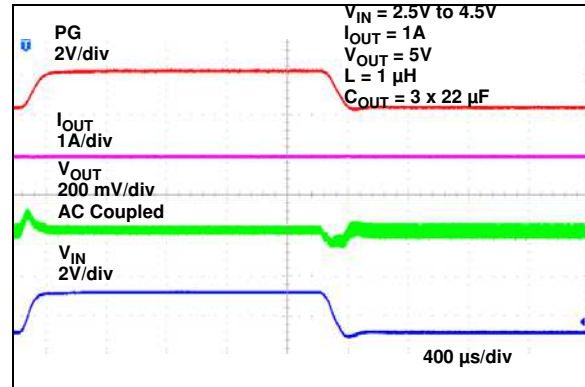

FIGURE 2-16: Line Transient ($V_{IN} = 2.5V$ to $4.5V$), Adjustable Output Version.

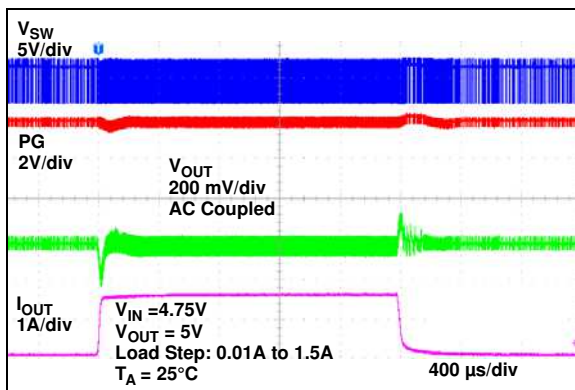

FIGURE 2-14: Load Transient ($V_{IN} = 4.75V$), Adjustable Output Version.

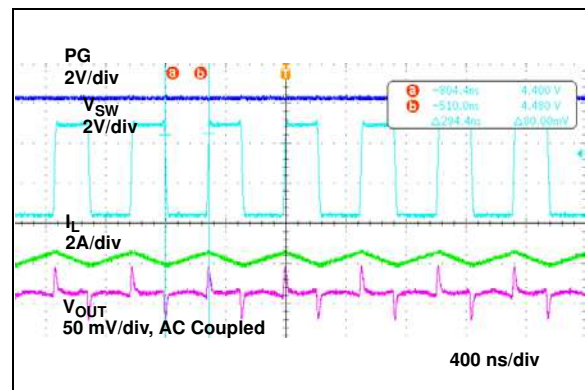

FIGURE 2-17: Switching Waveforms ($V_{IN} = 2.5V$, $V_{OUT} = 5V$, $I_{OUT} = 1.5A$), Adjustable Output Version.

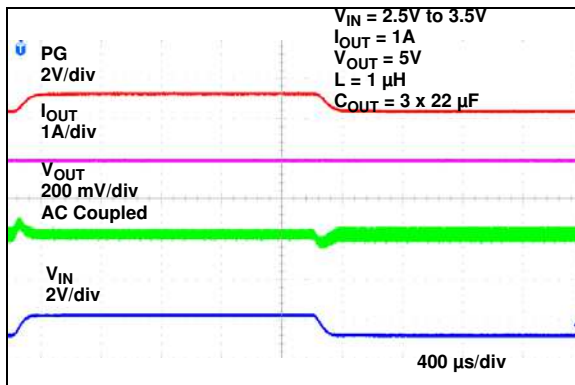

FIGURE 2-15: Line Transient ($V_{IN} = 2.5V$ to $3.5V$), Adjustable Output Version.

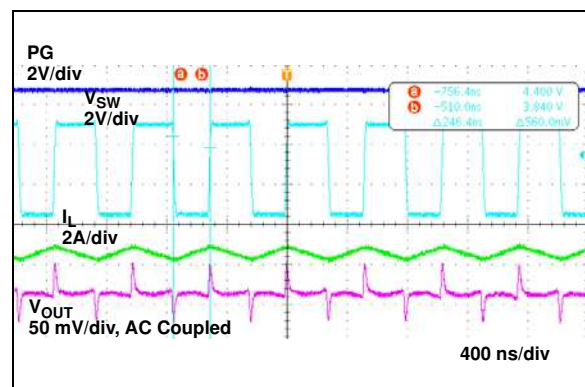

FIGURE 2-18: Switching Waveforms ($V_{IN} = 3V$, $V_{OUT} = 5V$, $I_{OUT} = 2A$), Adjustable Output Version.

MIC2877

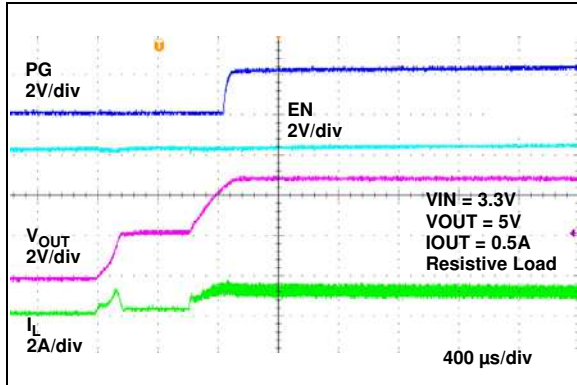

FIGURE 2-19: Soft Start in Boost Mode, Adjustable Output Version.

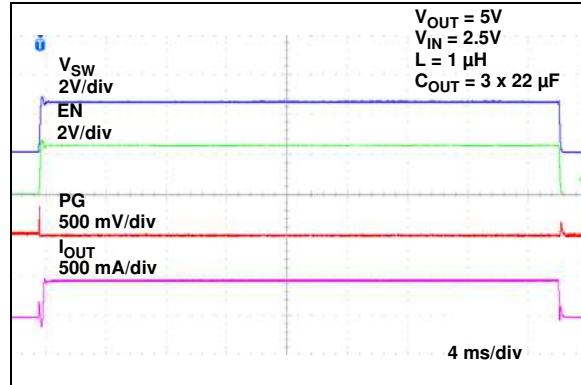

FIGURE 2-22: Start-Up in Short Circuit ($V_{IN} = 2.5V$, $T_A = +25^{\circ}C$), Adjustable Output Version.

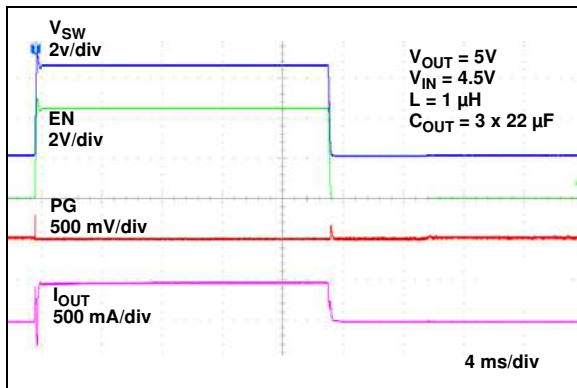

FIGURE 2-20: Start-Up in Short Circuit ($V_{IN} = 4.5V$, $T_A = +25^{\circ}C$), Adjustable Output Version.

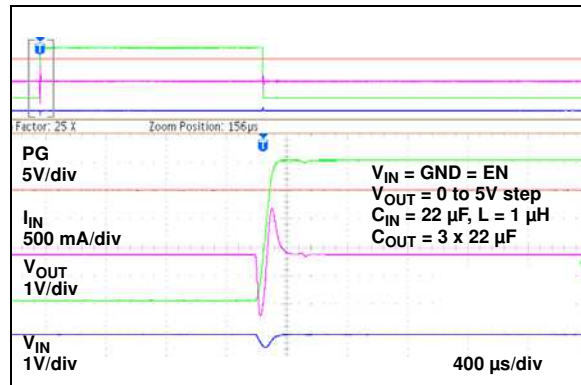

FIGURE 2-23: Bidirectional True Shutdown. Shorted Input, Output Step from 0V to 5V with $EN = 0V$. Adjustable Output Version.

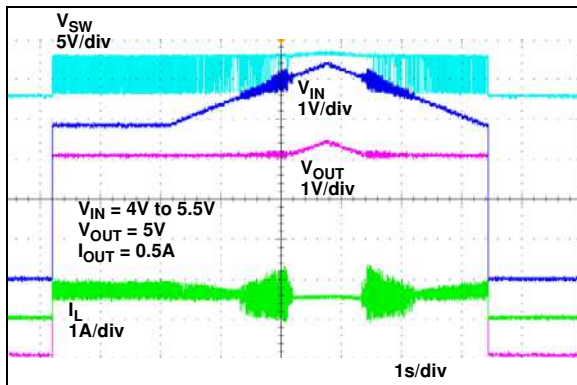

FIGURE 2-21: Bypass Mode, Adjustable Output Version.

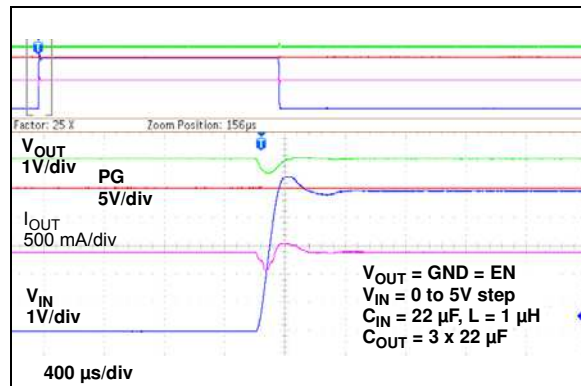

FIGURE 2-24: Bidirectional True Shutdown. Shorted Output, Supply Step from 0V to 5.0V with $EN = 0V$. Adjustable Output Version.

3.0 PIN DESCRIPTIONS

The descriptions of the pins are listed in [Table 3-1](#).

TABLE 3-1: PIN FUNCTION TABLE

MIC2877 (for Fixed and Adjustable Output)	Symbol	Description
1	V_{IN}	Input Voltage Pin. Connect a minimum 22 μ F ceramic capacitor between V_{IN} and P_{GND} .
2	A_{GND}	Analog Ground Pin
3	P_{GND}	Power Ground Pin
4	SW	Switch Node, Boost Inductor Input Pin
5	V_{OUT}	Boost Converter Output Pin. Connect at least 3 x 22 μ F ceramic capacitors between V_{OUT} and P_{GND} .
6	EN	Enable Pin. When this pin is driven low, the IC enters Shutdown mode (device disabled). It should not be left floating. Connect it to V_{IN} using a 10 k Ω resistor.
7	V_{OUTS}	Output Voltage Sensing Pin for the fixed output voltage variant only.
	FB	Feedback Pin for the adjustable output voltage variant only.
8	PG	Power Good Pin. It is an open drain output, it should be connected to a pull-up resistor.

MIC2877

4.0 DETAILED DESCRIPTION

4.1 Voltage Input (V_{IN})

The input supply provides power to the internal MOSFET gate drivers and control circuitry for the boost regulator. The operating input voltage range is from 2.5V to 5.5V. A 1 μ F low-ESR ceramic input capacitor should be connected from the V_{IN} pin to A_{GND} , as close to the MIC2877 as possible, to ensure a clean supply voltage for the device. A minimum voltage rating of 10V is recommended for this input capacitor. A 22 μ F low-ESR ceramic capacitor should also be connected between the input pin and the power ground (P_{GND}), with a 10V minimum voltage rating.

4.2 Switch Node (SW)

The MIC2877 has internal low-side and synchronous MOSFET switches. The switch node (SW) between the internal MOSFET switches connects directly to one end of the inductor and provides the current path during switching cycles. The other end of the inductor is connected to the input supply voltage. Due to the high-speed switching on this pin, the switch node should be routed away from sensitive nodes wherever possible.

4.3 Analog Ground (A_{GND})

The analog ground path (A_{GND}) is dedicated to the internal biasing and control circuitry. The current loop of the analog ground should be separated from the power ground (P_{GND}) path. The A_{GND} should be connected to the P_{GND} in a single point, very close to the regulator.

4.4 Power Ground (P_{GND})

The power ground (P_{GND}) is the ground path for the high current in the boost switches. The current loop for the power ground should be as short as possible and separate from the A_{GND} loop as applicable.

4.5 Boost Converter Output (V_{OUT})

Three parallel low-ESR ceramic capacitors of 22 μ F each should be connected from the V_{OUT} and P_{GND} , as close as possible to the MIC2877. A minimum voltage rating of 10V is recommended for the output capacitors.

4.6 Enable (EN)

Logic high on the EN pin of the MIC2877 enables the regulator. When this pin is driven low, the MIC2877 goes to Shutdown mode. Even if it is internally pulled down by a 2.5 M Ω resistor, this pin should not be left floating.

4.7 Feedback/Output Voltage Sense (FB/ V_{OUTS})

This is a feedback or output voltage sensing pin for the boost converter. For the fixed voltage version, this pin must be connected directly to the V_{OUT} pin. For the adjustable version, connect a resistor divider to set the output voltage (see [Section 5.7, Output Voltage Programming](#) for more information).

4.8 Power Good Output (PG)

A power good (PG) pin is provided to monitor the power good function. It is an open drain active high output. The PG pin must be connected to V_{IN} through a 1 M Ω pull-up resistor. This pin is asserted high when the output voltage is higher than 91% of its nominal voltage.

5.0 APPLICATION INFORMATION

5.1 General Description

The MIC2877 is a 2 MHz, current-mode, PWM, synchronous boost converter with an operating input voltage range of 2.5V to 5.5V. At light load, the converter enters PFM mode to maintain a high efficiency over a wide range of load current. The maximum peak current in the boost switch is limited to 6.5A (typical).

5.2 Bidirectional Output Disconnect

The power stage of the MIC2877 consists of an NMOS transistor as the main switch and a PMOS transistor as the synchronous rectifier. A control circuit turns off the back gate diode of the PMOS to isolate the output from the input supply when the chip is disabled ($V_{EN} = 0V$).

5.3 Integrated Anti-Ringing Switch

The MIC2877 includes an anti-ringing switch that eliminates the ringing on the SW node of a conventional boost converter operating in the Discontinuous Conduction mode (DCM). At the end of a switching cycle during DCM operation, both the NMOS and PMOS are turned off. The anti-ringing switch in the MIC2877 clamps the SW pin voltage to the input, to dissipate the remaining energy stored in the inductor and the parasitic elements of the power switches.

5.4 Automatic Bypass Mode (for $V_{IN} > V_{OUT}$)

The MIC2877 automatically operates in Bypass mode when the input voltage is higher or equal to the target output voltage. In Bypass mode, the NMOS is turned off while the PMOS is fully turned on to provide a very low impedance path from IN to OUT.

5.5 Pre-Charge Current Limit

For MIC2877, a pre-charge current limit circuit is used during start-up phase, to limit the inrush current to 0.5A (typical), when $V_{OUT} < 0.5V$. Then, the current limit will gradually increase to 2.55A when V_{OUT} rises to 3V. If a heavy load (lower than 1Ω) is connected to the output during start-up, the converter will stay in the pre-charge state and limit the output current to 0.5A. The pre-charge current limit essentially provides a start-up short circuit protection to prevent part damage.

5.6 Soft Start

The MIC2877 integrates an internal soft start circuit to limit the inrush current during start-up. When the device is enabled, the PMOS is turned on slowly to charge the output capacitor to a voltage close to the input voltage. Then, the device starts boost switching cycles to gradually increase the output voltage to the targeted V_{OUT} . A 500 μs timer is provided to soft start the internal reference voltage. This timer sets the soft-start time by charging a capacitor with a reference current.

5.7 Output Voltage Programming

The MIC2877 has an adjustable version that allows the output voltage to be set by an external resistor divider (R1 and R2). The typical feedback voltage is 0.9V. The current through the resistor divider should be significantly larger than the current into the FB pin. It is recommended that the total resistance of $R1 + R2$ should be less than about 1 M Ω for accurate output voltage setting. The appropriate R1 and R2 values for the desired output voltage are calculated as in [Equation 5-1](#):

EQUATION 5-1:

$$R1 = R2 \times \left(\frac{V_{OUT}}{0.9V} - 1 \right)$$

5.8 Overvoltage Protection

When the output voltage rises above the OVP threshold (maximum 6.75V) for any reason, the whole device is latched off automatically to avoid the IC permanent damage. To clear the latch-off condition, either recycle the input supply or deassert the EN pin.

5.9 Thermal Shutdown

When the internal die temperature reaches +155°C, the boost converter is disabled. The device will resume its normal operation until the die temperature falls below +140°C (+15°C hysteresis).

5.10 Overcurrent Protection

The MIC2877 has a current limit feature to protect the part against heavy load conditions. When the current limit comparator determines that the NMOS switch has a peak current higher than 6.5A (typ.), the NMOS is turned off and the PMOS is turned on until the next switching cycle. The current limit protection is reset cycle by cycle.

5.11 Working with Inductive or Active Loads

The MIC2877 is designed for on-board power conversion and with on-board loads in mind, where stray inductance is very small. This allows for a very compact solution, with a small amount of input and output capacitance. When using the MIC2877 with remote, inductive (e.g., load boards with long leads, or large rheostats) or active loads, it is recommended to add a Schottky diode (20V, 0.5A-1A ratings) with the anode connected to ground, and cathode connected to the output of the MIC2877 board. This is done to prevent the output from being pulled below ground, which may damage the part.

This precaution is especially important when exercising protections (e.g., thermal shutdown) or when exercising any other condition that may trigger protections and shut down the part. When the protection triggers, the current delivered by the MIC2877 will exhibit a sudden change. If significant inductance is present on the load side or if the current sink capability of the load is maintained down to very low voltages, the output may be pulled below ground by more than 0.3V, thus exceeding the absolute maximum ratings of the device.

5.12 Input Bulk Capacitor

A similar phenomenon may also endanger the part from the input side, especially when using high-input voltages. Long power supply leads are inductive. When the protection triggers, or when the load drops very rapidly in normal conditions, the current consumption of the MIC2877 will also exhibit a sudden change. The lead inductance will therefore discharge into the input capacitor, thus causing the input voltage to rise. If the input capacitance at the MIC2877 is too small, the input voltage spike may rise to a point where the device is damaged. If the input supply to the MIC2877 has some significant stray inductance and it is close to the maximum rating, the input bulk capacitor is mandatory. The capacitor's value can be increased as needed to keep the overvoltage within safe limits. Since the current change through the MIC2877 is instantaneous, the ESR of the input bulk capacitor should also be small.

6.0 COMPONENT SELECTION

6.1 Inductor

The inductor selection is a trade-off between efficiency, stability, cost, size and rated current. Since the boost converter is compensated internally, the recommended inductance is limited to 1 μH , to ensure system stability.

The saturation current rating of the selected inductor must be higher than the maximum expected peak inductor current and should be at least 20% to 30% higher than the average inductor current at maximum output current.

6.2 Input Capacitor to the Device Supply

A ceramic capacitor of 1 μF or larger with low ESR is recommended to reduce the input voltage ripple and to ensure a clean supply voltage for the device. The input capacitor should be placed as close as possible to the MIC2877 V_{IN} and A_{GND} pins with short traces to ensure good switching noise suppression performance. X5R or X7R type ceramic capacitors are recommended for better tolerance over temperature. The Y5V and Z5U type temperature rating ceramic capacitors are not recommended due to their large reduction in capacitance over temperature and increased resistance at high frequencies. The use of these reduces their ability to filter the high-frequency noise. The rated voltage of the input capacitor should be at least 20% higher than the maximum operating input voltage over the operating temperature range.

6.3 Input Capacitor to the Power Path

A ceramic capacitor of a 22 μF or larger with low ESR is recommended, to reduce the input voltage fluctuation at the voltage supply of the high-current power path. This input capacitor should be placed close to the V_{IN} supply of the power inductor and the P_{GND} for good device performance under heavy loads. X5R or X7R-type ceramic capacitors are recommended for better tolerance over temperature.

The Y5V and Z5U type temperature rating ceramic capacitors are not recommended due to their large reduction in capacitance over temperature and increased resistance at high frequencies. These reduce their ability to filter out high-frequency noise. The rated voltage of the input capacitor should be at least 20% higher than the maximum operating input voltage over the operating temperature range.

6.4 Output Capacitor

The output capacitor selection is also a trade-off between performance, size and cost. Increasing the output capacitor will lead to an improved transient response; however, the size and cost also increase. Three 22 μF output capacitors with ESR less than 10 $\text{m}\Omega$ are required, while X5R or X7R type ceramic capacitors are recommended for better tolerance over temperature. Additional capacitors can be added to improve the transient response, and to reduce the output ripple when the MIC2877 operates in and out of Bypass mode.

The Y5V and Z5U type ceramic capacitors are not recommended due to their wide capacitance variation over temperature and increased resistance at high frequencies. The rated voltage of the output capacitor should be at least 20% higher than the maximum operating output voltage over the operating temperature range. A 0805 size ceramic capacitor is recommended for a smaller ESL of the output capacitor, which contributes to a smaller voltage spike of the output voltage of the high frequency switching boost converter.

7.0 POWER DISSIPATION

As with all power devices, the ultimate current rating of the output is limited by the thermal properties of the device package and the PCB on which the device is mounted. There is a simple, Ohm's law-type relationship between thermal resistance, power dissipation, and temperature which are analogous to an electrical circuit (see [Figure 7-1](#)):

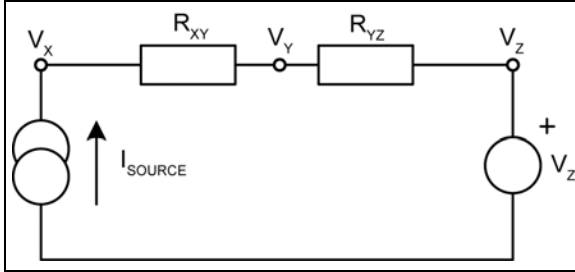

FIGURE 7-1: Series Electrical Resistance Circuit.

From this simple circuit, we can calculate the V_X if we know the I_{SOURCE} , V_Z , and the resistor values, R_{XY} and R_{YZ} , using [Equation 7-1](#):

EQUATION 7-1:

$$V_X = I_{SOURCE} \times (R_{XY} + R_{YZ}) + V_Z$$

Thermal circuits can be considered using this same rule and can be drawn similarly by replacing current sources with power dissipation (in W), resistance with thermal resistance (in $^{\circ}\text{C}/\text{W}$) and voltage sources with temperature (in $^{\circ}\text{C}$).

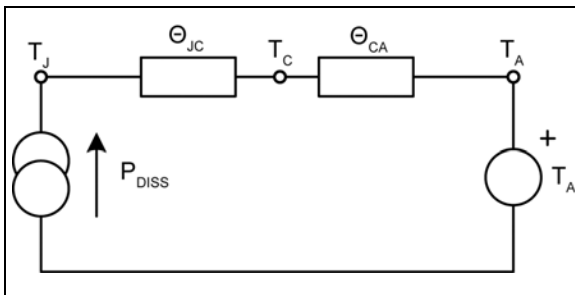

FIGURE 7-2: Series Thermal Resistance Circuit.

By replacing the variables in the equation for V_X , we can find the junction temperature (T_J) from the power dissipation, ambient temperature and the known thermal resistance of the PCB (θ_{CA}) and the package (θ_{JC}).

EQUATION 7-2:

$$T_J = P_{DISS} \times (\theta_{JC} + \theta_{CA}) + T_A$$

Where P_{DISS} is explained in [Equation 7-4](#).

As the diagram shows, the total thermal resistance is $\theta_{JA} = \theta_{JC} + \theta_{CA}$. This can also be written as in [Equation 7-3](#):

EQUATION 7-3:

$$T_J = P_{DISS} \times (\theta_{JA}) + T_A$$

Given that all of the power losses (minus the inductor losses) that are effectively in the converter are dissipated within the MIC2877 package, P_{DISS} can be estimated thusly:

EQUATION 7-4: BOOST MODE

$$P_{DISS} = \left[P_{OUT} \times \left(\frac{1}{\eta} - 1 \right) \right] - \left(\frac{I_{OUT}}{1-D} \right)^2 \times DCR$$

Where D is the Duty Cycle and is explained in [Equation 7-5](#).

EQUATION 7-5: DUTY CYCLE (BOOST)

$$D = \frac{V_{OUT} - V_{IN}}{V_{OUT}}$$

In the equations above, η is the efficiency taken from the efficiency curves and DCR represents the inductor DCR. θ_{JA} can be found in [Section "Operating Ratings †"](#).

8.0 PCB LAYOUT GUIDELINES

The PCB layout is critical to achieve reliable, stable and efficient performance. A ground plane is required to control EMI and minimize the inductance in power, signal and return paths. The following guidelines should be followed to ensure proper operation of the device:

8.1 Integrated Circuit (IC)

- Place the IC close to the point of load.
- Use thick traces to route the input and output power lines.
- Analog grounds and power ground should be kept separate and connected at a single location.
- Place as many thermal vias as possible close to the regulator and connect them to the ground plane (preferably on the bottom layer) to ensure a good PCB thermal resistance can be achieved.

8.2 V_{IN} Decoupling Capacitor

- The input decoupling capacitor must be placed very close to the V_{IN} pin of the IC and preferably connected directly to the pin and not through vias.
- The V_{IN} decoupling capacitor should be connected as close as possible to the A_{GND} pin.
- The V_{IN} terminal is noise sensitive and the placement of the capacitor is very critical.

8.3 V_{IN} Power Path Capacitor

- The V_{IN} power path capacitor should be placed and connected close to the V_{IN} supply of the power inductor and the P_{GND} pin of the IC.
- Vias should not be used to connect the capacitor to V_{IN} .

8.4 Inductor

- Keep the inductor connections to the switch node (SW) and to the input power line short and wide enough to handle the switching current. Keep the areas of the switching current loops small to minimize the EMI problem.
- Do not route any digital lines underneath or close to the inductor.
- Keep the switch node (SW) away from the noise sensitive pins.
- To minimize the noise, place a ground plane underneath the inductor.

8.5 Output Capacitor

Use wide and short traces to connect the output capacitor as close as possible to the V_{OUT} and P_{GND} pins without going through via holes to minimize the switching current loop during the main switch-off cycle and the switching noise.

The location of the output capacitor is very important for any boost converter. It should be placed as close as possible to the IC. The parasitic inductance between the regulator and the output capacitors must be minimized, as it causes voltage spikes and ringing on the SW pin. If these voltage spikes are too high, they can lead to IC damage and the corresponding ringing causes EMI problems.

In the MIC2877 case, for a very small parasitic inductance, it is recommended to place the three 0805 output capacitors in parallel, very close to the IC:

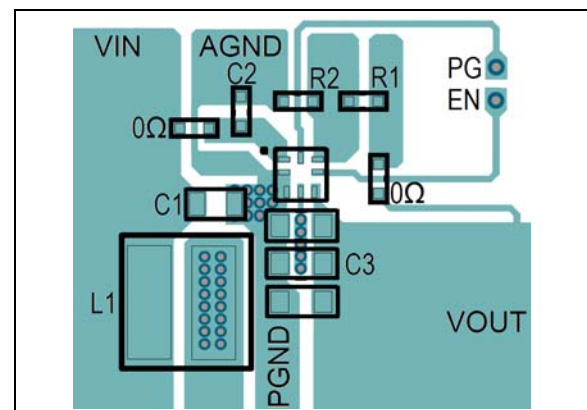

FIGURE 8-1: Recommended Output Capacitors Placement on the MIC2877 PCB Layout (See [Typical Application Schematics](#)).

The SW pin should be connected to the power inductor using a bottom copper plane and the connection between the SW pin and this bottom plane should be done using several vias placed between the output capacitors pads, while the connection of the copper plane to the inductor should be done using several vias placed very close or under the coil pad.

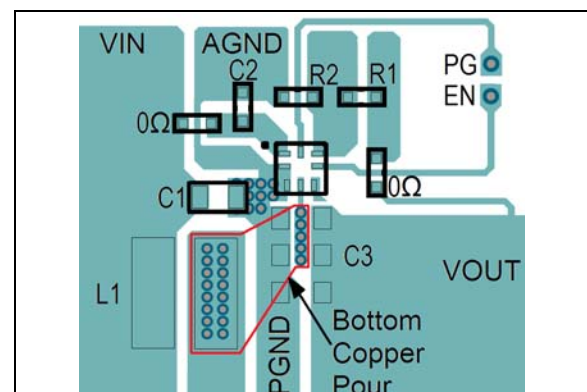

FIGURE 8-2: Recommended Routing of the SW Pin to the Power Inductor.

MIC2877

9.0 PACKAGING INFORMATION

9.1 Package Marking Information

8-Lead FTQFN 2 x 2 mm

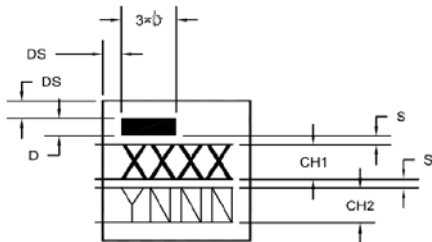

Example

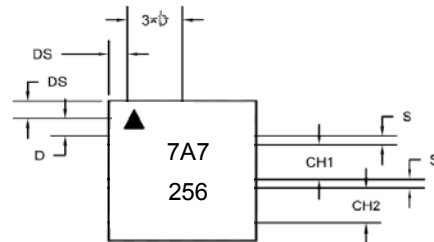

Device	Code
MIC2877-AYFT-TR	7A7
MIC2877-4.75YFT-TR	7F7
MIC2877-5.0YFT-TR	7G7
MIC2877-5.25YFT-TR	7H7
MIC2877-5.5YFT-TR	7J7

<p>Legend: XX...X Product code or customer-specific information Y Year code (last digit of calendar year) YY Year code (last 2 digits of calendar year) WW Week code (week of January 1 is week '01') NNN Alphanumeric traceability code (e3) Pb-free JEDEC® designator for Matte Tin (Sn) * This package is Pb-free. The Pb-free JEDEC designator ((e3)) can be found on the outer packaging for this package.</p> <p>•, ▲, ▼ Pin one index is identified by a dot, delta up, or delta down (triangle mark).</p>	<p>Note: In the event the full Microchip part number cannot be marked on one line, it will be carried over to the next line, thus limiting the number of available characters for customer-specific information. Package may or may not include the corporate logo.</p> <p>Underbar (_) symbol may not be to scale.</p>
--	--

TITLE

8 LEAD FTQFN 2.0x2.0 mm PACKAGE (Flip Chip) OUTLINE & RECOMMENDED LAND PATTERN

DRAWING #	FTQFN22-8LD-PL-1	UNIT	MM
-----------	------------------	------	----

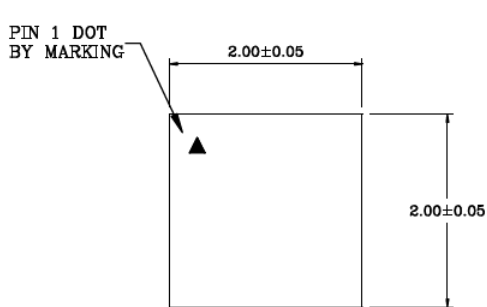

Top View

NOTE: 1,2,3

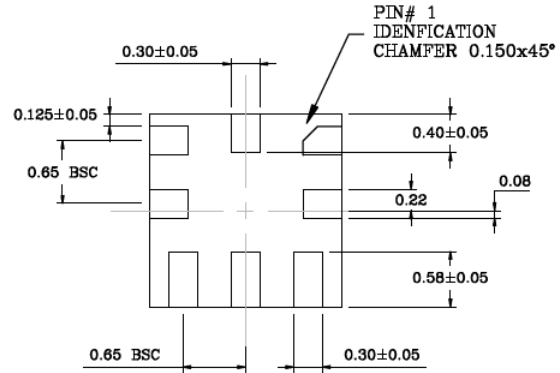

Bottom View

NOTE: 2,3

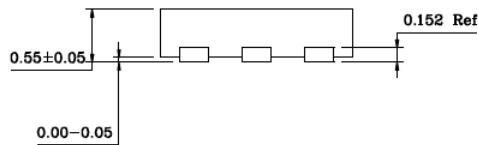

Side View

NOTE: 2,3

NOTES:

1. Top mark Pin #1 will be laser mark.
2. 0.05mm max package warpage.
3. Max allowable burr is 0.076mm in all directions.
4. Green, Blue and Red color pads represent different potential. Do not connect to GND.
5. Black color pads represent different IOs. Do not connect together.
6. Shaded rectangles (area) represents solder stencil opening on exposed metal trace.
7. Recommended Land Pattern Tolerance is ± 0.020 mm unless specified.
8. See recommended Land Pattern on page 2.

Note: For the most current package drawings, please see the Microchip Packaging Specification located at <http://www.microchip.com/packaging>.

MIC2877

POD-Land Pattern Doc #: FTQFN22-8LD-PL-1-A

Recommended Land Pattern

Note: 4,5,6,7

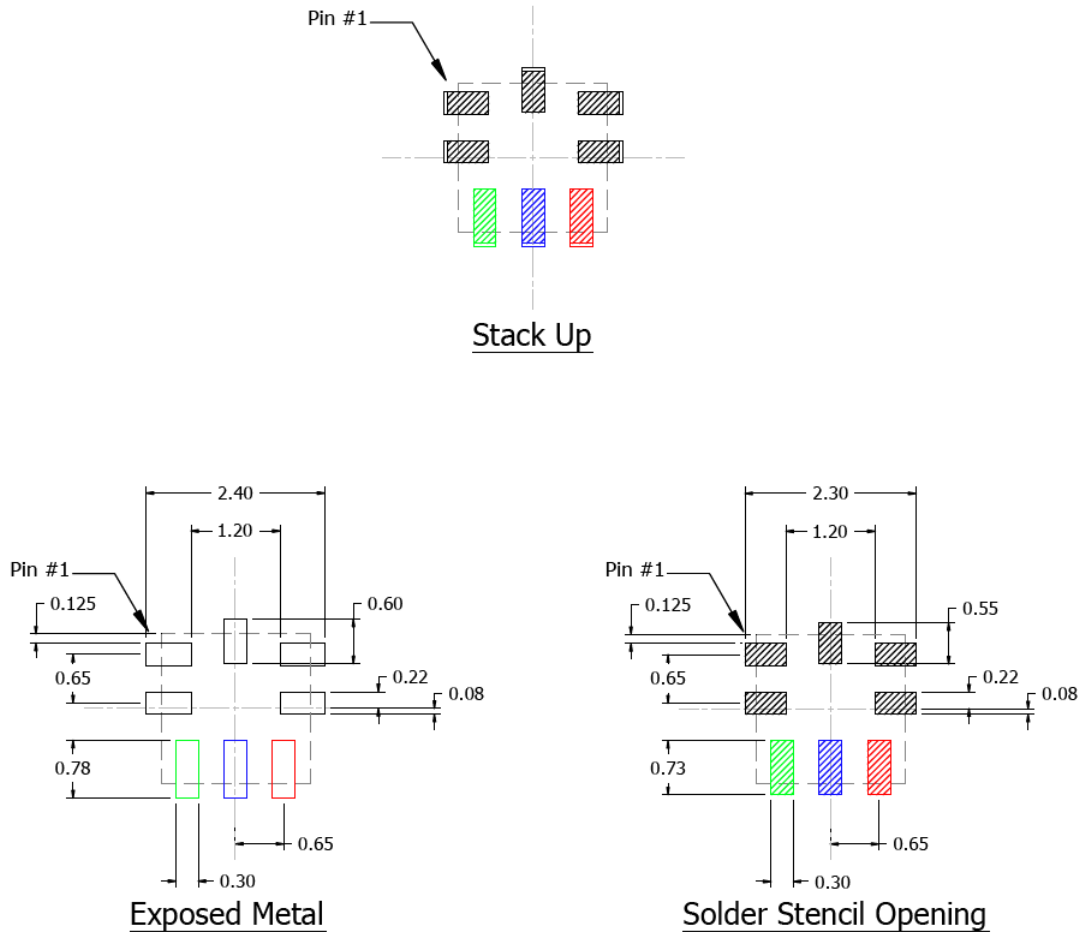

Note: For the most current package drawings, please see the Microchip Packaging Specification located at <http://www.microchip.com/packaging>.

APPENDIX A: REVISION HISTORY

Revision A (November 2017)

- Original Release of this Document.

MIC2877

NOTES:

PRODUCT IDENTIFICATION SYSTEM

To order or obtain information, e.g., on pricing or delivery, contact your local Microchip representative or sales office.

<u>PART NO.</u>	-	<u>XX</u>		<u>X</u>		<u>XX</u>	-	<u>XX</u>
Device		Output Voltage		Temperature		Package		Media Type
Device:		MIC2877:		2 MHz Synchronous Low Voltage Step-Up Regulator with 6.5A Switch and Bidirectional Load Disconnect				
Output Voltage:		4.75 = 4.75V						
		5.0 = 5.00V						
		5.25 = 5.25V						
		5.5 = 5.50V						
		A = Adjustable						
Temperature:		Y = -40°C to +85°C						
Package:		FT = 8-Lead FTQFN 2 x 2 mm						
Media Type:		TR = 5,000/Reel ⁽¹⁾						

Examples:

a) MIC2877-4.75YFT-TR: 4.75V Output Voltage, -40°C to +85°C Temp. Range, 8-Pin FTQFN, 5,000/Reel

b) MIC2877-5.0YFT-TR: 5V Output Voltage, -40°C to +85°C Temp. Range, 8-Pin FTQFN, 5,000/Reel

c) MIC2877-5.25YFT-TR: 5.25V Output Voltage, -40°C to +85°C Temp. Range, 8-Pin FTQFN, 5,000/Reel

d) MIC2877-5.5YFT-TR: 5.5V Output Voltage, -40°C to +85°C Temp. Range, 8-Pin FTQFN, 5,000/Reel

e) MIC2877-AYFT-TR: Adjustable Output Voltage, -40°C to +85°C Temp. Range, 8-Pin FTQFN, 5,000/Reel

Note 1: Tape and Reel identifier only appears in the catalog part number description. This identifier is used for ordering purposes and is not printed on the device package. Check with your Microchip Sales Office for package availability with the Tape and Reel option.

MIC2877

NOTES:

Note the following details of the code protection feature on Microchip devices:

- Microchip products meet the specification contained in their particular Microchip Data Sheet.
- Microchip believes that its family of products is one of the most secure families of its kind on the market today, when used in the intended manner and under normal conditions.
- There are dishonest and possibly illegal methods used to breach the code protection feature. All of these methods, to our knowledge, require using the Microchip products in a manner outside the operating specifications contained in Microchip's Data Sheets. Most likely, the person doing so is engaged in theft of intellectual property.
- Microchip is willing to work with the customer who is concerned about the integrity of their code.
- Neither Microchip nor any other semiconductor manufacturer can guarantee the security of their code. Code protection does not mean that we are guaranteeing the product as “unbreakable.”

Code protection is constantly evolving. We at Microchip are committed to continuously improving the code protection features of our products. Attempts to break Microchip's code protection feature may be a violation of the Digital Millennium Copyright Act. If such acts allow unauthorized access to your software or other copyrighted work, you may have a right to sue for relief under that Act.

Information contained in this publication regarding device applications and the like is provided only for your convenience and may be superseded by updates. It is your responsibility to ensure that your application meets with your specifications. MICROCHIP MAKES NO REPRESENTATIONS OR WARRANTIES OF ANY KIND WHETHER EXPRESS OR IMPLIED, WRITTEN OR ORAL, STATUTORY OR OTHERWISE, RELATED TO THE INFORMATION, INCLUDING BUT NOT LIMITED TO ITS CONDITION, QUALITY, PERFORMANCE, MERCHANTABILITY OR FITNESS FOR PURPOSE. Microchip disclaims all liability arising from this information and its use. Use of Microchip devices in life support and/or safety applications is entirely at the buyer's risk, and the buyer agrees to defend, indemnify and hold harmless Microchip from any and all damages, claims, suits, or expenses resulting from such use. No licenses are conveyed, implicitly or otherwise, under any Microchip intellectual property rights unless otherwise stated.

Microchip received ISO/TS-16949:2009 certification for its worldwide headquarters, design and wafer fabrication facilities in Chandler and Tempe, Arizona; Gresham, Oregon and design centers in California and India. The Company's quality system processes and procedures are for its PIC® MCUs and dsPIC® DSCs, KEELoC® code hopping devices, Serial EEPROMs, microperipherals, nonvolatile memory and analog products. In addition, Microchip's quality system for the design and manufacture of development systems is ISO 9001:2000 certified.

**QUALITY MANAGEMENT SYSTEM
CERTIFIED BY DNV
= ISO/TS 16949 =**

Trademarks

The Microchip name and logo, the Microchip logo, AnyRate, AVR, AVR logo, AVR Freaks, BeaconThings, BitCloud, CryptoMemory, CryptoRF, dsPIC, FlashFlex, flexPWR, Heldo, JukeBlox, KEELoC, KEELoC logo, Kleer, LANCheck, LINK MD, maXStylus, maXTouch, MediaLB, megaAVR, MOST, MOST logo, MPLAB, OptoLyzer, PIC, picoPower, PICSTART, PIC32 logo, Prochip Designer, QTouch, RightTouch, SAM-BA, SpyNIC, SST, SST Logo, SuperFlash, tinyAVR, UNI/O, and XMEGA are registered trademarks of Microchip Technology Incorporated in the U.S.A. and other countries.

ClockWorks, The Embedded Control Solutions Company, EtherSynch, Hyper Speed Control, HyperLight Load, IntelliMOS, mTouch, Precision Edge, and Quiet-Wire are registered trademarks of Microchip Technology Incorporated in the U.S.A.

Adjacent Key Suppression, AKS, Analog-for-the-Digital Age, Any Capacitor, AnyIn, AnyOut, BodyCom, chipKIT, chipKIT logo, CodeGuard, CryptoAuthentication, CryptoCompanion, CryptoController, dsPICDEM, dsPICDEM.net, Dynamic Average Matching, DAM, ECAN, EtherGREEN, In-Circuit Serial Programming, ICSP, Inter-Chip Connectivity, JitterBlocker, KleerNet, KleerNet logo, Mindi, MiWi, motorBench, MPASM, MPF, MPLAB Certified logo, MPLIB, MPLINK, MultiTRAK, NetDetach, Omniscient Code Generation, PICDEM, PICDEM.net, PICKit, PICTail, PureSilicon, QMatrix, RightTouch logo, REAL ICE, Ripple Blocker, SAM-ICE, Serial Quad I/O, SMART-I.S., SQI, SuperSwitcher, SuperSwitcher II, Total Endurance, TSHARC, USBCheck, VariSense, ViewSpan, WiperLock, Wireless DNA, and ZENA are trademarks of Microchip Technology Incorporated in the U.S.A. and other countries.

SQTP is a service mark of Microchip Technology Incorporated in the U.S.A.

Silicon Storage Technology is a registered trademark of Microchip Technology Inc. in other countries.

GestIC is a registered trademark of Microchip Technology Germany II GmbH & Co. KG, a subsidiary of Microchip Technology Inc., in other countries.

All other trademarks mentioned herein are property of their respective companies.

© 2017, Microchip Technology Incorporated, All Rights Reserved.
ISBN: 978-1-5224-2304-1