



Chipsmall Limited consists of a professional team with an average of over 10 year of expertise in the distribution of electronic components. Based in Hongkong, we have already established firm and mutual-benefit business relationships with customers from,Europe,America and south Asia,supplying obsolete and hard-to-find components to meet their specific needs.

With the principle of "Quality Parts,Customers Priority,Honest Operation,and Considerate Service",our business mainly focus on the distribution of electronic components. Line cards we deal with include Microchip,ALPS,ROHM,Xilinx,Pulse,ON,Everlight and Freescale. Main products comprise IC,Modules,Potentiometer,IC Socket,Relay,Connector.Our parts cover such applications as commercial,industrial, and automotives areas.

We are looking forward to setting up business relationship with you and hope to provide you with the best service and solution. Let us make a better world for our industry!



## Contact us

Tel: +86-755-8981 8866 Fax: +86-755-8427 6832

Email & Skype: info@chipsmall.com Web: www.chipsmall.com

Address: A1208, Overseas Decoration Building, #122 Zhenhua RD., Futian, Shenzhen, China





# MIC29302A

## 3A Fast-Response LDO Regulator

### General Description

The MIC29302A is a high-current, low-cost, low-dropout voltage regulator that uses Micrel's proprietary Super  $\beta$  PNP<sup>®</sup> process with a PNP pass element. The 3A LDO regulator features 450mV (full load) dropout voltage and very low ground current. Designed for high-current loads, these devices also find applications in lower current, low-dropout critical systems, where their dropout voltages and ground current values are important attributes.

Along with a total accuracy of  $\pm 2\%$  (over temperature, line, and load regulation) the regulator features very fast transient recovery from input voltage surges and output load current changes.

The MIC29302A has an adjustable output that can be set by two external resistors to a voltage between 1.24V and 15V. In addition, the device is fully protected against overcurrent faults, reversed input polarity, reversed lead insertion, and overtemperature operation. A TTL logic enable (EN) pin is available in the MIC29302A to shutdown the regulator. When not used, the device can be set to continuous operation by connecting EN to the input (IN). The MIC29302A is available in the standard and 5-pin TO-263 and TO-252 packages with an operating junction temperature range of  $-40^{\circ}\text{C}$  to  $+125^{\circ}\text{C}$ .

Datasheets and support documentation can be found on Micrel's website at: [www.micrel.com](http://www.micrel.com).

### Features

- High-current capability
  - 3A over full temperature range
- Low-dropout voltage of 450mV at full load
- Low ground current
- Accurate 1% guaranteed tolerance
- Extremely fast transient response
- Zero-current shutdown mode
- Error flag signals output out-of-regulation
- Adjustable output voltage
- Packages: TO-263-5L and TO-252-5L

### Applications

- Processor peripheral and I/O supplies
- High-efficiency "green" computer systems
- Automotive electronics
- High-efficiency linear lower supplies
- Battery-powered equipment
- PC add-in cards
- High-efficiency post-regulator for switching supply

### Typical Application

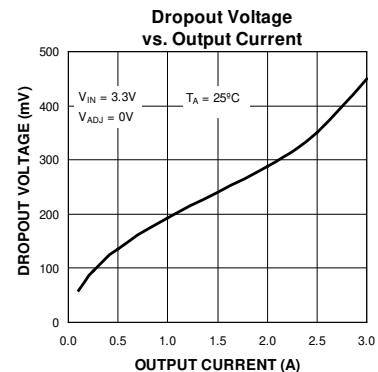
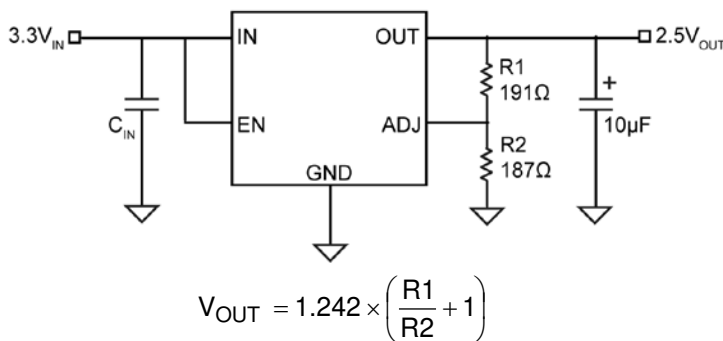

Super  $\beta$  PNP is a registered trademark of Micrel, Inc.

Micrel Inc. • 2180 Fortune Drive • San Jose, CA 95131 • USA • tel +1 (408) 944-0800 • fax + 1 (408) 474-1000 • <http://www.micrel.com>

## Ordering Information

Part Number	Voltage	Junction Temperature Range	Package
MIC29302AWU	Adjustable	-40°C to +125°C	5-Pin TO-263
MIC29302AWD	Adjustable	-40°C to +125°C	5-Pin TO-252

## Pin Configuration

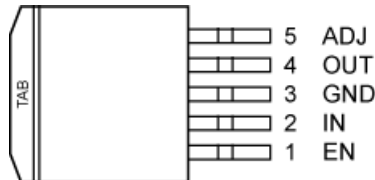

5-Pin TO-263 (D<sup>2</sup>Pak) Adjustable Voltage (U)  
MIC29302AWU

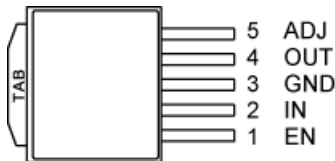

5-Pin TO-252 (D-Pak) Adjustable Voltage (D)  
MIC29302AWD

## Pin Description

Pin Number TO-263	Pin Number TO-252	Pin Name	Pin Function
1	1	EN	Enable (Input): Active-high CMOS compatible control input. Do not float.
2	2	IN	INPUT: Unregulated input, +3V to +16V maximum
3, TAB	3, TAB	GND	GND: TAB is also connected internally to the IC's ground on both packages.
4	4	OUT	OUTPUT: The regulator output voltage
5	5	ADJ	Feedback Voltage: 1.24V feedback from external resistor divider.

**Absolute Maximum Ratings<sup>(1)</sup>**

Input Supply Voltage ( $V_{IN}$ ) <sup>(1)</sup> .....	-20V to +20V
Enable Input Voltage ( $V_{EN}$ ).....	-0.3V to $V_{IN}$
Lead Temperature (soldering, 5 sec.).....	260°C
Power Dissipation .....	Internally Limited
Storage Temperature Range .....	-65°C to +150°C
ESD Rating all pins <sup>(3)</sup>	

**Operating Ratings<sup>(2)</sup>**

Operating Junction Temperature .....	-40°C to +125°C
Operating Input Voltage .....	3V to 16V
Package Thermal Resistance	
TO-263 ( $\theta_{JC}$ ).....	3°C/W
TO-252 ( $\theta_{JC}$ ).....	3°C/W
TO-252 ( $\theta_{JA}$ ) .....	35°C/W
TO-263 ( $\theta_{JA}$ ).....	28°C/W

**Electrical Characteristics<sup>(4)</sup>**

$V_{IN} = 4.2V$ ;  $I_{OUT} = 100mA$ ;  $T_A = 25^\circ C$ , **bold** values indicate  $-40^\circ C \leq T_J \leq +125^\circ C$ , unless noted.

Parameter	Condition	Min.	Typ.	Max.	Units
<b>Output Voltage</b>					
Output Voltage Accuracy <sup>(5)</sup>	$100mA \leq I_{OUT} \leq 3A$ , $(V_{OUT} + 1V) \leq V_{IN} \leq 16V$	<b>-2</b>		<b>2</b>	%
Line Regulation	$I_{OUT} = 100mA$ , $(V_{OUT} + 1V) \leq V_{IN} \leq 16V$		0.1	0.5	%
Load Regulation	$V_{IN} = V_{OUT} + 1V$ , $100mA \leq I_{OUT} \leq 3A$		0.2	1	%
Dropout Voltage <sup>(6)</sup>	$I_{OUT} = 100mA$		80	<b>200</b>	mV
	$I_{OUT} = 750mA$		220		
	$I_{OUT} = 1.5A$		275		
	$I_{OUT} = 2.0A$		375	<b>630</b>	
	$I_{OUT} = 2.5A$		430	<b>720</b>	
	$I_{OUT} = 3A$		450	<b>800</b>	
<b>Ground Current</b>					
Ground Current	$I_{OUT} = 750mA$ , $V_{IN} = V_{OUT} + 1V$		5	<b>20</b>	mA
	$I_{OUT} = 1.5A$		15		
	$I_{OUT} = 3A$		60	<b>150</b>	
$I_{GRNDDO}$ Ground Pin Current @ Dropout	$V_{IN} = 0.5V$ less than specified $V_{OUT} \times I_{OUT} = 10mA$		2		
Current Limit	$V_{OUT} = 0V$ <sup>(7)</sup>	3	4		A
$e_n$ , Output Noise Voltage (10Hz to 100kHz)	$C_L = 10\mu F$		400		$\mu V_{RMS}$
	$C_L = 33\mu F$		260		
Ground Pin Current in Shutdown	Input Voltage $V_{IN} = 16V$		32		$\mu A$

**Notes:**

- Exceeding the absolute maximum rating may damage the device.
- The device is not guaranteed to function outside its operating rating.
- Devices are ESD sensitive. Handling precautions recommended. Human body model, 1.5k $\Omega$  in series with 100pF.
- Specification for packaged product only
- Output voltage temperature coefficient is defined as the worst case voltage change divided by the total temperature change.
- Dropout voltage is defined as the input-to-output differential when output voltage drops to 99% of its normal value with  $V_{OUT} + 1V$  applied to  $V_{IN}$ .
- $V_{IN} = V_{OUT (nominal)} + 1V$ . For example, use  $V_{IN} = 4.3V$  for a 3.3V regulator or use 6V for a 5V regulator. Employ pulse testing procedure for current limit.

## Electrical Characteristics<sup>(4)</sup> (Continued)

$V_{IN} = 4.2V$ ;  $I_{OUT} = 10mA$ ;  $T_A = 25^{\circ}C$ , **bold** values indicate  $-40^{\circ}C \leq T_J \leq +125^{\circ}C$ , unless noted.

<b>Reference</b>					
Reference Voltage	Note 8	<b>1.215</b>		<b>1.267</b>	V
Adjust Pin Bias Current			40		nA
				<b>120</b>	
<b>ENABLE Input</b>					
Input Logic Voltage	Low (OFF)			<b>0.8</b>	V
	High (ON)	<b>2.4</b>			
Enable Pin Input Current	$V_{EN} = 4.2V$		15	30	$\mu A$
				<b>75</b>	
	$V_{EN} = 0.8V$			2	
Regulator Output Current in Shutdown	Note 10		10		$\mu A$
				<b>20</b>	

### Notes:

- $V_{REF} \leq V_{OUT} \leq V_{IN} - 1$ ,  $3V \leq V_{OUT} \leq 16V$ ,  $10mA \leq I_L \leq I_{FL}$ ,  $T_J \leq T_{Jmax}$ .
- Thermal regulation is defined as the change in the output voltage at a time T after a change in power dissipation is applied, excluding load or line regulation effects. Specifications are for a 250mA load pulse at  $V_{IN} = 16V$  (a 4W pulse) for  $T = 10ms$ .
- $V_{EN} \leq 0.8V$ ,  $V_{IN} \leq 16V$  and  $V_{OUT} = 0V$ .

## Typical Characteristics

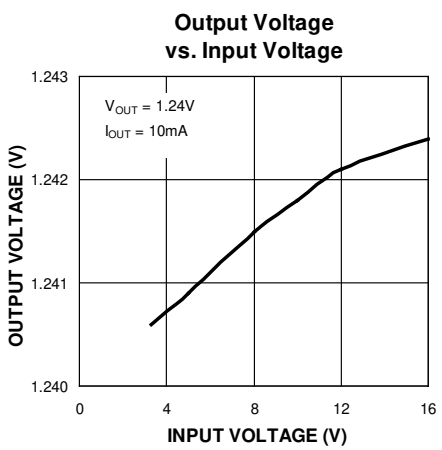
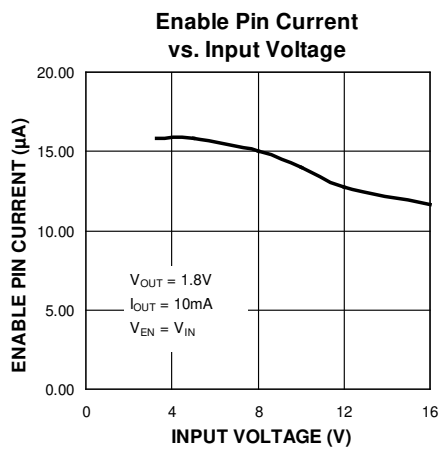
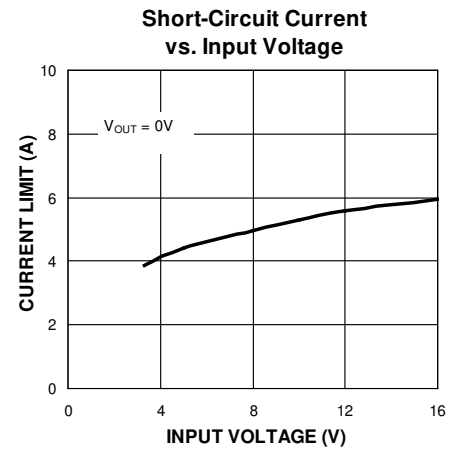
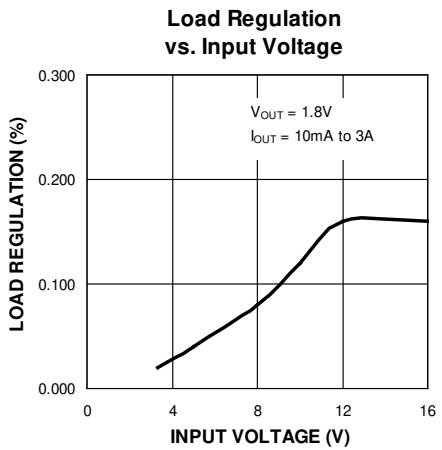
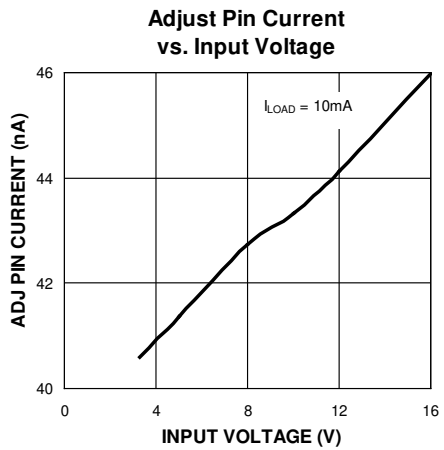
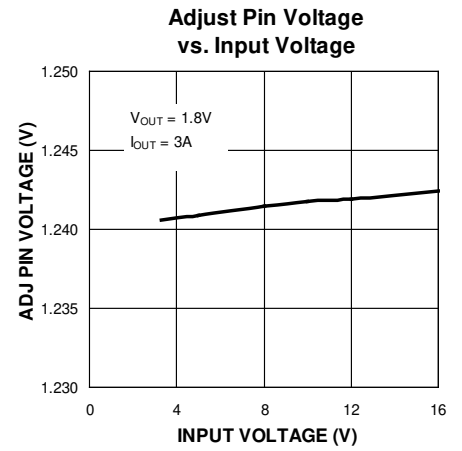
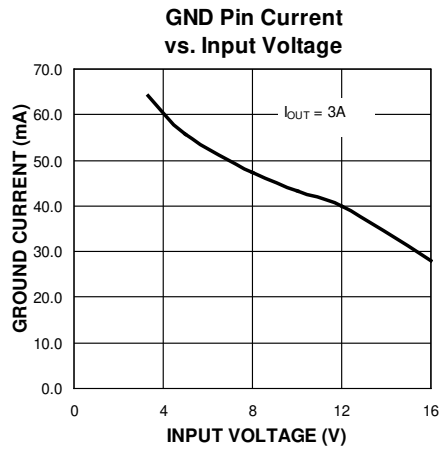
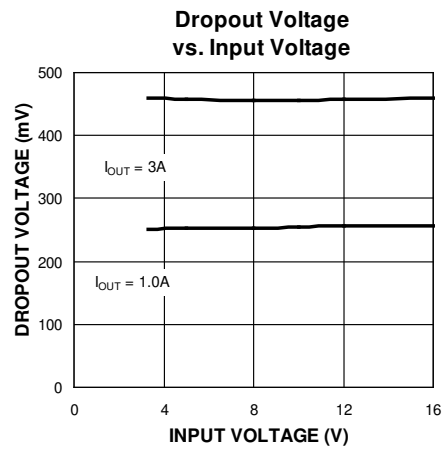

## Typical Characteristics (Continued)

**GND Pin Current vs. Temperature**

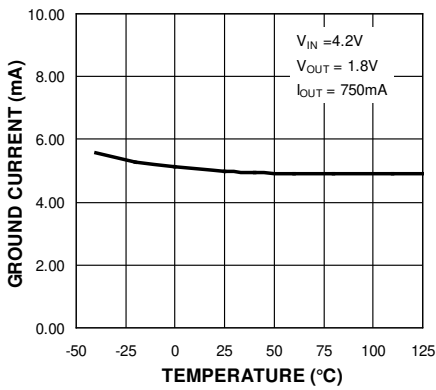

**Enable Bias Current vs. Temperature**

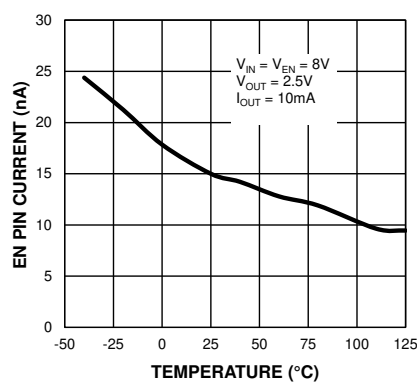

**Dropout Voltage vs. Temperature**

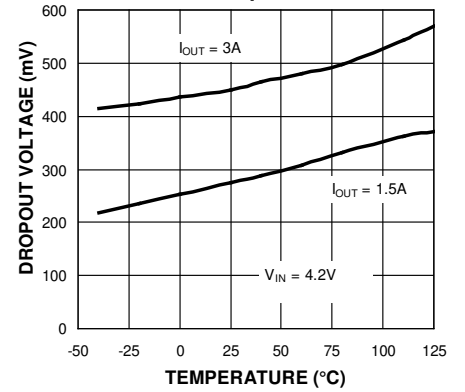

**Dropout Voltage vs. Temperature**

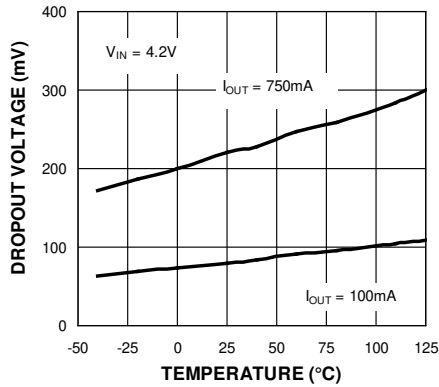

**Short-Circuit Current vs. Temperature**

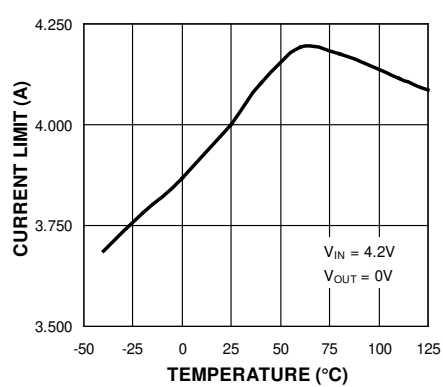

**Adjust Pin Voltage vs. Temperature**

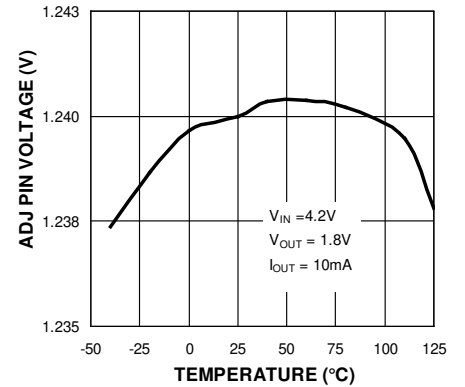

**Adjust Pin Current vs. Temperature**

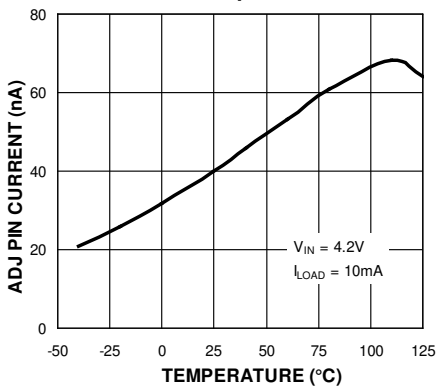

**Line Regulation vs. Temperature**

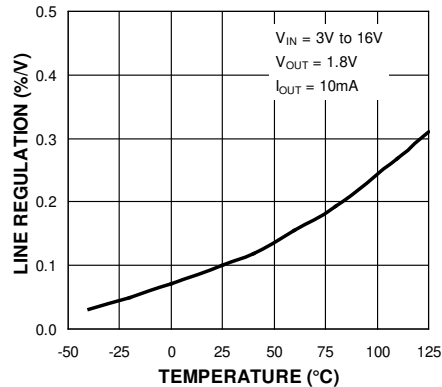

### Typical Characteristics (Continued)

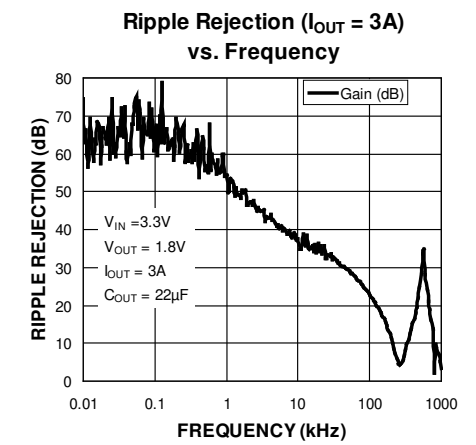
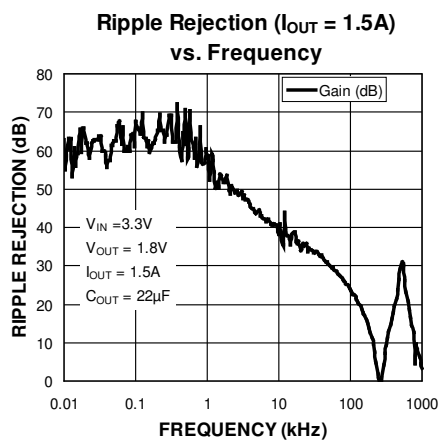
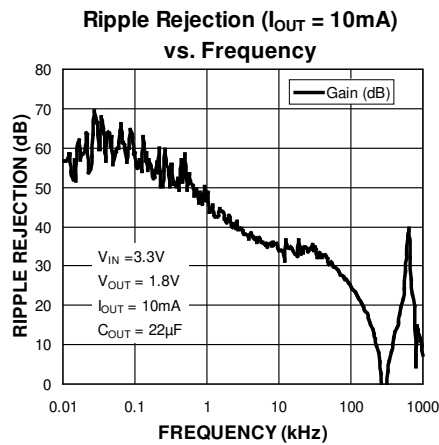
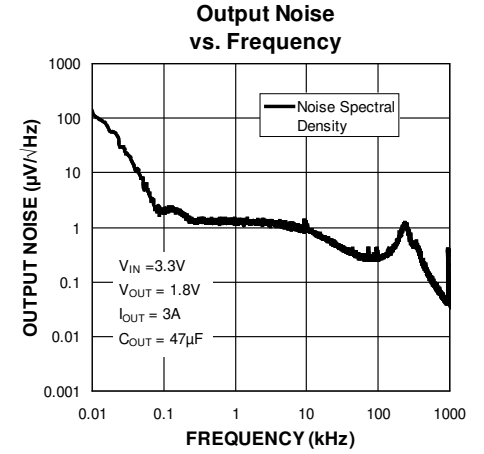
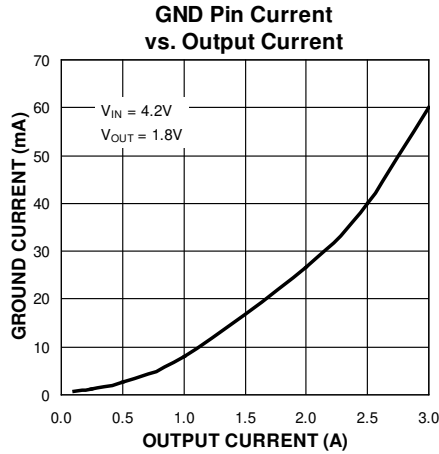
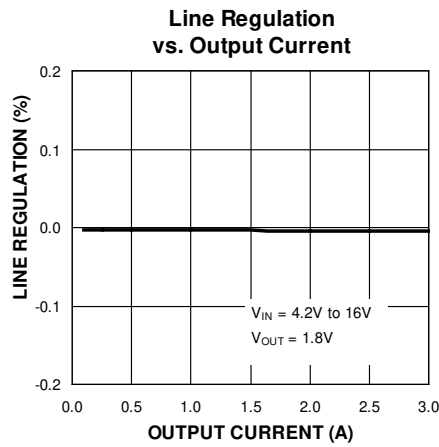
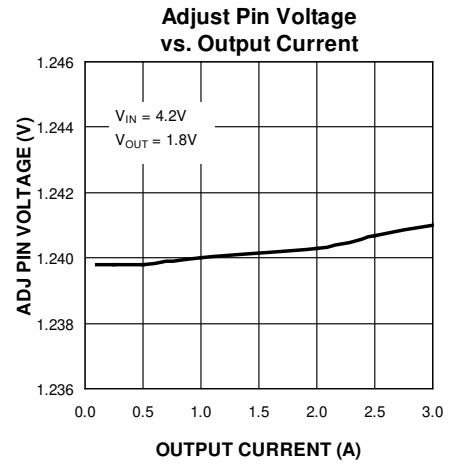
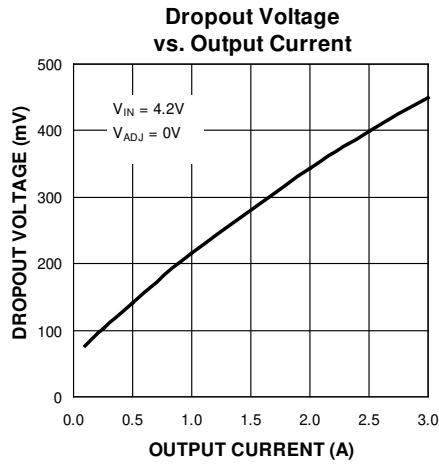
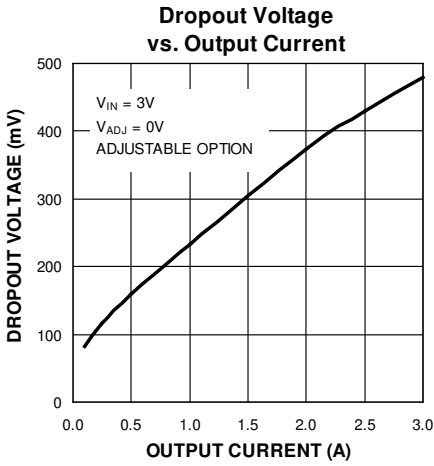



# Functional Characteristics

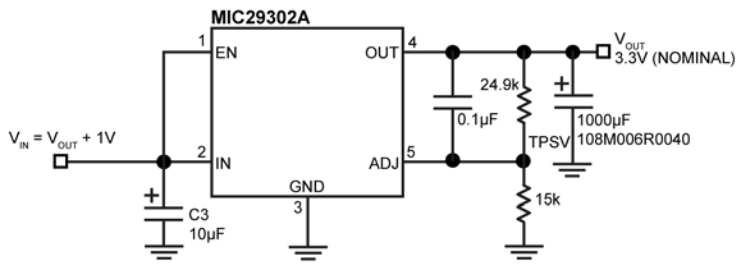
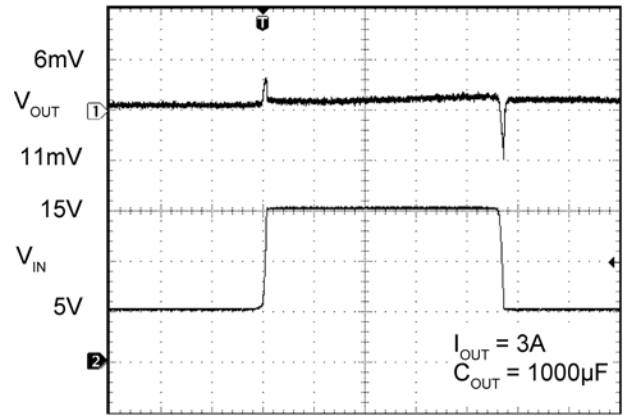

Figure 1. MIC29302A Load Transient Response Test Circuit

MIC29302A Line Transient Response with 3A Load, 1000µF Output Capacitance



Time (1.00ms/div)

MIC29302A Load Transient Response with 3A Load, 1000µF Output Capacitance

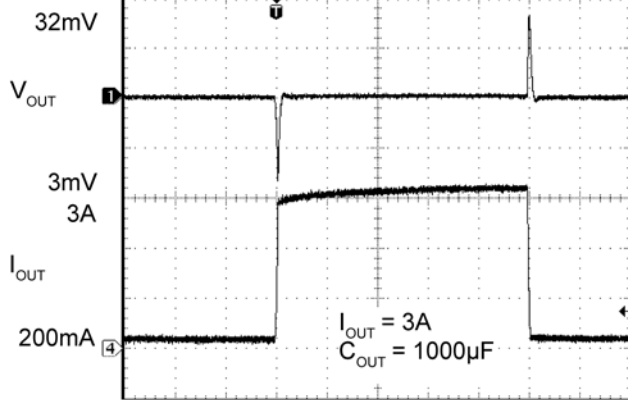

Time (1.00ms/div)

MIC29302A Line Transient Response with 3A Load, 10µF Output Capacitance

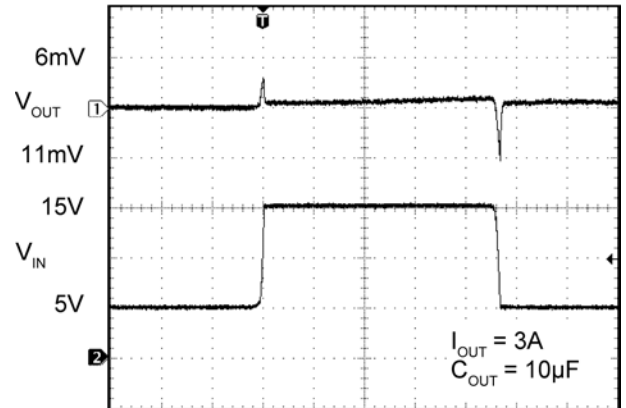

Time (1.00ms/div)

### Functional Diagram

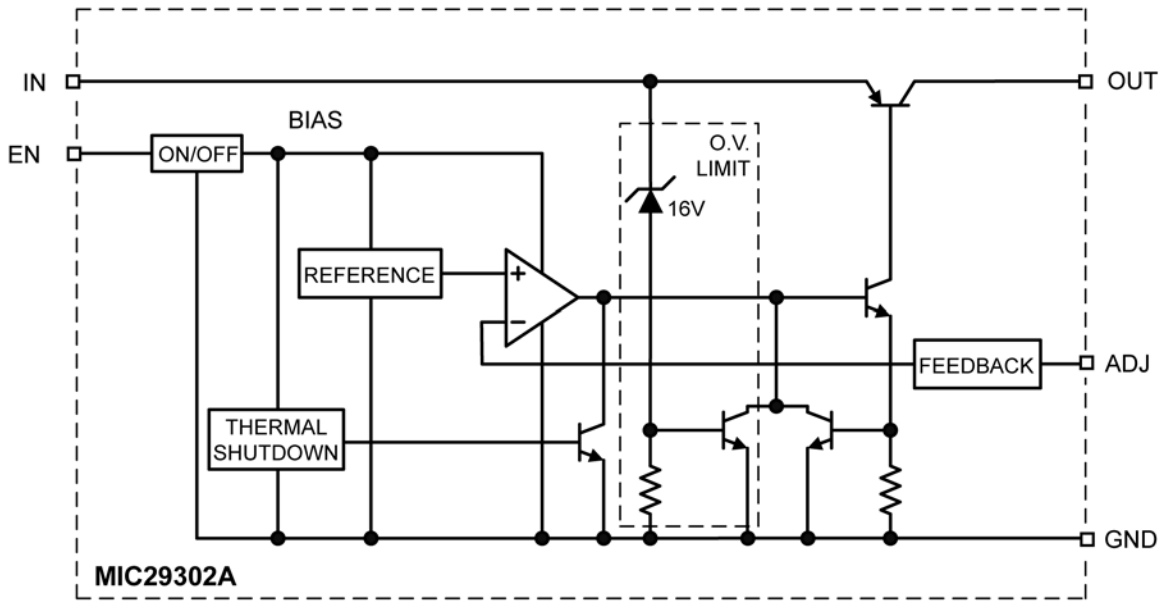

## Application Information

The MIC29302A is a high-performance, low-dropout voltage regulator suitable for all moderate to high-current voltage regulation applications. Its 450mV typical dropout voltage at full load makes it especially valuable in battery-powered systems and as high efficiency noise filters in post-regulator applications. Unlike older NPN-pass transistor designs, where the minimum dropout voltage is limited by the base-emitter voltage drop and collector-emitter saturation voltage, dropout performance of the PNP output is limited merely by the low  $V_{CE}$  saturation voltage.

A trade-off for the low-dropout voltage is a varying base driver requirement. But Micrel's Super Beta PNP<sup>®</sup> process reduces this drive requirement to merely 1% of the load current.

The MIC29302A regulator is fully protected from damage due to fault conditions. Current limiting is linear; output current under overload conditions is constant. Thermal shutdown disables the device when the die temperature exceeds the +125°C maximum safe operating temperature. The output structure of the regulators allows voltages in excess of the desired output voltage to be applied without reverse current flow. The MIC29302A offers a logic-level ON/OFF control. When disabled, the device draws nearly zero current.

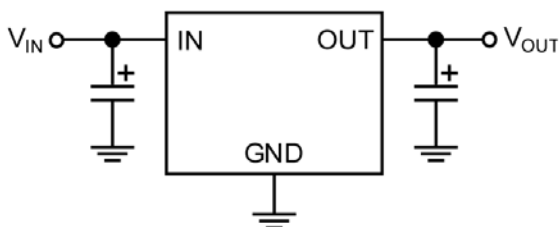

**Figure 2. Linear Regulators Require Only Two Capacitors for Operation**

### Thermal Design

Linear regulators are simple to use. The most complicated set of design parameters to consider are thermal characteristics. Thermal design requires the following application-specific parameters:

- Maximum ambient temperature,  $T_A$
- Output Current,  $I_{OUT}$
- Output Voltage,  $V_{OUT}$
- Input Voltage,  $V_{IN}$

First, we calculate the power dissipation of the regulator from these numbers and the device parameters from this datasheet:

$$P_D = I_{OUT}(1.02V_{IN} - V_{OUT})$$

Where the ground current is approximated by 2% of  $I_{OUT}$ . Then the heatsink thermal resistance is determined with this formula:

$$\theta_{SA} = \frac{T_{JMAX} - T_A}{P_D} - (\theta_{JC} + \theta_{CS})$$

where:

$$T_{JMAX} \leq 125^\circ\text{C} \text{ and } \theta_{CS} \text{ is between } 0^\circ\text{C/W} \text{ and } 2^\circ\text{C/W}.$$

The heatsink may be significantly reduced in applications where the minimum input voltage is known and is large compared to the dropout voltage. A series input resistor can be used to drop excessive voltage and distribute the heat between this resistor and the regulator. The low-dropout properties of Micrel Super Beta PNP<sup>®</sup> regulators allow very significant reductions in regulator power dissipation and the associated heatsink without compromising performance. When this technique is employed, a capacitor of at least 0.1 $\mu$ F is needed directly between the input and regulator ground.

Please refer to *Application Note 9* and *Application Hint 17* on Micrel's website ([www.micrel.com](http://www.micrel.com)) for further details and examples on thermal design and heatsink specification.

With no heatsink in the application, calculate the junction temperature to determine the maximum power dissipation that will be allowed before exceeding the maximum junction temperature of the MIC29302A. The maximum power allowed can be calculated using the thermal resistance ( $\theta_{JA}$ ) of the D-Pak (TO252) adhering to the following criteria for the PCB design: 2oz. copper and 100mm<sup>2</sup> copper area for the MIC29302A.

For example, given an expected maximum ambient temperature ( $T_A$ ) of 75°C with  $V_{IN} = 3.3\text{V}$ ,  $V_{OUT} = 2.5\text{V}$ , and  $I_{OUT} = 3\text{A}$ , first calculate the expected  $P_D$  using:

$$P_D = (3.3\text{V} - 2.5\text{V}) \times 3\text{A} - (3.3\text{V}) \times (0.016\text{A}) = 2.3472\text{W}$$

Next, calculate the junction temperature for the expected power dissipation:

$$T_J = (\theta_{JA} \times P_D) + T_A = (35^\circ\text{C/W} \times 2.3472\text{W}) + 75^\circ\text{C} = 157.15^\circ\text{C}$$

Now determine the maximum power dissipation allowed that would not exceed the IC's maximum junction temperature (125°C) without the use of a heatsink by:

$$\begin{aligned} P_{D(\text{MAX})} &= (T_{J(\text{MAX})} - T_A) / \theta_{JA} \\ &= (125^\circ\text{C} - 75^\circ\text{C}) / (35^\circ\text{C/W}) \\ &= 1.428\text{W} \end{aligned}$$

### Capacitor Requirements

For stability and minimum output noise, a capacitor on the regulator output is necessary. The value of this capacitor is dependent upon the output current; lower currents allow smaller capacitors. The MIC29302A is stable with a 10µF capacitor at full load.

This capacitor need not be an expensive low-ESR type; aluminum electrolytics are adequate. In fact, extremely low-ESR capacitors may contribute to instability. Tantalum capacitors are recommended for systems where fast load transient response is important.

When the regulator is powered from a source with high AC impedance, a 0.1µF capacitor connected between input and GND is recommended.

### Transient Response and 5V to 3.3V Conversion

The MIC29302A has excellent response to variations in input voltage and load current. By virtue of its low dropout voltage, the device does not saturate into dropout as readily as similar NPN-based designs. A 3.3V output Micrel LDO will maintain full speed and performance with an input supply as low as 4.2V, and will still provide some regulation with supplies down to 3.8V, unlike NPN devices that require 5.1V or more for good performance and become nothing more than a resistor under 4.6V of input. Micrel's PNP regulators provide superior performance in "5V to 3.3V" conversion applications than NPN regulators, especially when all tolerances are considered.

### Minimum Load Current

The MIC29302A regulator operates within a specified load range. If the output current is too small, leakage currents dominate and the output voltage rises.

A minimum load current of 10mA is necessary for proper regulation and to swamp any expected leakage current across the operating temperature range.

For best performance the total resistance (R1+R2) should be small enough to pass the minimum regulator load current of 10mA.

### Adjustable Regulator Design

The output voltage can be programmed anywhere between 1.25V and the 15V. Two resistors are used. The resistor values are calculated by:

$$R_1 = R_2 \times \left( \frac{V_{\text{OUT}}}{1.240} - 1 \right)$$

where  $V_{\text{OUT}}$  is the desired output voltage.

Figure 3 shows component definition. Applications with widely varying load currents may scale the resistors to draw the minimum load current required for proper operation (see "Minimum Load Current" section).

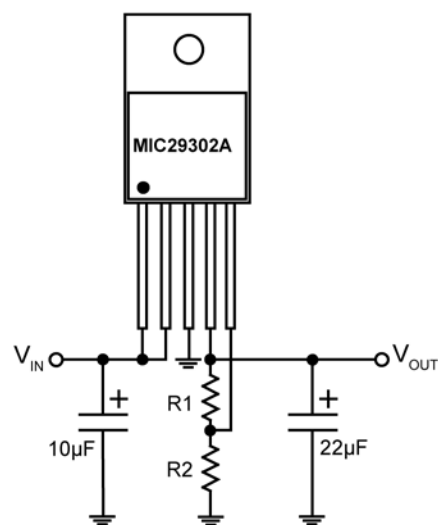
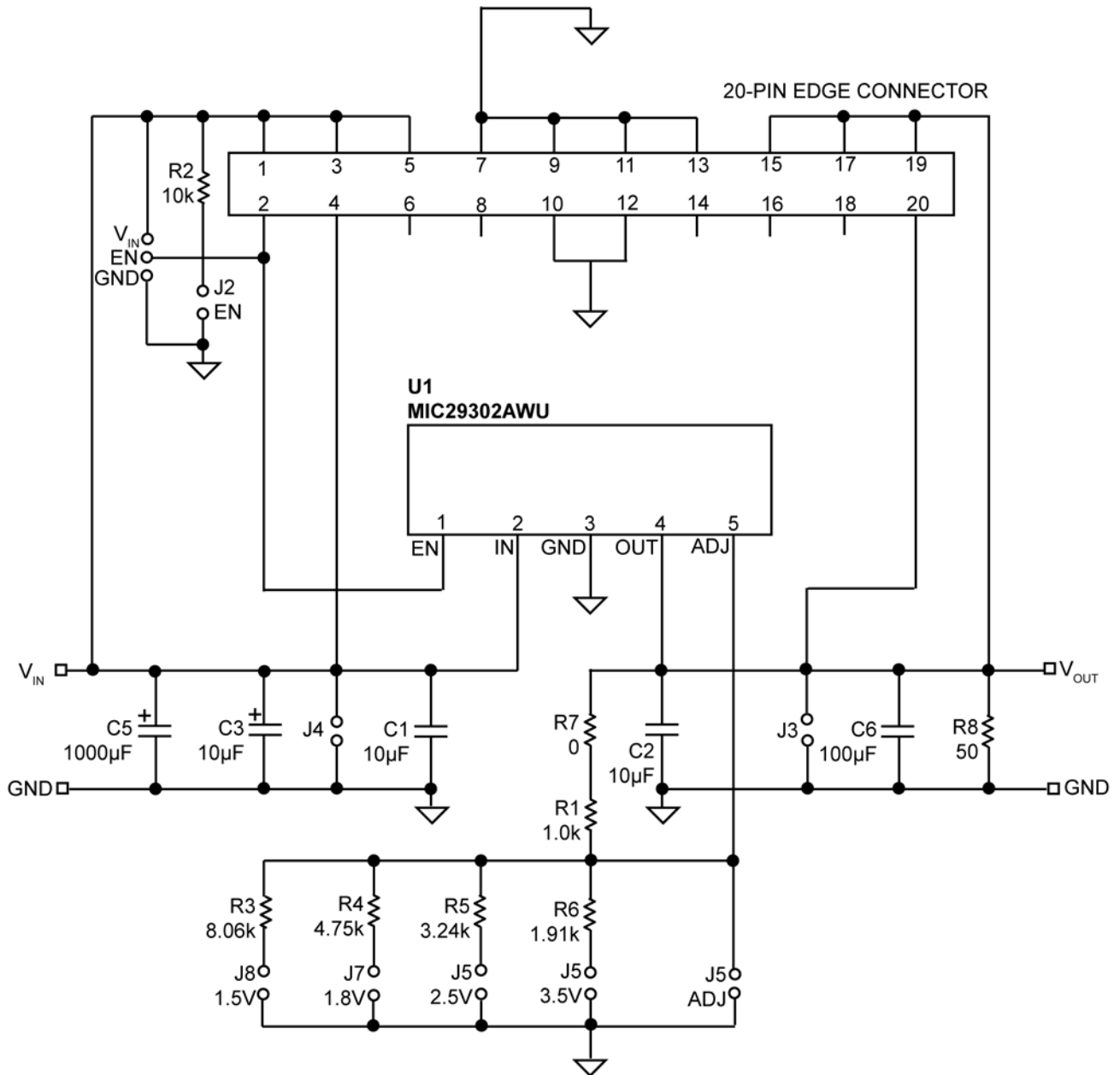

Figure 3. Adjustable Regulator with Resistors

### Enable Input

MIC29302A features an enable (EN) input that allows ON/OFF control of the device. Special design allows "zero" current drain when the device is disabled—only microamperes of leakage current flows. The EN input has TTL/CMOS compatible thresholds for simple interfacing with logic, or may be directly tied to  $V_{\text{IN}}$ . Enabling the regulator requires approximately 20µA of current into the EN pin.

### Evaluation Board Schematic



**Bill of Materials**

Item	Part Number	Manufacturer	Description	Qty.
C1	C2012X5R1E106K	TDK <sup>(11)</sup>	10 $\mu$ F, 25V, Ceramic Capacitor, X5R, 0805	1
C2,C3	B45196H4106K309	Kemet <sup>(12)</sup>	10 $\mu$ F, 20V, Tantalum Capacitor, 2312	2
	TR3C106K020C0450	Vishay <sup>(13)</sup>		
C5	EEU-FM1E102	Panasonic <sup>(14)</sup>	1000 $\mu$ F, 25V, Elect Capacitor, through hole, 10X22-case	1
C6	T495D107K016ATE125	Kemet	100 $\mu$ F, 20V, Tantalum Capacitor, 2917	1
	TR3D107K016C0125	Vishay		
R1	CRCW06031K00FKTA	Vishay	1k, Resistor, 1%, 0603	1
R2	Open (CRCW06031002FRT1)	Vishay	10k, Resistor, 1%, 0603	1
R3	CRCW06038061FRT1	Vishay	8.06k, Resistor, 1%, 0603	1
R4	CRCW06034751FRT1	Vishay	4.75k, Resistor, 1%, 0603	1
R5	CRCW06033241FRT1	Vishay	3.24k, Resistor, 1%, 0603	1
R6	CRCW06031911RFRT1	Vishay	1.91k, Resistor, 1%, 0603	1
R7	CRCW06030000FKTA	Vishay	0 $\Omega$ , Resistor, 1%, 0603	1
R8	CRCW060350R0FRT1	Vishay	50 $\Omega$ , Resistor, 1%, 0603	1
U1	<b>MIC29302AWU</b>	<b>Micrel<sup>(15)</sup></b>	<b>3A Fast-Response LDO Regulator</b>	1

**Notes:**

11. TDK: [www.tdk.com](http://www.tdk.com).
12. Kemet: [www.kemet.com](http://www.kemet.com).
13. Vishay: [www.vishay.com](http://www.vishay.com).
14. Panasonic.: [www.panasonic.com](http://www.panasonic.com).
15. **Micrel, Inc.:** [www.micrel.com](http://www.micrel.com).

# PCB Layout Recommendations

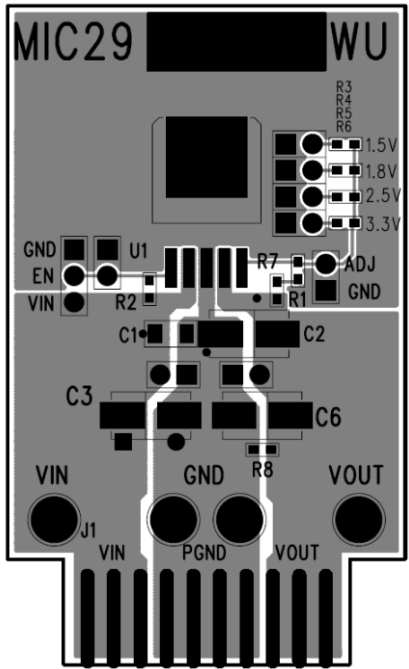

MIC29302A Evaluation Board Top Layer

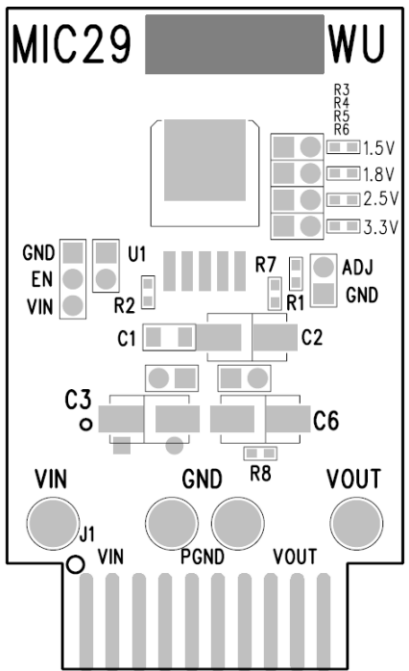

MIC29302A Evaluation Board Top Silk

### PCB Layout Recommendations (Continued)

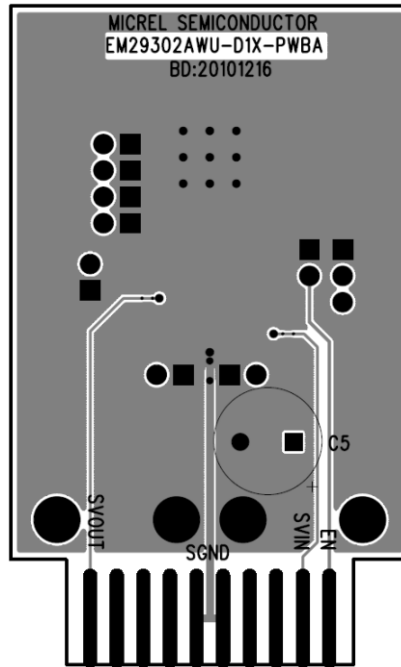

MIC29302A Evaluation Board Bottom Layer

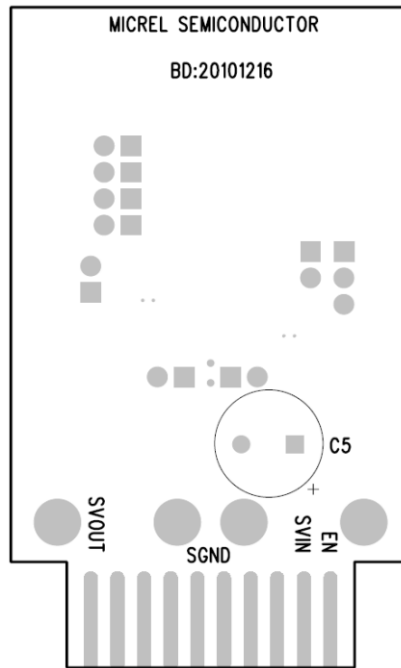

MIC29302A Evaluation Board Bottom Silk



Package Information<sup>(16)</sup>

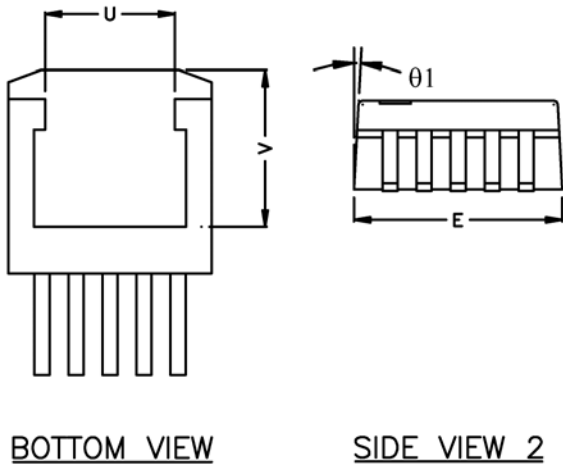
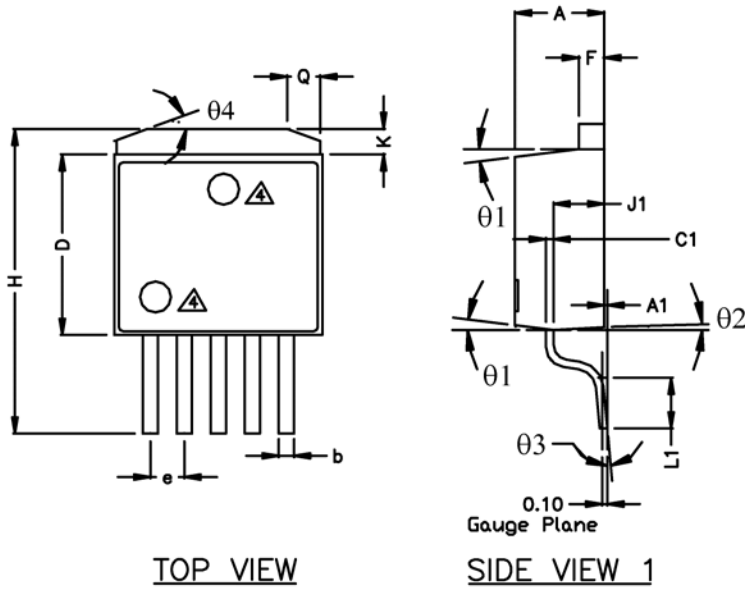

PDS	INCH		MM	
	MIN	MAX	MIN	MAX
A	0.170	0.181	4.318	4.597
A1	0.000	0.012	0.000	0.305
b	0.026	0.036	0.660	0.914
C1	0.012	0.023	0.305	0.584
D	0.330	0.361	8.392	9.169
E	0.396	0.420	10.058	10.668
e	0.062	0.072	1.575	1.829
F	0.045	0.055	1.143	1.397
H	0.575	0.625	14.605	15.875
J1	0.080	0.120	2.032	3.048
K	0.045	0.066	1.143	1.676
L1	0.090	0.110	2.286	2.794
theta1	3°	10°	3°	10°
theta2	1°	7°	1°	7°
theta3	0°	8°	0°	8°
theta4	18°	22°	18°	22°
Q	0.055	0.075	1.397	1.905
U	0.256	Ref.	6.502	Ref.
V	0.305	Ref.	7.747	Ref.

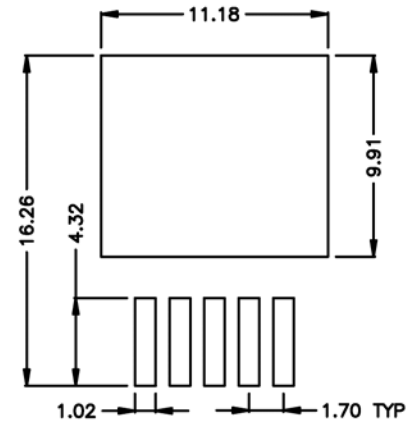

- NOTE:
1. PACKAGE OUTLINE EXCLUSIVE OF MOLD FLASH & METAL BURR.
  2. PACKAGE OUTLINE INCLUSIVE OF PLATING THICKNESS.
  3. FOOT LENGTH USING GAUGE PLANE METHOD MEASUREMENT 0.010"
  4. PACKAGE TOP MARK MAY BE IN TOP CENTER OR LOWER LEFT CORNER
  5. ALL DIMENSIONS ARE IN INCHES/MILLIMETERS.

RECOMMENDED LAND PATTERN  
(UNIT : mm)

5-Pin TO-263 (U)

Note:

16. Package information is correct as of the publication date. For updates and most current information, go to [www.micrel.com](http://www.micrel.com).

Package Information (Continued)

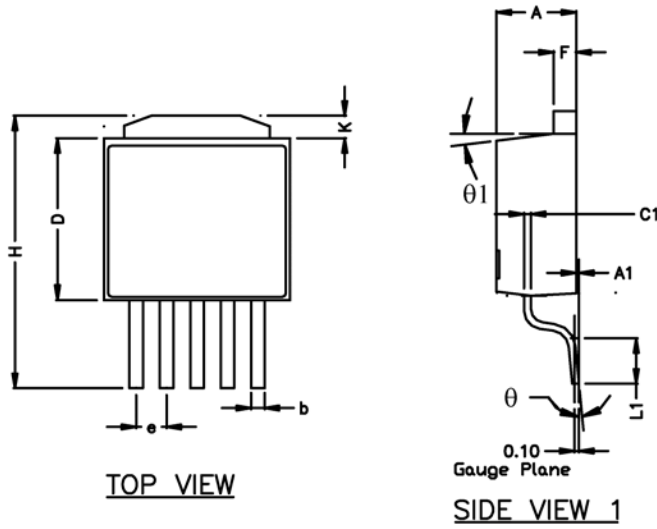

PDS	INCH		MM	
	MIN	MAX	MIN	MAX
A	0.087	0.094	2.210	2.387
A1	0.000	0.012	0.000	0.305
b	0.023	0.026	0.584	0.660
C1	0.012	0.023	0.305	0.584
D	0.236	0.241	6.000	6.200
E	0.252	0.260	6.400	6.604
e	0.045	0.055	1.143	1.397
F	0.019	0.023	0.483	0.584
H	0.378	0.402	9.601	10.210
K	0.039	0.047	1.000	1.200
L1	0.055	0.065	1.397	1.651
θ	0°	8°	0°	8°
θ1	3°	10°	3°	10°
Q	0.055	0.075	1.397	1.905
U	0.206	Ref.	5.232	Ref.
V	0.213	Ref.	5.415	Ref.

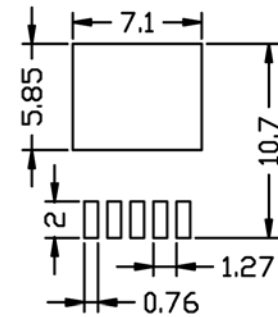
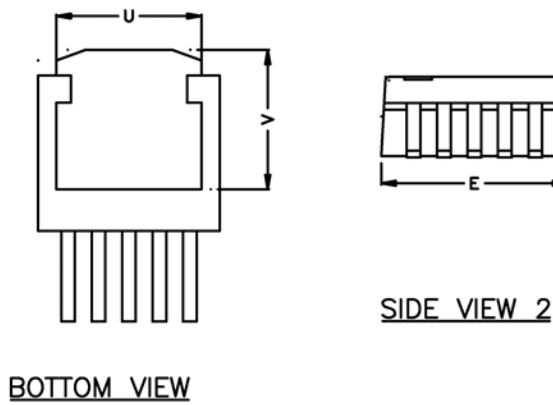

NOTE: unit in mm

- NOTE:
1. PACKAGE OUTLINE EXCLUSIVE OF MOLD FLASH & METAL BURR.
  2. PACKAGE OUTLINE INCLUSIVE OF PLATING THICKNESS.
  3. FOOT LENGTH USING GAUGE PLANE METHOD MEASUREMENT 0.010"
  4. ALL DIMENSIONS ARE IN INCHES/MILLIMETERS.

5-Pin TO-252 (D)

---

**MICREL, INC. 2180 FORTUNE DRIVE SAN JOSE, CA 95131 USA**  
TEL +1 (408) 944-0800 FAX +1 (408) 474-1000 WEB <http://www.micrel.com>

Micrel, Inc. is a leading global manufacturer of IC solutions for the worldwide high performance linear and power, LAN, and timing & communications markets. The Company's products include advanced mixed-signal, analog & power semiconductors; high-performance communication, clock management, MEMs-based clock oscillators & crystal-less clock generators, Ethernet switches, and physical layer transceiver ICs. Company customers include leading manufacturers of enterprise, consumer, industrial, mobile, telecommunications, automotive, and computer products. Corporation headquarters and state-of-the-art wafer fabrication facilities are located in San Jose, CA, with regional sales and support offices and advanced technology design centers situated throughout the Americas, Europe, and Asia. Additionally, the Company maintains an extensive network of distributors and reps worldwide.

Micrel makes no representations or warranties with respect to the accuracy or completeness of the information furnished in this datasheet. This information is not intended as a warranty and Micrel does not assume responsibility for its use. Micrel reserves the right to change circuitry, specifications and descriptions at any time without notice. No license, whether express, implied, arising by estoppel or otherwise, to any intellectual property rights is granted by this document. Except as provided in Micrel's terms and conditions of sale for such products, Micrel assumes no liability whatsoever, and Micrel disclaims any express or implied warranty relating to the sale and/or use of Micrel products including liability or warranties relating to fitness for a particular purpose, merchantability, or infringement of any patent, copyright, or other intellectual property right.

Micrel Products are not designed or authorized for use as components in life support appliances, devices or systems where malfunction of a product can reasonably be expected to result in personal injury. Life support devices or systems are devices or systems that (a) are intended for surgical implant into the body or (b) support or sustain life, and whose failure to perform can be reasonably expected to result in a significant injury to the user. A Purchaser's use or sale of Micrel Products for use in life support appliances, devices or systems is a Purchaser's own risk and Purchaser agrees to fully indemnify Micrel for any damages resulting from such use or sale.

© 2011 Micrel, Incorporated.