



Chipsmall Limited consists of a professional team with an average of over 10 year of expertise in the distribution of electronic components. Based in Hongkong, we have already established firm and mutual-benefit business relationships with customers from,Europe,America and south Asia,supplying obsolete and hard-to-find components to meet their specific needs.

With the principle of “Quality Parts,Customers Priority,Honest Operation,and Considerate Service”,our business mainly focus on the distribution of electronic components. Line cards we deal with include Microchip,ALPS,ROHM,Xilinx,Pulse,ON,Everlight and Freescale. Main products comprise IC,Modules,Potentiometer,IC Socket,Relay,Connector.Our parts cover such applications as commercial,industrial, and automotives areas.

We are looking forward to setting up business relationship with you and hope to provide you with the best service and solution. Let us make a better world for our industry!



Contact us

Tel: +86-755-8981 8866 Fax: +86-755-8427 6832

Email & Skype: info@chipsmall.com Web: www.chipsmall.com

Address: A1208, Overseas Decoration Building, #122 Zhenhua RD., Futian, Shenzhen, China





MIC39100/1/2

1A, Low-Voltage, Low-Dropout Regulator

General Description

The MIC39100, MIC39101, and MIC39102 are 1A low-dropout linear voltage regulators that provide low-voltage, high-current output from an extremely small package. Utilizing Micrel's proprietary Super β PNP[®] pass element, the MIC39100/1/2 offers extremely low dropout (typically 410mV at 1A) and low ground current (typically 11mA at 1A).

The MIC39100 is a fixed output regulator offered in the SOT-223 package. The MIC39101 and MIC39102 are fixed and adjustable regulators, respectively, in a thermally enhanced power 8-lead SOIC package.

The MIC39100/1/2 is ideal for PC add-in cards that need to convert from standard 5V to 3.3V, 3.3V to 2.5V or 2.5V to 1.8V. A guaranteed maximum dropout voltage of 630mV over all operating conditions allows the MIC39100/1/2 to provide 2.5V from a supply as low as 3.13V and 1.8V from a supply as low as 2.43V.

The MIC39100/1/2 is fully protected with overcurrent limiting, thermal-shutdown, and reverse-battery protection. Fixed voltages of 5.0V, 3.3V, 2.5V, and 1.8V are available on MIC39100/1 with adjustable output voltages to 1.24V on MIC39102.

Datasheets and support documentation are available on Micrel's web site at: www.micrel.com.

Features

- Fixed and adjustable output voltages to 1.24V
- 410mV typical dropout at 1A
 - Ideal for 3.0V to 2.5V conversion
 - Ideal for 2.5V to 1.8V conversion
- 1A minimum guaranteed output current
- 1% initial accuracy
- Low ground current
- Current-limiting and thermal-shutdown protection
- Reversed-battery and reversed-leakage protection
- Fast transient response
- Low-profile SOT-223 package
- Power SO-8 package

Applications

- LDO linear regulator for PC add-in cards
- High-efficiency linear power supplies
- SMPS post regulator
- Multimedia and PC processor supplies
- Battery chargers
- Low-voltage microcontrollers and digital logic

Typical Applications

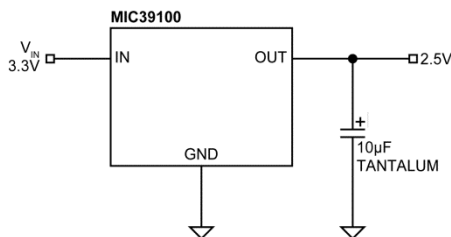

2.5V/1A Regulator

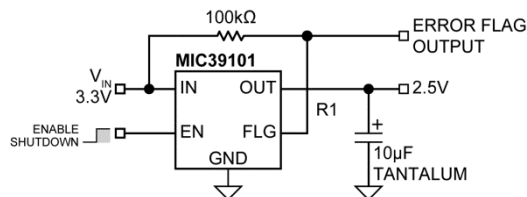

2.5V/1A Regulator with Error Flag

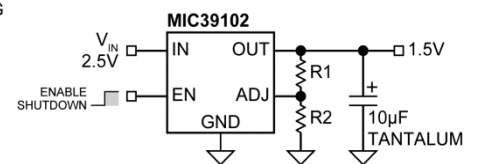

1.5V/1A Adjustable Regulator

Super β PNP is a registered trademark of Micrel, Inc.

Micrel Inc. • 2180 Fortune Drive • San Jose, CA 95131 • USA • tel +1 (408) 944-0800 • fax + 1 (408) 474-1000 • <http://www.micrel.com>

Ordering Information

Part Number	Voltage	EN	Flag	Adjustable	Junction Temperature Range	Package
MIC39100-1.8WS ⁽¹⁾	1.8V				-40°C to +125°C	SOT-223
MIC39100-2.5WS ⁽¹⁾	2.5V				-40°C to +125°C	SOT-223
MIC39100-3.3WS ⁽¹⁾	3.3V				-40°C to +125°C	SOT-223
MIC39100-5.0WS ⁽¹⁾	5.0V				-40°C to +125°C	SOT-223
MIC39101-1.8YM	1.8V	√	√		-40°C to +125°C	SOIC-8
MIC39101-2.5YM	2.5V	√	√		-40°C to +125°C	SOIC-8
MIC39101-3.3YM	3.3V	√	√		-40°C to +125°C	SOIC-8
MIC39101-5.0YM	5.0V	√	√		-40°C to +125°C	SOIC-8
MIC39102YM	Adjustable	√		√	-40°C to +125°C	SOIC-8

Note:

1. RoHS-compliant with "high-melting solder" exemption.

Pin Configuration

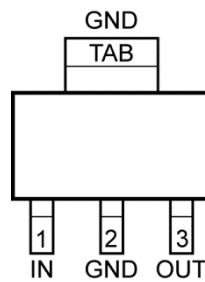

MIC39100-xx
Fixed
SOT-223 (S)
(Top View)

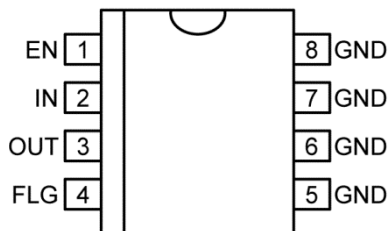

MIC39101-xx
Fixed
SOIC-8 (M)
(Top View)

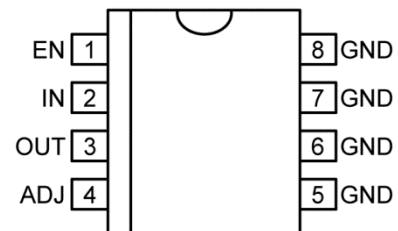

MIC39102
Adjustable
SOIC-8 (M)
(Top View)

Pin Description

Part Number MIC39100	Part Number MIC39101	Part Number MIC39102	Pin Name	Pin Function
	1	1	EN	Enable (Input): CMOS-compatible control input. Logic HIGH = enable; logic LOW or OPEN = shutdown.
1	2	2	IN	Supply (Input)
3	3	3	OUT	Regulator Output.
	4		FLG	Flag (Output): Open-collector error flag output. Active LOW = output undervoltage.
		4	ADJ	Adjustable Input: Feedback input. Connect to resistive voltage-divider network.
2, TAB	5 – 8	5 – 8	GND	Ground.

Absolute Maximum Ratings⁽²⁾

Supply Voltage (V_{IN})	-20V to +20V
Enable Voltage (V_{EN})	+20V
Lead Temperature (soldering, 5s)	260°C
Storage Temperature (T_S)	-65°C to +150°C
ESD Rating	Note 5

Operating Ratings⁽³⁾

Supply Voltage (V_{IN})	+2.25V to +16V
Enable Voltage (V_{EN})	+16V
Maximum Power Dissipation ($P_{D(MAX)}$)	Note 4
Junction Temperature (T_J)	-40°C to +125°C
Package Thermal Resistance	
SOT-223 (θ_{JC})	+15°C/W
SOIC-8 (θ_{JC})	+20°C/W

Electrical Characteristics⁽⁶⁾

$V_{IN} = V_{OUT} + 1V$; $V_{EN} = 2.25V$; $T_J = 25^\circ C$, **bold** values indicate $-40^\circ C \leq T_J \leq +125^\circ C$, unless noted.

Symbol	Parameter	Condition	Min.	Typ.	Max.	Units
V_{OUT}	Output Voltage	10mA	-1		+1	%
		$10mA \leq I_{OUT} \leq 1A$, $V_{OUT} + 1V \leq V_{IN} \leq 8V$	-2		+2	
	Line Regulation	$I_{OUT} = 10mA$, $V_{OUT} + 1V \leq V_{IN} \leq 16V$		0.06	0.5	%
	Load Regulation	$V_{IN} = V_{OUT} + 1V$, $10mA \leq I_{OUT} \leq 1A$		0.2	1	%
$\Delta V_{OUT}/\Delta T$	Output Voltage Temperature Coefficient ⁽⁷⁾			40	100	ppm/°C
V_{DO}	Dropout Voltage ⁽⁸⁾	$I_{OUT} = 100mA$, $\Delta V_{OUT} = -1\%$		140	200 250	mV
		$I_{OUT} = 500mA$, $\Delta V_{OUT} = -1\%$		275		
		$I_{OUT} = 750mA$, $\Delta V_{OUT} = -1\%$		300	500	
		$I_{OUT} = 1A$, $\Delta V_{OUT} = -1\%$		410	550 630	
I_{GND}	Ground Current ⁽⁹⁾	$I_{OUT} = 100mA$, $V_{IN} = V_{OUT} + 1V$		400		μA
		$I_{OUT} = 500mA$, $V_{IN} = V_{OUT} + 1V$		4		mA
		$I_{OUT} = 750mA$, $V_{IN} = V_{OUT} + 1V$		6.5		
		$I_{OUT} = 1A$, $V_{IN} = V_{OUT} + 1V$		11	20	
$I_{OUT(LIM)}$	Current Limit	$V_{OUT} = 0V$, $V_{IN} = V_{OUT} + 1V$		1.8	2.5	A

Notes:

- Exceeding the absolute maximum ratings may damage the device.
- The device is not guaranteed to function outside its operating ratings.
- $P_{D(MAX)} = (T_{J(MAX)} - T_A) \div \theta_{JA}$, where θ_{JA} depends upon the printed circuit layout (see [Applications Information](#)).
- Devices are ESD sensitive. Handling precautions are recommended. Human body model, 1.5k Ω in series with 100pF.
- Specification for packaged product only.
- Output voltage temperature coefficient is $\Delta V_{OUT(WORST CASE)} \div (T_{J(MAX)} - T_{J(MIN)})$, where $T_{J(MAX)} = +125^\circ C$ and $T_{J(MIN)} = -40^\circ C$.
- $V_{DO} = V_{IN} - V_{OUT}$ when V_{OUT} decreases to 99% of its nominal output voltage with $V_{IN} = V_{OUT} + 1V$. For output voltages below 2.25V, dropout voltage is the input-to-output voltage differential with the minimum input voltage being 2.25V. Minimum input operating voltage is 2.25V.
- I_{GND} is the quiescent current ($I_{IN} = I_{GND} + I_{OUT}$).

Electrical Characteristics⁽⁶⁾

$V_{IN} = V_{OUT} + 1V$; $V_{EN} = 2.25V$; $T_J = 25^\circ C$, **bold** values indicate $-40^\circ C \leq T_J \leq +125^\circ C$, unless noted.

Symbol	Parameter	Condition	Min.	Typ.	Max.	Units	
Enable Input							
V_{EN}	Enable Input Voltage	Logic LOW (Off)			0.8	V	
		Logic HIGH (On)	2.25				
I_{EN}	Enable Input Current	$V_{EN} = 2.25V$	1	15	30	μA	
			75				
		$V_{EN} = 0.8V$			2		
					4		
Flag Output							
$I_{FLG(LEAK)}$	Output Leakage Voltage	$V_{OH} = 16V$		0.01	1	μA	
					2		
$V_{FLG(DO)}$	Output Low Voltage	$V_{IN} = 2.250V$, $I_{OL} = 250\mu A^{(10)}$		210	300	mV	
					400		
V_{FLG}	Low Threshold	% of V_{OUT}	93			%	
	High Threshold	% of V_{OUT}			99.2		
	Hysteresis			1			
MIC39102 Only							
	Reference Voltage	$I_{OUT} = 10mA$	1.228	1.240	1.252	V	
			1.215		1.265		
			Note 11		1.203		1.277
	Adjust Pin Bias Current			40	80	nA	
					120		
	Reference Voltage Temperature Coefficient			20		ppm/ $^\circ C$	
	Adjust Pin Bias Current Temperature Coefficient			0.1		nA/ $^\circ C$	

Notes:

10. For a 2.5V device, $V_{IN} = 2.250V$ (device is in dropout).

11. $V_{REF} \leq V_{OUT} \leq (V_{IN} - 1V)$, $2.25V \leq V_{IN} \leq 16V$, $10mA \leq I_L \leq 1A$, $T_J = T_{MAX}$.

Typical Characteristics

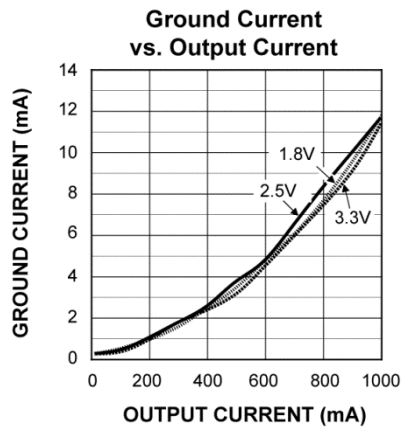
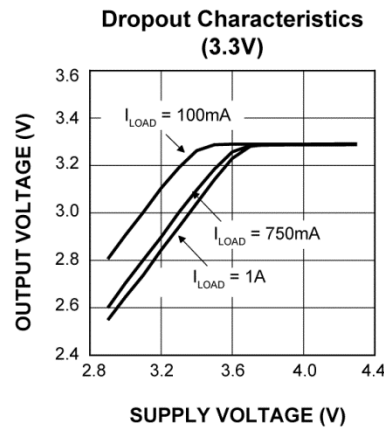
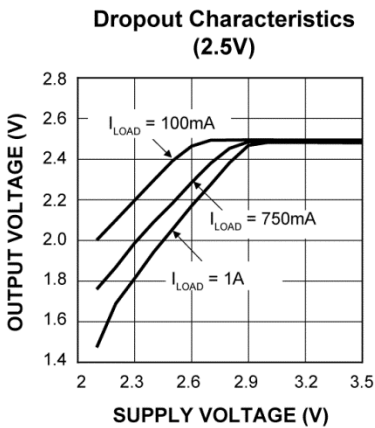
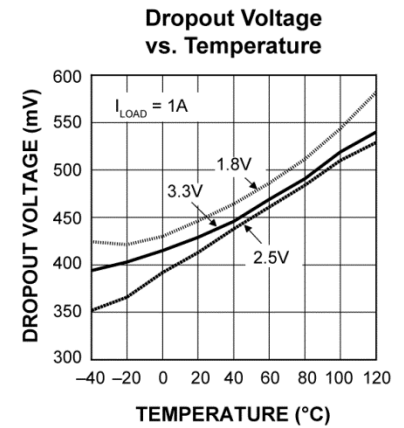
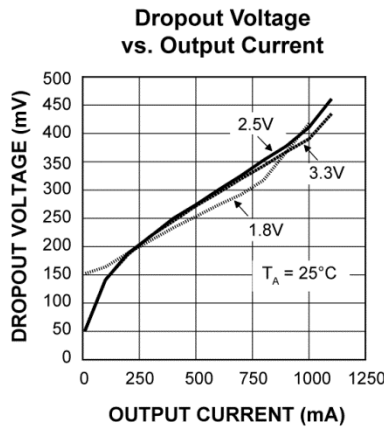
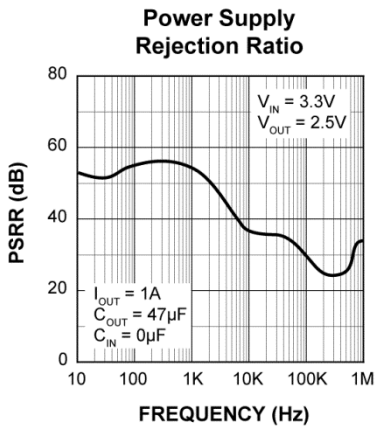
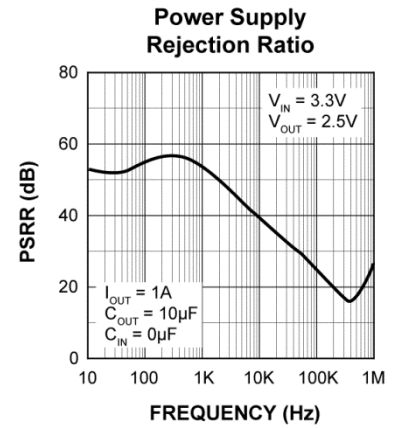
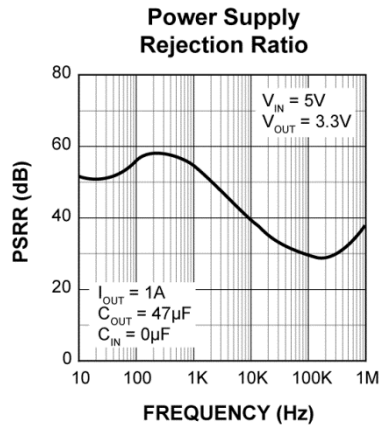
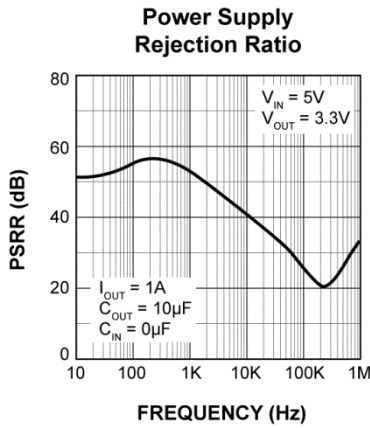

Typical Characteristics (Continued)

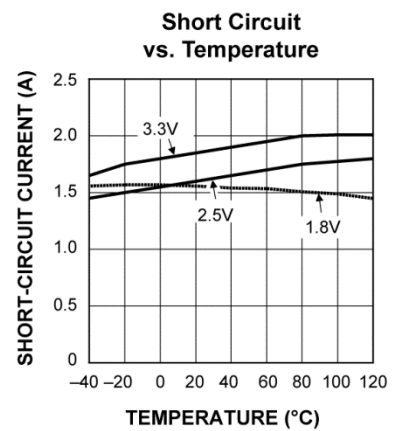
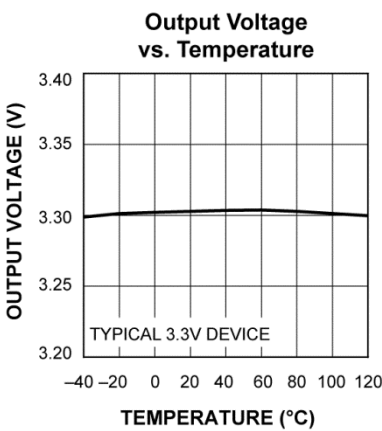
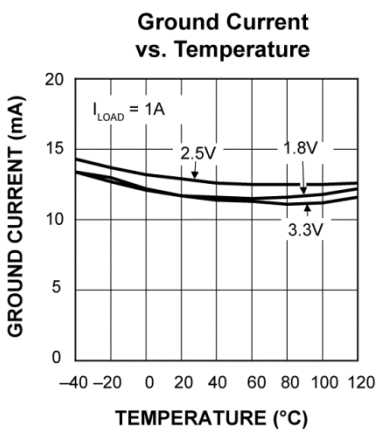
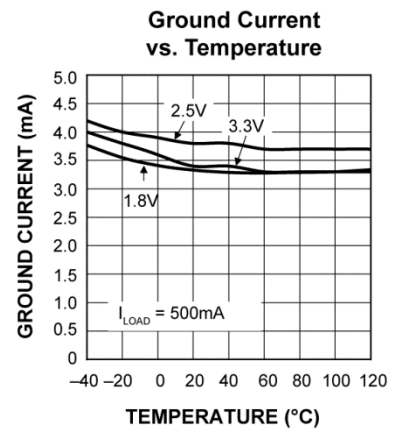
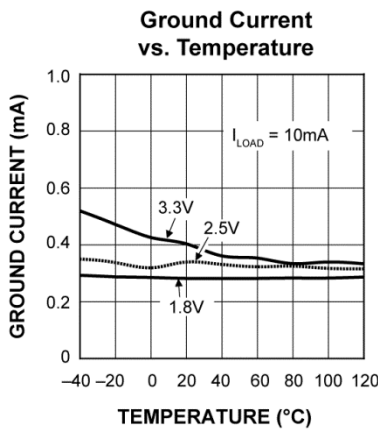
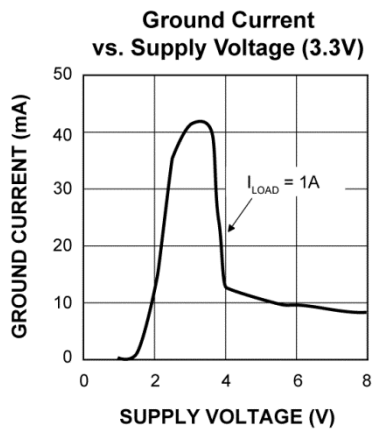
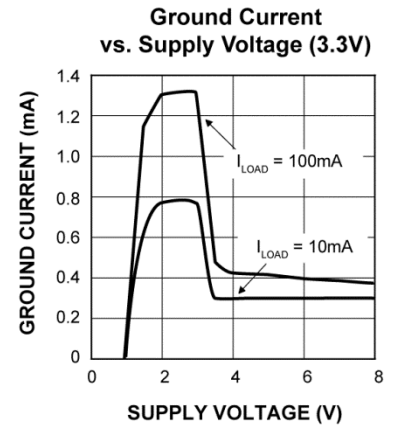
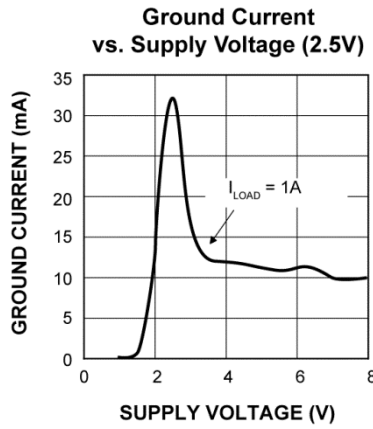
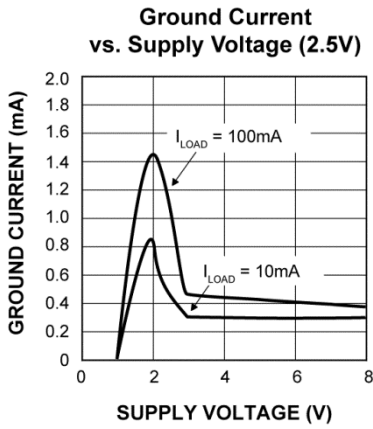

Typical Characteristics (Continued)

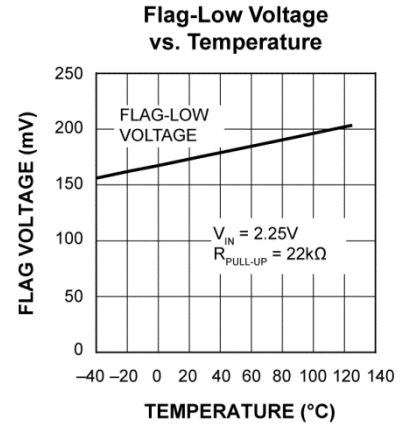
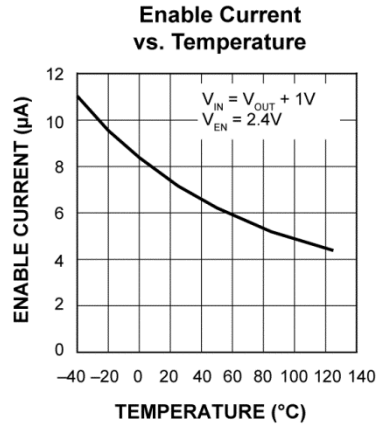
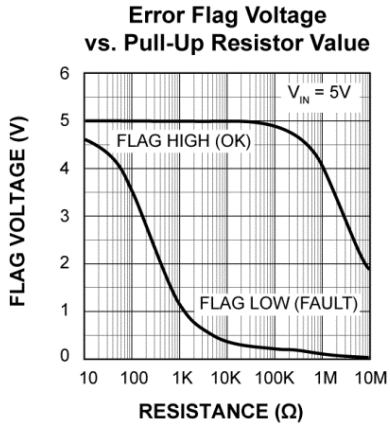

Functional Characteristics

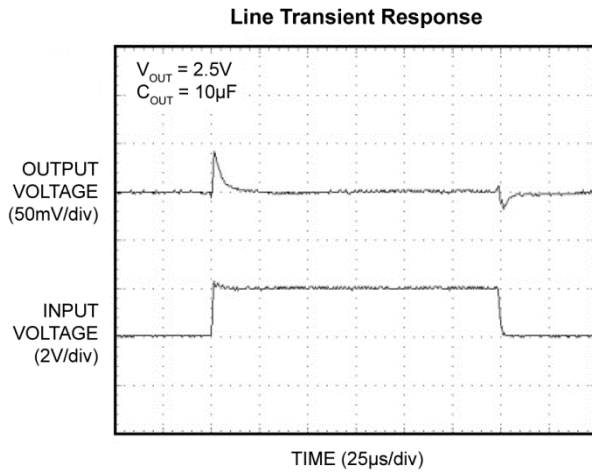
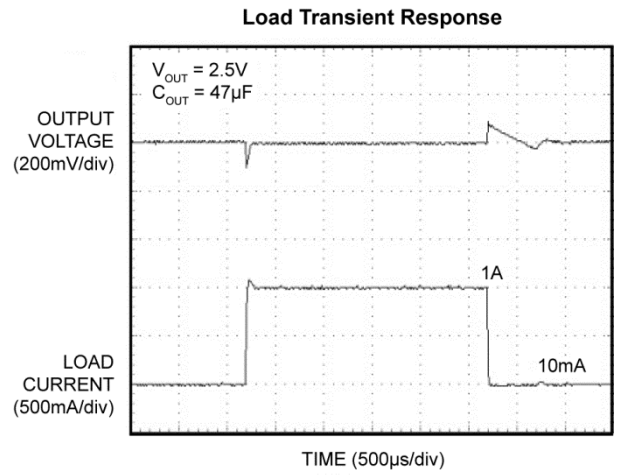
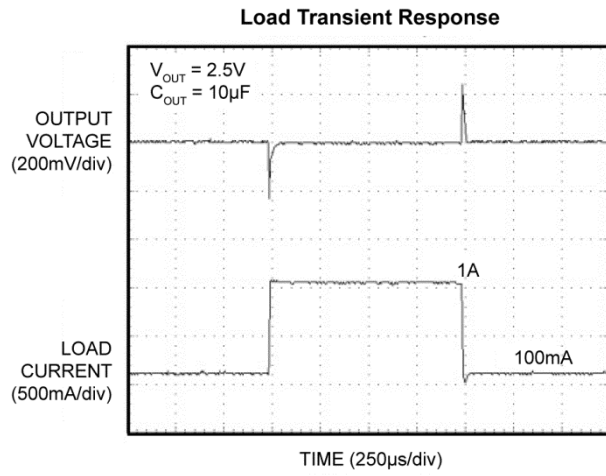

Functional Diagrams

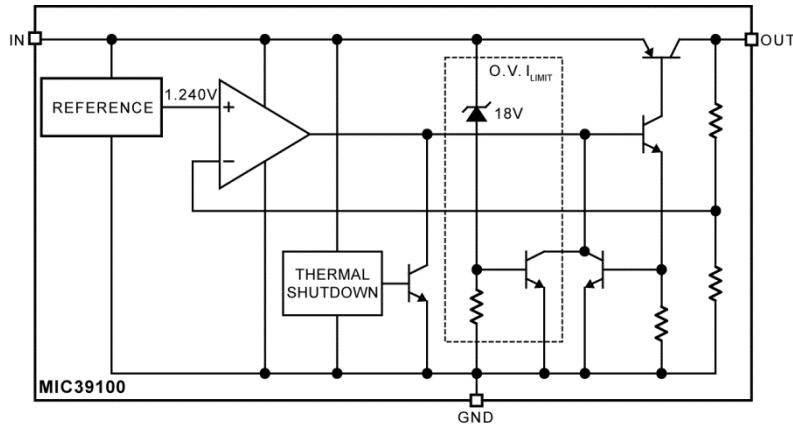

MIC39100 Fixed Regulator Block Diagram

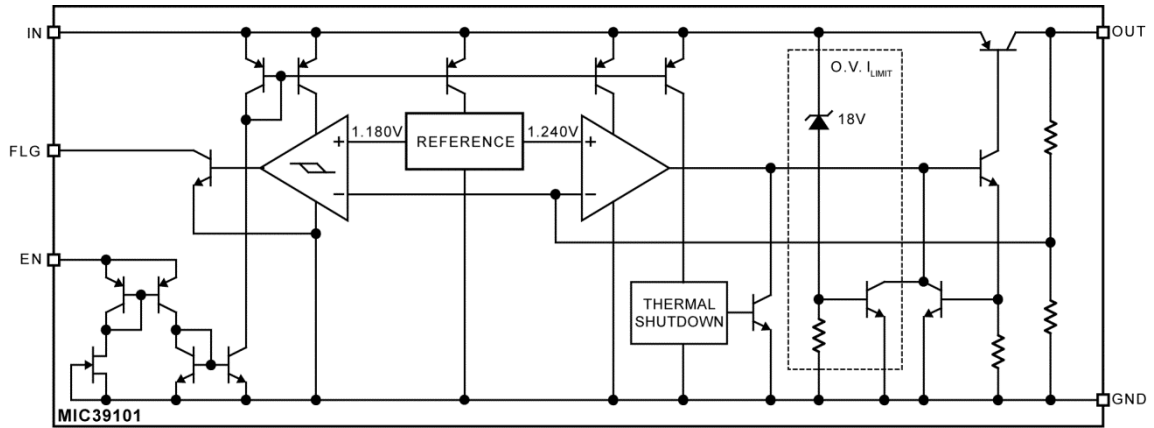

MIC39101 Fixed Regulator with Flag and Enable Block Diagram

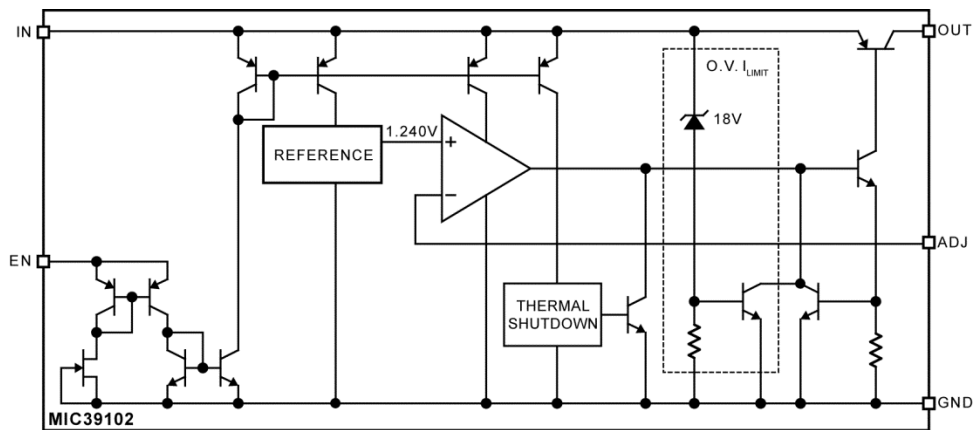

MIC39102 Adjustable Regulator Block Diagram

Applications Information

The MIC39100/1/2 is a high-performance low-dropout voltage regulator suitable for moderate to high-current voltage regulator applications. Its 630mV dropout voltage at full load and overtemperature makes it especially valuable in battery-powered systems and as high-efficiency noise filters in post-regulator applications. Unlike older NPN-pass transistor designs, where the minimum dropout voltage is limited by the base-to-emitter voltage drop and collector-to-emitter saturation voltage, dropout performance of the PNP output of these devices is limited only by the low V_{CE} saturation voltage.

A trade-off for the low dropout voltage is a varying base drive requirement. Micrel's Super β PNP process reduces this drive requirement to only 2% of the load current.

The MIC39100/1/2 regulator is fully protected from damage due to fault conditions. Linear current limiting is provided. Output current during overload conditions is constant. Thermal shutdown disables the device when the die temperature exceeds the maximum safe operating temperature. Transient protection allows device (and load) survival even when the input voltage spikes above and below nominal. The output structure of these regulators allows voltages in excess of the desired output voltage to be applied without reverse current flow.

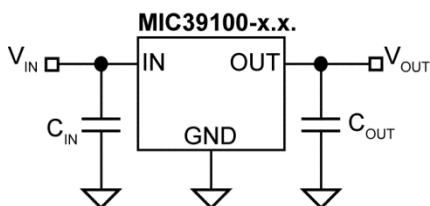

Figure 1. Capacitor Requirements

Output Capacitor

The MIC39100/1/2 requires an output capacitor to maintain stability and improve transient response. Proper capacitor selection is important to ensure proper operation. The MIC39100/1/2 output capacitor selection is dependent upon the equivalent series resistance (ESR) of the output capacitor to maintain stability. When the output capacitor is 10 μ F or greater, the output capacitor should have an ESR less than 2 Ω . This will improve transient response as well as promote stability. Ultra-low ESR capacitors (<100m Ω), such as ceramic-chip capacitors, may promote instability. These very low ESR levels may cause an oscillation and/or underdamped transient response. A low-ESR solid tantalum capacitor works extremely well and provides good transient response and stability over temperature. Aluminum electrolytics can also be used, as long as the ESR of the capacitor is <2 Ω .

The value of the output capacitor can be increased without limit. Higher capacitance values help to improve transient response and ripple rejection and reduce output noise.

Input Capacitor

An input capacitor of 1 μ F or greater is recommended when the device is more than four inches away from the bulk ac supply capacitance or when the supply is a battery. Small, surface mount, ceramic chip capacitors can be used for bypassing. Larger values will help to improve ripple rejection by bypassing the input to the regulator, further improving the integrity of the output voltage.

Error Flag

The MIC39101 features an error flag (FLG), which monitors the output voltage and signals an error condition when this voltage drops 5% below its expected value. The error flag is an open-collector output that pulls low under fault conditions and may sink up to 10mA. Low output voltage signifies a number of possible problems, including an overcurrent fault (the device is in current limit) or low input voltage. The flag output is inoperative during overtemperature conditions. A pull-up resistor from FLG to either VIN or VOUT is required for proper operation. For information regarding the minimum and maximum values of pull-up resistance, refer to the related graph in the [Typical Characteristics](#) section of the datasheet.

Enable Input

The MIC39101 and MIC39102 feature an active-HIGH enable input (EN) that allows on/off control of the regulator. Current drain reduces to zero when the device is shutdown, with only microamperes (μ A) of leakage current. The EN input has TTL/CMOS-comparable thresholds for simple logic interfacing. EN can be directly tied to VIN and pulled-up to the maximum supply voltage.

Transient Response and 3.3V to 2.5V or 2.5V to 1.8V Conversion

The MIC39100/1/2 has excellent transient response to variations in input voltage and load current. The device has been designed to respond quickly to load current variations and input voltage variations. Large output capacitors are not required to obtain this performance. A standard 10 μ F output capacitor, preferably tantalum, is all that is required. Larger values help to improve performance even further.

By virtue of its low-dropout voltage, this device does not saturate into dropout as readily as similar NPN-based designs. When converting from 3.3V to 2.5V or 2.5V to 1.8V, the NPN based regulators are already operating in dropout, with typical dropout requirements of 1.2V or greater. To convert down to 2.5V or 1.8V without operating in dropout, NPN-based regulators require an input voltage of 3.7V at the very least.

The MIC39100 regulator will provide excellent performance with an input as low as 3.0V or 2.5V respectively. This gives the PNP-based regulators a distinct advantage over older, NPN-based linear regulators.

Minimum Load Current

The MIC39100/1/2 regulator is specified between finite loads. If the output current is too small, leakage currents dominate and the output voltage rises. A 10mA minimum load current is necessary for proper regulation.

Adjustable Regulator Design

The MIC39102 allows programming the output voltage anywhere between 1.24V and the 16V maximum operating rating of the family. Two resistors are used. Resistors can be quite large, up to 1MΩ, because of the very high input impedance and low bias current of the sense comparator: The resistor values are calculated by Equation 1:

$$R1 = R2 \left(\frac{V_{OUT}}{1.240V} - 1 \right) \tag{Eq. 1}$$

Where V_{OUT} is the desired output voltage (Figure 2 shows component definition). Applications with widely varying load currents may scale the resistors to draw the minimum load current required for proper operation (Figure 2).

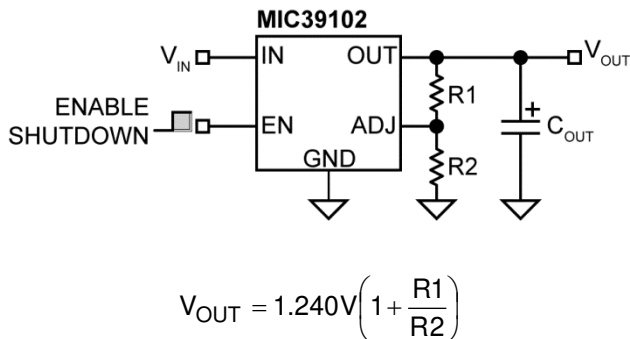

Figure 2. Adjustable Regulator with Resistors

Power SOIC-8 Thermal Characteristics

One of the secrets of the MIC39101/2's performance is its power SO-8 package. Lower thermal resistance means more output current or higher input voltage for a given package size.

Lower thermal resistance is achieved by joining the four ground leads with the die attach paddle to create a single-piece electrical and thermal conductor. This concept has been used by MOSFET manufacturers for years, proving very reliable and cost effective for the user.

Thermal resistance consists of two main elements, θ_{JC} (junction-to-case thermal resistance) and θ_{CA} (case-to-ambient thermal resistance, see Figure 3). θ_{JC} is the resistance from the die to the leads of the package. θ_{CA} is the resistance from the leads to the ambient air and it includes θ_{CS} (case- to-sink thermal resistance) and θ_{SA} (sink-to-ambient thermal resistance).

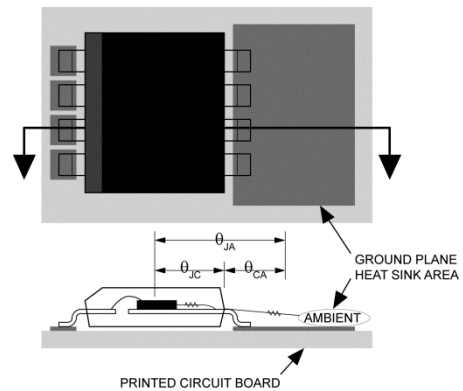

Figure 3. Thermal Resistance

Using the power SOIC-8 reduces the θ_{JC} dramatically and allows the user to reduce θ_{CA} . The total thermal resistance, θ_{JA} , (junction-to-ambient thermal resistance) is the limiting factor in calculating the maximum power dissipation capability of the device. Typically, the power SOIC-8 has a θ_{JC} of 20°C/W, which is significantly lower than the standard SOIC-8 (typically 75°C/W). θ_{CA} is reduced due to the capability of soldering Pins 5 – 8 directly to a ground plane. This significantly reduces the case-to-sink thermal resistance as well as the sink-to-ambient thermal resistance.

Low-dropout linear regulators from Micrel are rated to a maximum junction temperature of 125°C. It is important not to exceed this maximum junction temperature during operation of the device. To prevent this maximum junction temperature from being exceeded, the appropriate ground plane heat sink must be used.

Figure 4 shows copper area versus power dissipation with each trace corresponding to a different temperature rise above ambient.

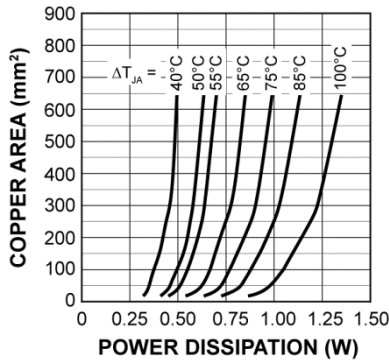

Figure 4. Copper Area vs. Power SOIC Power Dissipation (ΔT_{JA})

From these curves, the minimum area of copper necessary for the part to operate safely can be determined. The maximum allowable temperature rise must be calculated to determine operation along which curve.

For example, the maximum ambient temperature is 50°C, the ΔT is determined as in Equation 2:

$$\begin{aligned} \Delta T &= 125^\circ\text{C} - 50^\circ\text{C} \\ \Delta T &= 75^\circ\text{C} \end{aligned} \quad \text{Eq. 2}$$

Where:

$$\Delta T = T_{J(\text{MAX})} - T_{A(\text{MAX})}$$

$$T_{J(\text{MAX})} = 125^\circ\text{C}$$

$$T_{A(\text{MAX})} = \text{Maximum ambient operating temperature}$$

Using Figure 4, the minimum amount of required copper can be determined based on the required power dissipation. Power dissipation in a linear regulator is calculated as in Equation 3:

$$P_D = (V_{IN} - V_{OUT}) I_{OUT} + V_{IN} \times I_{GND} \quad \text{Eq. 3}$$

If we use a 2.5V output device and a 3.3V input at an output current of 1A, then our power dissipation is as in Equation 4:

$$\begin{aligned} P_D &= (3.3\text{V} - 2.5\text{V}) \times 1\text{A} + 3.3\text{V} \times 11\text{mA} \\ P_D &= 800\text{mW} + 36\text{mW} \\ P_D &= 836\text{mW} \end{aligned} \quad \text{Eq. 4}$$

From Figure 4, the minimum amount of copper required to operate this application at a ΔT of 75°C is 160mm².

Quick Method

Determine the power dissipation requirements for the design along with the maximum ambient temperature at which the device will be operated. Refer to Figure 5, which shows safe operating curves for three different ambient temperatures: 25°C, 50°C, and 85°C. From these curves, the minimum amount of copper can be determined by knowing the maximum power dissipation required. If the maximum ambient temperature is 50°C and the power dissipation is as above, 836mW, the curve in Figure 5 shows that the required area of copper is 160mm².

The θ_{JA} of this package is ideally 63°C/W, but it will vary depending upon the availability of copper ground plane to which it is attached.

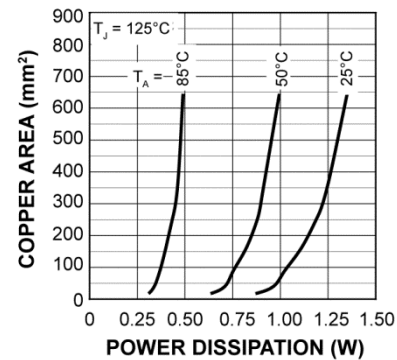
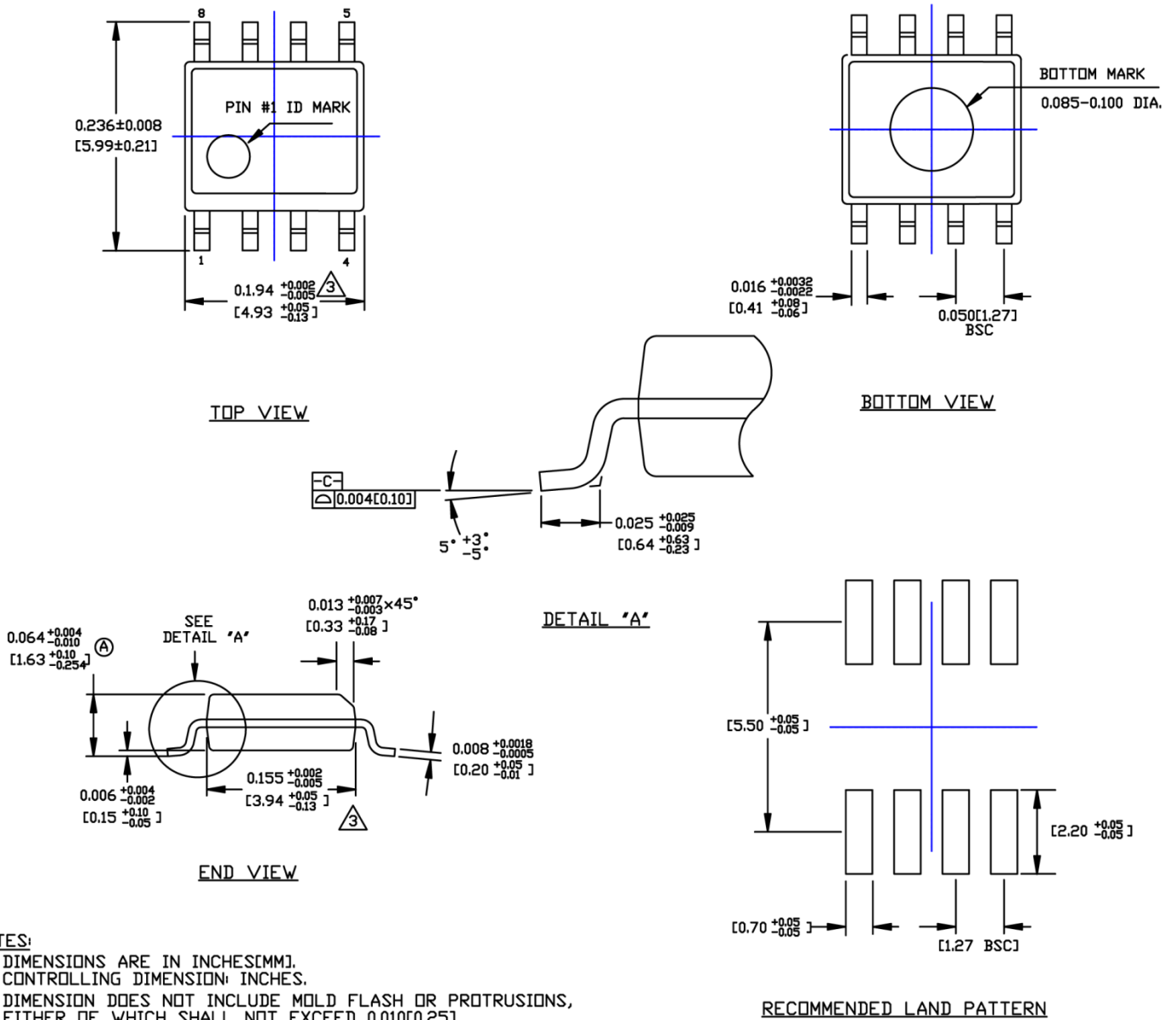

Figure 5. Copper Area vs. Power SOIC Power Dissipation (T_A)

Package Information and Recommended Landing Pattern⁽¹²⁾



8-Pin SOIC (M)

Note:

12. Package information is correct as of the publication date. For updates and most current information, go to www.micrel.com.

Package Information and Recommended Landing Pattern⁽¹²⁾

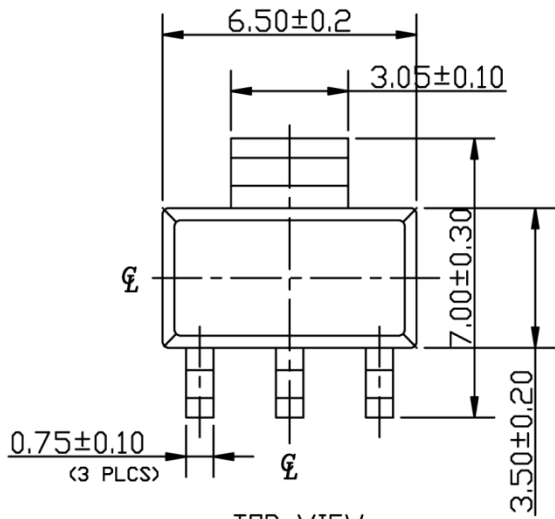

TOP VIEW



SIDE VIEW

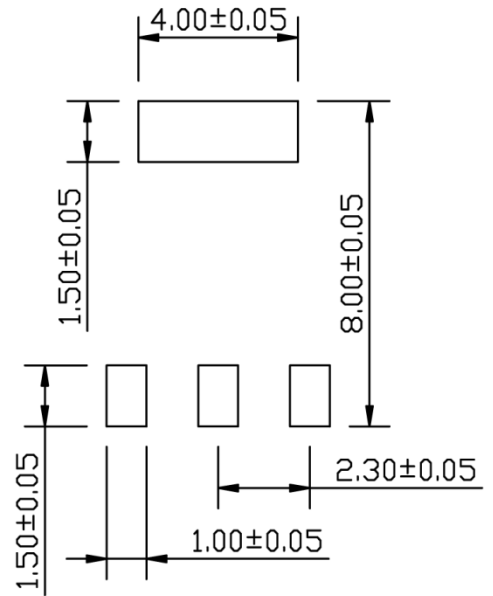

RECOMMENDED LAND PATTERN

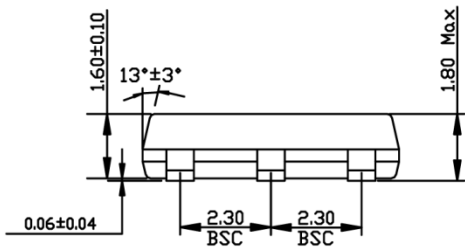

SIDE VIEW

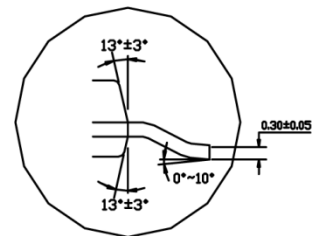

DETAILED VIEW

NOTE:

1. Dimensions and tolerances are as per ANSI Y14.5M, 1982.
2. Controlling dimension: Millimeters.
3. Dimensions are exclusive of mold flash and gate burr.
4. All specification comply to Jedec spec T0261 Issue C.

3-Pin SOT-223 (S)

Revision History

Date	Change Description/Edits by:	Rev.
07/25/05	Initial release of datasheet. No editable file available on Marcom server.	1.0
08/25/05	"B" rev created; no listing of significant changes/edits made present. No editable file available on Marcom server.	2.0
06/03/15	Complete overhaul of DS, including changes to <i>Applications</i> , <i>Electrical Characteristics</i> ⁽⁶⁾ table and Notes, <i>Applications Information</i> , and <i>Package Information and Recommended Landing Pattern</i> ⁽¹²⁾ .	3.0