



Chipsmall Limited consists of a professional team with an average of over 10 year of expertise in the distribution of electronic components. Based in Hongkong, we have already established firm and mutual-benefit business relationships with customers from,Europe,America and south Asia,supplying obsolete and hard-to-find components to meet their specific needs.

With the principle of “Quality Parts,Customers Priority,Honest Operation,and Considerate Service”,our business mainly focus on the distribution of electronic components. Line cards we deal with include Microchip,ALPS,ROHM,Xilinx,Pulse,ON,Everlight and Freescale. Main products comprise IC,Modules,Potentiometer,IC Socket,Relay,Connector.Our parts cover such applications as commercial,industrial, and automotives areas.

We are looking forward to setting up business relationship with you and hope to provide you with the best service and solution. Let us make a better world for our industry!



Contact us

Tel: +86-755-8981 8866 Fax: +86-755-8427 6832

Email & Skype: info@chipsmall.com Web: www.chipsmall.com

Address: A1208, Overseas Decoration Building, #122 Zhenhua RD., Futian, Shenzhen, China





MIC5302

150mA ULDO™ in Ultra-Small
1.2mm x 1.6mm Thin MLF®

General Description

The MIC5302 is an ultra-small, ultra-low dropout CMOS regulator, ULDO™ that is ideal for today's most demanding portable applications including cellular phone RF power, camera modules, imaging sensors for digital still and video cameras, PDAs, portable media players (PMP) and PC cameras where board space is limited. It offers extremely-low dropout voltage, very-low output noise and can operate from a 2.3V to 5.5V input while delivering up to 150mA.

It offers 2% initial accuracy, low ground current (typically 85µA total), thermal- and current-limit protection. The MIC5302 can also be put into a zero-off-mode current state, drawing no current when disabled.

The MIC5302 is available in the ultra small 4-pin 1.2mm x 1.6mm Thin MLF® package, occupying only 1.92mm² of PCB area, a 50% reduction in board area compared to SC-70 and 2mm x 2mm MLF® packages. Its operating junction temperature range is -40°C to +125°C and is available in fixed output voltages in lead-free (RoHS compliant) Thin MLF® package.

Data sheets and support documentation can be found on Micrel's web site at www.micrel.com.

Features

- Ultra-small 1.2mm x 1.6mm Thin MLF® package
- Low dropout voltage: 50mV at 150mA
- Output noise 120µVrms
- Input voltage range: 2.3V to 5.5V
- 150mA guaranteed output current
- Stable with ceramic output capacitors
- Low quiescent current 85µA total
- 35µs turn-on time
- High output accuracy
 - ±2% initial accuracy
 - ±3% over temperature
- Thermal-shutdown and current-limit protection

Applications

- Mobile Phones
- PDAs
- GPS Receivers
- Portable Media Players
- Portable Electronics
- Digital Still & Video Cameras

Typical Application

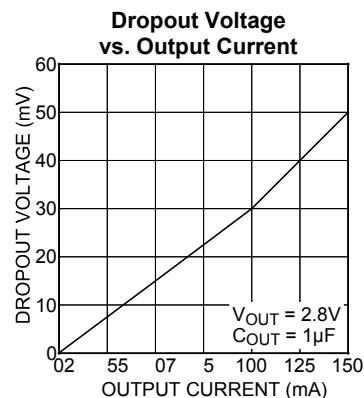
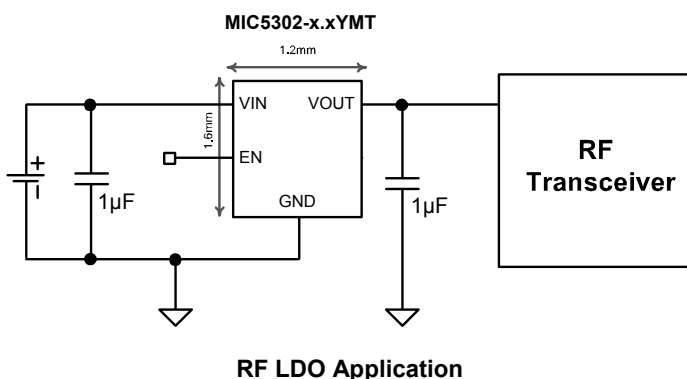

ULDO is a trademark of Micrel, Inc.

MLF and MicroLeadFrame are registered trademarks of Amkor Technology, Inc.

Micrel Inc. • 2180 Fortune Drive • San Jose, CA 95131 • USA • tel +1 (408) 944-0800 • fax + 1 (408) 474-1000 • <http://www.micrel.com>

Block Diagram

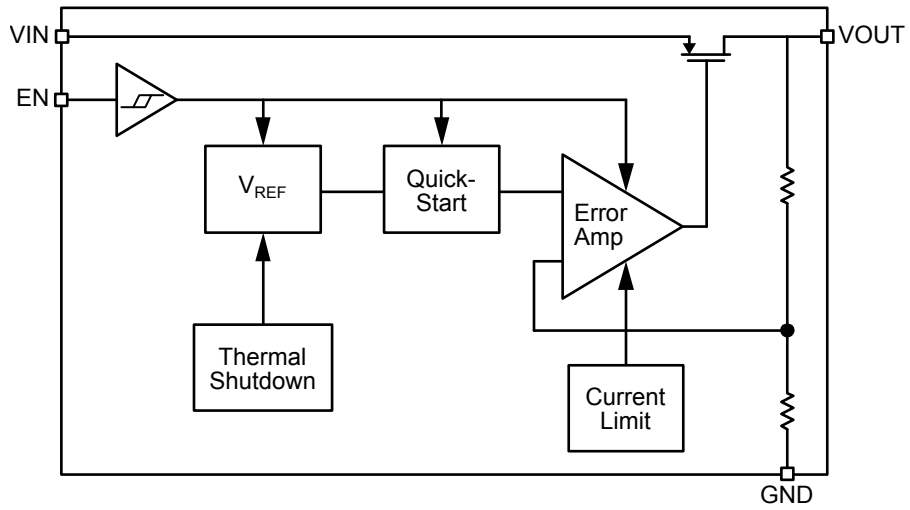

MIC5302 Block Diagram

Ordering Information⁽¹⁾

Part Number	Marking Code	Voltage	Temperature Range	Package	Lead Finish
MIC5302-1.3YMT	H13	1.3V	-40°C to +125°C	4-Pin 1.2mm x 1.6mm Thin MLF [®]	Pb-Free
MIC5302-1.5YMT	H15	1.5V	-40°C to +125°C	4-Pin 1.2mm x 1.6mm Thin MLF [®]	Pb-Free
MIC5302-1.8YMT	H18	1.8V	-40°C to +125°C	4-Pin 1.2mm x 1.6mm Thin MLF [®]	Pb-Free
MIC5302-2.1YMT	H21	2.1V	-40°C to +125°C	4-Pin 1.2mm x 1.6mm Thin MLF [®]	Pb-Free
MIC5302-2.5YMT	H25	2.5V	-40°C to +125°C	4-Pin 1.2mm x 1.6mm Thin MLF [®]	Pb-Free
MIC5302-2.6YMT	H26	2.6V	-40°C to +125°C	4-Pin 1.2mm x 1.6mm Thin MLF [®]	Pb-Free
MIC5302-2.8YMT	H28	2.8V	-40°C to +125°C	4-Pin 1.2mm x 1.6mm Thin MLF [®]	Pb-Free
MIC5302-2.85YMT	H2J	2.85V	-40°C to +125°C	4-Pin 1.2mm x 1.6mm Thin MLF [®]	Pb-Free
MIC5302-2.9YMT	H29	2.9V	-40°C to +125°C	4-Pin 1.2mm x 1.6mm Thin MLF [®]	Pb-Free
MIC5302-3.0YMT	H30	3.0V	-40°C to +125°C	4-Pin 1.2mm x 1.6mm Thin MLF [®]	Pb-Free
MIC5302-3.3YMT	H33	3.3V	-40°C to +125°C	4-Pin 1.2mm x 1.6mm Thin MLF [®]	Pb-Free
MIC5302-4.6YMT	H46	4.6V	-40°C to +125°C	4-Pin 1.2mm x 1.6mm Thin MLF [®]	Pb-Free

Note:

1. Other voltages available. Contact Micrel Marketing for details.

Pin Configuration

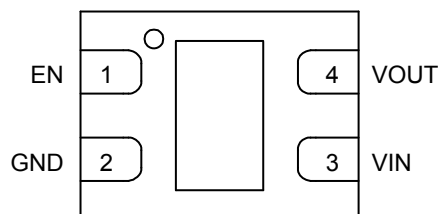

4-Pin 1.2mm x 1.6mm Thin MLF[®] (MT)

Pin Description

Pin Number	Pin Name	Pin Function
1	EN	Enable Input. Active High. High = on, low = off. Do not leave floating.
2	GND	Ground
3	VIN	Supply Input
4	VOUT	Output Voltage
HS Pad	EPAD	Exposed heatsink pad connected to ground internally.

Absolute Maximum Ratings⁽¹⁾

Supply Voltage (V_{IN})	0V to +6V
Enable Input (V_{EN})	0V to +6V
Power Dissipation ⁽³⁾	Internally Limited
Lead Temperature (soldering, 5 sec.)	260°C
Junction Temperature (T_J)	-40°C to +125°C
Storage Temperature (T_S)	-65°C to +150°C

Operating Ratings⁽²⁾

Supply voltage (V_{IN})	+2.3V to +5.5V
Enable Input (V_{EN})	0V to V_{IN}
Junction Temperature (T_A)	-40°C to +125°C
Junction Thermal Resistance	
Thin MLF [®] -4 (θ_{JA})	173°C/W

Electrical Characteristics⁽⁴⁾

$V_{IN} = V_{OUT} + 1V$; $C_{OUT} = 1.0\mu F$; $I_{OUT} = 100\mu A$; $T_J = 25^\circ C$, **bold** values indicate -40°C to +125°C, unless noted.

Parameter	Condition	Min	Typ	Max	Units
Output Voltage Accuracy	Variation from nominal V_{OUT}	-2		+2	%
	Variation from nominal V_{OUT} ; -40°C to +125°C	-3		+3	%
Line Regulation	$V_{IN} = V_{OUT} + 1V$ to 5.5V; $I_{OUT} = 100\mu A$		0.02	0.3 0.6	%/V
Load Regulation ⁽⁵⁾	$I_{OUT} = 100\mu A$ to 150mA		0.5	2.0	%
Dropout Voltage ⁽⁶⁾	$I_{OUT} = 100\mu A$		0.1		mV
	$I_{OUT} = 50mA$		15	35	mV
	$I_{OUT} = 100mA$		30		mV
	$I_{OUT} = 150mA$		50	100	mV
Ground Pin Current ⁽⁷⁾	$I_{OUT} = 0$ to 150mA, EN = High		85	120	μA
Ground Pin Current in Shutdown	$V_{EN} = 0V$		0.1	2	μA
Ripple Rejection	$f =$ up to 1kHz; $C_{OUT} = 1.0\mu F$		65		dB
	$f = 1kHz - 20kHz$; $C_{OUT} = 1.0\mu F$		42		dB
Current Limit	$V_{OUT} = 0V$	250	400	725	mA
Output Voltage Noise	$C_{OUT} = 1\mu F$, 10Hz to 100kHz		120		μV_{RMS}
Enable Input					
Enable Input Voltage	Logic Low			0.2	V
	Logic High	1.1			V
Enable Input Current	$V_{IL} \leq 0.2V$		0.01	1	μA
	$V_{IH} \geq 1.0V$		0.01	1	μA
Turn-on Time	$C_{OUT} = 1.0\mu F$		35	100	μs

Notes:

- Exceeding the absolute maximum rating may damage the device.
- The device is not guaranteed to function outside its operating rating.
- The maximum allowable power dissipation of any T_A (ambient temperature) is $P_{D(max)} = (T_{J(max)} - T_A) / \theta_{JA}$. Exceeding the maximum allowable power dissipation will result in excessive die temperature, and the regulator will go into thermal shutdown.
- Specification for packaged product only.
- Regulation is measured at constant junction temperature using low duty cycle pulse testing, changes in output voltage due to heating effects are covered by the thermal regulation specification.
- Dropout voltage is defined as the input-to-output differential at which the output voltage drops 2% below its nominal value measured at 1V differential.
- Ground pin current is the regulator quiescent current. The total current drawn from the supply is the sum of the load current plus the ground pin current.

Typical Characteristics

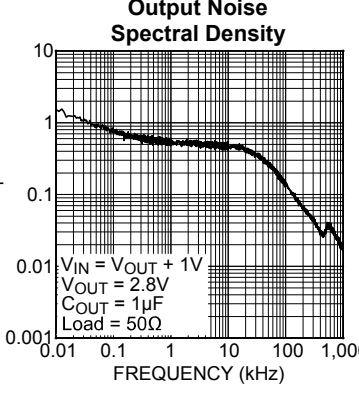
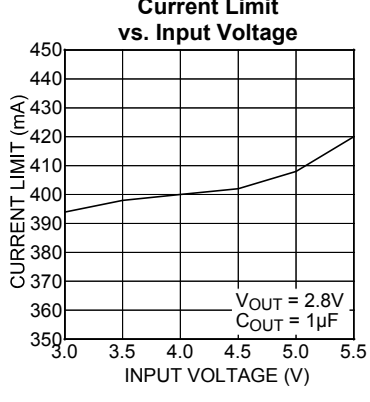
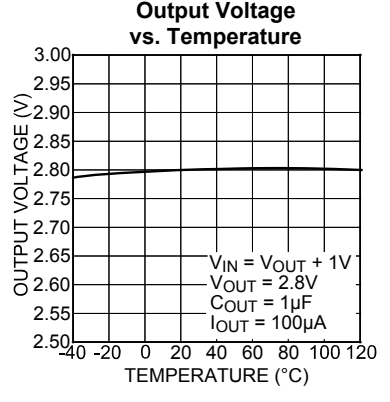
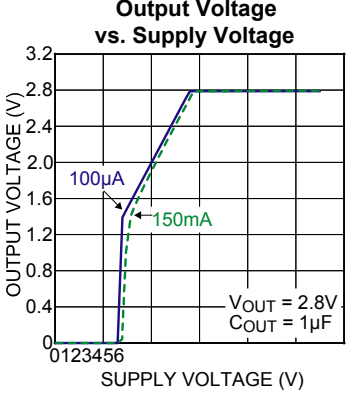
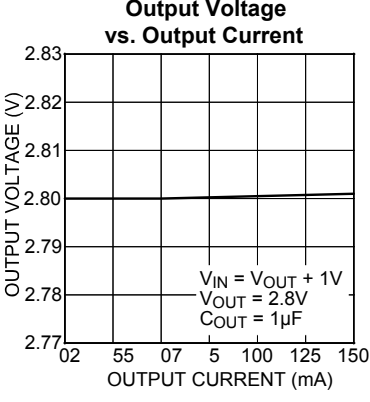
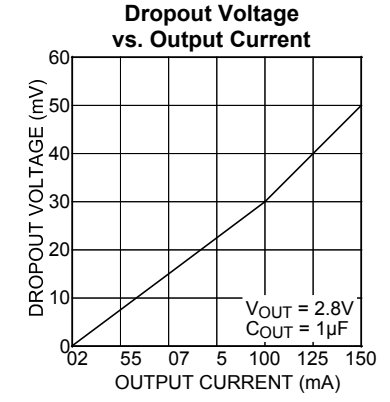
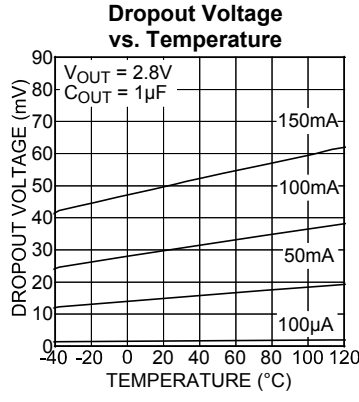
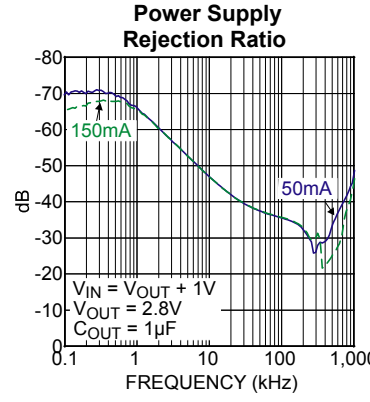
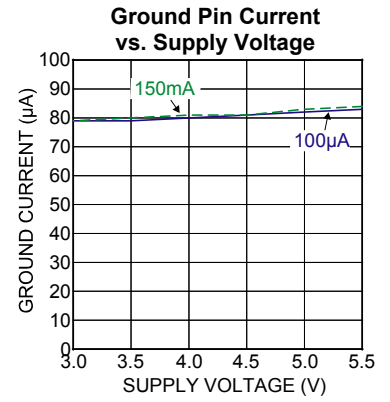
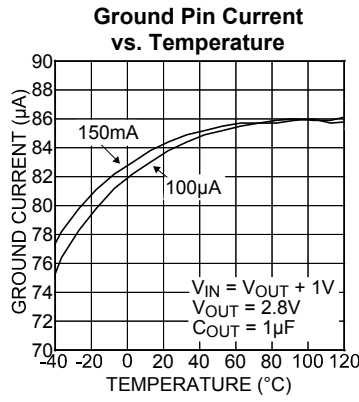
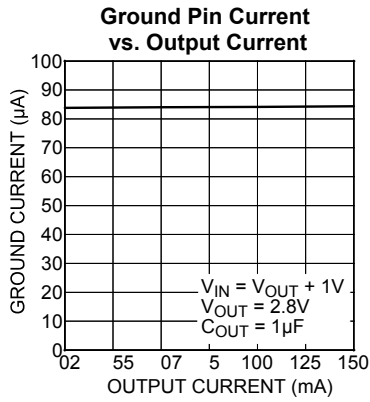

Functional Characteristics

Enable Turn-On

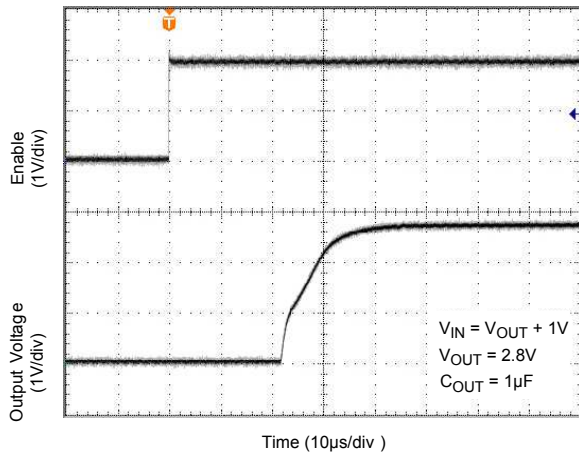

Load Transient Response

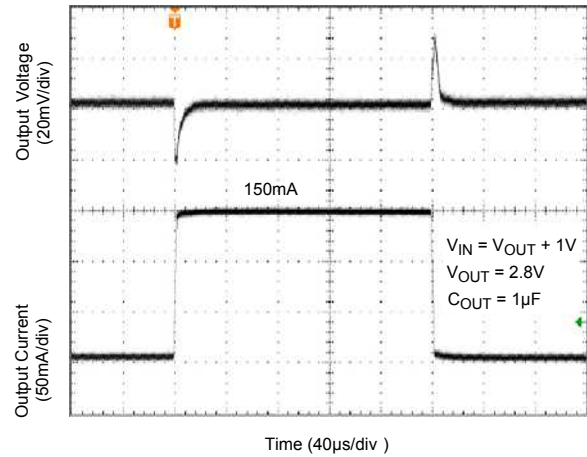

Line Transient Response

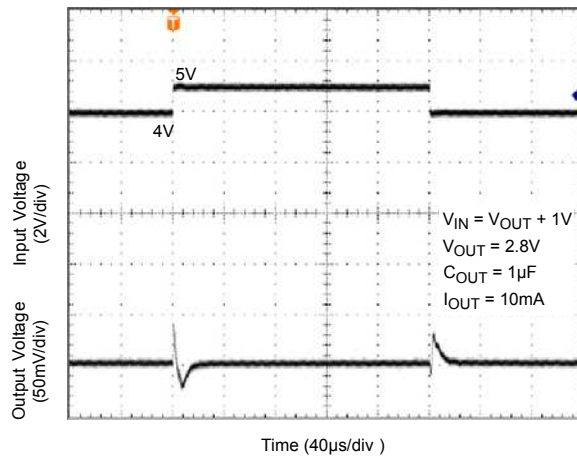

Application Information

Enable/Shutdown

The MIC5302 comes with an active-high enable pin that allows the regulator to be disabled. Forcing the enable pin low disables the regulator and sends it into a “zero” off-mode-current state. In this state, current consumed by the regulator goes nearly to zero. Forcing the enable pin high enables the output voltage. The active-high enable pin uses CMOS technology and the enable pin cannot be left floating; a floating enable pin may cause an indeterminate state on the output.

Input Capacitor

The MIC5302 is a high-performance, high-bandwidth device. Therefore, it requires a well-bypassed input supply for optimal performance. A 1 μ F capacitor is required from the input-to-ground to provide stability. Low-ESR ceramic capacitors provide optimal performance at a minimum of space. Additional high-frequency capacitors, such as small-valued NPO dielectric-type capacitors, help filter out high-frequency noise and are good practice in any RF-based circuit.

Output Capacitor

The MIC5302 requires an output capacitor of 1 μ F or greater to maintain stability. The design is optimized for use with low-ESR ceramic chip capacitors. High ESR capacitors may cause high frequency oscillation. The output capacitor can be increased, but performance has been optimized for a 1 μ F ceramic output capacitor and does not improve significantly with larger capacitance.

X7R/X5R dielectric-type ceramic capacitors are recommended because of their temperature performance. X7R-type capacitors change capacitance by 15% over their operating temperature range and are the most stable type of ceramic capacitors. Z5U and Y5V dielectric capacitors change value by as much as 50% and 60%, respectively, over their operating temperature ranges. To use a ceramic chip capacitor with Y5V dielectric, the value must be much higher than an X7R ceramic capacitor to ensure the same minimum capacitance over the equivalent operating temperature range.

No-Load Stability

Unlike many other voltage regulators, the MIC5302 will remain stable and in regulation with no load. This is especially important in CMOS RAM keep-alive applications.

Thermal Considerations

The MIC5302 is designed to provide 150mA of continuous current. Maximum ambient operating temperature can be calculated based on the output current and the voltage drop across the part. Given that the input voltage is 3.6V, the output voltage is 2.8V and the output current = 150mA.

The actual power dissipation of the regulator circuit can be determined using the equation:

$$P_D = (V_{IN} - V_{OUT}) I_{OUT} + V_{IN} I_{GND}$$

Because this device is CMOS and the ground current is typically <100 μ A over the load range, the power dissipation contributed by the ground current is < 1% and can be ignored for this calculation.

$$P_D = (3.6V - 2.8V) \times 150mA$$

$$P_D = 0.12W$$

To determine the maximum ambient operating temperature of the package, use the junction-to-ambient thermal resistance of the device and the following basic equation:

$$P_{D(MAX)} = \left(\frac{T_{J(MAX)} - T_A}{\theta_{JA}} \right)$$

$T_{J(max)} = 125^\circ\text{C}$, the maximum junction temperature of the die θ_{JA} thermal resistance = 173 $^\circ\text{C/W}$.

The table below shows junction-to-ambient thermal resistance for the MIC5302 in the 4-pin 1.2mm x 1.6mm MLF[®] package.

Package	θ_{JA} Recommended Minimum Footprint
4-Pin 1.2x1.6 MLF [®]	173 $^\circ\text{C/W}$

Thermal Resistance

Substituting P_D for $P_{D(max)}$ and solving for the ambient operating temperature will give the maximum operating conditions for the regulator circuit. The junction-to-ambient thermal resistance for the minimum footprint is 173 $^\circ\text{C/W}$.

The maximum power dissipation must not be exceeded for proper operation.

For example, when operating the MIC5302-2.8YML at an input voltage of 3.6V and 150mA load with a minimum footprint layout, the maximum ambient operating temperature T_A can be determined as follows:

$$0.12W = (125^\circ\text{C} - T_A)/(173^\circ\text{C/W})$$

$$T_A = 104^\circ\text{C}$$

Therefore, a 2.8V application with 150mA of output current can accept an ambient operating temperature of 104 $^\circ\text{C}$ in a 1.2mm x 1.6mm MLF[®] package. For a full discussion of heat sinking and thermal effects on voltage regulators, refer to the “Regulator Thermals” section of *Micrel’s Designing with Low-Dropout Voltage Regulators* handbook. This information can be found on Micrel’s website at:

http://www.micrel.com/PDF/other/LDOBk_ds.pdf

Package Information

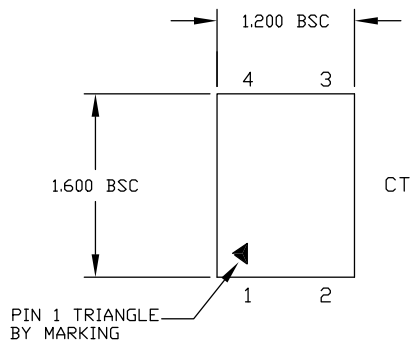

TOP VIEW

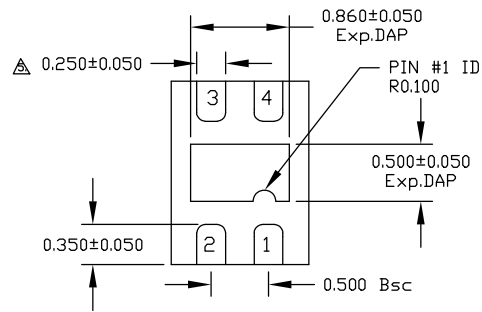

BOTTOM VIEW

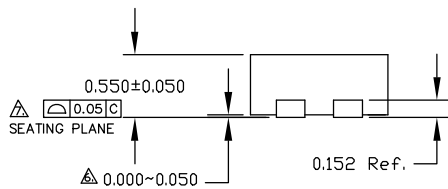

SIDE VIEW

- NOTE:
1. ALL DIMENSIONS ARE IN MILLIMETERS.
 2. MAX. PACKAGE WARPAGE IS 0.05 mm.
 3. MAXIMUM ALLOWABLE BURRS IS 0.076 mm IN ALL DIRECTIONS.
 4. PIN #1 ID ON TOP WILL BE LASER/INK MARKED.
- △ DIMENSION APPLIES TO METALIZED TERMINAL AND IS MEASURED BETWEEN 0.20 AND 0.25 mm FROM TERMINAL TIP.
- △ APPLIED ONLY FOR TERMINALS.
- △ APPLIED FOR EXPOSED PAD AND TERMINALS.

4-Pin 1.2mm x 1.6mm Thin MLF® (MT)

MICREL, INC. 2180 FORTUNE DRIVE SAN JOSE, CA 95131 USA
 TEL +1 (408) 944-0800 FAX +1 (408) 474-1000 WEB <http://www.micrel.com>

The information furnished by Micrel in this data sheet is believed to be accurate and reliable. However, no responsibility is assumed by Micrel for its use. Micrel reserves the right to change circuitry and specifications at any time without notification to the customer.

Micrel Products are not designed or authorized for use as components in life support appliances, devices or systems where malfunction of a product can reasonably be expected to result in personal injury. Life support devices or systems are devices or systems that (a) are intended for surgical implant into the body or (b) support or sustain life, and whose failure to perform can be reasonably expected to result in a significant injury to the user. A Purchaser's use or sale of Micrel Products for use in life support appliances, devices or systems is a Purchaser's own risk and Purchaser agrees to fully indemnify Micrel for any damages resulting from such use or sale.

© 2006 Micrel, Incorporated.