



Chipsmall Limited consists of a professional team with an average of over 10 year of expertise in the distribution of electronic components. Based in Hongkong, we have already established firm and mutual-benefit business relationships with customers from,Europe,America and south Asia,supplying obsolete and hard-to-find components to meet their specific needs.

With the principle of "Quality Parts,Customers Priority,Honest Operation,and Considerate Service",our business mainly focus on the distribution of electronic components. Line cards we deal with include Microchip,ALPS,ROHM,Xilinx,Pulse,ON,Everlight and Freescale. Main products comprise IC,Modules,Potentiometer,IC Socket,Relay,Connector.Our parts cover such applications as commercial,industrial, and automotives areas.

We are looking forward to setting up business relationship with you and hope to provide you with the best service and solution. Let us make a better world for our industry!



Contact us

Tel: +86-755-8981 8866 Fax: +86-755-8427 6832

Email & Skype: info@chipsmall.com Web: www.chipsmall.com

Address: A1208, Overseas Decoration Building, #122 Zhenhua RD., Futian, Shenzhen, China





MIC94080/1/2/3/4/5

67mΩ R_{DS(on)} 2A High Side Load Switch
in 0.85mm x 0.85mm Thin MLF® Package

General Description

The MIC94080/1/2/3/4/5 is a family of high-side load switches designed to operate from 1.7V to 5.5V input voltage. The load switch pass element is an internal 67mΩ R_{DS(on)} P-Channel MOSFET which enables the device to support up to 2A of continuous current. Additionally, the load switch supports 1.5V logic level control and shutdown features in a tiny 0.85mm x 0.85mm 4-pin Thin MLF® package.

The MIC94080 and MIC94081 feature rapid turn on. The MIC94082 and MIC94083 provide a slew rate controlled soft-start turn-on of 800μs, while the MIC94084 and MIC94085 provide a slew rate controlled soft-start turn-on of 120μs. The soft-start feature is provided to prevent an in-rush current event from pulling down the input supply voltage.

The MIC94081, MIC94083, and MIC94085 feature an active load discharge circuit which switches in a 250Ω load when the switch is disabled to automatically discharge a capacitive load.

An active pull-down on the enable input keeps the MIC94080/1/2/3/4/5 in a default OFF state until the enable pin is pulled above 1.25V. Internal level shift circuitry allows low voltage logic signals to switch higher supply voltages. The enable voltage can be as high as 5.5V and is not limited by the input voltage.

The MIC94080/1/2/3/4/5 operating voltage range makes them ideal for Lithium ion and NiMH/NiCad/Alkaline battery powered systems, as well as non-battery powered applications. The devices provide low quiescent current and low shutdown current to maximize battery life.

Datasheets and support documentation can be found on Micrel's web site at: www.micrel.com.

Features

- 0.85mm x 0.85mm space saving 4-pin Thin MLF® package
- 1.7V to 5.5V input voltage range
- 2A continuous operating current
- 67mΩ R_{DS(on)}
- Internal level shift for CMOS/TTL control logic
- Ultra low quiescent current
- Micro-power shutdown current
- Soft-Start: MIC94082/3 (800μs), MIC94084/5 (120μs)
- Load discharge circuit: MIC94081, MIC94083, MIC94085
- Ultra fast turn off time
- Junction operating temperature from -40°C to +125°C

Applications

- Cellular phones
- Portable Navigation Devices (PND)
- Personal Media Players (PMP)
- Ultra Mobile PCs
- Portable instrumentation
- Other Portable applications
- PDAs
- GPS Modules
- Industrial and DataComm equipment

Typical Application

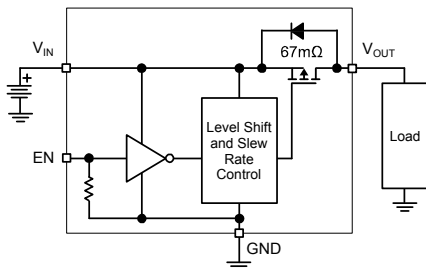

MIC94080 (ultra fast turn on)
MIC94082 (800μs soft-start)
MIC94084 (120μs soft-start)

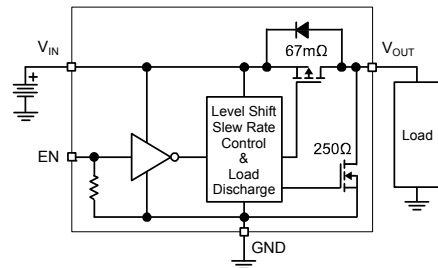

MIC94081 (ultra fast turn on with auto-discharge)
MIC94083 (800μs soft-start with auto-discharge)
MIC94085 (120μs soft-start with auto-discharge)

MLF and MicroLeadFrame is a registered trademark of Amkor Technology, Inc.

Micrel Inc. • 2180 Fortune Drive • San Jose, CA 95131 • USA • tel +1 (408) 944-0800 • fax + 1 (408) 474-1000 • <http://www.micrel.com>

Ordering Information

Part Number	Part Marking	Fast Turn On	Soft-Start	Load Discharge	Package ⁽¹⁾
MIC94080YFT	C1	•			4-Pin 0.85mm x 0.85mm Thin MLF [®]
MIC94081YFT	C2	•		•	4-Pin 0.85mm x 0.85mm Thin MLF [®]
MIC94082YFT	C5		800 μ s		4-Pin 0.85mm x 0.85mm Thin MLF [®]
MIC94083YFT	C7		800 μ s	•	4-Pin 0.85mm x 0.85mm Thin MLF [®]
MIC94084YFT	C0		120 μ s		4-Pin 0.85mm x 0.85mm Thin MLF [®]
MIC94085YFT	1C		120 μ s	•	4-Pin 0.85mm x 0.85mm Thin MLF [®]

Notes:

1. Thin MLF[®] is a GREEN RoHS-compliant package. Lead finish is NiPdAu. Mold compound is Halogen Free.

Pin Configuration

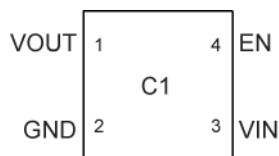

4-Pin (0.85mm x 0.85mm) Thin MLF[®]
(Top View)

Example Showing Orientation of Part Marking

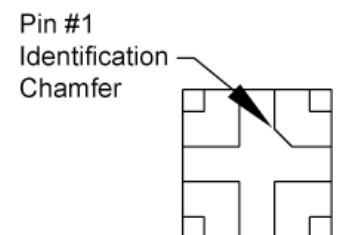

(Bottom View)

Pin Description

Pin Number	Pin Name	Pin Function
1	V _{OUT}	Drain of P-Channel MOSFET.
2	GND	Ground should be connected to electrical ground.
3	V _{IN}	Source of P-Channel MOSFET.
4	EN	Enable (Input): Active-high CMOS/TTL control input for switch. Internal ~2M Ω Pull down resistor. Output will be off if this pin is left floating.

Absolute Maximum Ratings⁽¹⁾

Input Voltage (V_{IN})	+6V
Enable Voltage (V_{EN})	+6V
Continuous Drain Current (I_D) ⁽³⁾	
$T_A = 25^\circ\text{C}$	$\pm 2\text{A}$
$T_A = 85^\circ\text{C}$	$\pm 1.5\text{A}$
Pulsed Drain Current (I_{DP}) ⁽⁴⁾	$\pm 6.0\text{A}$
Continuous Diode Current (I_S) ⁽⁵⁾	-50mA
Storage Temperature (T_S)	-55°C to +150°C
ESD Rating – HBM ⁽⁶⁾	3kV

Operating Ratings⁽²⁾

Input Voltage (V_{IN})	+1.7 to +5.5V
Junction Temperature (T_J)	-40°C to +125°C
Package Thermal Resistance	
0.85mm x 0.85mm Thin MLF [®]	
(θ_{JA})	140°C/W
(θ_{JC})	85°C/W

Electrical Characteristics

$T_A = 25^\circ\text{C}$, bold values indicate $-40^\circ\text{C} \leq T_A \leq +85^\circ\text{C}$, unless noted.

Symbol	Parameter	Condition	Min	Typ	Max	Units
V_{EN_TH}	Enable Threshold Voltage	$V_{IN} = 1.7\text{V to } 4.5\text{V}, I_D = -250\mu\text{A}$	0.4		1.25	V
I_Q	Quiescent Current	$V_{IN} = V_{EN} = 5.5\text{V}, I_D = \text{OPEN}$ Measured on V_{IN} MIC94080/1		0.1	1	μA
		$V_{IN} = V_{EN} = 5.5\text{V}, I_D = \text{OPEN}$ Measured on V_{IN} MIC94082/3/4/5		8	15	
I_{EN}	Enable Input Current	$V_{IN} = V_{EN} = 5.5\text{V}, I_D = \text{OPEN}$		2.8	4	μA
I_{SHUT-Q}	Quiescent Current (shutdown)	$V_{IN} = +5.5\text{V}, V_{EN} = 0\text{V}, I_D = \text{OPEN}$ Measured on V_{IN} ⁽⁷⁾		0.02	1	μA
$I_{SHUT-SWITCH}$	OFF State Leakage Current	$V_{IN} = +5.5\text{V}, V_{EN} = 0\text{V}, I_D = \text{SHORT}$ Measured on V_{OUT} , ⁽⁷⁾		0.02	1	μA
$R_{DS(ON)}$	P-Channel Drain to Source ON Resistance	$V_{IN} = +5.0\text{V}, I_D = -100\text{mA}, V_{EN} = 1.5\text{V}$		67	115	m Ω
		$V_{IN} = +4.5\text{V}, I_D = -100\text{mA}, V_{EN} = 1.5\text{V}$		70	130	m Ω
		$V_{IN} = +3.6\text{V}, I_D = -100\text{mA}, V_{EN} = 1.5\text{V}$		80	165	m Ω
		$V_{IN} = +2.5\text{V}, I_D = -100\text{mA}, V_{EN} = 1.5\text{V}$		110	225	m Ω
		$V_{IN} = +1.8\text{V}, I_D = -100\text{mA}, V_{EN} = 1.5\text{V}$		175	350	m Ω
		$V_{IN} = +1.7\text{V}, I_D = -100\text{mA}, V_{EN} = 1.5\text{V}$		200	375	m Ω
$R_{SHUTDOWN}$	Turn-Off Resistance	$V_{IN} = +3.6\text{V}, I_{TEST} = 1\text{mA}, V_{EN} = 0\text{V}$ MIC94081/3/5		250	400	Ω

Notes:

- Exceeding the absolute maximum rating may damage the device.
- The device is not guaranteed to function outside its operating rating.
- With thermal contact to PCB. See thermal considerations section.
- Pulse width <300 μs with < 2% duty cycle.
- Continuous body diode current conduction (reverse conduction, i.e. V_{OUT} to V_{IN}) is not recommended.
- Devices are ESD sensitive. Handling precautions recommended. HBM (Human body model), 1.5k Ω in series with 100pF.
- Measured on the MIC94080YFT.

Electrical Characteristics (Dynamic)

$T_A = 25^\circ\text{C}$, bold values indicate $-40^\circ\text{C} \leq T_A \leq +85^\circ\text{C}$, unless noted.

Symbol	Parameter	Condition	Min	Typ	Max	Units
$t_{\text{ON_DLY}}$	Turn-On Delay Time	$V_{\text{IN}} = +3.6\text{V}$, $I_{\text{D}} = -100\text{mA}$, $V_{\text{EN}} = 1.5\text{V}$ MIC94080, MIC94081		0.40	1.5	μs
		$V_{\text{IN}} = +3.6\text{V}$, $I_{\text{D}} = -100\text{mA}$, $V_{\text{EN}} = 1.5\text{V}$ MIC94082, MIC94083	200	600	1500	μs
		$V_{\text{IN}} = +3.6\text{V}$, $I_{\text{D}} = -100\text{mA}$, $V_{\text{EN}} = 1.5\text{V}$ MIC94084, MIC94085	65	110	165	μs
$t_{\text{ON_RISE}}$	Turn-On Rise Time	$V_{\text{IN}} = +3.6\text{V}$, $I_{\text{D}} = -100\text{mA}$, $V_{\text{EN}} = 1.5\text{V}$ MIC94080, MIC94081		0.4	1.5	μs
		$V_{\text{IN}} = +3.6\text{V}$, $I_{\text{D}} = -100\text{mA}$, $V_{\text{EN}} = 1.5\text{V}$ MIC94082, MIC94083	400	800	1500	μs
		$V_{\text{IN}} = +3.6\text{V}$, $I_{\text{D}} = -100\text{mA}$, $V_{\text{EN}} = 1.5\text{V}$ MIC94084, MIC94085	65	120	175	μs
$t_{\text{OFF_DLY}}$	Turn-Off Delay Time	$V_{\text{IN}} = +3.6\text{V}$, $I_{\text{D}} = -100\text{mA}$, $V_{\text{EN}} = 0\text{V}$		60	200	ns
$t_{\text{OFF_FALL}}$	Turn-Off Fall Time	$V_{\text{IN}} = +3.6\text{V}$, $I_{\text{D}} = -100\text{mA}$, $V_{\text{EN}} = 0\text{V}$		20	100	ns

Typical Characteristics

MIC94080/1/2/3/4/5

R_{DSon} Variance vs. Temperature

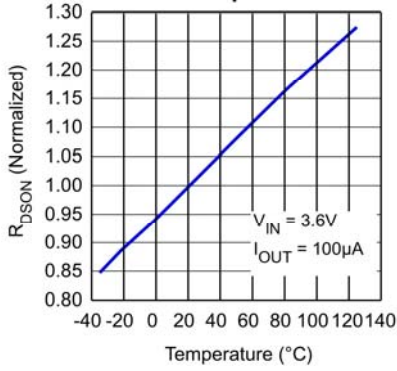

MIC94080/1/2/3/4/5

Voltage Drop vs. Load Current

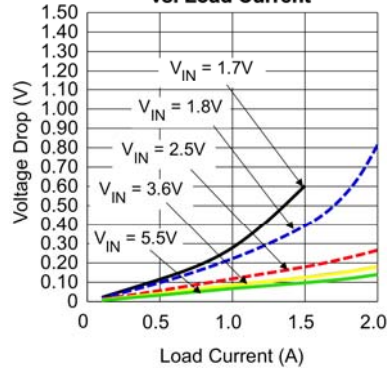

MIC94080/1/2/3/4/5

On Resistance vs. Input Voltage

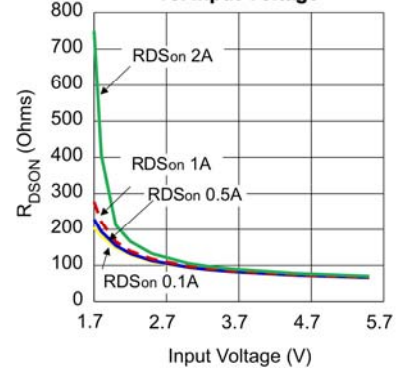

MIC94080/1

Enable Threshold vs. Input Voltage

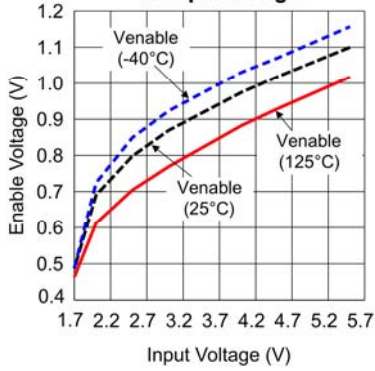

MIC94082/83/84/85

Enable Threshold vs. Input Voltage

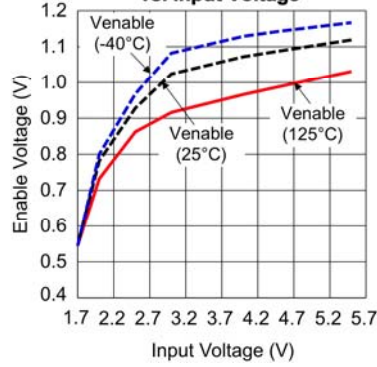

MIC94080/81

Input Current vs. Temperature

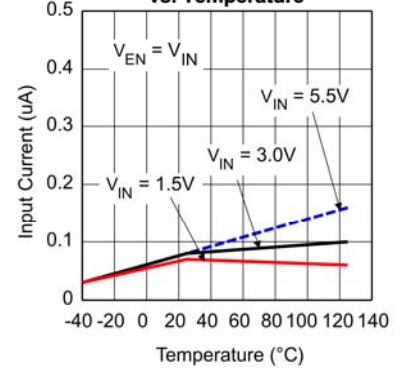

MIC94082/3/4/5

Input Current vs. Temperature

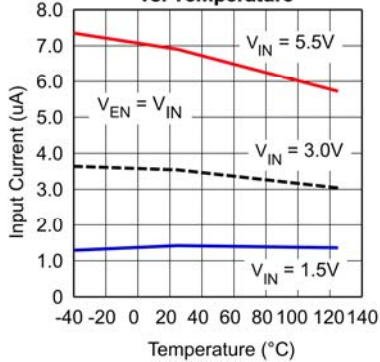

MIC94081/2/3/4/5

Enable Current vs. Temperature

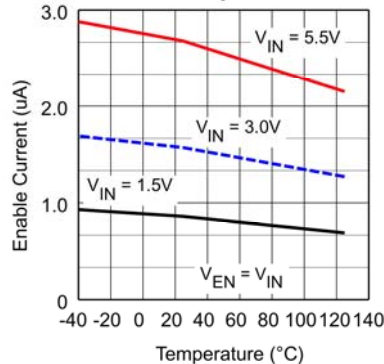

MIC94080/1

T_{ON} Delay vs. Input Voltage

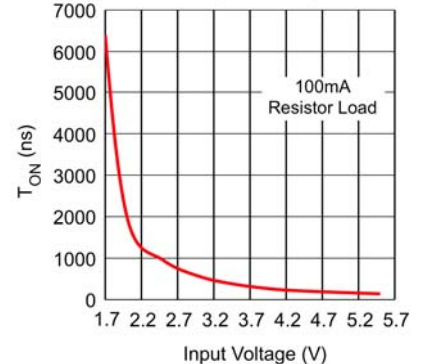

Typical Characteristics

MIC94082/3

T_{ON} Delay vs. Input Voltage

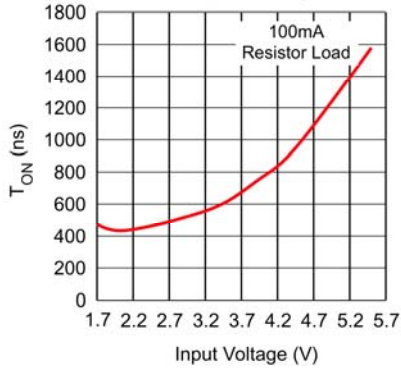

MIC94080/1

Rise Time vs. Input Voltage

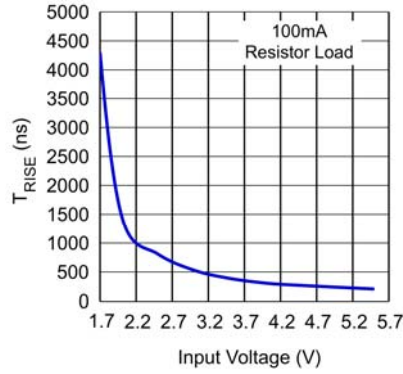

MIC94082/3

Rise Time vs. Input Voltage

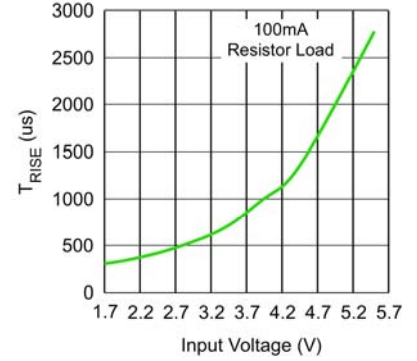

MIC94084/5

T_{ON} Delay vs. Input Voltage

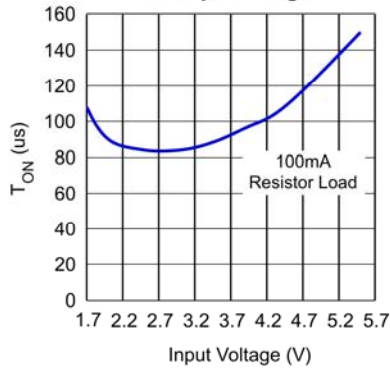

MIC94084/5

Rise Time vs. Input Voltage

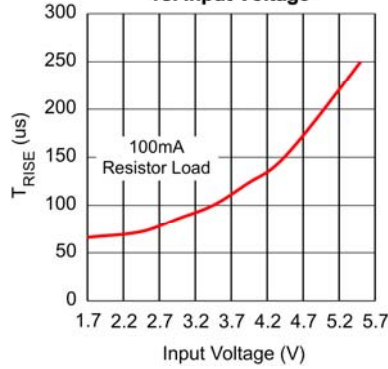

MIC94080/1/2/3/4/5

T_{OFF} Delay vs. Input Voltage

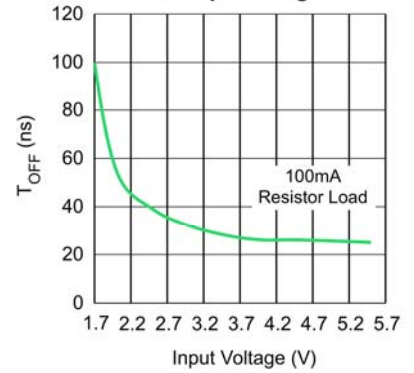

MIC94080/1/2/3/4/5

Fall Time vs. Input Voltage

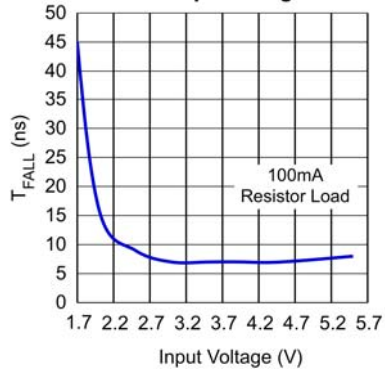

Functional Characteristics

MIC94080

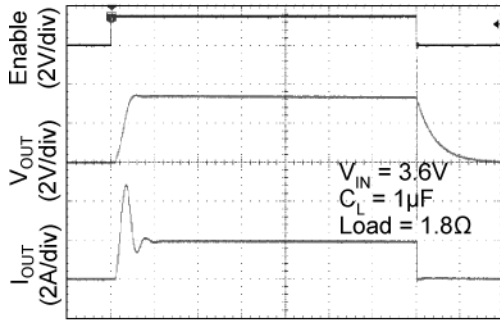

TIME (4μs/div)

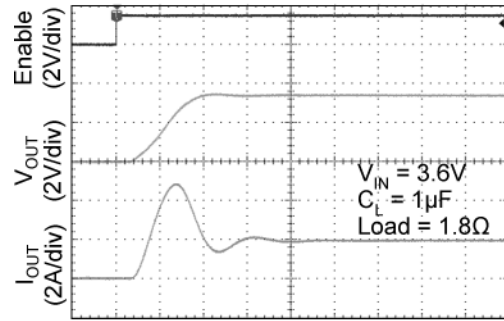

TIME (1μs/div)

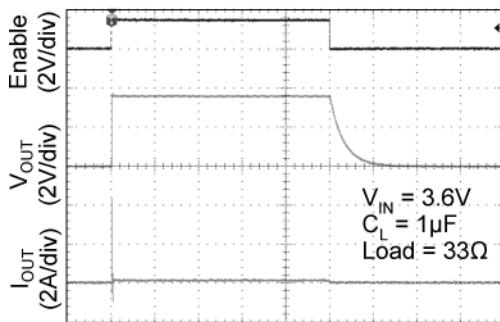

TIME (100μs/div)

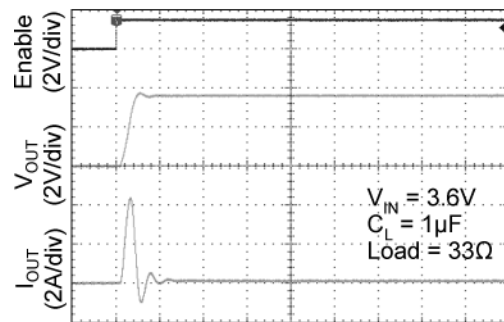

TIME (4μs/div)

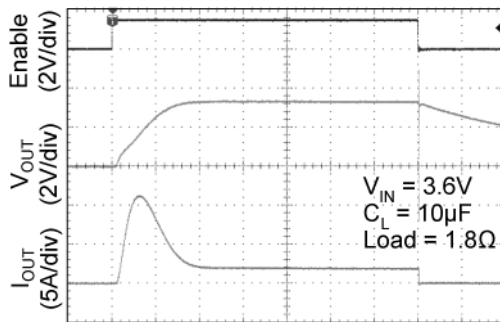

TIME (4μs/div)

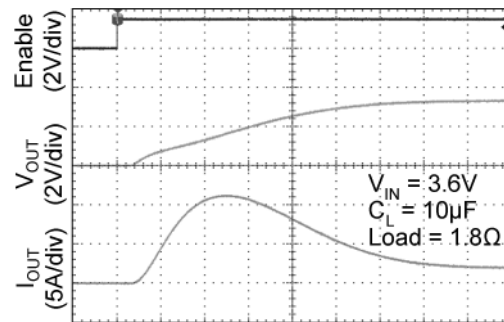

TIME (1μs/div)

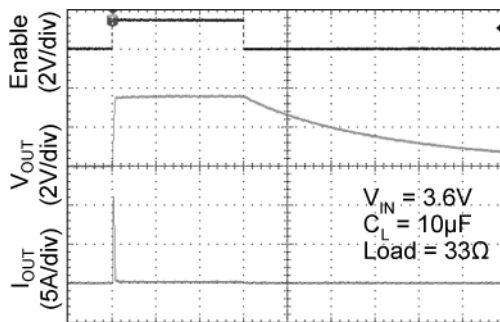

TIME (100μs/div)

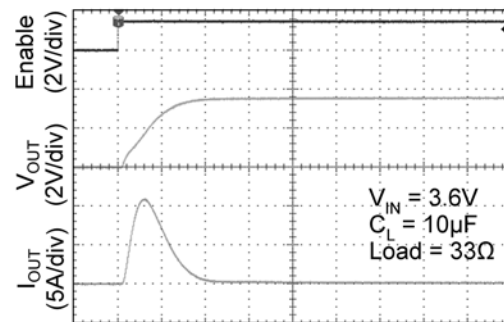

TIME (4μs/div)

MIC94081

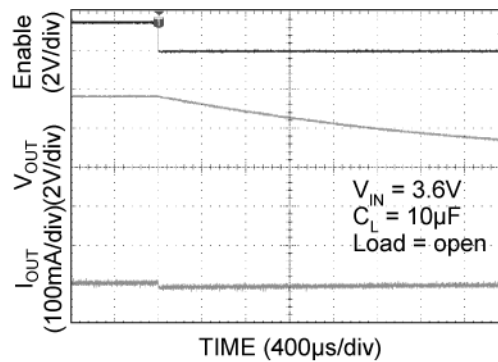
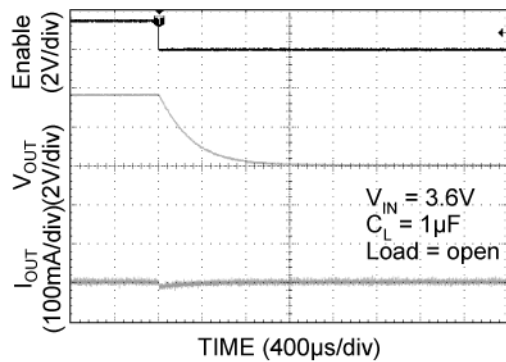
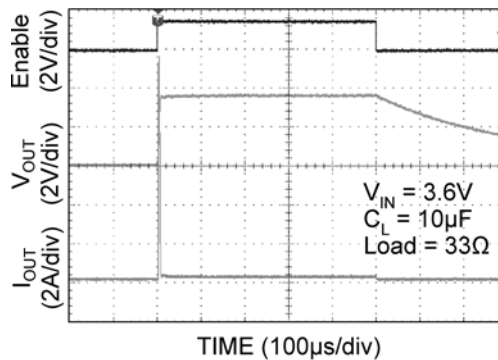
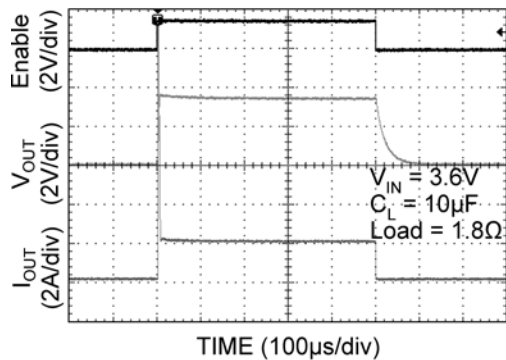
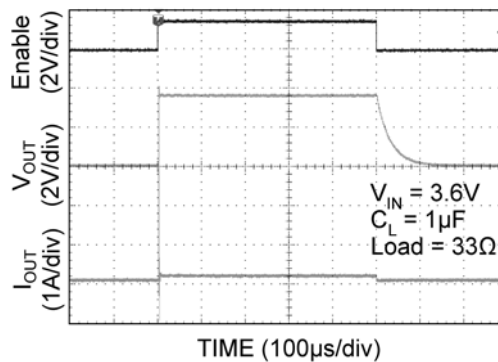
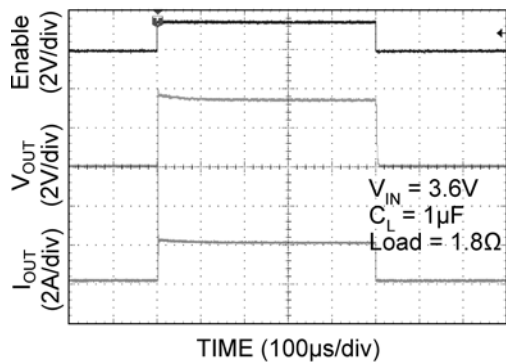

MIC94082

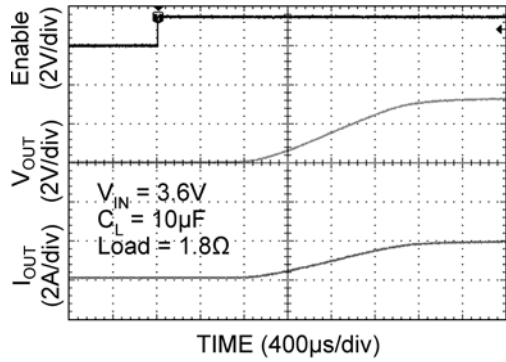
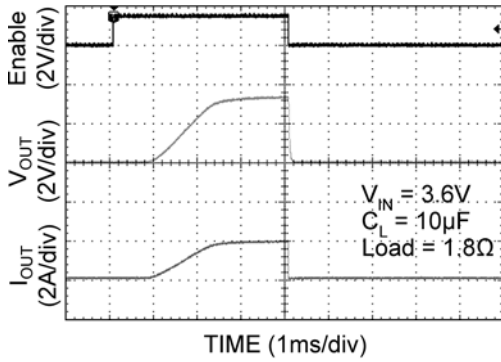
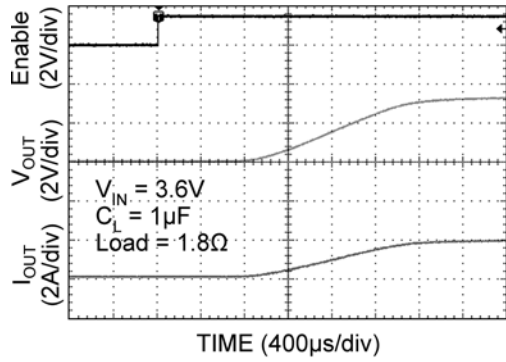
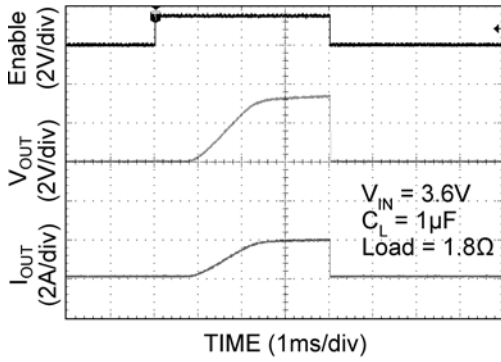
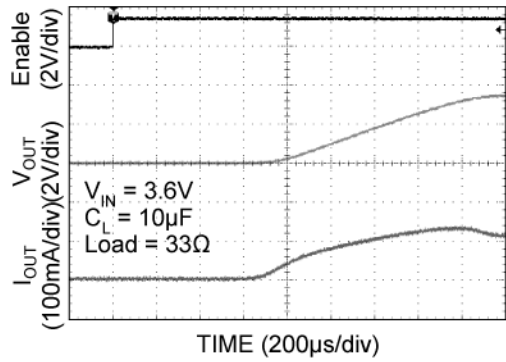
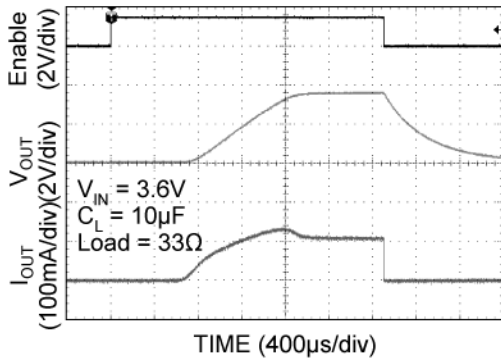
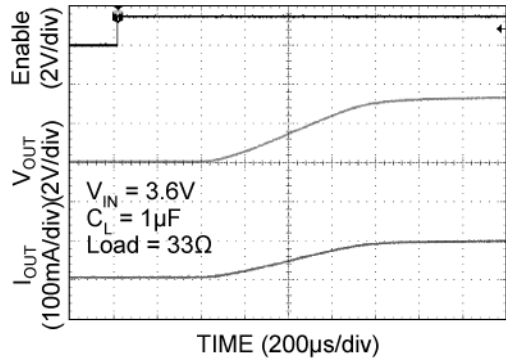
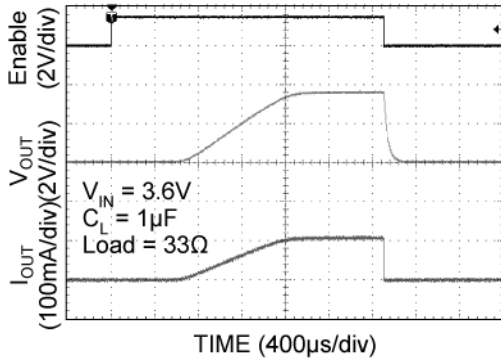

MIC94083

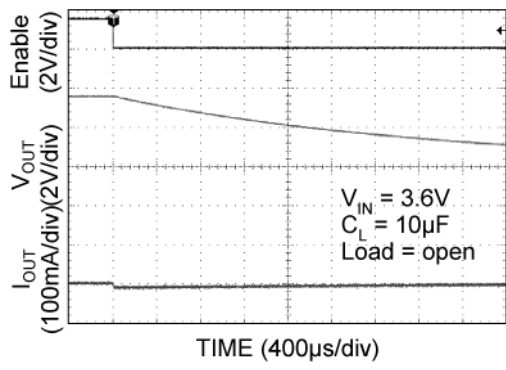
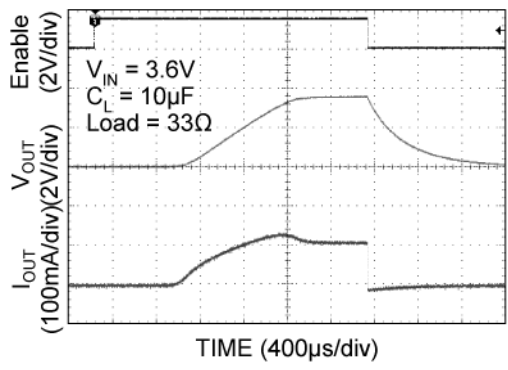
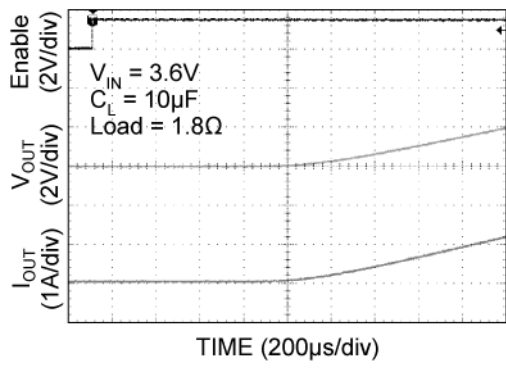
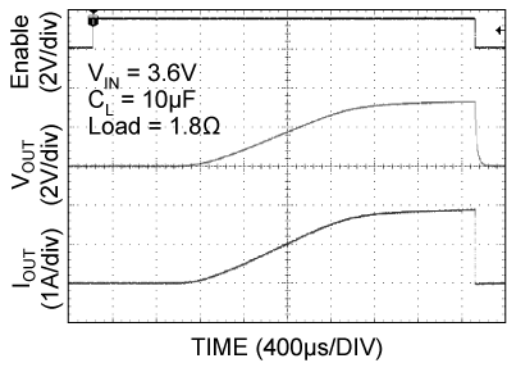
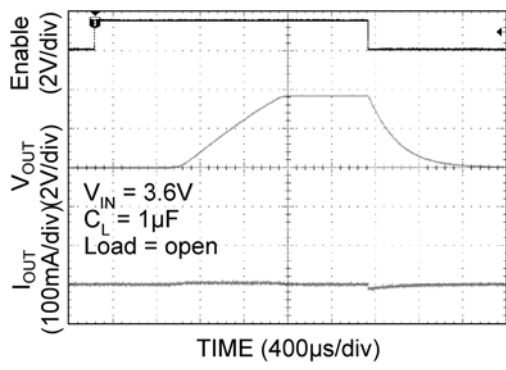
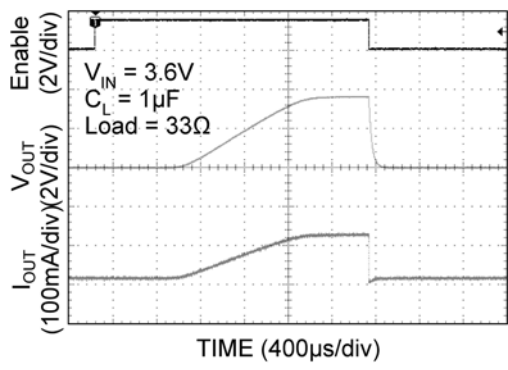
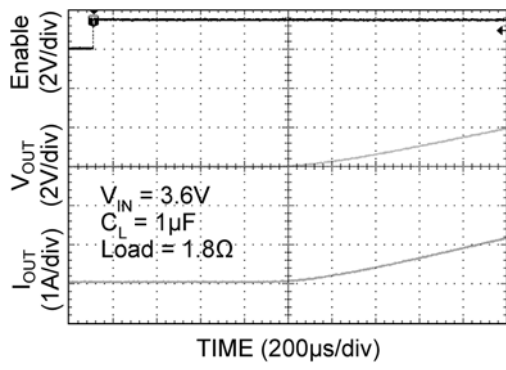
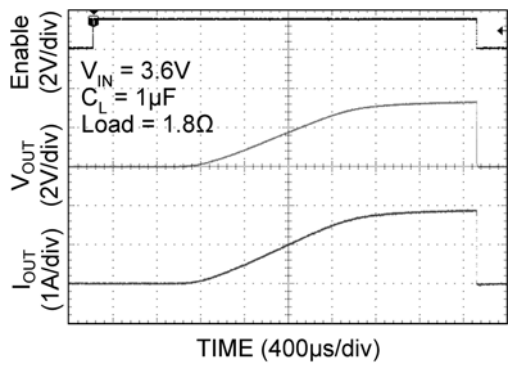

MIC94084

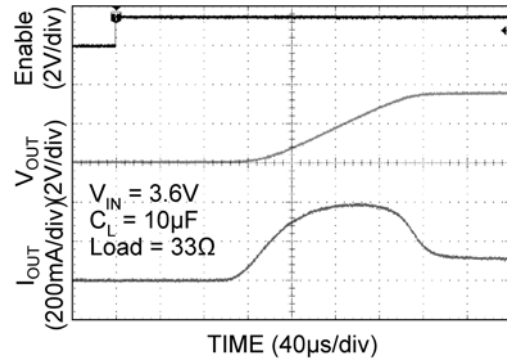
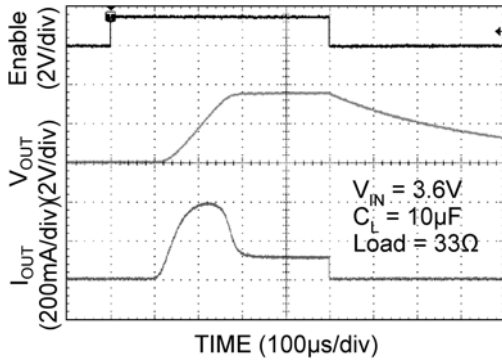
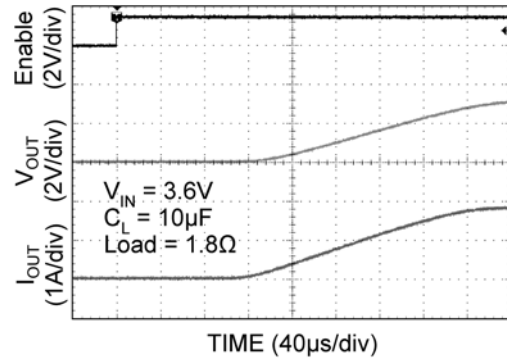
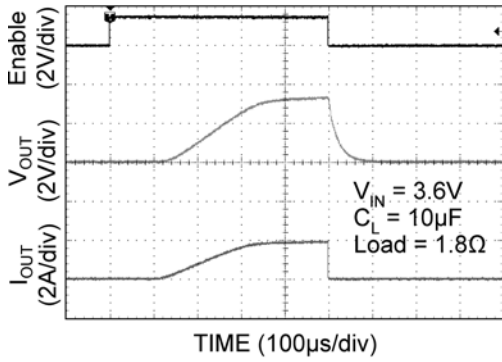
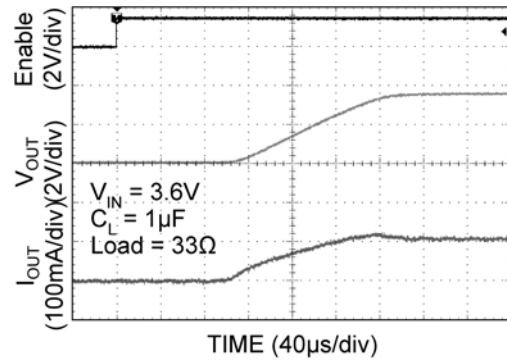
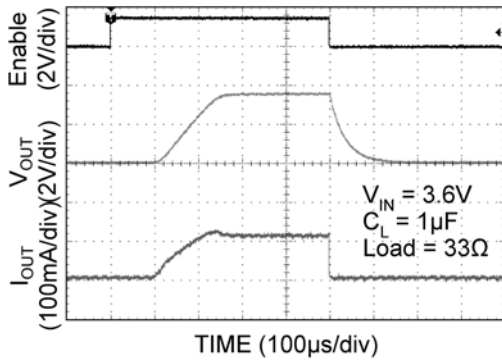
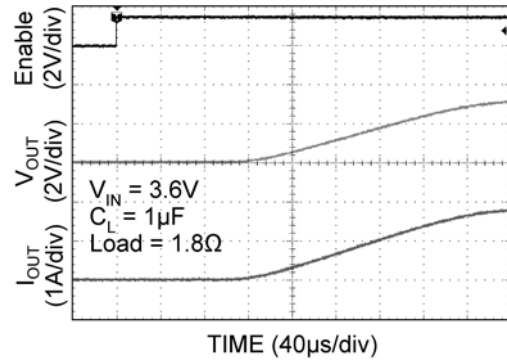
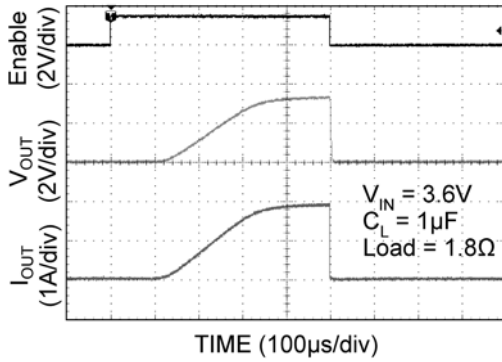

MIC94085

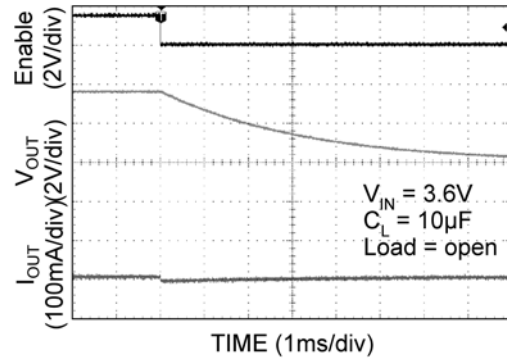
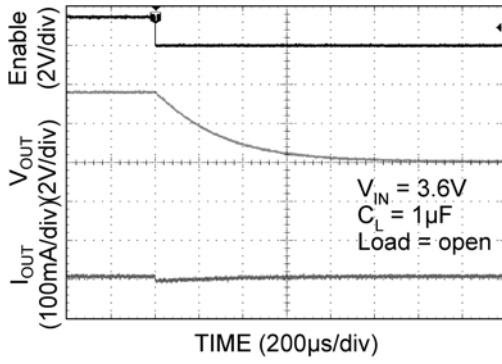
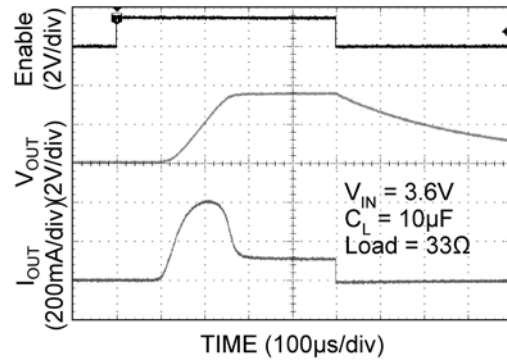
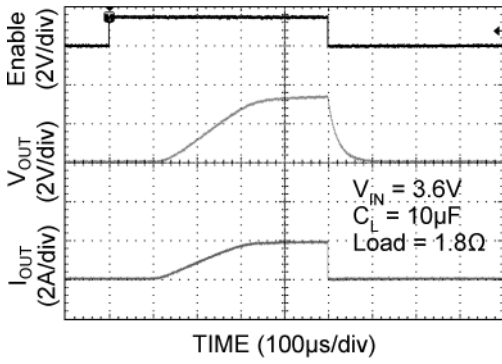
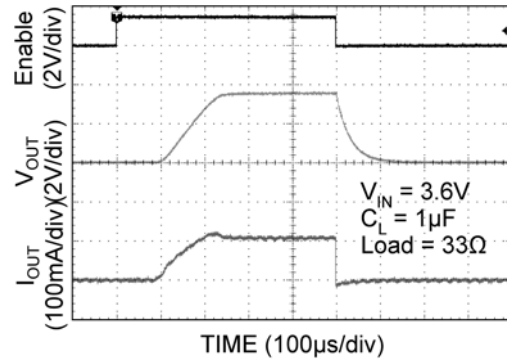
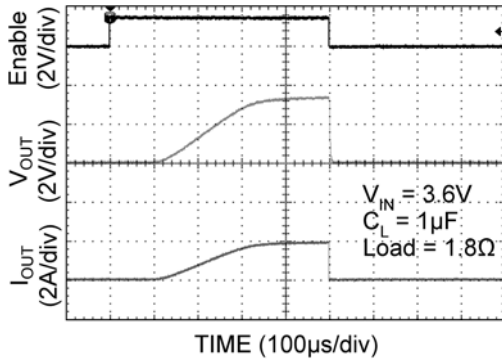

Application Information

Power Switch SOA

The safe operating area (SOA) curve represents the boundary of maximum safe operating current and maximum safe operating junction temperature.

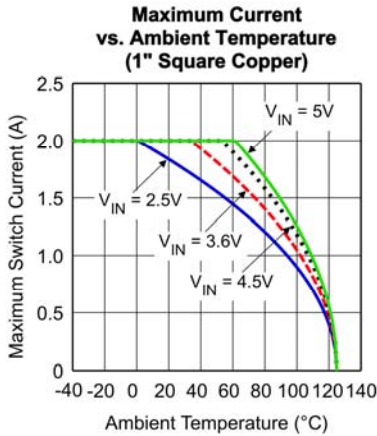

Figure 1. SOA Graph

The curves above show the SOA for various V_{IN} 's mounted on a typical 1 layer, 1 square inch copper board.

Power Dissipation Considerations

As with all power switches, the current rating of the switch is limited mostly by the thermal properties of the package and the PCB it is mounted on. There is a simple ohms law type relationship between thermal resistance, power dissipation and temperature, which are analogous to an electrical circuit:

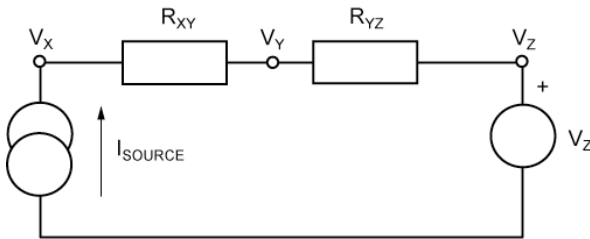

Figure 2. Simple Electrical Circuit

From this simple circuit we can calculate V_X if we know I_{SOURCE} , V_Z and the resistor values, R_{XY} and R_{YZ} using the equation:

$$V_X = I_{SOURCE} \cdot (R_{XY} + R_{YZ}) + V_Z$$

Thermal circuits can be considered using these same rules and can be drawn similarly by replacing current sources with power dissipation (in Watts), resistance with thermal resistance (in °C/W) and voltage sources with temperature (in °C).

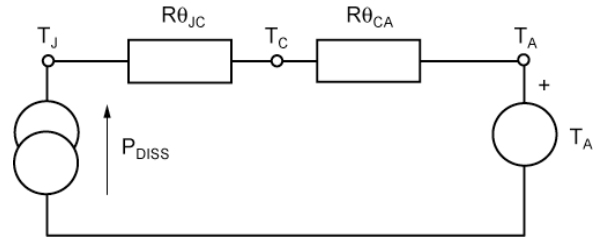

Figure 3. Simple Thermal Circuit

Now replacing the variables in the equation for V_X , we can find the junction temperature (T_J) from power dissipation, ambient temperature and the known thermal resistance of the PCB ($R_{\theta_{CA}}$) and the package ($R_{\theta_{JC}}$).

$$T_J = P_{DISS} \times (R_{\theta_{JC}} + R_{\theta_{CA}}) + T_A$$

P_{DISS} is calculated as $I_{SWITCH}^2 \times R_{SWmax}$. $R_{\theta_{JC}}$ is found in the operating ratings section of the datasheet and $R_{\theta_{CA}}$ (the PCB thermal resistance) values for various PCB copper areas is discussed in the document "Designing with Low Dropout Voltage Regulators" available from the Micrel website (LDO Application Hints).

Example:

A switch is intended to drive a 1A load and is placed on a printed circuit board which has a ground plane area of at least 25mm by 25mm (625mm²). The Voltage source is a Li-ion battery with a lower operating threshold of 3V and the ambient temperature of the assembly can be up to 50°C.

Summary of variables:

- $I_{SW} = 1A$
- $V_{IN} = 3V \text{ to } 4.2V$
- $T_A = 50^\circ C$
- $R_{\theta_{JC}} = 85^\circ C/W$
- $R_{\theta_{CA}} = 53^\circ C/W$ Read from Graph in Figure 4

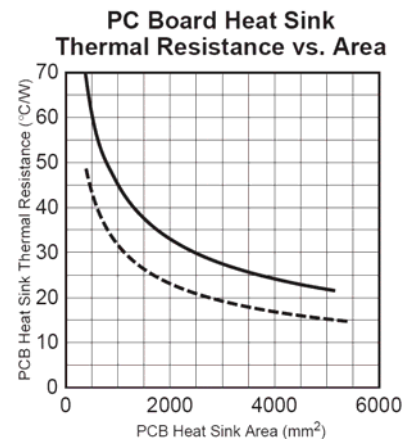

Figure 4. Excerpt from the LDO Book

$$P_{DISS} = I_{SW}^2 \times R_{SWmax}$$

The worst case switch resistance (R_{SWmax}) at the lowest V_{IN} of 3V is not available in the datasheet, so the next lower value of V_{IN} is used.

$$R_{SWmax} @ 2.5v = 200m\Omega$$

If this were a figure for worst case R_{SWmax} for 25°C, an additional consideration is to allow for the maximum junction temperature of 125°C, the actual worst case

resistance in this case can be 30% higher (See R_{DSON} variance vs. temperature graph). However, 200m Ω is the maximum over temperature.

Therefore:

$$T_J = I^2 \times 0.2 \times (85+53) + 50$$

$$T_J = 78^\circ\text{C}$$

This is below the maximum 125°C.

Package Information

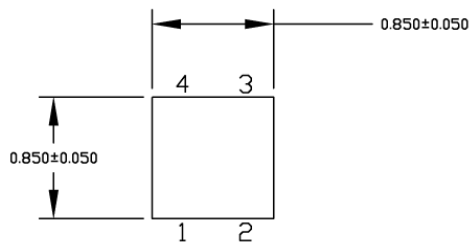

TOP VIEW

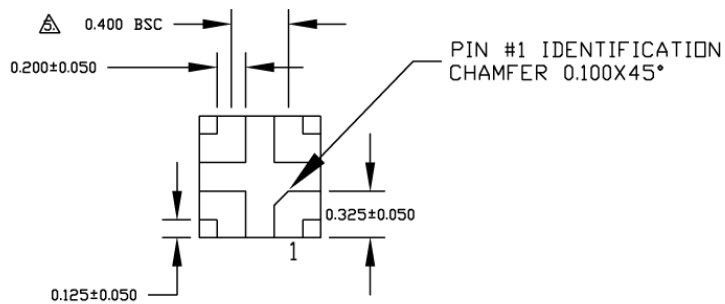

BOTTOM VIEW

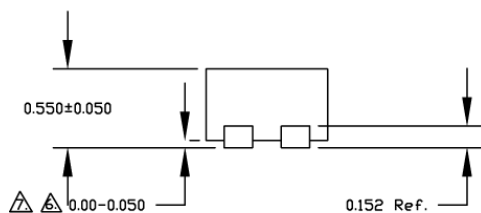

SIDE VIEW

NOTE:

1. ALL DIMENSIONS ARE IN MILLIMETERS.
2. MAX. PACKAGE WARPAGE IS 0.05 mm.
3. MAXIMUM ALLOWABLE BURRS IS 0.076 mm IN ALL DIRECTIONS.
4. PIN #1 ID ON TOP WILL BE LASER/INK MARKED.
- ④ DIMENSION APPLIES TO METALIZED TERMINAL AND IS MEASURED BETWEEN 0.20 AND 0.25 mm FROM TERMINAL TIP.
- ⑤ APPLIED ONLY FOR TERMINALS.
- ⑥ APPLIED FOR EXPOSED PAD AND TERMINALS.

4-Pin (0.85mm x 0.85mm) Thin MLF® (FT)

Recommended Land Pattern

LP # TMLF085085D-4LD-LP-9
 All units are in mm
 Tolerance ± 0.05 if not noted

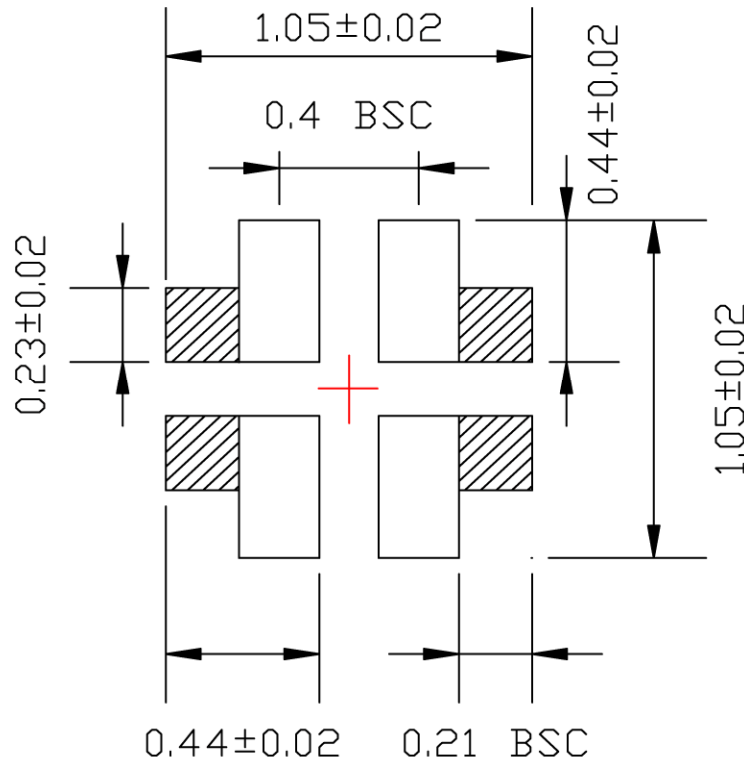

Disclaimer: This is only a recommendation based on information available to Micrel from its suppliers. Actual land pattern may have to be significantly different due to various materials and processes used in PCB assembly. Micrel makes no representation or warranty of performance based on the recommended land pattern."

4-Pin (0.85mm x 0.85mm) Thin MLF[®] (FT)

MICREL, INC. 2180 FORTUNE DRIVE SAN JOSE, CA 95131 USA
 TEL +1 (408) 944-0800 FAX +1 (408) 474-1000 WEB <http://www.micrel.com>

Micrel makes no representations or warranties with respect to the accuracy or completeness of the information furnished in this data sheet. This information is not intended as a warranty and Micrel does not assume responsibility for its use. Micrel reserves the right to change circuitry, specifications and descriptions at any time without notice. No license, whether express, implied, arising by estoppel or otherwise, to any intellectual property rights is granted by this document. Except as provided in Micrel's terms and conditions of sale for such products, Micrel assumes no liability whatsoever, and Micrel disclaims any express or implied warranty relating to the sale and/or use of Micrel products including liability or warranties relating to fitness for a particular purpose, merchantability, or infringement of any patent, copyright or other intellectual property right.

Micrel Products are not designed or authorized for use as components in life support appliances, devices or systems where malfunction of a product can reasonably be expected to result in personal injury. Life support devices or systems are devices or systems that (a) are intended for surgical implant into the body or (b) support or sustain life, and whose failure to perform can be reasonably expected to result in a significant injury to the user. A Purchaser's use or sale of Micrel Products for use in life support appliances, devices or systems is a Purchaser's own risk and Purchaser agrees to fully indemnify Micrel for any damages resulting from such use or sale.

© 2008 Micrel, Incorporated.