



Chipsmall Limited consists of a professional team with an average of over 10 year of expertise in the distribution of electronic components. Based in Hongkong, we have already established firm and mutual-benefit business relationships with customers from,Europe,America and south Asia,supplying obsolete and hard-to-find components to meet their specific needs.

With the principle of "Quality Parts,Customers Priority,Honest Operation,and Considerate Service",our business mainly focus on the distribution of electronic components. Line cards we deal with include Microchip,ALPS,ROHM,Xilinx,Pulse,ON,Everlight and Freescale. Main products comprise IC,Modules,Potentiometer,IC Socket,Relay,Connector.Our parts cover such applications as commercial,industrial, and automotives areas.

We are looking forward to setting up business relationship with you and hope to provide you with the best service and solution. Let us make a better world for our industry!



Contact us

Tel: +86-755-8981 8866 Fax: +86-755-8427 6832

Email & Skype: info@chipsmall.com Web: www.chipsmall.com

Address: A1208, Overseas Decoration Building, #122 Zhenhua RD., Futian, Shenzhen, China





MICRF300

100MHz to 1000MHz, 1.8 to 3.6V,
Low-Noise Amplifier with Shutdown

General Description

The MICRF300 is a low-noise amplifier (LNA) with low-power shutdown mode, which operates over the 100MHz to 1000MHz frequency band. The device is targeted for low-power, low-data rate applications at 315/433MHz, achieving a low 1.2dB noise figure with 18dB of gain, helping to improve receiver noise figure and sensitivity. The device also performs well at 868/915MHz, achieving 13dB of gain and a noise figure of 1.7dB. The device requires a simple input matching network and output matching network to optimize performance for the desired frequency band.

The MICRF300 operates over the 1.8V to 3.6V voltage range. Consuming a low 2.5mA of supply current during operation and a typical 50nA of shutdown current, the MICRF300 is an ideal solution for battery powered equipment. The device is available in 6-pin SC70 package and is rated to operate over the -40°C to +125°C temperature range.

Features

- 1.8V to 3.6V supply voltage range
- 2.5mA operating supply current
- 1µA (Max) shutdown current over temperature
- 18.3dB gain at 315MHz/433.92MHz
- 1.15dB noise figure at 315MHz/433.92MHz
- -25dBm input P_{1dB} compression point at 433.92MHz
- -40°C to +125°C operating temperature range
- Small 6-pin SC70 package

Applications

- Security systems
- Remote keyless entry (RKE)
- Tire pressure monitoring (TPMS)
- Automated meter reading (AMR)
- Garage door openers (GDO)
- Remote weatherstations

Typical Application Circuit

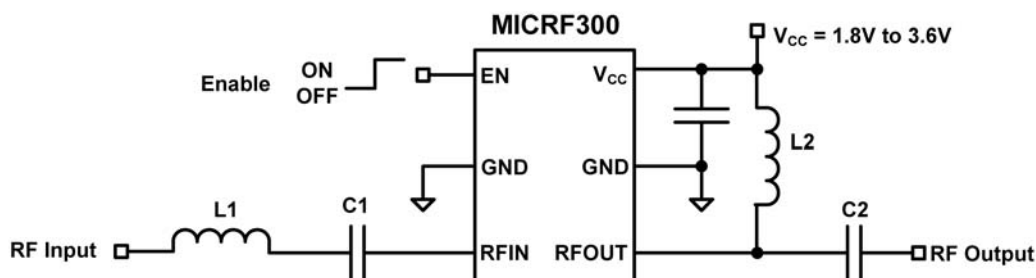

Typical Performance and Matching Component Values

f_{RF} (MHz)	I_{CC} (mA)	Gain (dB)	NF (dB)	IP1dB (dBm)	IIP3 (dBm)	L1 (nH)	C1 (pF)	L2 (nH)	C2 (pF)
315	2.5	18.5	1.15	-26.5	-15	33	1000	47	5.6
433.92	2.5	18.3	1.15	-25	-13	22	1000	33	3.9
900	2.5	13.6	1.7	-21	-10	2.7	270	10	1.8

Ordering Information

Part Number	Temp. Range	Package	Top Mark
MICRF300YC6	-40°C to +125°C	SC70-6	<u>XE1</u>

Notes:

1. Under bar symbol () may not be to scale.

Pin Configuration

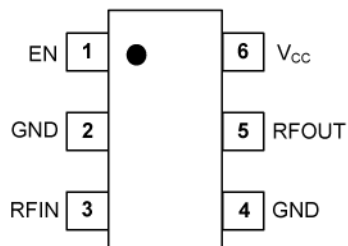

SC70-6 (C6)

Pin Description

Pin Number	Pin Name	Pin Function
1	EN	Enable Logic Input. Logic high enables the part. Logic low disables the part.
2, 4	GND	Ground. Connect to PCB ground plane.
3	RFIN	RF Input. DC blocking and matching network is required.
5	RFOUT	RF Output. Connect a pull-up inductor to the supply and a matching network to the load.
6	V _{CC}	Supply Voltage. Connect a 0.1μF bypass capacitor as close to the pin as possible.

Absolute Maximum Ratings⁽¹⁾

Supply Voltage (V_{CC})	-0.3V to +3.9V
EN Voltage (V_{EN})	-0.3V to $V_{CC} + 0.3V$
Maximum Junction Temperature (T_J)	+150°C
Storage Temperature (T_S)	-65°C to +150°C
Lead Temperature (soldering, 10sec.)	+260°C
Maximum Input Power	+10dBm (50Ω source)
ESD Rating ⁽³⁾	
HBM	1.5kV
MM	100V

Operating Ratings⁽²⁾

Supply Voltage (V_{CC})	+1.8V to +3.6V
EN Voltage (V_{EN})	0V to V_{CC}
Ambient Temperature (T_A)	-40°C to +125°C
RFIN DC voltage	AC coupled
Frequency Range	100MHz to 1000MHz
Thermal Resistance (θ_{JA})	260°C/W

ELECTRICAL CHARACTERISTICS TABLE⁽⁴⁾

$V_{CC} = +2.7V$, $T_A = +25^\circ C$, bold values indicate $-40^\circ C \leq T_A \leq +125^\circ C$, unless noted.

Parameter	Condition	Min	Typ	Max	Units
Shutdown Current (I_{SHDN})	$V_{EN} = 0V$, $T_A = +25^\circ C$		0.05	0.5	μA
	$V_{EN} = 0V$			1	
Operating Supply Current (I_{CC})	$V_{EN} = V_{CC}$		2.5	4	mA
EN Logic-Low (V_{IL})				0.2	V
EN Logic-High (V_{IH})		1.2			V
EN Input Current	$V_{EN} = 0.2V$		20		nA
	$V_{EN} = 2.2V$		28	40	μA
Gain	$f_{RF} = 315MHz$		18.5		dB
	$f_{RF} = 433.92MHz$	14	18.3		
	$f_{RF} = 900MHz$	10	13.6		
Noise Figure (NF)	$f_{RF} = 315MHz$		1.15		dB
	$f_{RF} = 433.92MHz$		1.15		
	$f_{RF} = 900MHz$		1.7		
Input 3 rd Order Intercept Point (IIP3) (Note 5)	$f_{RF} = 315MHz$		-15		dBm
	$f_{RF} = 433.92MHz$		-13		
	$f_{RF} = 900MHz$		-10		
Input 1dB compression (P_{1dB})	$f_{RF} = 315MHz$		-27		dBm
	$f_{RF} = 433.92MHz$		-25		
	$f_{RF} = 900MHz$		-21		
Enable Time	$f_{RF} = 315MHz$; 433.92MHz		10		μs
Disable Time	$f_{RF} = 315MHz$; 433.92MHz		10		μs

Notes:

- Exceeding the absolute maximum rating may damage the device.
- The device is not guaranteed to function outside its operating rating.
- Devices are ESD sensitive. Handling precautions recommended. Human body model, 1.5kΩ in series with 100pF.
- Specification for packaged product only.
- IIP3 is measured with two tones located at 433MHz and 433.92MHz or 899MHz and 900MHz with -40dBm/tone.

Typical Characteristics

Supply Current vs Supply Voltage

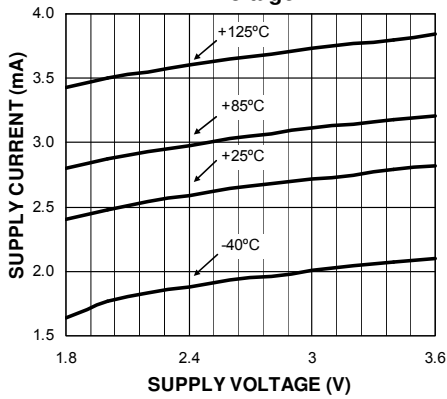

Supply Current vs Enable Voltage

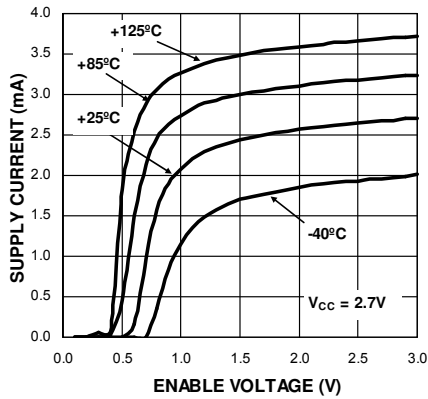

Enable Input Current vs Enable Voltage

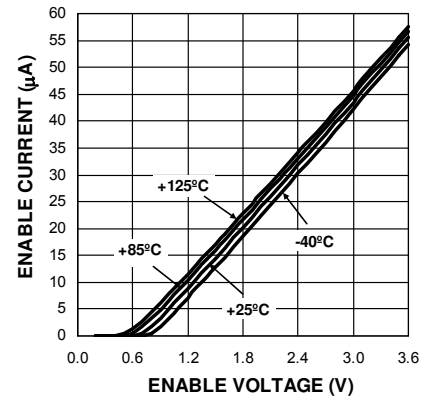

IIP3 vs Supply Voltage
 $f_{RF} = 315\text{MHz}$

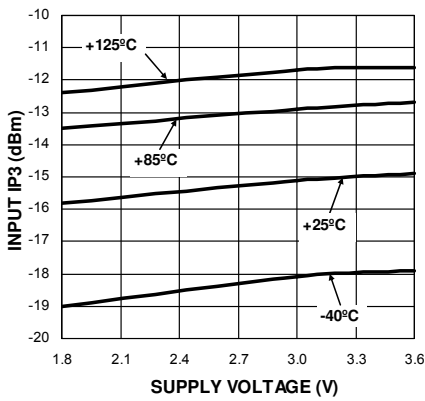

Input P1dB vs Supply Voltage
 $f_{RF} = 315\text{MHz}$

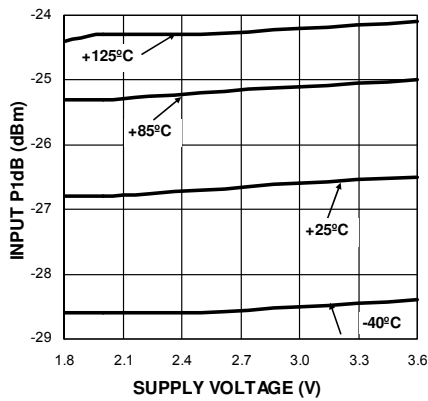

Gain vs Supply Voltage
 $f_{RF} = 315\text{MHz}$

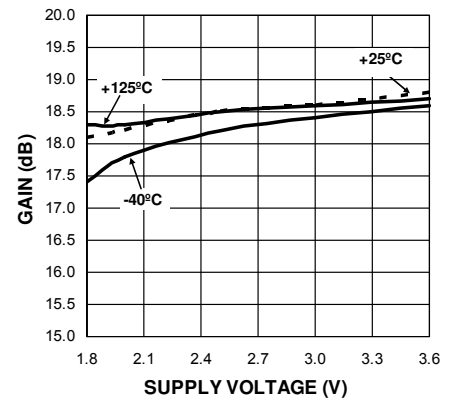

IIP3 vs Supply Voltage
 $f_{RF} = 433.92\text{MHz}$

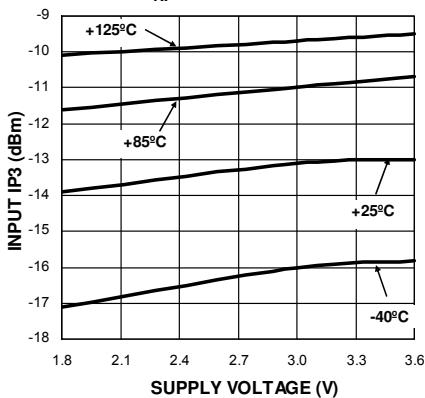

Input P1dB vs Supply Voltage
 $f_{RF} = 433.92\text{MHz}$

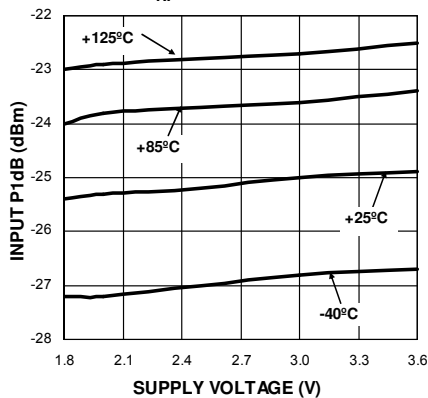

Gain vs Supply Voltage
 $f_{RF} = 433.92\text{MHz}$

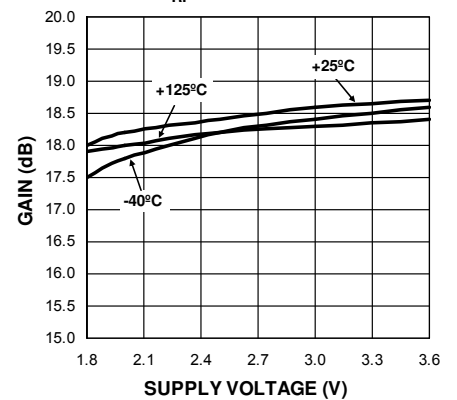

Typical Characteristics (Continued)

IIP3 vs Supply Voltage
 $f_{RF} = 900\text{MHz}$

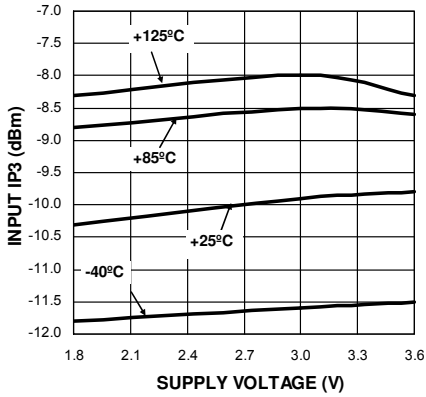

Input P1dB vs Supply Voltage
 $f_{RF} = 900\text{MHz}$

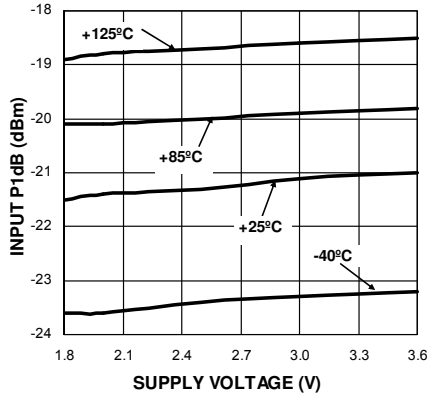

Gain vs Supply Voltage
 $f_{RF} = 900\text{MHz}$

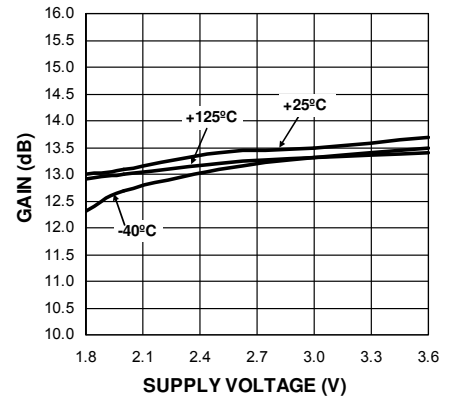

S-Parameters vs Frequency
 $f_{RF} = 315\text{MHz}$ (matched)

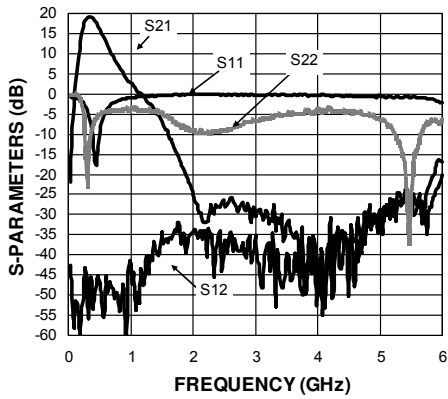

S-Parameters vs Frequency
 $f_{RF} = 433\text{MHz}$ (matched)

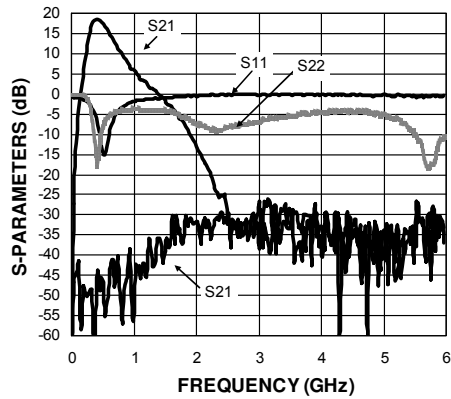

S-Parameters vs Frequency
 $f_{RF} = 900\text{MHz}$ (matched)

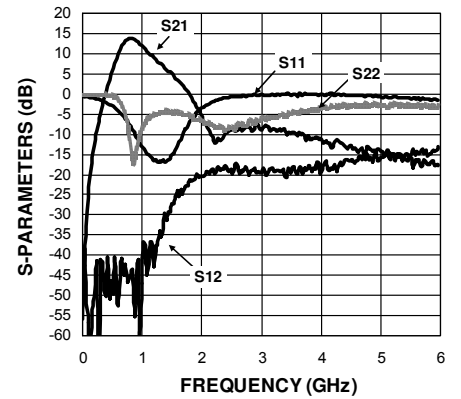

S-Parameters vs Frequency
 $f_{RF} = 315\text{MHz}$ (matched)

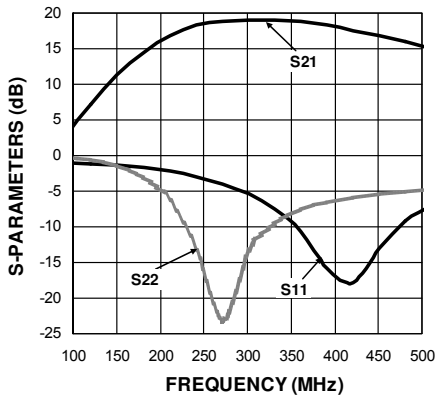

S-Parameters vs Frequency
 $f_{RF} = 433.92\text{MHz}$ (matched)

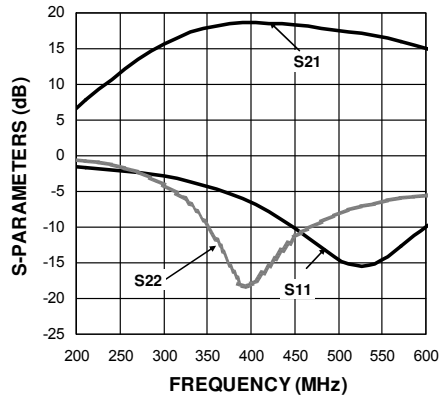

S-Parameters vs Frequency
 $f_{RF} = 900\text{MHz}$ (matched)

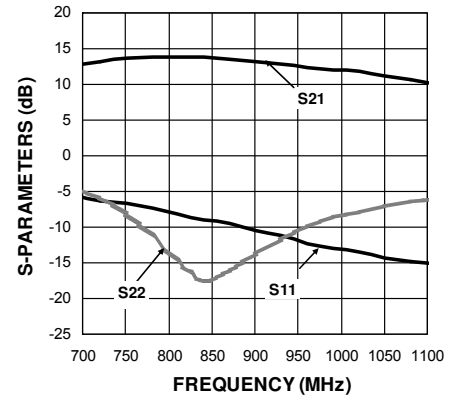

Typical Characteristics (Continued)

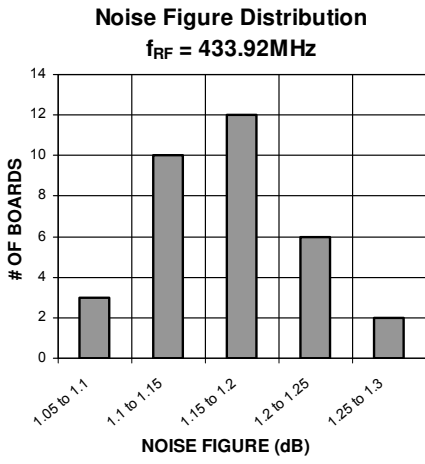

Functional Description

The MICRF300 is a low-noise amplifier (LNA) which operates over the 100 to 1000MHz frequency range. The device operates from a 1.8V to 3.6V voltage supply, where it consumes 2.5mA of supply current during operation, and 1 μ A (max) of current in shutdown. A simple LC input matching network is required to optimize the device for best noise figure. A simple LC network is required to bias the output stage and match the output to the following stage. Recommended matching networks have been provided for 315MHz, 433.92MHz and 900MHz. See *Evaluation Board and Bill of Materials* for recommended component values. See Figure 1 for Block Diagram of the MICRF300.

Input Matching

The RF input pin, RFIN (Pin 3) is directly connected to the base of the RF input device. In normal operation, the DC voltage of this pin is one diode above GND. The MICRF300 requires an input matching network for optimal noise figure, gain and linearity. A series inductor and a DC-blocking capacitor are required to implement this network. A high-Q, wire-wound type inductor is recommended for lowest noise figure at 315MHz and 433.92MHz. A standard multi-layer ceramic inductor can be used, but the noise figure degrades by 0.2 dB. At 900MHz, a standard multi-layer ceramic inductor may be used as the inductance value is very low, and the Q does not make a measurable difference. See recommended component values in the *Typical Performance and Matching Component Values* section of the data sheet.

Functional Diagram

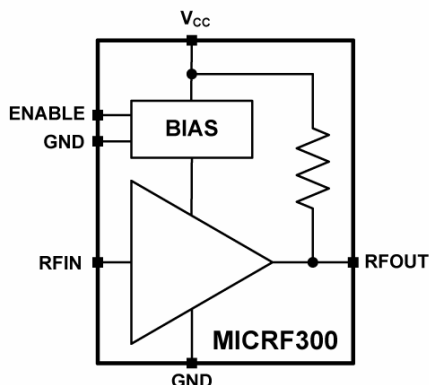

Figure 1: Block Diagram

Output Bias and Matching

The output stage has an internal pull-up resistor of 250 Ω . To resonate out any parasitic capacitance and to increase output swing capability, a multi-layer ceramic inductor should be connected from the RF output, RFOUT (Pin 5) pin to V_{CC} . See recommended component values in the *Typical Performance and Matching Component Values* table of the data sheet.

Enable

The MICRF300 features a logic-level enable, EN (Pin 1). A logic-level low disables the device. A logic-level High enables the device. The value of the input DC-blocking capacitor will affect the enable and disable time of the device.

Power Supply Bypassing

Minimum supply bypassing is needed on PCB board to filter out AC fluctuations in supply voltage. It is achieved by placing a 0.1 μ F capacitor as close as possible between the V_{CC} (Pin 6) and GND (Pins 2 and 4). Refer to the MICRF300 Evaluation Board for recommend layout.

Package Information

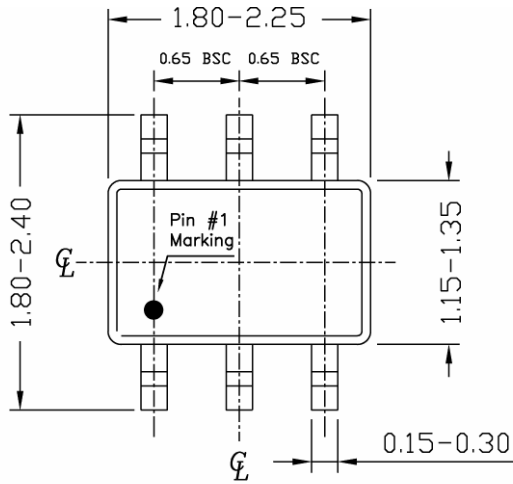

TOP VIEW

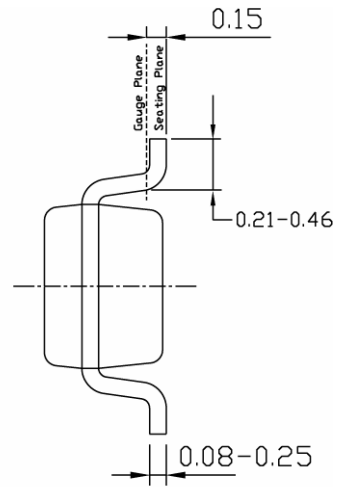

END VIEW

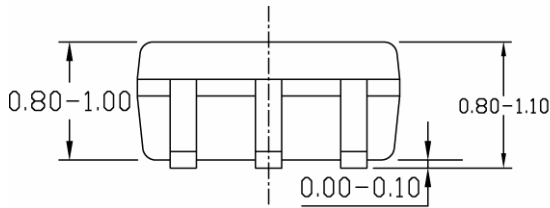

SIDE VIEW

SC70-6 (C6)

MICREL, INC. 2180 FORTUNE DRIVE SAN JOSE, CA 95131 USA
 TEL +1 (408) 944-0800 FAX +1 (408) 474-1000 WEB <http://www.micrel.com>

Micrel makes no representations or warranties with respect to the accuracy or completeness of the information furnished in this data sheet. This information is not intended as a warranty and Micrel does not assume responsibility for its use. Micrel reserves the right to change circuitry, specifications and descriptions at any time without notice. No license, whether express, implied, arising by estoppel or otherwise, to any intellectual property rights is granted by this document. Except as provided in Micrel's terms and conditions of sale for such products, Micrel assumes no liability whatsoever, and Micrel disclaims any express or implied warranty relating to the sale and/or use of Micrel products including liability or warranties relating to fitness for a particular purpose, merchantability, or infringement of any patent, copyright or other intellectual property right.

Micrel Products are not designed or authorized for use as components in life support appliances, devices or systems where malfunction of a product can reasonably be expected to result in personal injury. Life support devices or systems are devices or systems that (a) are intended for surgical implant into the body or (b) support or sustain life, and whose failure to perform can be reasonably expected to result in a significant injury to the user. A Purchaser's use or sale of Micrel Products for use in life support appliances, devices or systems is a Purchaser's own risk and Purchaser agrees to fully indemnify Micrel for any damages resulting from such use or sale.

© 2012 Micrel, Incorporated.