



Chipsmall Limited consists of a professional team with an average of over 10 year of expertise in the distribution of electronic components. Based in Hongkong, we have already established firm and mutual-benefit business relationships with customers from,Europe,America and south Asia,supplying obsolete and hard-to-find components to meet their specific needs.

With the principle of “Quality Parts,Customers Priority,Honest Operation,and Considerate Service”,our business mainly focus on the distribution of electronic components. Line cards we deal with include Microchip,ALPS,ROHM,Xilinx,Pulse,ON,Everlight and Freescale. Main products comprise IC,Modules,Potentiometer,IC Socket,Relay,Connector.Our parts cover such applications as commercial,industrial, and automotives areas.

We are looking forward to setting up business relationship with you and hope to provide you with the best service and solution. Let us make a better world for our industry!



Contact us

Tel: +86-755-8981 8866 Fax: +86-755-8427 6832

Email & Skype: info@chipsmall.com Web: www.chipsmall.com

Address: A1208, Overseas Decoration Building, #122 Zhenhua RD., Futian, Shenzhen, China





mikromedia™

for STM32®

Compact multimedia development system rich with on-board peripherals for all-round development on **STM32F207VGT6** and **STM32F407VGT6** devices



TO OUR VALUED CUSTOMERS

I want to express my thanks to you for being interested in our products and for having confidence in MikroElektronika.

The primary aim of our company is to design and produce high quality electronic products and to constantly improve the performance thereof in order to better suit your needs.

A white handwritten signature in cursive script, appearing to read 'N. Matic', is positioned on the right side of the page.

Nebojsa Matic
General Manager

Table of Contents

Introduction to mikromedia for STM32®	4	Programming with mikroProg™ programmer	18
Package contains	5	mikroProg Suite™ for ARM® software	19
Key features	6	Programming with ST-LINK V2 programmer	20
System specifications	7	4. Reset button	22
1. Power supply	8	5. Oscillators	24
USB power supply	8	6. MicroSD card slot	26
Battery power supply	8	7. Touch screen	28
2. Key microcontrollers features	10	8. Audio module	30
STM32F207VGT6	10	9. USB connection	32
STM32F407VGT6	11	10. Accelerometer	34
3. Programming the microcontroller	12	11. Flash memory	36
Programming with mikroBootloader	14	12. Pads	38
step 1 - Connecting mikromedia	14	13. Pinout	39
step 2 - Browsing for .hex file	15	14. Dimensions	40
step 3 - Selecting .hex file	15	15. Mikromedia accessories	41
step 4 - Uploading .hex file	16	16. What's next	42
step 5 - Finish upload	17		

Introduction to mikromedia for STM32®

mikromedia for STM32® is a compact development system with lots of on-board peripherals which allow development of devices with multimedia contents. The central part of the system is a 32-bit **STM32F207VGT6** or **STM32F407VGT6** microcontroller. mikromedia for STM32® features integrated modules such as stereo MP3 codec, **TFT 320x240** touch screen display, accelerometer, USB connector, MMC/SD card slot, 8 Mbit flash memory, 2x26 connection pads and other. It comes pre-programmed with USB bootloader, but can also be programmed with external programmers, such as mikroProg™ for STM32® or ST-LINK. Mikromedia is compact and slim, and perfectly fits in the palm of the hand, which makes it convenient platform for mobile devices.



Package contains



01 Damage resistant protective box

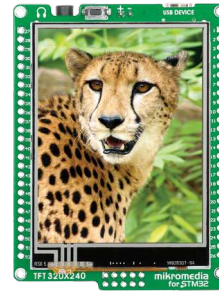

02 mikromedia for STM32® development system



03 User's guide, schematic and pinout



04 USB cable, headers and ST-LINK V2 to mikroProg™ adapter

Key features

- 01 RESET button
- 02 Connection Pads
- 03 TFT 320x240 display
- 04 USB MINI-B connector
- 05 Charge indication LED
- 06 LI-Polymer battery connector
- 07 3.5mm headphone connector
- 08 Power supply regulator
- 09 Crystal oscillator
- 10 VS1053 Stereo mp3 coder/decoder
- 11 STM32F207VGT6 or STM32F407VGT6 microcontroller
- 12 Accelerometer
- 13 Serial flash memory
- 14 microSD card slot
- 15 Power indication LED
- 16 JTAG/SWD programmer connector

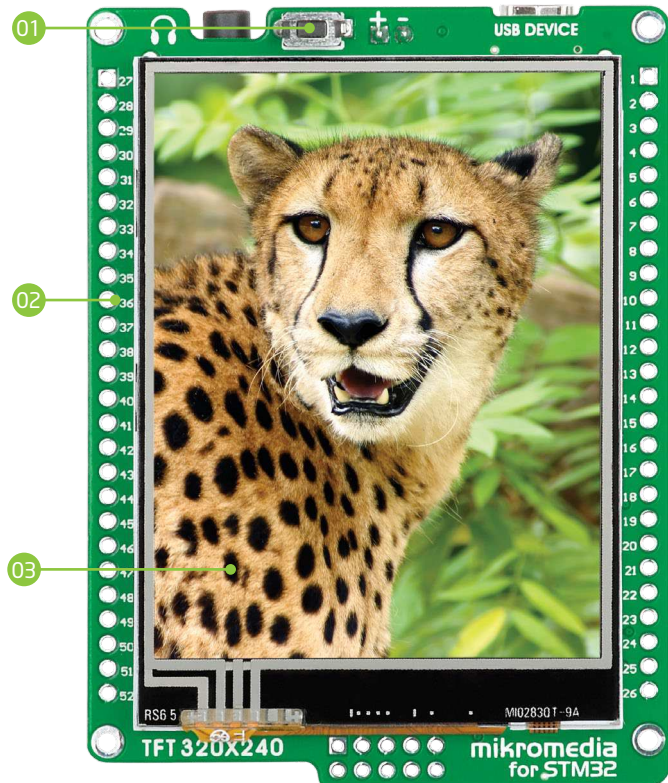

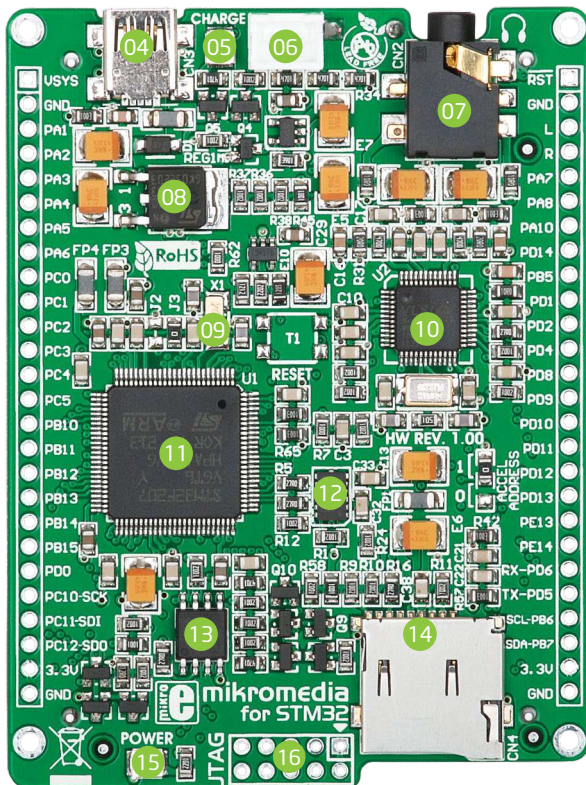

System specification



power supply
Via USB cable (5V DC)



power consumption
46.5 mA with erased MCU
(when on-board modules are inactive)



board dimensions
81.2 x 60.5 mm (3.19 x 2.38 inch)



weight
~45 g (0.10 lbs)



class B product
Product complies with the Class B limit of EN 55022 and can be used in the domestic, residential, commercial and industrial environments.



CAUTION: Electrostatic sensitive device
Permanent damage may occur on devices subjected to high energy electrostatic discharges which readily accumulate on the human body or test equipment and can discharge without detection.

1. Power supply

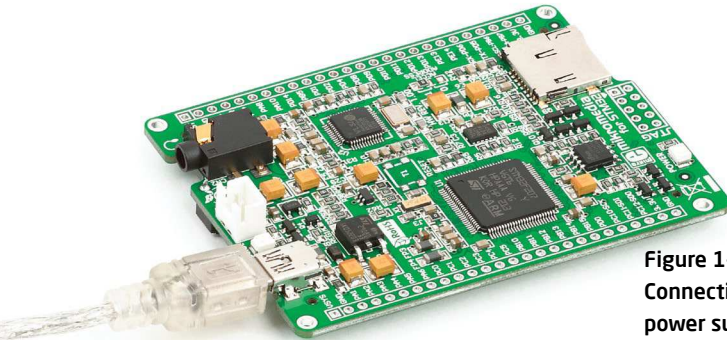

Figure 1-1:
Connecting USB
power supply

USB power supply

You can apply power supply to the board using **Mini-B USB** cable provided with the board. On-board voltage regulators provide the appropriate voltage levels to each component on the board. **Power LED (GREEN)** will indicate the presence of power supply.

Battery power supply

You can also power the board using a **Li-Polymer** battery, via on-board battery connector. On-board battery charger circuit **MCP73832** enables you to charge the battery over a USB connection. **LED diode (RED)** will indicate when the battery is charging. Charging current is ~250mA and charging voltage is 4.2V DC.

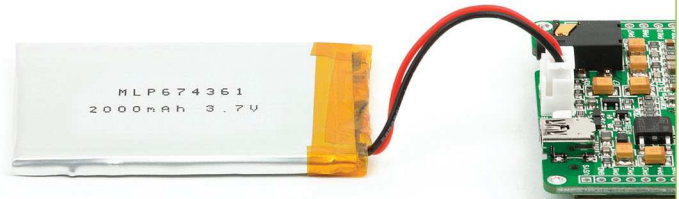

Figure 1-2: Connecting Li-Polymer battery

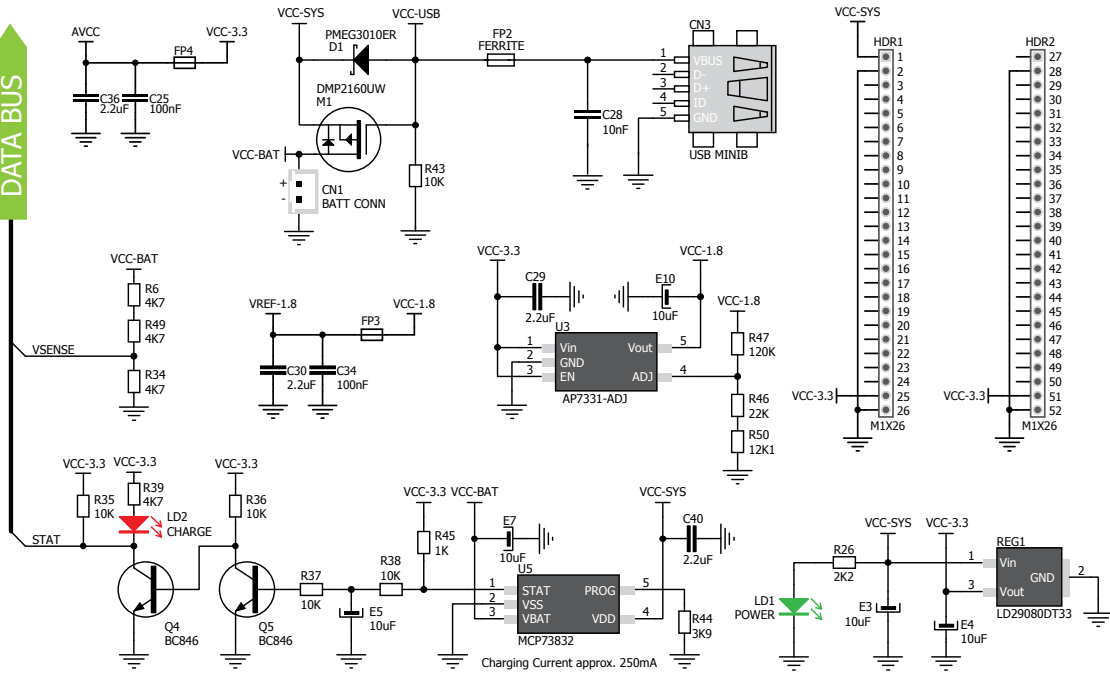

Figure 1-3: Power supply schematic

2. Key microcontrollers features

The mikromedia for STM32[®] M3 development system comes with the **STM32F207VGT6** microcontroller. This high-performance **32-bit** microcontroller with its integrated modules and in combination with other on-board modules is ideal for multimedia applications.

STM32F207VGT6

- 1.25 DMIPS/MHz, 32-bit Cortex™-M3 Core;
- 1 Mbyte Flash memory;
- 128 + 4 Kbytes of SRAM;
- 83 I/O pins;
- SPI, I²C, CAN, USB, Ethernet;
- USART, UART;
- 16-bit and 32-bit Timers, up to 120MHz;
- Internal Oscillator 16MHz, 32kHz, PLL;
- ADC, DAC, etc.

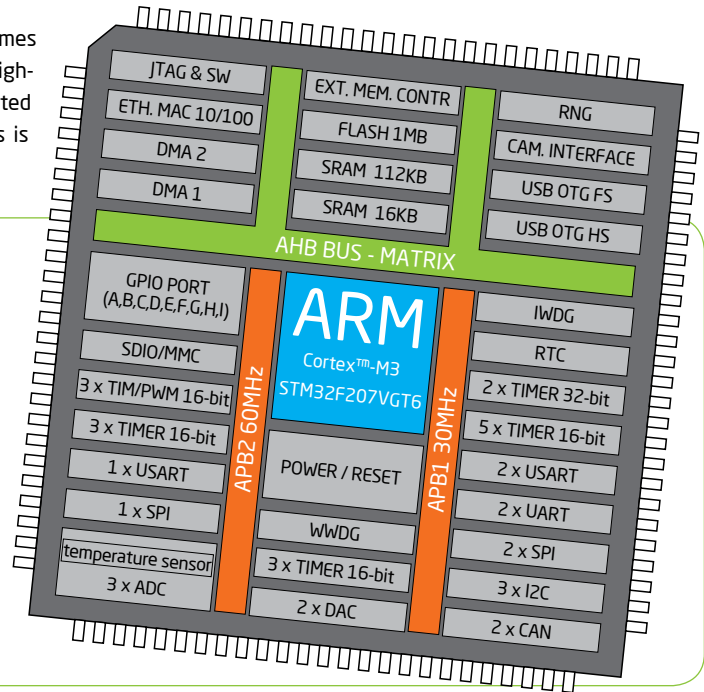

The mikromedia for STM32® M4 development system comes with the **STM32F407VGT6** microcontroller, which can deliver even more processing power. With up to 168MHz operation, this **32-bit** microcontroller with other on-board modules is a perfect choice for performance-demanding applications.

STM32F407VGT6

- 1.25 DMIPS/MHz, 32-bit Cortex™-M4 Core;
- 1 MB flash memory;
- 192 + 4 KB of SRAM;
- 83 I/O pins;
- SPI, I²C, CAN, USB, Ethernet;
- USART, UART;
- 16-bit and 32-bit Timers, up to 168MHz;
- Internal Oscillator 16MHz, 32kHz, PLL;
- ADC, DAC, etc.

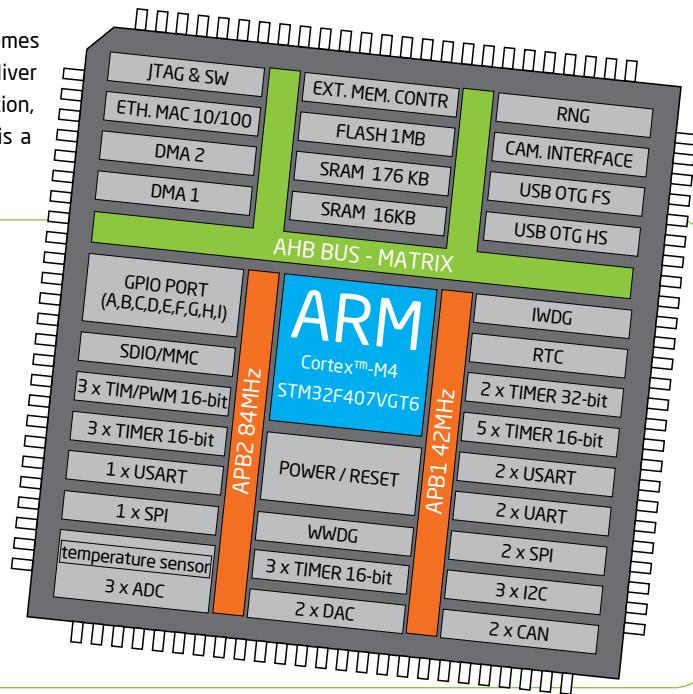

3. Programming the microcontroller

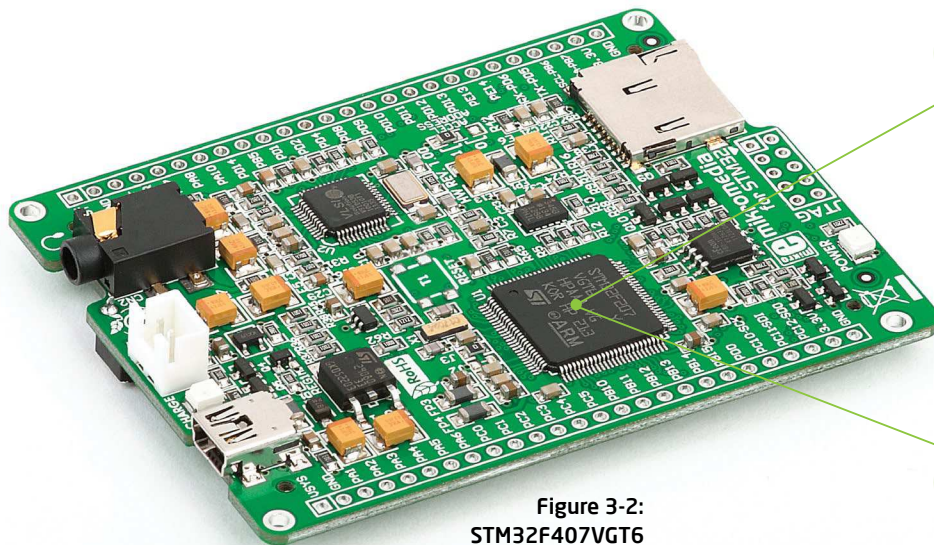

Figure 3-2:
STM32F407VGT6
Microcontroller



Figure 3-1:
STM32F207VGT6
Microcontroller



The microcontroller can be programmed in three ways:



The mikromedia for STM32® development system can be programmed in three different ways. 01 Using the bootloader which is preprogrammed into the device by default or via external programmers (02 mikroProg™ or 03 ST-LINK V2™).

Programming with mikroBootloader

You can program the microcontroller with bootloader which is preprogrammed into the device by default. To transfer .hex file from a PC to MCU you need bootloader software (**mikroBootloader USB HID**) which can be downloaded from:



www.mikroe.com/downloads/get/1849/mikrobootloader_mikromedia_stm32_v210b.zip

Upon download, unzip it to desired location and start the mikroBootloader application:

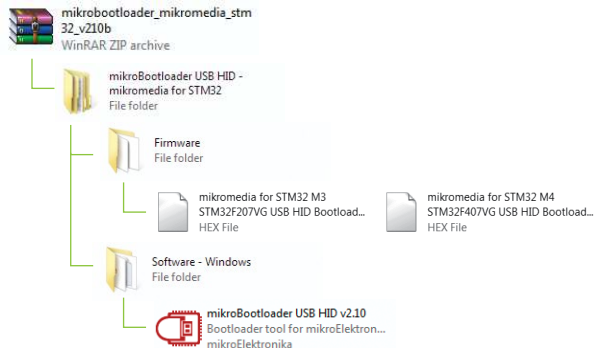

step 1 - Connecting mikromedia



Figure 3-3: USB HID mikroBootloader window

- 01 To start, connect the USB cable, or if already connected press the **Reset** button on your mikromedia board. Click the **Connect** button within 5s to enter the bootloader mode, otherwise existing microcontroller program will execute.

step 2 - Browsing for .HEX file



Figure 3-4: Browse for HEX

- 01 Click the **Browse for HEX** button and from a pop-up window (Figure 3.5) choose the .HEX file which will be uploaded to MCU memory.

step 3 - Selecting .HEX file

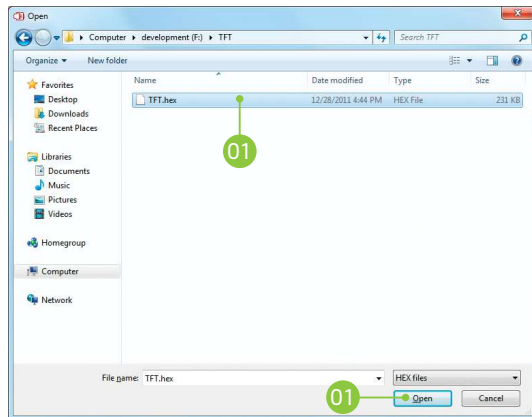

Figure 3-5: Selecting HEX

- 01 Select .HEX file using open dialog window.
- 02 Click **Open**.

step 4 - Uploading .HEX file



Figure 3-6: Begin uploading

- 01** To start .HEX file bootloading click the **Begin uploading** button.



Figure 3-7: Progress bar

- 01** Progress bar enables you to monitor .HEX file uploading.

step 5 - Finish upload



Figure 3-8: Restarting MCU

- 01 Click **OK** after uploading is finished and wait for 5 seconds. Board will automatically reset and your new program will execute.



Figure 3-9: mikroBootloader ready for next job

Programming with mikroProg™ programmer

The microcontroller can be programmed with external **mikroProg™ for STM32® programmer** and **mikroProg Suite™ for ARM®** software. The mikroProg™ programmer is connected to the development system via the CN5 (JTAG) connector. You can choose between two ways to program microcontrollers , **Figure 3-14**:

- 01 Via JTAG interface
- 02 Via Serial wire debug (SWD) interface



Figure 3-10:
Connecting
mikroProg™ to
mikromedia™

mikroProg™ is a fast USB 2.0 programmer with mikroCD™ hardware In-Circuit Debugger. It supports over 180 ARM® Cortex™ M3 and Cortex™ M4 microcontrollers from STM32® family. Outstanding performance, easy operation and elegant design are its key features.

NOTE: Before attaching the programming connector, you have to solder the provided 2x5 male header to the JTAG pads (CN5)

mikroProg Suite™ for ARM® software

On-board mikroProg™ programmer requires special programming software called mikroProg Suite™ for ARM®. This software is used for programming of all supported microcontroller families with ARM® Cortex™-M3 and Cortex™-M4 cores. The software has an intuitive interface and SingleClick™ programming technology. To begin, first locate the installation archive on the link below:



http://www.mikroe.com/downloads/get/1809/mikroprog_suite_for_arm.zip

After downloading, extract the package and double click the executable setup file, to start installation.

Quick guide

- 01 Click the **Detect MCU** button in order to recognize the device ID.
- 02 Click the **Read** button to read the entire microcontroller memory. You can click the **Save** button to save it to the target HEX file.
- 03 If you want to write the HEX file into the microcontroller, first make sure to load the target HEX file using the **Load** button. Then click the **Write** button to begin programming.
- 04 Click the **Erase** button to clear the microcontroller memory.

Figure 3-11:
mikroProg Suite™
for ARM® window



Programming with ST-LINK V2 programmer

The microcontroller can also be programmed with the **ST-LINK V2 programmer** and **mikroProg Suite™ for ARM®** software, **Figure 3-11**. This programmer connects with mikromedia board via **mikroProg to ST-LINK V2 adapter**.

In order to adjust the ST-LINK™ V2 programmer to be connected to the development system, it is necessary to provide the appropriate adapter such as the **mikroProg to ST-LINK V2 adapter**. 2x5 male headers should be first soldered on the CN5 connector pads. Then you should plug the adapter into the ST-LINK V2 programmer (2x10 header), and plug an IDC10 flat cable in headers, **Figure 3-13**

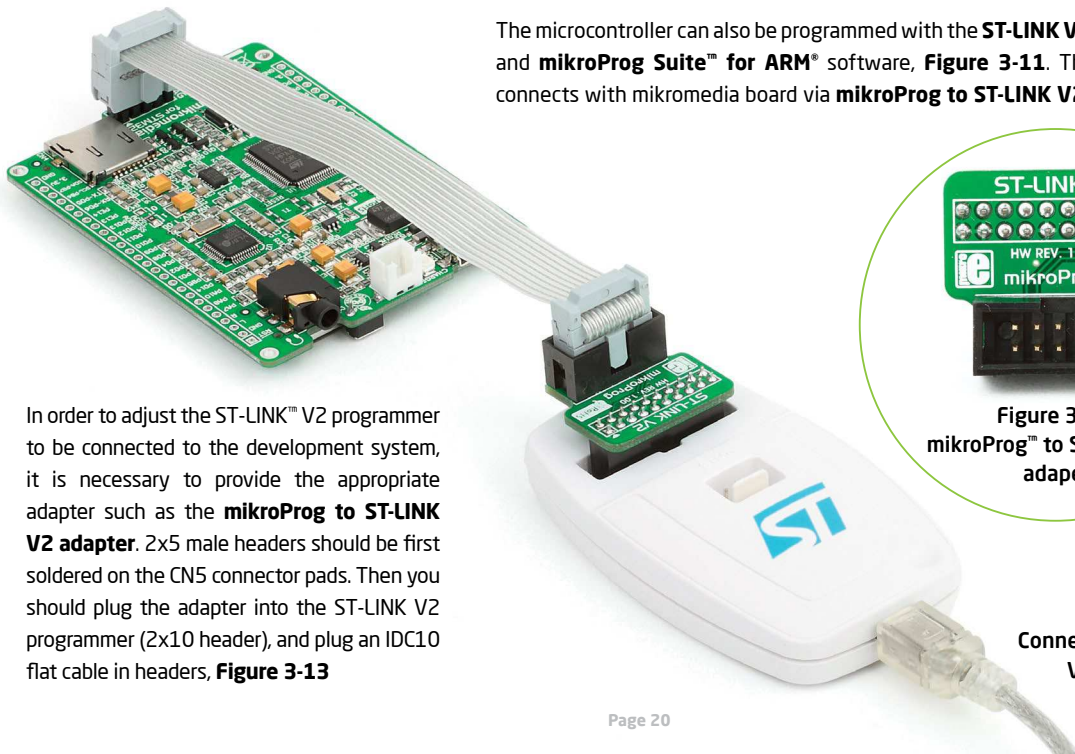

Figure 3-12:
mikroProg™ to ST-LINK™ V2
adaper

Figure 3-13:
Connecting ST-LINK™
V2 programmer

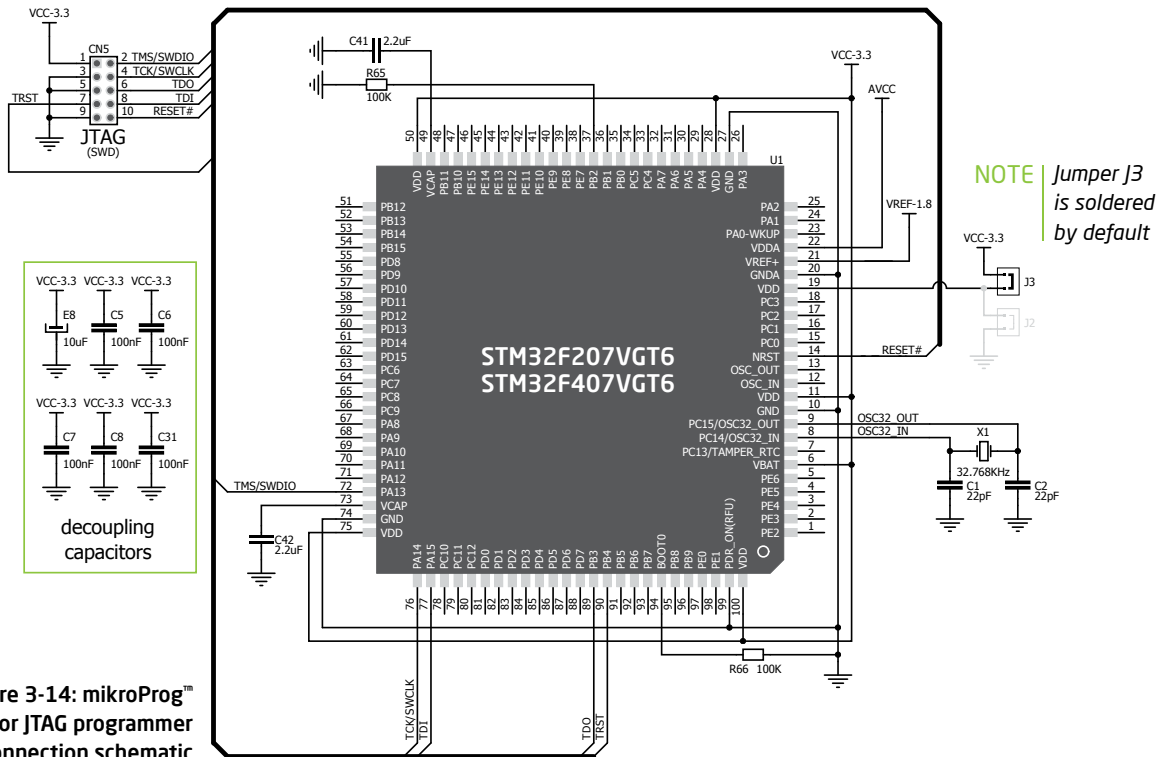
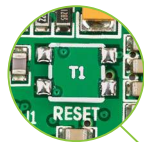

Figure 3-14: mikroProg™ or JTAG programmer connection schematic

4. Reset button

Board is equipped with a reset button, which is located at the top of the front side (**Figure 4-2**). If you want to reset the circuit, press the reset button. It will generate a low voltage level on microcontroller reset pin (input). In addition, a reset can be externally provided through **pin 27** on side headers (**Figure 4-3**).



NOTE You can also solder additional reset button on the appropriate place at the back side of the board, **Figure 4-1**.

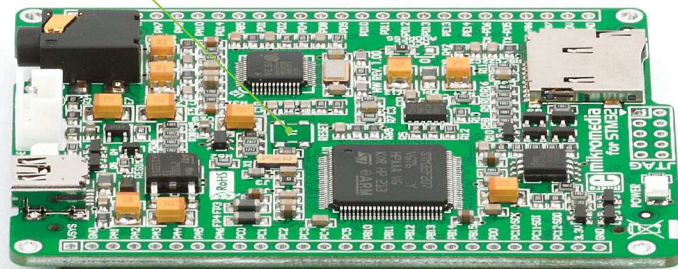

Figure 4-1: Location of additional reset button

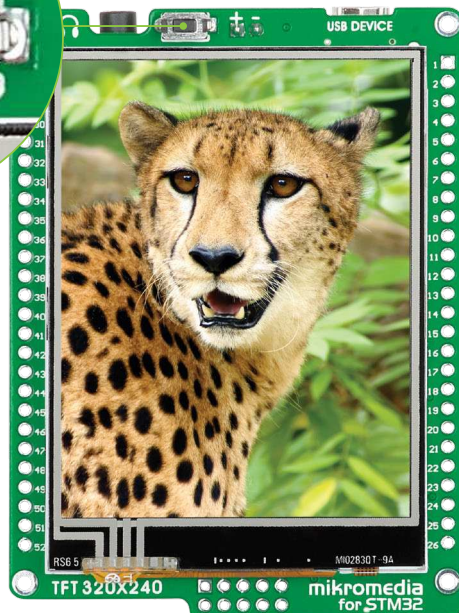
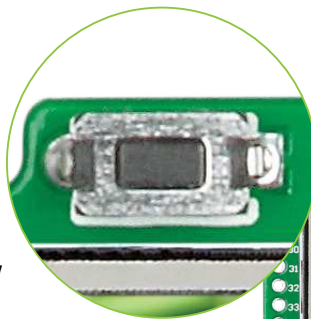

Figure 4-2: Frontal reset button

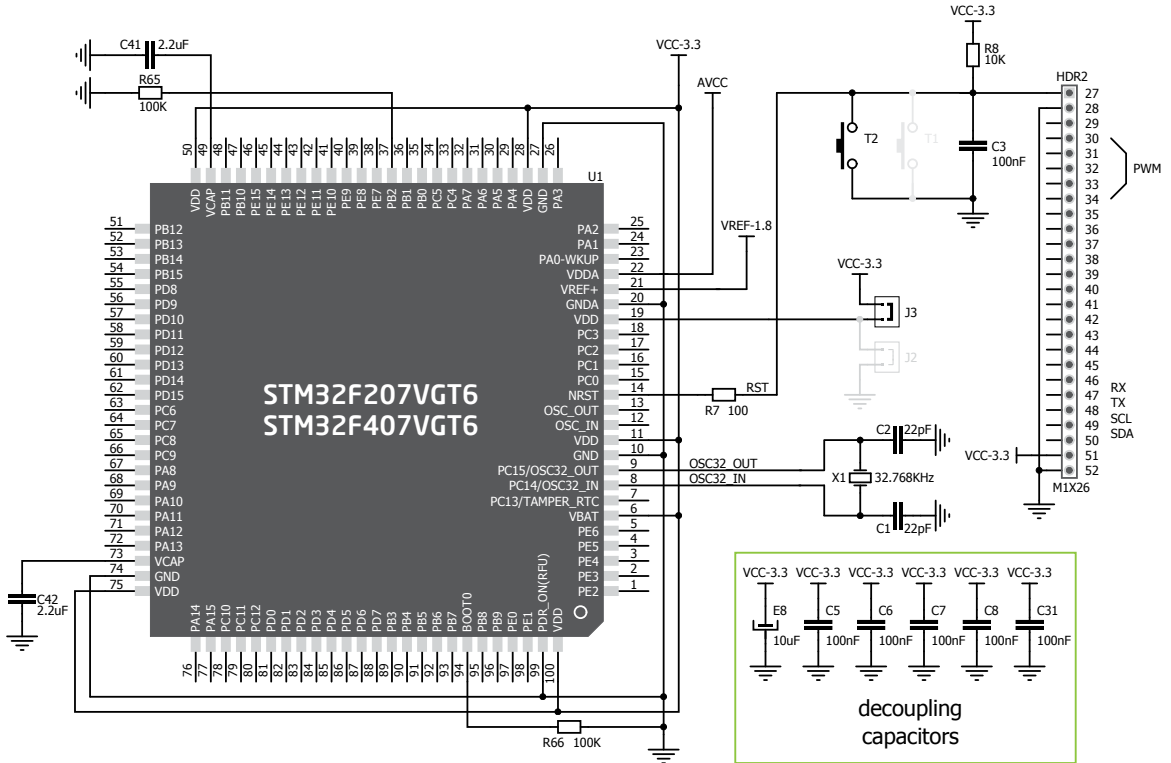

Figure 4-3: Reset circuit schematic

5. Oscillators

STM32F207VGT6 and **STM32F407VGT6** microcontrollers are equipped with an internal **16MHz RC oscillator** that provides a stable clock signal. Since the chips have an integrated PLL, this base frequency is suitable for further clock multiplication. Board also contains a **32.768kHz Crystal oscillator (X1)** which provides an external clock for internal **RTCC** module.

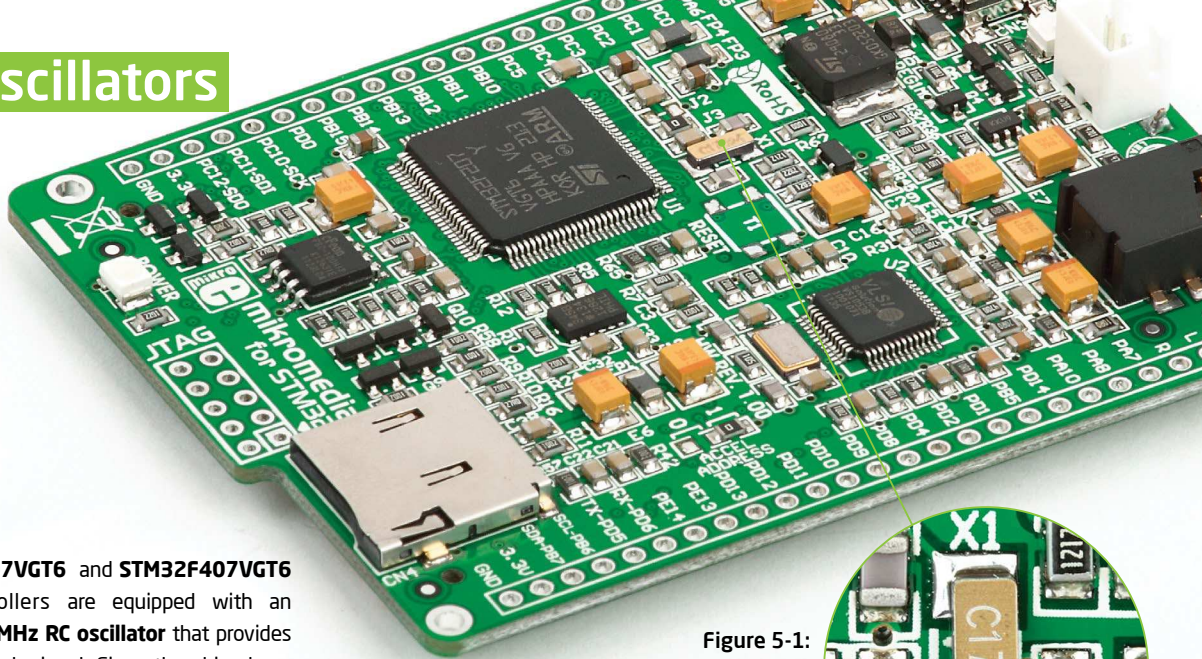
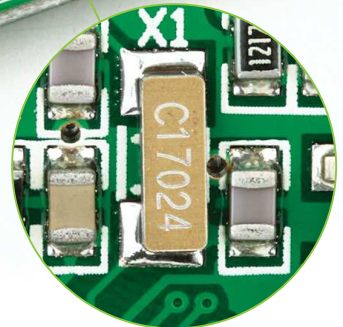

Figure 5-1:
Crystal oscillator
module (X1)



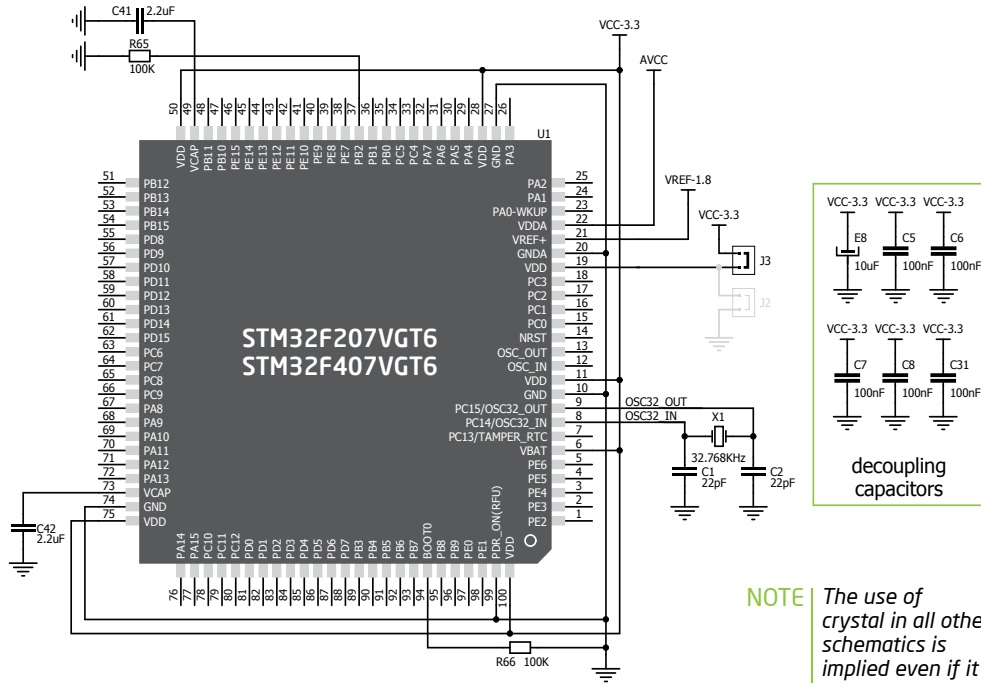

Figure 5-2: Crystal oscillator schematic

NOTE *The use of crystal in all other schematics is implied even if it is purposely left out, because of the schematics clarity.*