



Chipsmall Limited consists of a professional team with an average of over 10 year of expertise in the distribution of electronic components. Based in Hongkong, we have already established firm and mutual-benefit business relationships with customers from,Europe,America and south Asia,supplying obsolete and hard-to-find components to meet their specific needs.

With the principle of "Quality Parts,Customers Priority,Honest Operation,and Considerate Service",our business mainly focus on the distribution of electronic components. Line cards we deal with include Microchip,ALPS,ROHM,Xilinx,Pulse,ON,Everlight and Freescale. Main products comprise IC,Modules,Potentiometer,IC Socket,Relay,Connector.Our parts cover such applications as commercial,industrial, and automotives areas.

We are looking forward to setting up business relationship with you and hope to provide you with the best service and solution. Let us make a better world for our industry!



Contact us

Tel: +86-755-8981 8866 Fax: +86-755-8427 6832

Email & Skype: info@chipsmall.com Web: www.chipsmall.com

Address: A1208, Overseas Decoration Building, #122 Zhenhua RD., Futian, Shenzhen, China



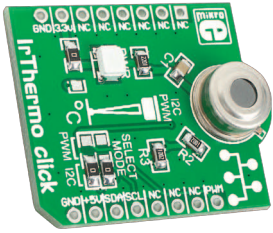

3.3V

IrThermo click™

1. Introduction

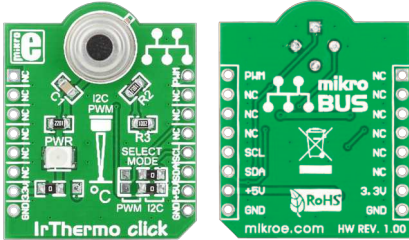

IrThermo Click™ is an accessory board in **mikroBUS™** form factor. It's a compact and easy solution for adding InfraRed (Ir) Thermometer to your design. It features **MLX90614ESF-BAA** single zone Infrared (Ir) thermometer module. IrThermo Click™ communicates with target board microcontroller via **mikroBUS™** I²C lines (SCL, SDA) and PWM line. The board is designed to use 3.3V power supply only. LED diode indicates the presence of power supply.

2. Soldering the headers

Before using your click board™, make sure to solder 1x8 male headers to both left and right side of the board. Two 1x8 male headers are included with the board in the package.



1

2

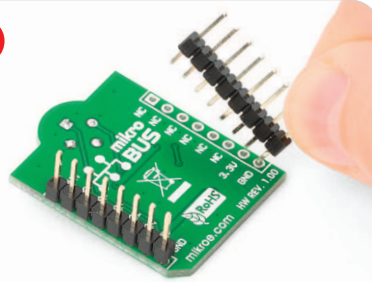

Turn the board upside down so that bottom side is facing you upwards. Place shorter parts of the header pins in both soldering pad locations.

3

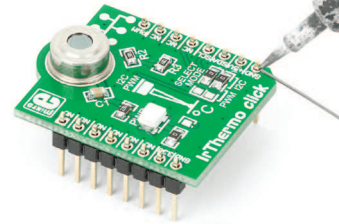

Turn the board upward again. Make sure to align the headers so that they are perpendicular to the board, then solder the pins carefully.

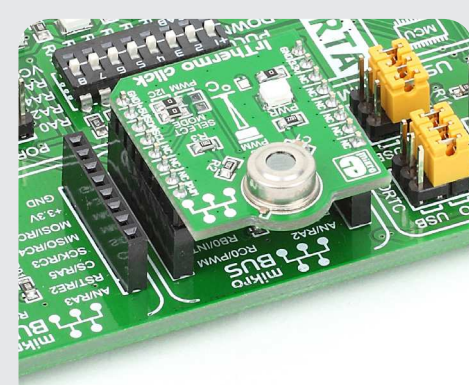

4. Essential features

IrThermo Click™ with its **MLX90614** IC is a compact solution for non contact temperature measurements. The **MLX90614** contains 17-bit ADC , powerful DSP unit and 10-bit PWM. It is calibrated in wide temperature ranges: -40 to 85°C for the ambient temperature and -70 to +380 °C for the object temperature (-20 to 120 °C in PWM mode). These features make this board ideal for automotive, industrial control, body temperature and many more.

3. Plugging the board in

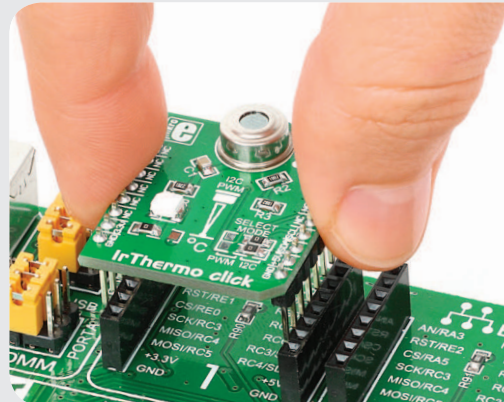

Once you have soldered the headers your board is ready to be placed into desired mikroBUS™ socket. Make sure to align the cut in the lower-right part of the board with the markings on the silkscreen at the mikroBUS™ socket. If all of the pins are aligned correctly, push the board all the way into the socket.

click™
BOARD
www.mikroe.com

IrThermo click - 3.3V
ver. 1.00



5. IrThermo Click™ Board Schematic

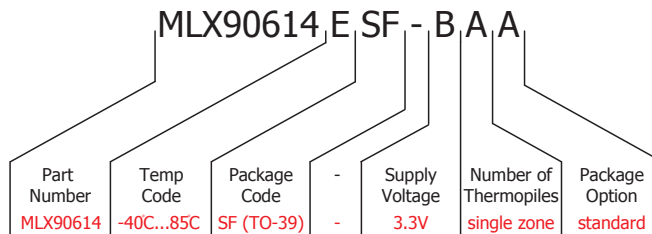
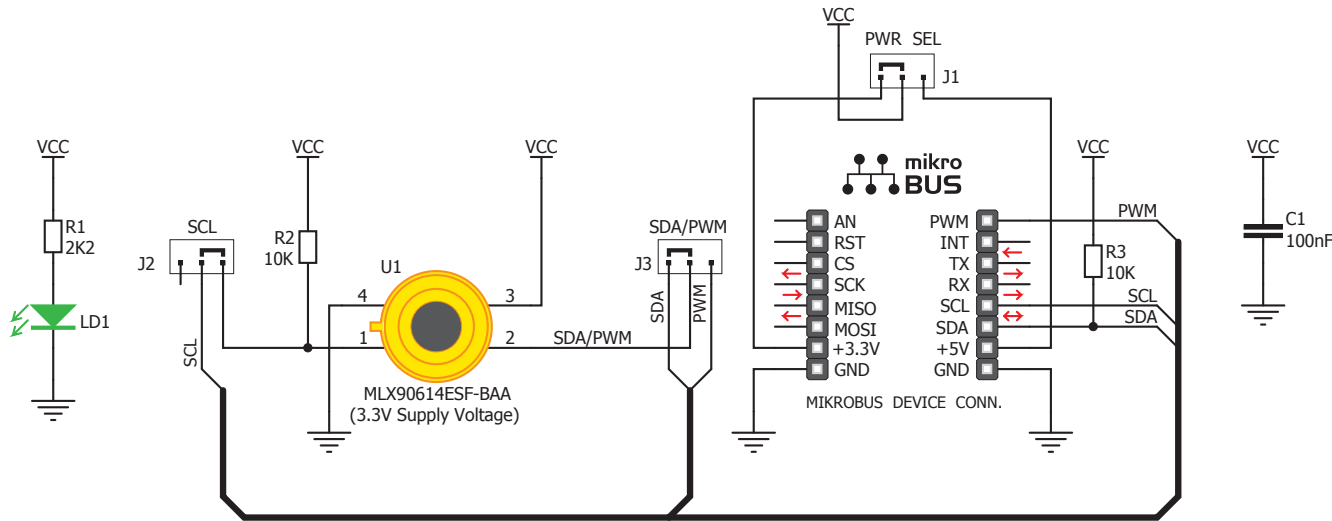

MikroElektronika assumes no responsibility or liability for any errors or inaccuracies that may appear in the present document. Specification and information contained in the present schematic are subject to change at any time without notice. Copyright © 2012 MikroElektronika. All rights reserved.

6. SMD Jumpers

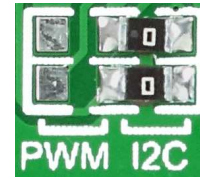

By placing SMD jumpers **J2** and **J3** in appropriate position (I²C or PWM) you will be able to change communication interface between target board micro-controller and **MLX90614** module. Jumpers are soldered in I²C position by default.

7. Code Examples

Once you have done all the necessary preparations, it's time to get your click board up and running. We have provided the examples for mikroC, mikroBasic and mikroPascal compilers on our **Libstock** website. Just download them and you are ready to start.



8. Support

MikroElektronika offers **Free Tech Support** (www.mikroe.com/esupport) until the end of product lifetime, so if something goes wrong, we are ready and willing to help!

