



Chipsmall Limited consists of a professional team with an average of over 10 year of expertise in the distribution of electronic components. Based in Hongkong, we have already established firm and mutual-benefit business relationships with customers from,Europe,America and south Asia,supplying obsolete and hard-to-find components to meet their specific needs.

With the principle of “Quality Parts,Customers Priority,Honest Operation,and Considerate Service”,our business mainly focus on the distribution of electronic components. Line cards we deal with include Microchip,ALPS,ROHM,Xilinx,Pulse,ON,Everlight and Freescale. Main products comprise IC,Modules,Potentiometer,IC Socket,Relay,Connector.Our parts cover such applications as commercial,industrial, and automotives areas.

We are looking forward to setting up business relationship with you and hope to provide you with the best service and solution. Let us make a better world for our industry!



Contact us

Tel: +86-755-8981 8866 Fax: +86-755-8427 6832

Email & Skype: info@chipsmall.com Web: www.chipsmall.com

Address: A1208, Overseas Decoration Building, #122 Zhenhua RD., Futian, Shenzhen, China



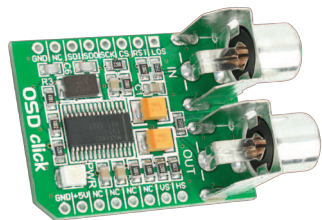

OSD click™

1. Introduction

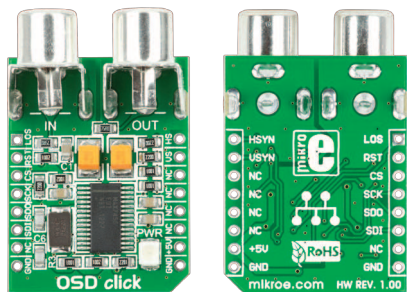

OSD Click™ is an add-on board in **mikroBUS™** form factor. It's a compact and easy solution for adding monochrome on-screen display (OSD) generator to your design. It features **MAX7456** single-channel monochrome OSD module with integrated EEPROM memory as well as two RCA sockets. OSD Click™ communicates with target board microcontroller via **mikroBUS™** SPI (SDI, SDO, SCK, CS#), RST, LOS, HSYNC and VSYNC lines. The board is designed to use 5V power supply only. LED diode (Green) indicates the presence of power supply.

2. Soldering the headers

Before using your click board™, make sure to solder 1x8 male headers to both left and right side of the board. Two 1x8 male headers are included with the board in the package.



1

2

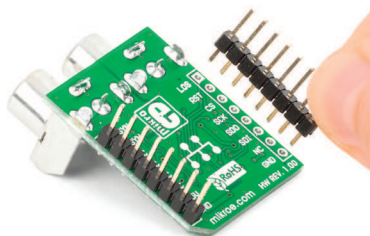

Turn the board upside down so that bottom side is facing you upwards. Place shorter parts of the header pins in both soldering pad locations.

3

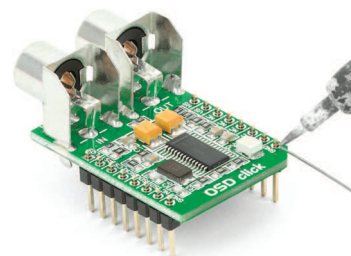

Turn the board upward again. Make sure to align the headers so that they are perpendicular to the board, then solder the pins carefully.

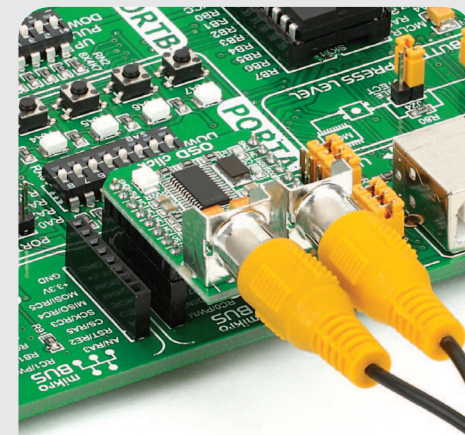

4. Essential features

OSD Click™ with its **MAX7456** IC easily displays information such as custom graphics, time and date using 256 user-programmable characters or pictographs. It is NTSC and PAL compatible and displays up to 16 rows x 30 characters. **MAX7456** has internal sync generator. All these features make this board ideal for security switching systems and cameras, industrial applications, consumer electronics and many more.

3. Plugging the board in

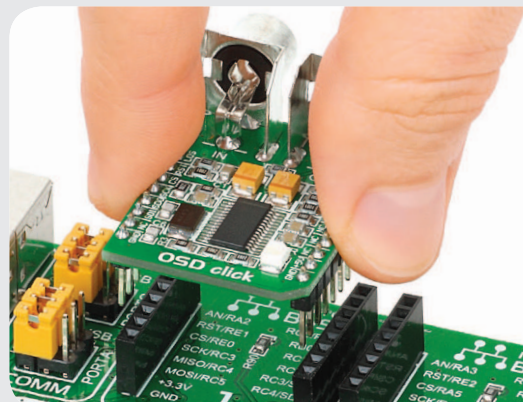

Once you have soldered the headers your board is ready to be placed into desired mikroBUS™ socket. Make sure to align the cut in the lower-right part of the board with the markings on the silkscreen at the mikroBUS™ socket. If all of the pins are aligned correctly, push the board all the way into the socket.

click™
BOARD
www.mikroe.com



OSD click Manual
ver. 1.00



5. OSD Click™ Board Schematic

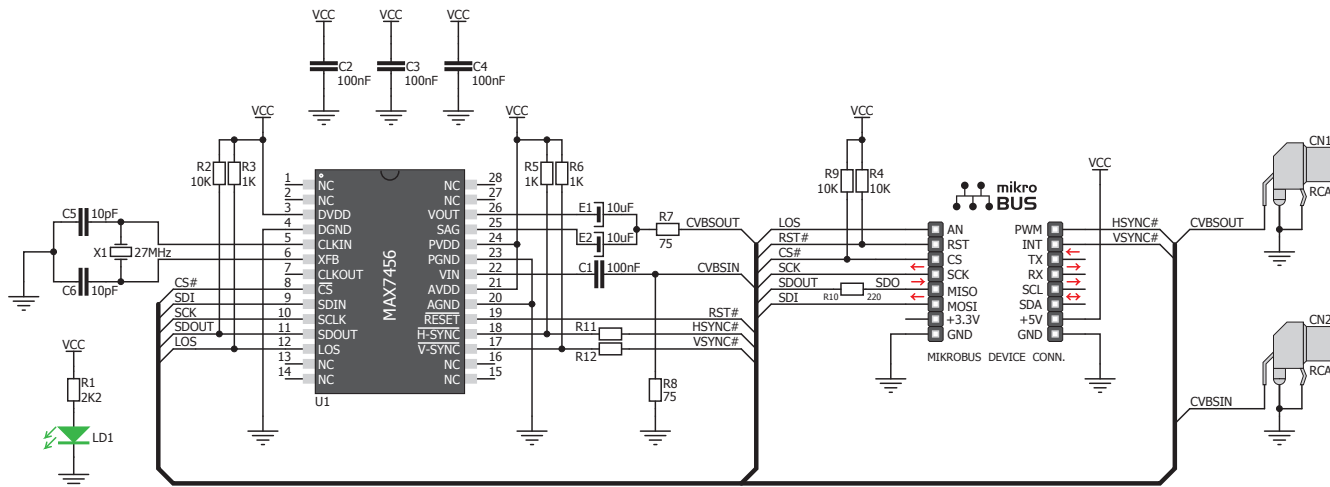

6. Composite video sockets

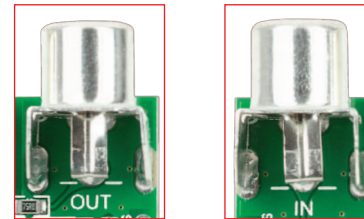

There are two RCA sockets:

CN1 - composite video OUT.

CN2 - PAL or NTSC composite video IN.

7. Code Examples

Once you have done all the necessary preparations, it's time to get your click board up and running. We have provided the examples for mikroC, mikroBasic and mikroPascal compilers on our **Libstock** website. Just download them and you are ready to start.



8. Support

MikroElektronika offers **Free Tech Support** (www.mikroe.com/esupport) until the end of product lifetime, so if something goes wrong, we are ready and willing to help!