



Chipsmall Limited consists of a professional team with an average of over 10 year of expertise in the distribution of electronic components. Based in Hongkong, we have already established firm and mutual-benefit business relationships with customers from,Europe,America and south Asia,supplying obsolete and hard-to-find components to meet their specific needs.

With the principle of “Quality Parts,Customers Priority,Honest Operation,and Considerate Service”,our business mainly focus on the distribution of electronic components. Line cards we deal with include Microchip,ALPS,ROHM,Xilinx,Pulse,ON,Everlight and Freescale. Main products comprise IC,Modules,Potentiometer,IC Socket,Relay,Connector.Our parts cover such applications as commercial,industrial, and automotives areas.

We are looking forward to setting up business relationship with you and hope to provide you with the best service and solution. Let us make a better world for our industry!



## Contact us

Tel: +86-755-8981 8866 Fax: +86-755-8427 6832

Email & Skype: info@chipsmall.com Web: www.chipsmall.com

Address: A1208, Overseas Decoration Building, #122 Zhenhua RD., Futian, Shenzhen, China



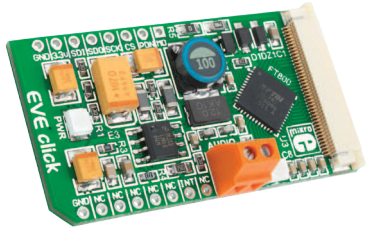

EVE click™

## 1. Introduction

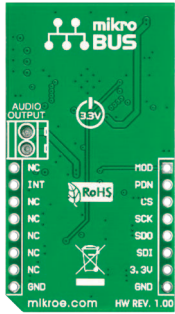
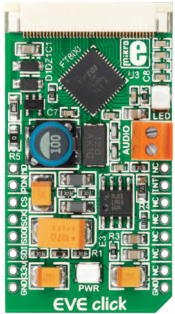

EVE Click™ is an accessory board in **mikroBUS™** form factor. It's a compact and easy solution for adding graphics controller to your design. It features **FT800Q** graphics controller, flat cable connector, **LM4864** audio amplifier, LED diode as well as screw terminals. EVE Click™ communicates with the target board microcontroller via **mikroBUS™** SPI (MISO, MOSI, SCK, CS), INT, RST and AN lines. The board is designed to use 3.3V power supply only. LED diode (GREEN) indicates the presence of power supply.

## 2. Soldering the headers

Before using your click board™, make sure to solder 1x8 male headers to both left and right side of the board. Two 1x8 male headers are included with the board in the package.



2

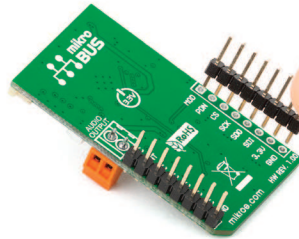

Turn the board upside down so that bottom side is facing you upwards. Place shorter parts of the header pins in both soldering pad locations.

3

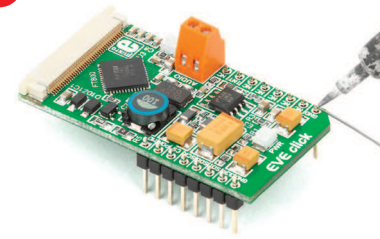

Turn the board upward again. Make sure to align the headers so that they are perpendicular to the board, then solder the pins carefully.

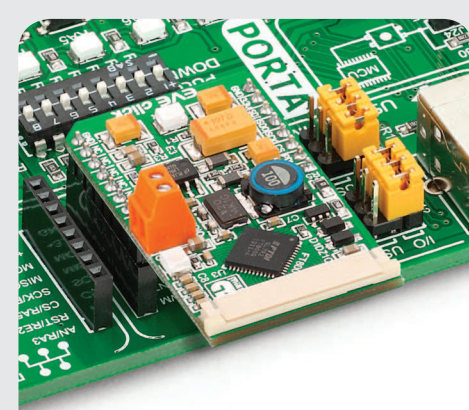

## 4. Essential features

EVE Click™ with its **FT800Q** IC is embedded video engine controller that combines display, audio and touch-screen features. It has SPI interface to main board microcontroller (up to 30 MHz), video RGB parallel output interface, mono audio channel output with PWM (via screw terminals), sound synthesizer, PWM backlight dimming control, 4-wires touch-screen with touch force sensing, several power modes and many more.

## 3. Plugging the board in

Once you have soldered the headers your board is ready to be placed into desired mikroBUS™ socket. Make sure to align the cut in the lower-right part of the board with the markings on the silkscreen at the mikroBUS™ socket. If all of the pins are aligned correctly, push the board all the way into the socket.

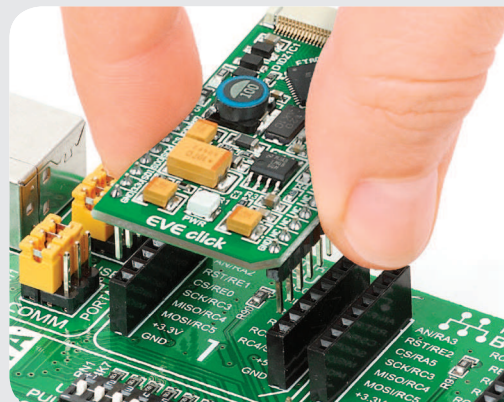

click™  
BOARD  
[www.mikroe.com](http://www.mikroe.com)



EVE click Manual  
ver. 1.00



## 5. EVE Click™ Board Schematic

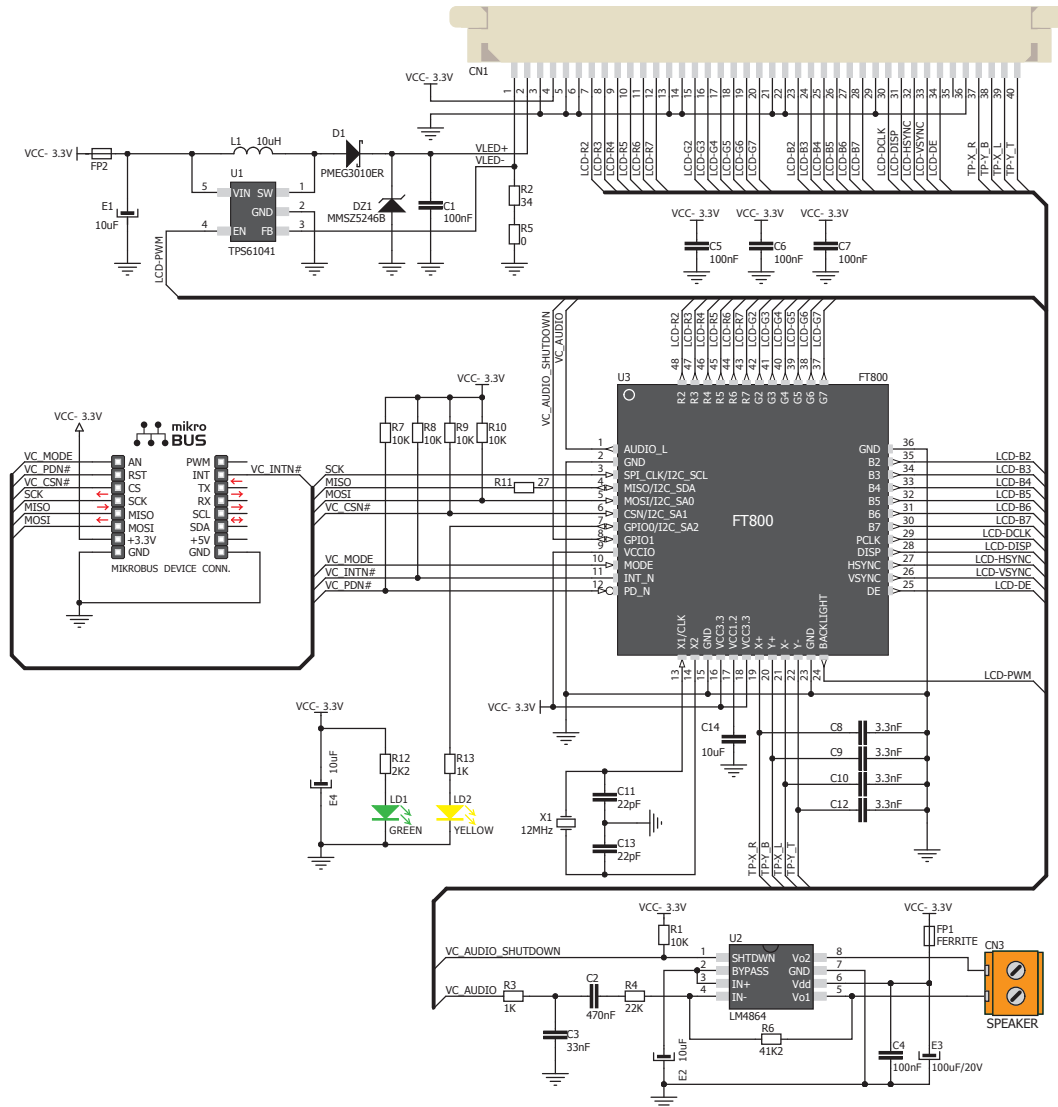

## 6. Flat cable connector

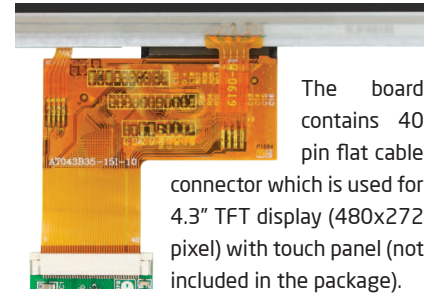

The board contains 40 pin flat cable

connector which is used for 4.3" TFT display (480x272 pixel) with touch panel (not included in the package).

## 7. Code Examples

Once you have done all the necessary preparations, it's time to get your click board up and running. We have provided the examples for mikroC, mikroBasic and mikroPascal compilers on our **Libstock** website. Just download them and you are ready to start.



## 8. Support

MikroElektronika offers **Free Tech Support** ([www.mikroe.com/esupport](http://www.mikroe.com/esupport)) until the end of product lifetime, so if something goes wrong, we are ready and willing to help!