



Chipsmall Limited consists of a professional team with an average of over 10 year of expertise in the distribution of electronic components. Based in Hongkong, we have already established firm and mutual-benefit business relationships with customers from,Europe,America and south Asia,supplying obsolete and hard-to-find components to meet their specific needs.

With the principle of "Quality Parts,Customers Priority,Honest Operation,and Considerate Service",our business mainly focus on the distribution of electronic components. Line cards we deal with include Microchip,ALPS,ROHM,Xilinx,Pulse,ON,Everlight and Freescale. Main products comprise IC,Modules,Potentiometer,IC Socket,Relay,Connector.Our parts cover such applications as commercial,industrial, and automotives areas.

We are looking forward to setting up business relationship with you and hope to provide you with the best service and solution. Let us make a better world for our industry!



## Contact us

Tel: +86-755-8981 8866 Fax: +86-755-8427 6832

Email & Skype: info@chipsmall.com Web: www.chipsmall.com

Address: A1208, Overseas Decoration Building, #122 Zhenhua RD., Futian, Shenzhen, China





## nRF S click™

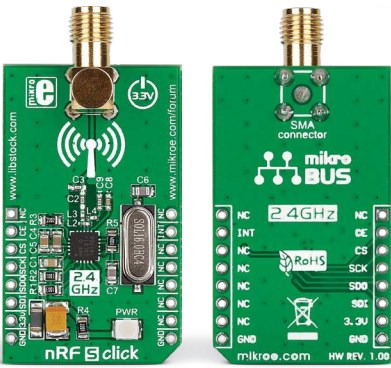

### 1. Introduction

nRF S click™ is a compact and easy solution for adding a 2.4 GHz transceiver to your design. It features **nRF24L01P** 2.4 GHz transceiver module with an embedded baseband protocol engine as well as an SMA antenna connector (antenna sold separately). nRF S click™ communicates with the target board microcontroller via **mikroBUS™** SPI (SDI, SDO, SCK, CS#), CE and INT lines. The board is designed to use 3.3V power supply only.

### 2. Soldering the headers

Before using your click™ board, make sure to solder 1x8 male headers to both left and right side of the board. Two 1x8 male headers are included with the board in the package.

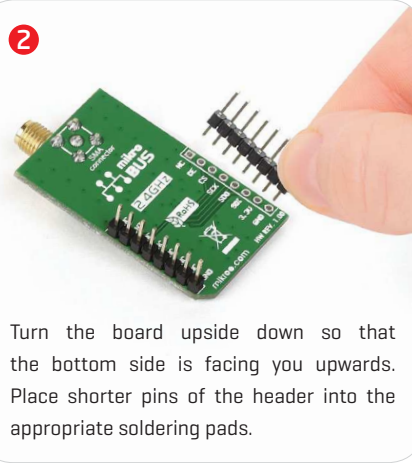

Turn the board upside down so that the bottom side is facing you upwards. Place shorter pins of the header into the appropriate soldering pads.

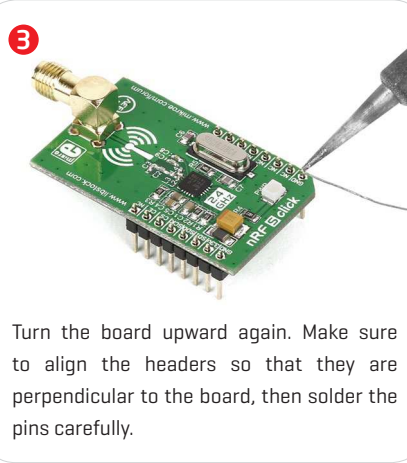
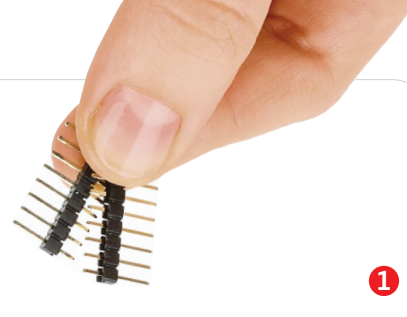

Turn the board upward again. Make sure to align the headers so that they are perpendicular to the board, then solder the pins carefully.

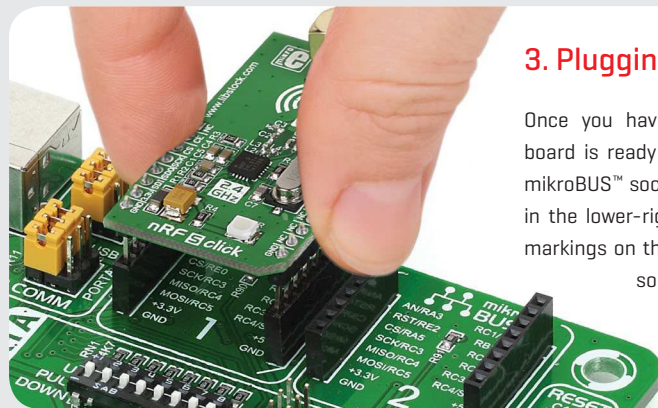

### 3. Plugging the board in

Once you have soldered the headers your board is ready to be placed into the desired mikroBUS™ socket. Make sure to align the cut in the lower-right part of the board with the markings on the silkscreen at the mikroBUS™ socket. If all the pins are aligned correctly, push the board all the way into the socket.

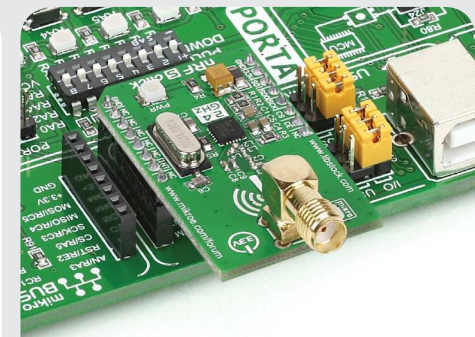

### 4. Essential features

nRF S click™ with its nRF24L01P IC is designed for operation in the world wide ISM frequency band at **2.400 - 2.4835 GHz**. The board supports an air data rate of 250 Kbps, 1 Mbps and 2 Mbps and it is suitable for ultra low power designs. All these features make this board ideal for wireless PC peripherals, remotes, VoIP headsets, game controllers, sensors, home and commercial automation, active RFID, toys and many more.



## 5. Schematic

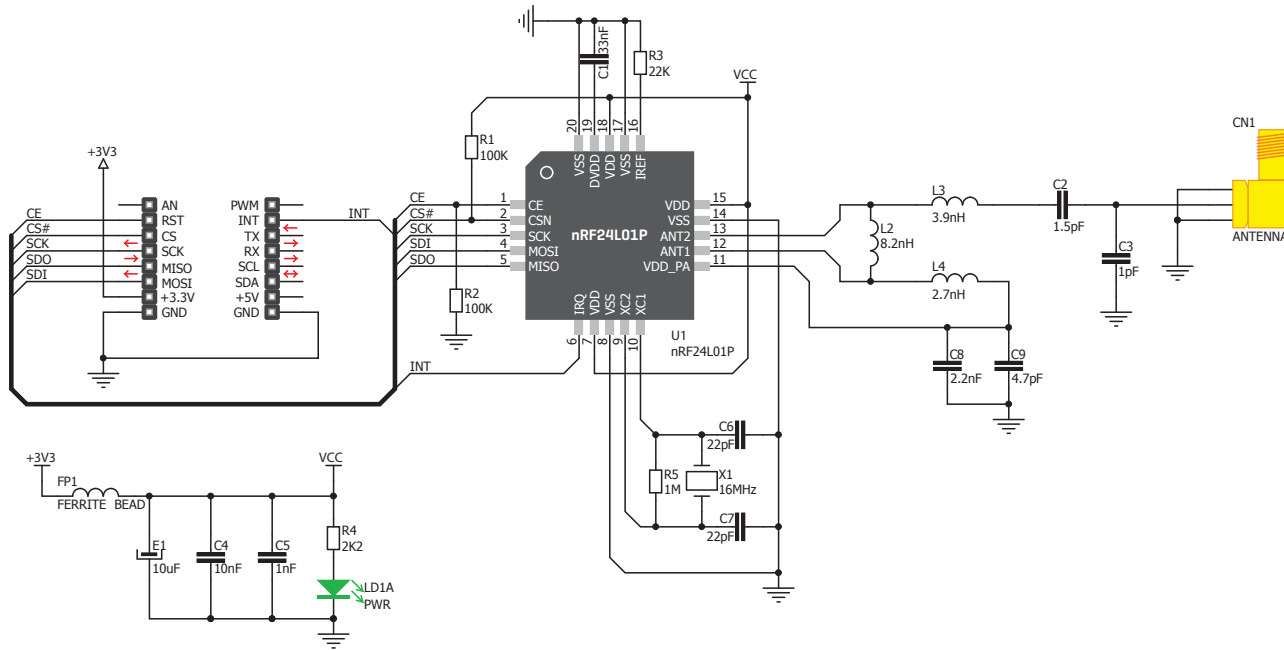

## 6. Dimensions

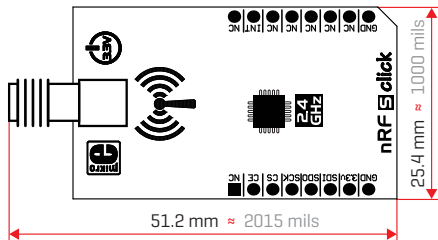

	mm	mils
LENGTH	51.2	2015
WIDTH	25.4	1000
HEIGHT	8.2	323

## 7. Alternative antennas options

Two other click™ boards with the nRF24L01P chip, but with different antennas are available. NRF T click™ with a PCB trace antenna, and nRF C click™ with an SMD chip antenna.

See them at:

[www.mikroe.com/click/nrf-t](http://www.mikroe.com/click/nrf-t)

[www.mikroe.com/cick/nrf-c](http://www.mikroe.com/cick/nrf-c)

## 8. Code examples

Once you have done all the necessary preparations, it's time to get your click™ board up and running. We have provided examples for mikroC™, mikroBasic™ and mikroPascal™ compilers on our **Libstock** website. Just download them and you are ready to start.



## 9. Support

MikroElektronika offers **free tech support** [[www.mikroe.com/support](http://www.mikroe.com/support)] until the end of the product's lifetime, so if something goes wrong, we're ready and willing to help!

MikroElektronika assumes no responsibility or liability for any errors or inaccuracies that may appear in the present document. Specification and information contained in the present schematic are subject to change at any time without notice.

Copyright © 2015 MikroElektronika.

All rights reserved.