



Chipsmall Limited consists of a professional team with an average of over 10 year of expertise in the distribution of electronic components. Based in Hongkong, we have already established firm and mutual-benefit business relationships with customers from,Europe,America and south Asia,supplying obsolete and hard-to-find components to meet their specific needs.

With the principle of "Quality Parts,Customers Priority,Honest Operation,and Considerate Service",our business mainly focus on the distribution of electronic components. Line cards we deal with include Microchip,ALPS,ROHM,Xilinx,Pulse,ON,Everlight and Freescale. Main products comprise IC,Modules,Potentiometer,IC Socket,Relay,Connector.Our parts cover such applications as commercial,industrial, and automotives areas.

We are looking forward to setting up business relationship with you and hope to provide you with the best service and solution. Let us make a better world for our industry!



Contact us

Tel: +86-755-8981 8866 Fax: +86-755-8427 6832

Email & Skype: info@chipsmall.com Web: www.chipsmall.com

Address: A1208, Overseas Decoration Building, #122 Zhenhua RD., Futian, Shenzhen, China



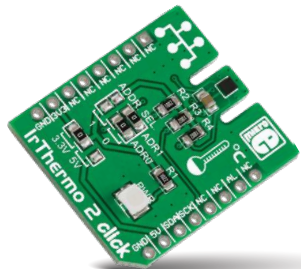

IrThermo 2 click

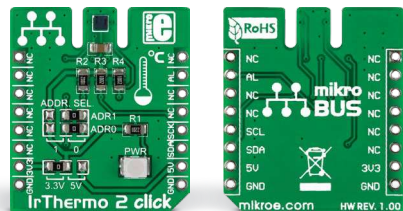

1. Introduction

IrThermo 2 click carries the **TMP007** infrared thermopile sensor with an integrated math engine. The measurement range of the sensor is between -40°C to 125°C [with a 14-bit resolution]. *IrThermo 2 click* communicates with the target board MCU through mikroBUS™ I²C pins (SCL, SDA); there's also an Alert pin in place of the default mikroBUS™ INT. The board is designed to use either a 3.3V or a 5V power supply.

2. Soldering the headers

Before using your click board™, make sure to solder 1x8 male headers to both left and right side of the board. Two 1x8 male headers are included with the board in the package.

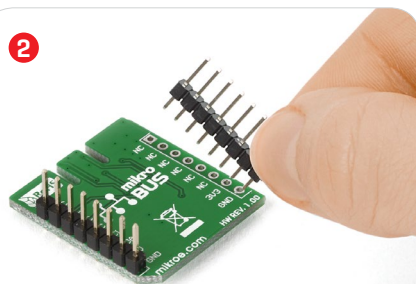
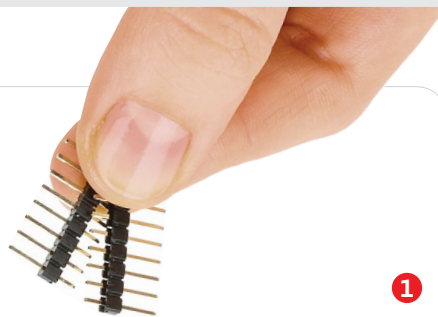

Turn the board upside down so that the bottom side is facing you upwards. Place shorter pins of the header into the appropriate soldering pads.

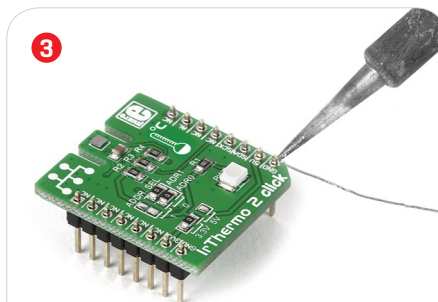

Turn the board upward again. Make sure to align the headers so that they are perpendicular to the board, then solder the pins carefully.

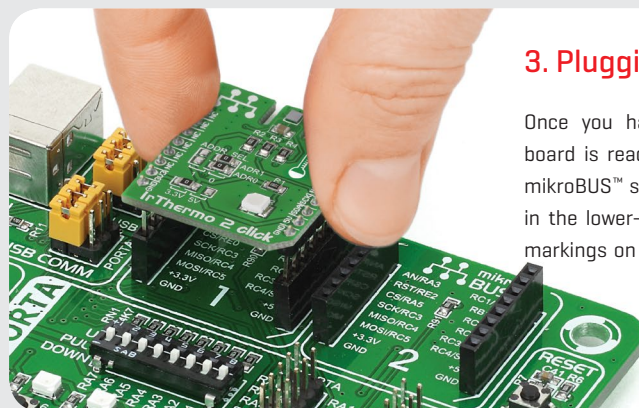

3. Plugging the board in

Once you have soldered the headers your board is ready to be placed into the desired mikroBUS™ socket. Make sure to align the cut in the lower-right part of the board with the markings on the silkscreen at the mikroBUS™ socket. If all the pins are aligned correctly, push the board all the way into the socket.

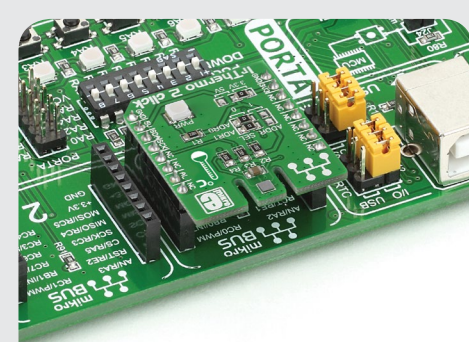

4. Essential features

IrThermo 2 click is a non-contact temperature measurement solution, ideal for monitoring hard to reach objects (too far, inconveniently placed, hazardous, fluid etc.). The sensor absorbs the infrared radiation emitted by the target object [within the sensor's field of view] and the integrated math engine calculates its temperature by comparing it with the temperature of the silicon die. The sensor is factory calibrated, but the user can adjust the calibration coefficients for specific applications [to correct for range, field of view, object shape and environmental factors].

click
BOARD™
www.mikroe.com



IrThermo 2 click manual
ver 1.00



010000079140

5. Schematic

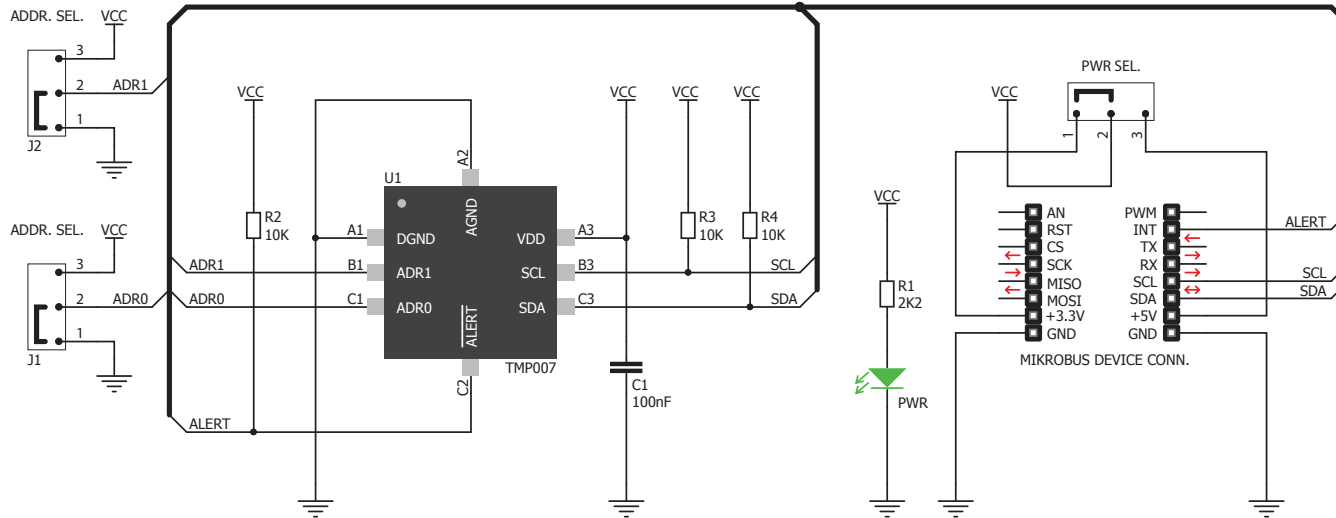

6. Dimensions

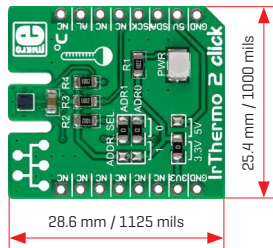

	mm	mils
LENGTH	28.6	1125
WIDTH	25.4	1000
HEIGHT*	3.6	142

* without headers

7. SMD jumpers

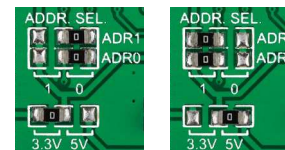

IrThermo 2 click has two sets of jumpers. ADDR. SEL. for specifying the I²C address, and a jumper for switching between 3.3V and 5V power supplies.

8. Code examples

Once you have done all the necessary preparations, it's time to get your click board™ up and running. We have provided examples for mikroC™, mikroBasic™ and mikroPascal™ compilers on our **Libstock** website. Just download them and you are ready to start.



9. Support

MikroElektronika offers **free tech support** [www.mikroe.com/support] until the end of the product's lifetime, so if something goes wrong, we're ready and willing to help!



10. Disclaimer

MikroElektronika assumes no responsibility or liability for any errors or inaccuracies that may appear in the present document. Specification and information contained in the present schematic are subject to change at any time without notice.

Copyright © 2015 MikroElektronika.
All rights reserved.