



Chipsmall Limited consists of a professional team with an average of over 10 year of expertise in the distribution of electronic components. Based in Hongkong, we have already established firm and mutual-benefit business relationships with customers from,Europe,America and south Asia,supplying obsolete and hard-to-find components to meet their specific needs.

With the principle of “Quality Parts,Customers Priority,Honest Operation,and Considerate Service”,our business mainly focus on the distribution of electronic components. Line cards we deal with include Microchip,ALPS,ROHM,Xilinx,Pulse,ON,Everlight and Freescale. Main products comprise IC,Modules,Potentiometer,IC Socket,Relay,Connector.Our parts cover such applications as commercial,industrial, and automotives areas.

We are looking forward to setting up business relationship with you and hope to provide you with the best service and solution. Let us make a better world for our industry!



Contact us

Tel: +86-755-8981 8866 Fax: +86-755-8427 6832

Email & Skype: info@chipsmall.com Web: www.chipsmall.com

Address: A1208, Overseas Decoration Building, #122 Zhenhua RD., Futian, Shenzhen, China





GNSS 3 click

2. Soldering the headers

Before using your click board™, make sure to solder 1x8 male headers to both left and right side of the board. Two 1x8 male headers are included with the board in the package.

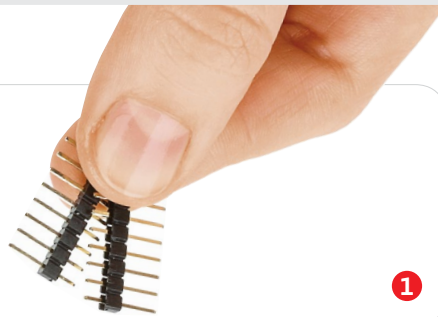

2

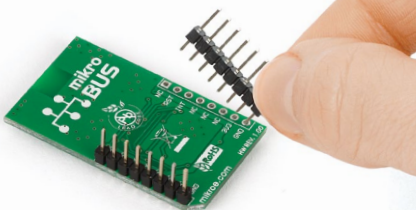

Turn the board upside down so that the bottom side is facing you upwards. Place shorter pins of the header into the appropriate soldering pads.

3

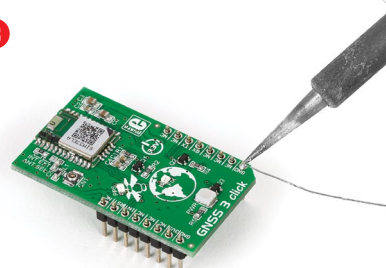

Turn the board upward again. Make sure to align the headers so that they are perpendicular to the board, then solder the pins carefully.

1. Introduction

GNSS3 click carries SIMCom's **SIM33ELA** standalone GNSS module with an integrated antenna [as well as a connector for an external one] GNSS stands for Global Navigation Satellite System, an umbrella term that describes both the United States GPS and the Russian GLONASS global positioning systems. The SIM33ELA module has MTK's high sensitivity navigation engine. The click communicates with the target MCU through mikroBUS™ UART pins [RX, TX], with additional functionality provided through RST and INT pins. 3.3V power supply only.

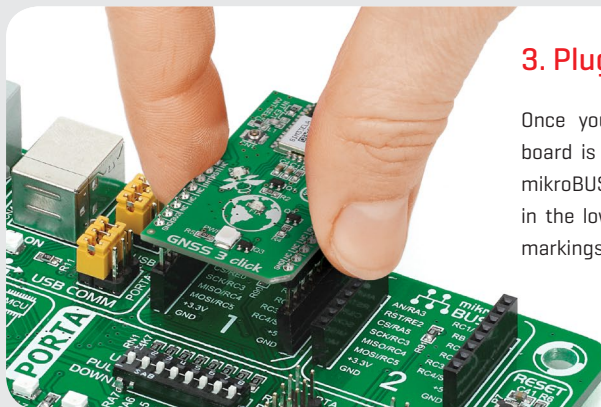

3. Plugging the board in

Once you have soldered the headers your board is ready to be placed into the desired mikroBUS™ socket. Make sure to align the cut in the lower-right part of the board with the markings on the silkscreen at the mikroBUS™ socket. If all the pins are aligned correctly, push the board all the way into the socket.

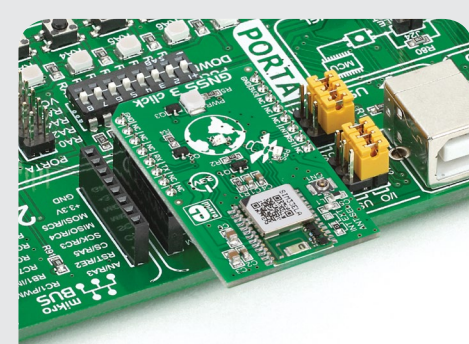

4. Essential features

The SIM33ELA module on GNSS3 click features both **EPO™** orbit prediction and **Easy™** self-generated orbit prediction. It also supports AGPS and SBAS ranging [WAAS, EGNOS, GAGAN, MSAS]. For cold starts, the SIM33ELA module has TTFF [Time To First Fix] of 28 seconds, 13 if EPO assist is used. TTFF is 26 seconds for warm starts, and less than a second for hot starts. The device has tracking sensitivity of -165 dBm, reacquisition sensitivity of -160 dBm, and cold start sensitivity of -147 dBm.

click
BOARD™

www.mikroe.com



GNSS3 click manual v100



0100000080740

5. Schematic

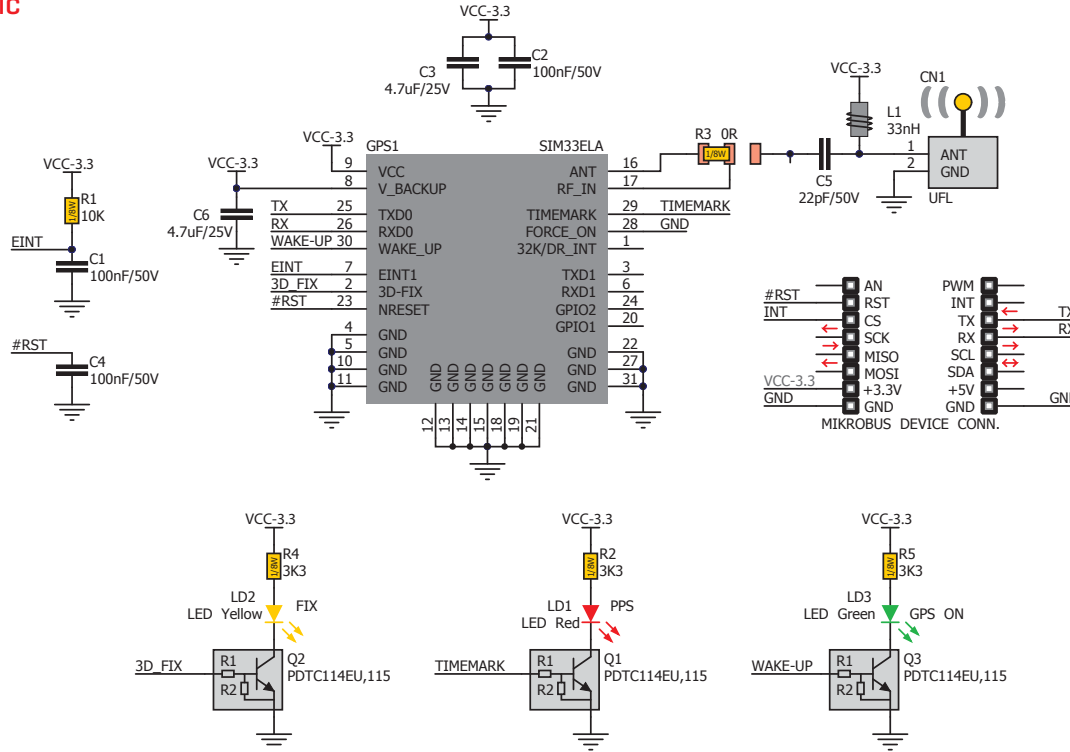

6. Dimensions

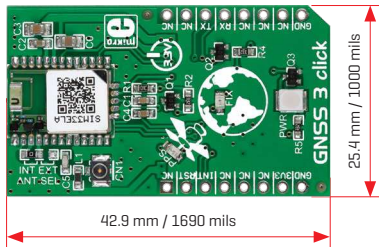

	mm	mils
LENGTH	42.9	1690
WIDTH	25.4	1000
HEIGHT*	3.9	154

* without headers

7. ANT SEL

GNSS3 click has both an internal antenna as well as a connector for an external patch antenna. To use an external antenna (which is sold separately), solder the ANT SEL SMD jumper (zero ohm resistor) to EXT position.



8. Code examples

Once you have done all the necessary preparations, it's time to get your click board™ up and running. We have provided examples for mikroC™, mikroBasic™ and mikroPascal™ compilers on our **Libstock** website. Just download them and you are ready to start.



9. Support

MikroElektronika offers **free tech support** [www.mikroe.com/support] until the end of the product's lifetime, so if something goes wrong, we're ready and willing to help!



10. Disclaimer

MikroElektronika assumes no responsibility or liability for any errors or inaccuracies that may appear in the present document. Specification and information contained in the present schematic are subject to change at any time without notice.

Copyright © 2015 MikroElektronika.
All rights reserved.