



Chipsmall Limited consists of a professional team with an average of over 10 year of expertise in the distribution of electronic components. Based in Hongkong, we have already established firm and mutual-benefit business relationships with customers from,Europe,America and south Asia,supplying obsolete and hard-to-find components to meet their specific needs.

With the principle of “Quality Parts,Customers Priority,Honest Operation,and Considerate Service”,our business mainly focus on the distribution of electronic components. Line cards we deal with include Microchip,ALPS,ROHM,Xilinx,Pulse,ON,Everlight and Freescale. Main products comprise IC,Modules,Potentiometer,IC Socket,Relay,Connector.Our parts cover such applications as commercial,industrial, and automotives areas.

We are looking forward to setting up business relationship with you and hope to provide you with the best service and solution. Let us make a better world for our industry!



Contact us

Tel: +86-755-8981 8866 Fax: +86-755-8427 6832

Email & Skype: info@chipsmall.com Web: www.chipsmall.com

Address: A1208, Overseas Decoration Building, #122 Zhenhua RD., Futian, Shenzhen, China





CLICKER² CECL302

All the inventions waiting to happen...

clicker 2 is a battery-powered click™ board two-seater. Inventing and putting together fully-functional standalone gadgets is now just 1% perspiration, and 99% inspiration!

Thousands of possibilities



With two mikroBUS™ sockets on clicker 2, you can take advantage of the huge potential of click™ boards, the constantly expanding range of over 196 add-on boards. Blend different functionalities together and come up with new and original inventions. That's just two clicks and your project is half-way done. Go ahead and play with a few ideas right away:

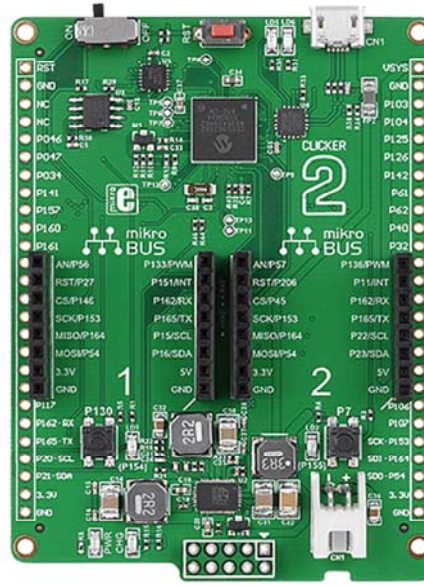

Security ensured

This clicker 2 is powered by CEC1302, a 32-bit ARM®-Cortex® MCU from Microchip that integrates a cryptographic engine that provides high level security features.

- Authentication with public key algorithms (RSA-2048)
- Integrity with Secure Hash Algorithms (SHA-1, SHA-256)
- Privacy with symmetric encryption (AES)
- Entropy with true Random Number Generator

CEC1302 has 128 KB SRAM, 32 KB boot ROM, and runs at 48MHz.



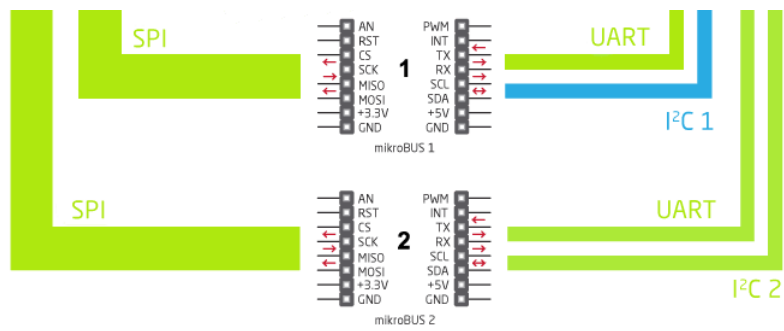

Powering Your Inventions

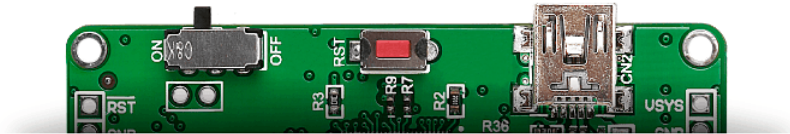

Focus on your main idea because clicker 2 will take care of the details for you: your prototype already has a power management system in place. The onboard LTC®3586-1 IC will provide 3.3V or 5V to the clicks. It turns the USB port into a battery charger. For convenience, clicker 2 for CEC1302 features a reset button and an ON/OFF switch (you can also connect an external ON/OFF switch).

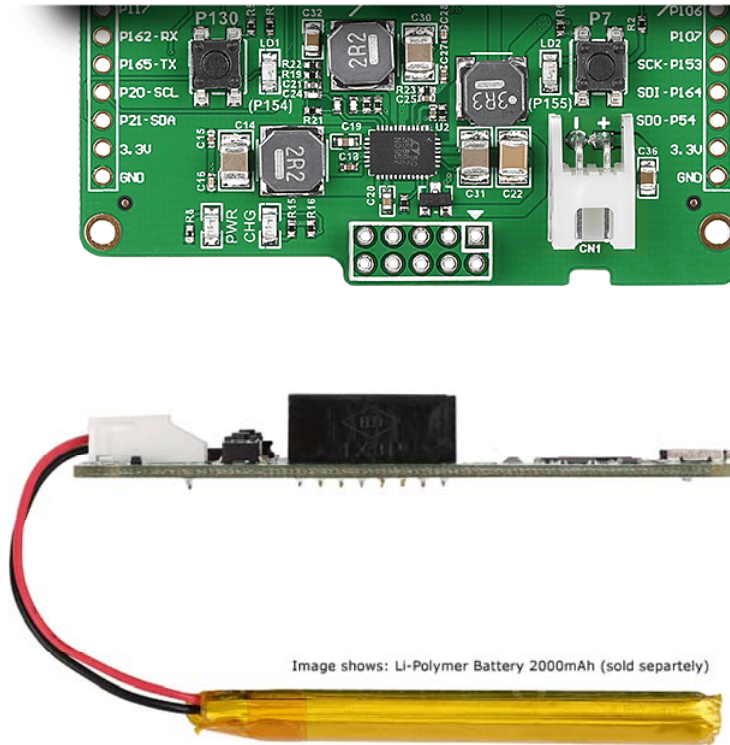

Expanding Your Ideas

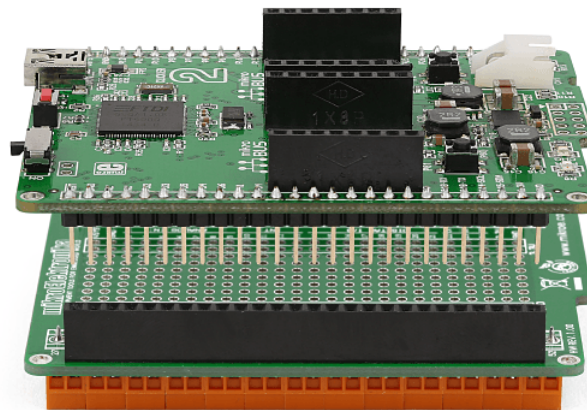

No idea is too big for clicker 2. Let your train of thought lead you anywhere. Consider all options, explore all directions. More click boards? Additional electronics? Done and done. clicker 2 has the same pocket-size form factor and the same pair of 1x26 connection pads as mikromedia boards. This makes it compatible with mikromedia shields letting you expand your device any way you want.

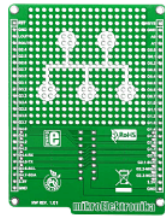

MIKROE-1154
mikroBUS shield

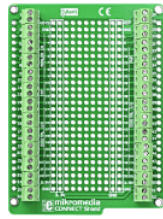

MIKROE-938
Connect shield

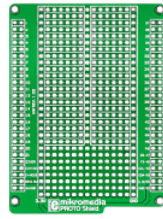

MIKROE-767
PHOTO shield

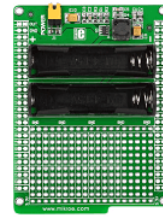

MIKROE-712
Battery Boost shield

Hardware Debugging

Efficiently eradicate any bugs and iron out your code until it's wrinkle free and your clicker 2 device works perfectly—use mikroProg™ for CEC1302. It's a fast hardware debugger and programmer that exploits the MCU's integrated encryption module, enabling secure firmware updating.



Tech specs

Pushbuttons, signal LEDs, jumpers, pads for connecting an external ON/OFF switch, here are all the bits and details at your disposal:

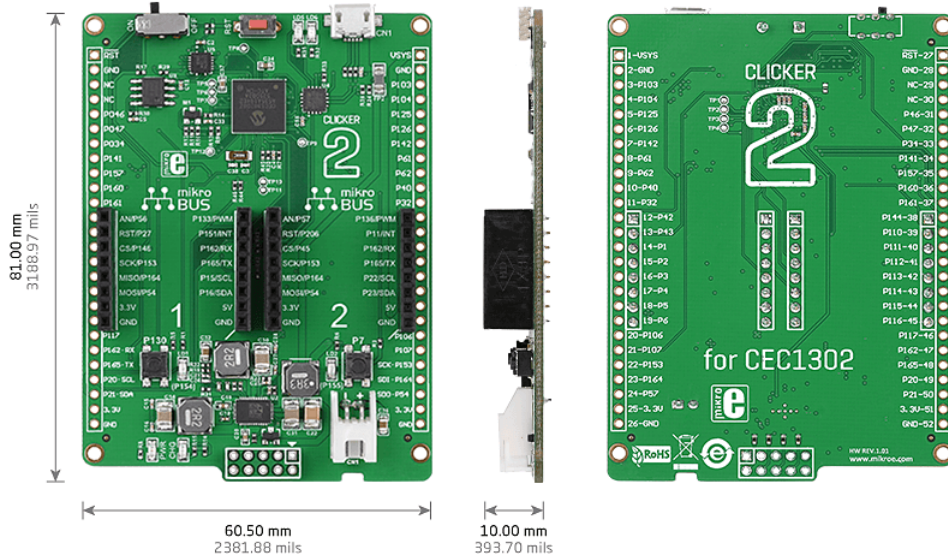

Processor

- CEC1302 has 128 KB SRAM
- 32 KB boot ROM
- 48MHz



Connectivity

- 52 programmable GPIOs
- 2 mikroBUS host sockets
- USB Mini-B connector

Documentation and software



[Download Schematic \[6.43MB\]](#)



[Download UART Bootloader \[1.05MB\]](#)



[Download mikroProg Suite for ARM \[2.3MB\]](#)

What's in the package?

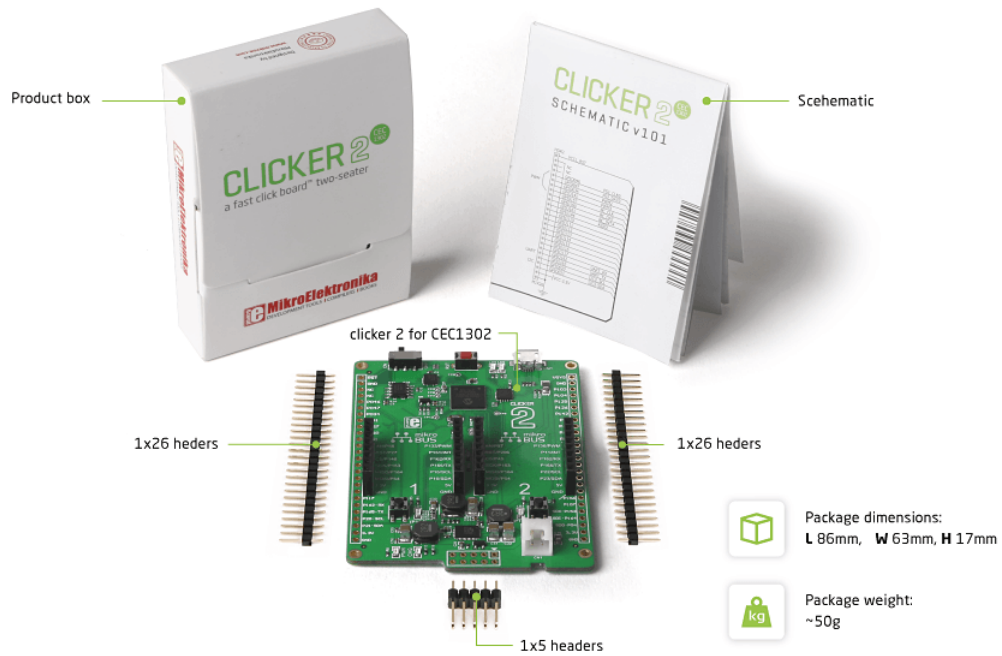

Order Now

MIKROE-1969

clicker 2 for CEC1302