



Chipsmall Limited consists of a professional team with an average of over 10 year of expertise in the distribution of electronic components. Based in Hongkong, we have already established firm and mutual-benefit business relationships with customers from,Europe,America and south Asia,supplying obsolete and hard-to-find components to meet their specific needs.

With the principle of “Quality Parts,Customers Priority,Honest Operation,and Considerate Service”,our business mainly focus on the distribution of electronic components. Line cards we deal with include Microchip,ALPS,ROHM,Xilinx,Pulse,ON,Everlight and Freescale. Main products comprise IC,Modules,Potentiometer,IC Socket,Relay,Connector.Our parts cover such applications as commercial,industrial, and automotives areas.

We are looking forward to setting up business relationship with you and hope to provide you with the best service and solution. Let us make a better world for our industry!



Contact us

Tel: +86-755-8981 8866 Fax: +86-755-8427 6832

Email & Skype: info@chipsmall.com Web: www.chipsmall.com

Address: A1208, Overseas Decoration Building, #122 Zhenhua RD., Futian, Shenzhen, China



MJE3439G

NPN Silicon High-Voltage Power Transistor

This device is designed for use in line-operated equipment requiring high f_T .

Features

- High DC Current Gain
- High Current-Gain – Bandwidth Product
- Low Output Capacitance
- These Devices are Pb-Free and are RoHS Compliant*

MAXIMUM RATINGS

Rating	Symbol	Value	Unit
Collector-Emitter Voltage	V_{CEO}	350	Vdc
Collector-Base Voltage	V_{CB}	450	Vdc
Emitter-Base Voltage	V_{EB}	5.0	Vdc
Collector Current – Continuous	I_C	0.3	Adc
Base Current	I_B	150	mAdc
Total Power Dissipation @ $T_C = 25^\circ\text{C}$ Derate above 25°C	P_D	15 0.12	W mW/ $^\circ\text{C}$
Operating and Storage Junction Temperature Range	T_J, T_{stg}	-65 to +150	$^\circ\text{C}$

Stresses exceeding those listed in the Maximum Ratings table may damage the device. If any of these limits are exceeded, device functionality should not be assumed, damage may occur and reliability may be affected.

THERMAL CHARACTERISTICS

Characteristic	Symbol	Max	Unit
Thermal Resistance, Junction-to-Case	θ_{JC}	8.33	$^\circ\text{C/W}$



ON Semiconductor[®]

<http://onsemi.com>

**0.3 AMPERE
POWER TRANSISTOR
NPN SILICON
350 VOLTS, 15 WATTS**

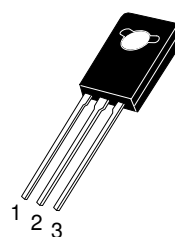
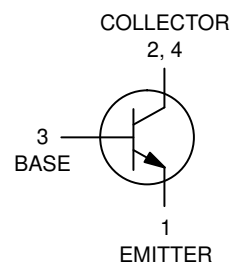

**TO-225
CASE 77-09
STYLE 1**

MARKING DIAGRAM

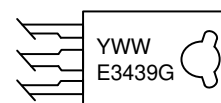

Y = Year
WW = Work Week
E3439 = Device Code
G = Pb-Free Package

ORDERING INFORMATION

Device	Package	Shipping
MJE3439G	TO-225 (Pb-Free)	500 Units/Box

*For additional information on our Pb-Free strategy and soldering details, please download the ON Semiconductor Soldering and Mounting Techniques Reference Manual, SOLDERRM/D.

MJE3439G

ELECTRICAL CHARACTERISTICS ($T_C = 25^\circ\text{C}$ unless otherwise noted)

Characteristic	Symbol	Min	Max	Unit
OFF CHARACTERISTICS				
Collector–Emitter Sustaining Voltage ($I_C = 5.0\text{ mA}$, $I_B = 0$)	$V_{CEO(sus)}$	350	–	Vdc
Collector Cutoff Current ($V_{CE} = 300\text{ Vdc}$, $I_B = 0$)	I_{CEO}	–	20	μA
Collector Cutoff Current ($V_{CE} = 450\text{ Vdc}$, $V_{EB(off)} = 1.5\text{ Vdc}$)	I_{CEX}	–	500	μA
Collector Cutoff Current ($V_{CB} = 350\text{ Vdc}$, $I_E = 0$)	I_{CBO}	–	20	μA
Emitter Cutoff Current ($V_{BE} = 5.0\text{ Vdc}$, $I_C = 0$)	I_{EBO}	–	20	μA
ON CHARACTERISTICS				
DC Current Gain ($I_C = 2.0\text{ mA}$, $V_{CE} = 10\text{ Vdc}$) ($I_C = 20\text{ mA}$, $V_{CE} = 10\text{ Vdc}$)	h_{FE}	30 15	– 200	–
Collector–Emitter Saturation Voltage ($I_C = 50\text{ mA}$, $I_B = 4.0\text{ mA}$)	$V_{CE(sat)}$	–	0.5	Vdc
Base–Emitter Saturation Voltage ($I_C = 50\text{ mA}$, $I_B = 4.0\text{ mA}$)	$V_{BE(sat)}$	–	1.3	Vdc
Base–Emitter On Voltage ($I_C = 50\text{ mA}$, $V_{CE} = 10\text{ Vdc}$)	$V_{BE(on)}$	–	0.8	Vdc
DYNAMIC CHARACTERISTICS				
Current–Gain – Bandwidth Product ($I_C = 10\text{ mA}$, $V_{CE} = 10\text{ Vdc}$, $f = 5.0\text{ MHz}$)	f_T	15	–	MHz
Output Capacitance ($V_{CB} = 10\text{ Vdc}$, $I_E = 0$, $f = 1.0\text{ MHz}$)	C_{ob}	–	10	pF
Small–Signal Current Gain ($I_C = 5.0\text{ mA}$, $V_{CE} = 10\text{ Vdc}$, $f = 1.0\text{ kHz}$)	h_{fe}	25	–	–

Product parametric performance is indicated in the Electrical Characteristics for the listed test conditions, unless otherwise noted. Product performance may not be indicated by the Electrical Characteristics if operated under different conditions.

MJE3439G

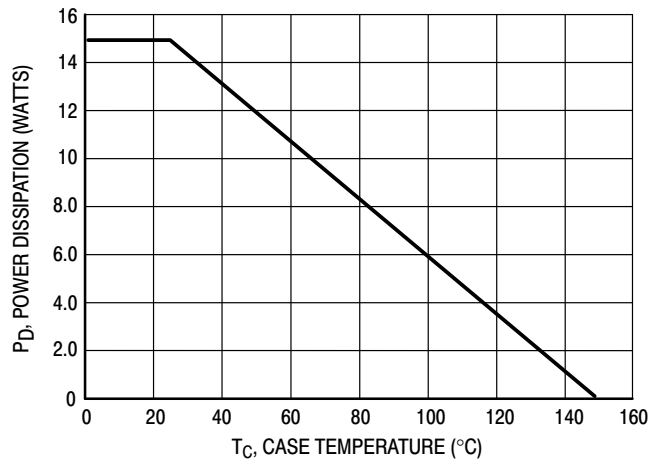

Figure 1. Power-Temperature Derating Curve

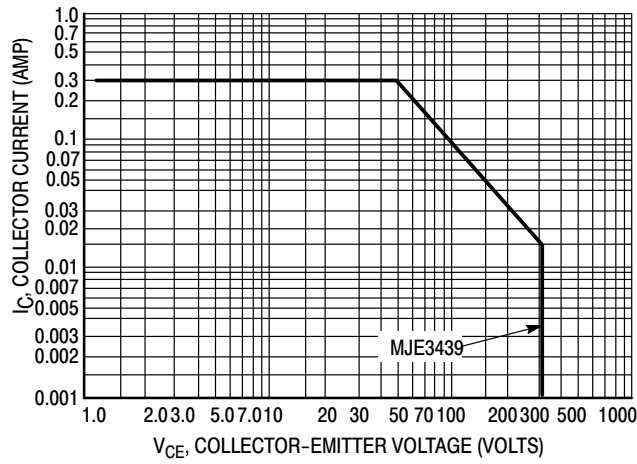

Figure 2. Active-Region Safe Operating Area

The Safe Operating Area Curves indicate $I_C - V_{CE}$ limits below which the device will not enter secondary breakdown. Collector load lines for specific circuits must fall within the applicable Safe Area to avoid causing a catastrophic failure. To insure operation below the maximum T_J , power-temperature derating must be observed for both steady state and pulse power conditions.

MJE3439G

PACKAGE DIMENSIONS

TO-225
CASE 77-09
ISSUE AC

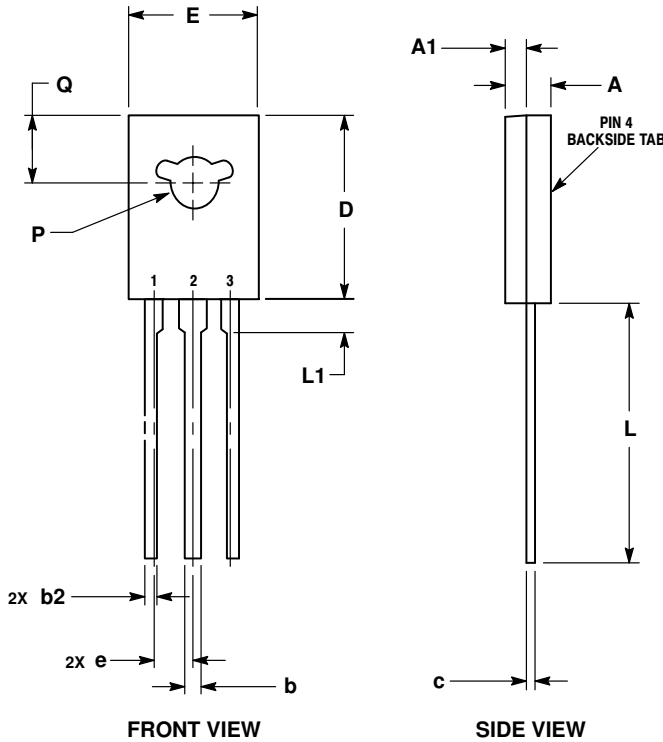
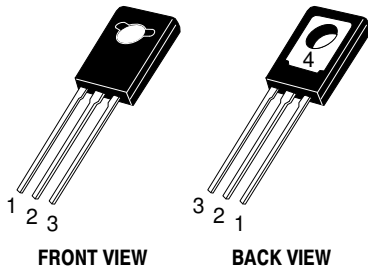

- NOTES:
1. DIMENSIONING AND TOLERANCING PER ASME Y14.5M, 1994.
 2. CONTROLLING DIMENSION: MILLIMETERS.
 3. NUMBER AND SHAPE OF LUGS OPTIONAL.

DIM	MILLIMETERS	
	MIN	MAX
A	2.40	3.00
A1	1.00	1.50
b	0.60	0.90
b2	0.51	0.88
c	0.39	0.63
D	10.60	11.10
E	7.40	7.80
e	2.04	2.54
L	14.50	16.63
L1	1.27	2.54
P	2.90	3.30
Q	3.80	4.20

- STYLE 1:
PIN 1. EMITTER
2., 4. COLLECTOR
3. BASE

ON Semiconductor and  are registered trademarks of Semiconductor Components Industries, LLC (SCILLC). SCILLC owns the rights to a number of patents, trademarks, copyrights, trade secrets, and other intellectual property. A listing of SCILLC's product/patent coverage may be accessed at www.onsemi.com/site/pdf/Patent-Marking.pdf. SCILLC reserves the right to make changes without further notice to any products herein. SCILLC makes no warranty, representation or guarantee regarding the suitability of its products for any particular purpose, nor does SCILLC assume any liability arising out of the application or use of any product or circuit, and specifically disclaims any and all liability, including without limitation special, consequential or incidental damages. "Typical" parameters which may be provided in SCILLC data sheets and/or specifications can and do vary in different applications and actual performance may vary over time. All operating parameters, including "Typicals" must be validated for each customer application by customer's technical experts. SCILLC does not convey any license under its patent rights nor the rights of others. SCILLC products are not designed, intended, or authorized for use as components in systems intended for surgical implant into the body, or other applications intended to support or sustain life, or for any other application in which the failure of the SCILLC product could create a situation where personal injury or death may occur. Should Buyer purchase or use SCILLC products for any such unintended or unauthorized application, Buyer shall indemnify and hold SCILLC and its officers, employees, subsidiaries, affiliates, and distributors harmless against all claims, costs, damages, and expenses, and reasonable attorney fees arising out of, directly or indirectly, any claim of personal injury or death associated with such unintended or unauthorized use, even if such claim alleges that SCILLC was negligent regarding the design or manufacture of the part. SCILLC is an Equal Opportunity/Affirmative Action Employer. This literature is subject to all applicable copyright laws and is not for resale in any manner.

PUBLICATION ORDERING INFORMATION

LITERATURE FULFILLMENT:
Literature Distribution Center for ON Semiconductor
P.O. Box 5163, Denver, Colorado 80217 USA
Phone: 303-675-2175 or 800-344-3860 Toll Free USA/Canada
Fax: 303-675-2176 or 800-344-3867 Toll Free USA/Canada
Email: orderlit@onsemi.com

N. American Technical Support: 800-282-9855 Toll Free
USA/Canada
Europe, Middle East and Africa Technical Support:
Phone: 421 33 790 2910
Japan Customer Focus Center
Phone: 81-3-5817-1050

ON Semiconductor Website: www.onsemi.com
Order Literature: <http://www.onsemi.com/orderlit>
For additional information, please contact your local Sales Representative