



Chipsmall Limited consists of a professional team with an average of over 10 year of expertise in the distribution of electronic components. Based in Hongkong, we have already established firm and mutual-benefit business relationships with customers from,Europe,America and south Asia,supplying obsolete and hard-to-find components to meet their specific needs.

With the principle of "Quality Parts,Customers Priority,Honest Operation,and Considerate Service",our business mainly focus on the distribution of electronic components. Line cards we deal with include Microchip,ALPS,ROHM,Xilinx,Pulse,ON,Everlight and Freescale. Main products comprise IC,Modules,Potentiometer,IC Socket,Relay,Connector.Our parts cover such applications as commercial,industrial, and automotives areas.

We are looking forward to setting up business relationship with you and hope to provide you with the best service and solution. Let us make a better world for our industry!



## Contact us

Tel: +86-755-8981 8866 Fax: +86-755-8427 6832

Email & Skype: info@chipsmall.com Web: www.chipsmall.com

Address: A1208, Overseas Decoration Building, #122 Zhenhua RD., Futian, Shenzhen, China



# MJE700G, MJE702G, MJE703G (PNP), MJE800G, MJE802G, MJE803G (NPN)



ON Semiconductor®

<http://onsemi.com>

## Plastic Darlington Complementary Silicon Power Transistors

These devices are designed for general-purpose amplifier and low-speed switching applications.

### Features

- High DC Current Gain –  $h_{FE} = 2000$  (Typ) @  $I_C = 2.0$  Adc
- Monolithic Construction with Built-in Base-Emitter Resistors to Limit Leakage – Multiplication
- Choice of Packages – MJE700 and MJE800 Series
- These Devices are Pb-Free and are RoHS Compliant\*

### MAXIMUM RATINGS

Rating	Symbol	Value	Unit
Collector-Emitter Voltage MJE700G, MJE800G MJE702G, MJE703G, MJE802G, MJE803G	$V_{CEO}$	60 80	Vdc
Collector-Base Voltage MJE700G, MJE800G MJE702G, MJE703G, MJE802G, MJE803G	$V_{CB}$	60 80	Vdc
Emitter-Base Voltage	$V_{EB}$	5.0	Vdc
Collector Current	$I_C$	4.0	Adc
Base Current	$I_B$	0.1	Adc
Total Power Dissipation @ $T_C = 25^\circ\text{C}$ Derate above $25^\circ\text{C}$	$P_D$	40 0.32	W mW/°C
Operating and Storage Junction Temperature Range	$T_J, T_{stg}$	-55 to +150	°C

Stresses exceeding those listed in the Maximum Ratings table may damage the device. If any of these limits are exceeded, device functionality should not be assumed, damage may occur and reliability may be affected.

### THERMAL CHARACTERISTICS

Characteristic	Symbol	Max	Unit
Thermal Resistance, Junction-to-Case	$R_{\theta JC}$	3.12	°C/W
Thermal Resistance, Junction-to-Ambient	$R_{\theta JA}$	83.3	°C/W

\*For additional information on our Pb-Free strategy and soldering details, please download the ON Semiconductor Soldering and Mounting Techniques Reference Manual, SOLDERRM/D.

## 4.0 AMPERE DARLINGTON POWER TRANSISTORS COMPLEMENTARY SILICON 40 WATT

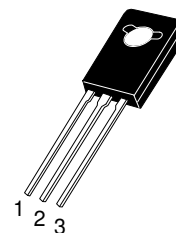
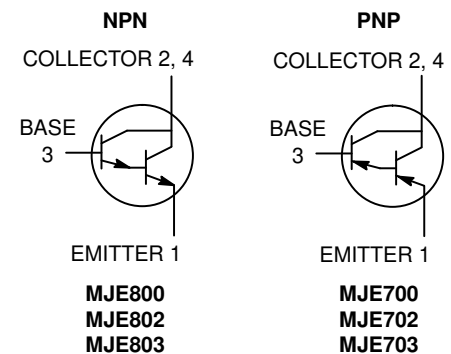

TO-225  
CASE 77-09  
STYLE 1

### MARKING DIAGRAM

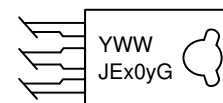

Y = Year  
WW = Work Week  
JEx0y = Device Code  
x = 7 or 8  
y = 0, 2, or 3  
G = Pb-Free Package

### ORDERING INFORMATION

See detailed ordering and shipping information in the package dimensions section on page 5 of this data sheet.

# MJE700G, MJE702G, MJE703G (PNP), MJE800G, MJE802G, MJE803G (NPN)

## ELECTRICAL CHARACTERISTICS (T<sub>C</sub> = 25°C unless otherwise noted)

Characteristic	Symbol	Min	Max	Unit
<b>OFF CHARACTERISTICS</b>				
Collector–Emitter Breakdown Voltage (Note 1) (I <sub>C</sub> = 50 mAdc, I <sub>B</sub> = 0) MJE700G, MJE800G MJE702G, MJE703G, MJE802G, MJE803G	V <sub>(BR)CEO</sub>	60 80	– –	Vdc
Collector Cutoff Current (V <sub>CE</sub> = 60 Vdc, I <sub>B</sub> = 0) MJE700G, MJE800G (V <sub>CE</sub> = 80 Vdc, I <sub>B</sub> = 0) MJE702G, MJE703G, MJE802G, MJE803G	I <sub>CEO</sub>	– –	100 100	μAdc
Collector Cutoff Current (V <sub>CB</sub> = Rated BV <sub>CEO</sub> , I <sub>E</sub> = 0) (V <sub>CB</sub> = Rated BV <sub>CEO</sub> , I <sub>E</sub> = 0, T <sub>C</sub> = 100°C)	I <sub>CBO</sub>	– –	100 500	μAdc
Emitter Cutoff Current (V <sub>BE</sub> = 5.0 Vdc, I <sub>C</sub> = 0)	I <sub>EBO</sub>	–	2.0	mAdc

## ON CHARACTERISTICS

DC Current Gain (Note 1) (I <sub>C</sub> = 1.5 Adc, V <sub>CE</sub> = 3.0 Vdc) MJE700G, MJE702G, MJE800G, MJE802G (I <sub>C</sub> = 2.0 Adc, V <sub>CE</sub> = 3.0 Vdc) MJE703G, MJE803G (I <sub>C</sub> = 4.0 Adc, V <sub>CE</sub> = 3.0 Vdc) All devices	h <sub>FE</sub>	750 750 100	– – –	–
Collector–Emitter Saturation Voltage (Note 1) (I <sub>C</sub> = 1.5 Adc, I <sub>B</sub> = 30 mAdc) MJE700G, MJE702G, MJE800G, MJE802G (I <sub>C</sub> = 2.0 Adc, I <sub>B</sub> = 40 mAdc) MJE703G, MJE803G (I <sub>C</sub> = 4.0 Adc, I <sub>B</sub> = 40 mAdc) All devices	V <sub>CE(sat)</sub>	– – –	2.5 2.8 3.0	Vdc
Base–Emitter On Voltage (Note 1) (I <sub>C</sub> = 1.5 Adc, V <sub>CE</sub> = 3.0 Vdc) MJE700G, MJE702G, MJE800G, MJE802G (I <sub>C</sub> = 2.0 Adc, V <sub>CE</sub> = 3.0 Vdc) MJE703G, MJE803G (I <sub>C</sub> = 4.0 Adc, V <sub>CE</sub> = 3.0 Vdc) All devices	V <sub>BE(on)</sub>	– – –	2.5 2.5 3.0	Vdc

## DYNAMIC CHARACTERISTICS

Small–Signal Current Gain (I <sub>C</sub> = 1.5 Adc, V <sub>CE</sub> = 3.0 Vdc, f = 1.0 MHz)	h <sub>fe</sub>	1.0	–	–
---	-----------------	-----	---	---

Product parametric performance is indicated in the Electrical Characteristics for the listed test conditions, unless otherwise noted. Product performance may not be indicated by the Electrical Characteristics if operated under different conditions.

1. Pulse Test: Pulse Width ≤ 300 μs, Duty Cycle ≤ 2.0%.

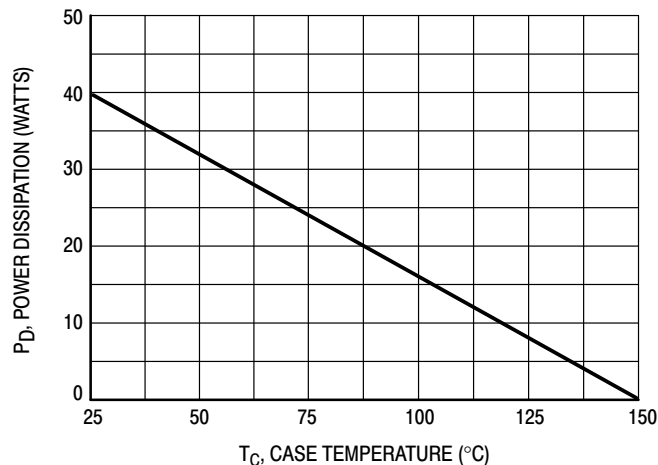

Figure 1. Power Derating

# MJE700G, MJE702G, MJE703G (PNP), MJE800G, MJE802G, MJE803G (NPN)

$R_B$  &  $R_C$  VARIED TO OBTAIN DESIRED CURRENT LEVELS  
 $D_1$ , MUST BE FAST RECOVERY TYPE, e.g.:  
 1N5825 USED ABOVE  $I_B \approx 100$  mA  
 MSD6100 USED BELOW  $I_B \approx 100$  mA

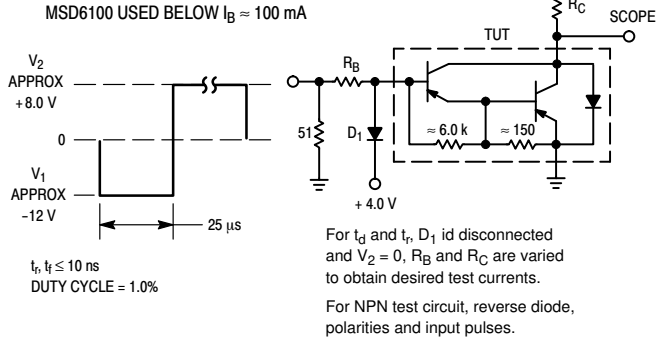

Figure 2. Switching Times Test Circuit

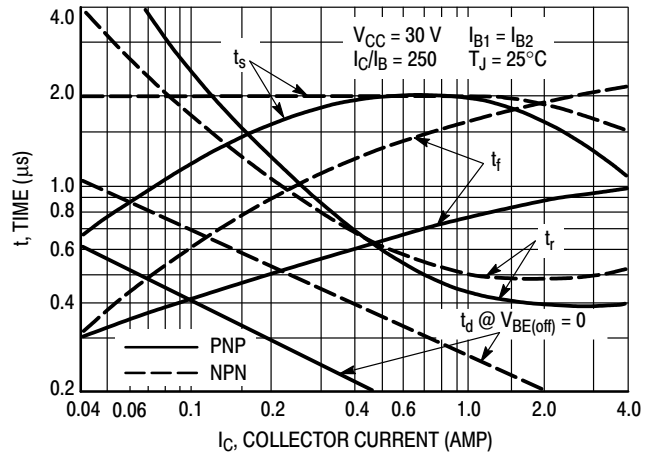

Figure 3. Switching Times

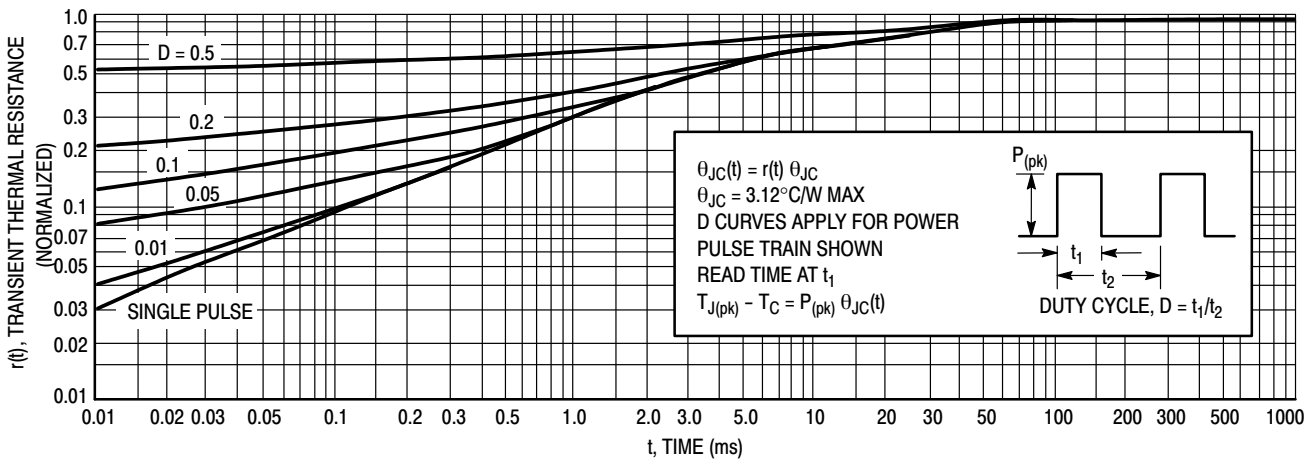

Figure 4. Thermal Response (MJE700, 800 Series)

## ACTIVE-REGION SAFE-OPERATING AREA

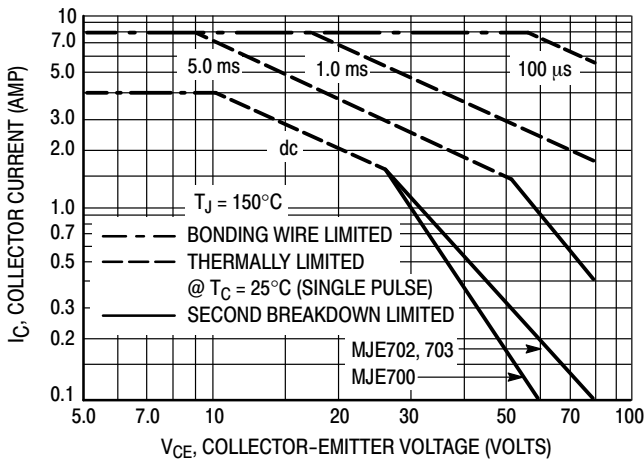

Figure 5. MJE700 Series

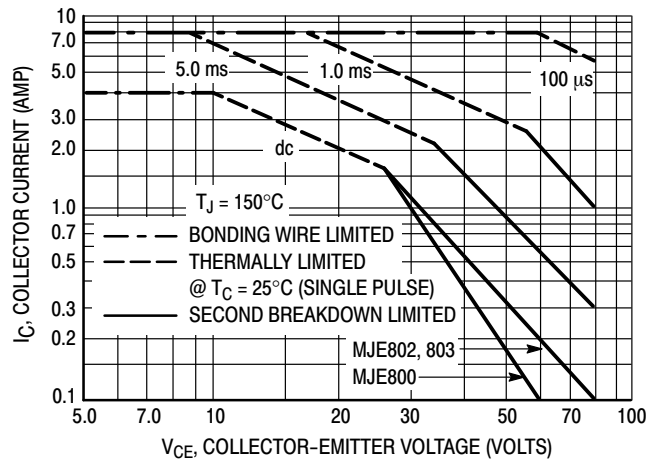

Figure 6. MJE800 Series

There are two limitations on the power handling ability of a transistor: average junction temperature and second breakdown. Safe operating area curves indicate  $I_C - V_{CE}$  limits of the transistor that must be observed for reliable operation; i.e., the transistor must not be subjected to greater dissipation than the curves indicate.

The data of Figures 5 and 6 are based on  $T_{J(pk)} = 150^\circ\text{C}$ ;  $T_C$  is variable depending on conditions. Second breakdown pulse limits are valid for duty cycles to 10% provided  $T_{J(pk)} < 150^\circ\text{C}$ .  $T_{J(pk)}$  may be calculated from the data in Figure 4. At high case temperatures, thermal limitations will reduce the power that can be handled to values less than the limitations imposed by second breakdown.

# MJE700G, MJE702G, MJE703G (PNP), MJE800G, MJE802G, MJE803G (NPN)

**PNP**  
**MJE700 Series**

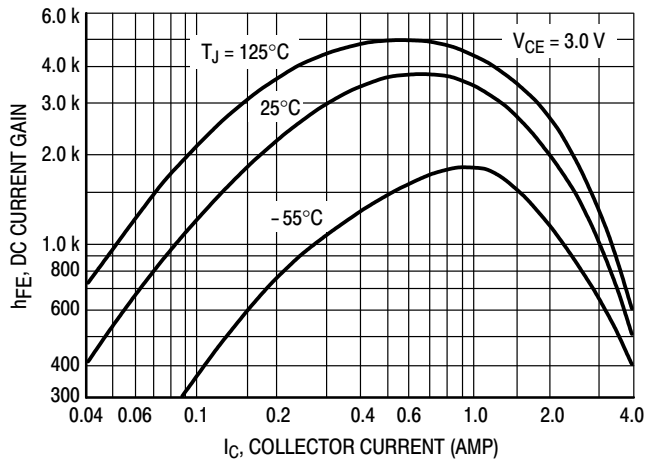

**NPN**  
**MJE800 Series**

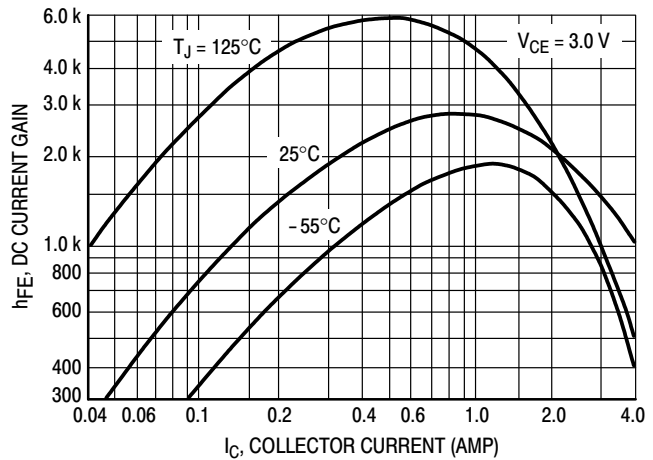

**Figure 7. DC Current Gain**

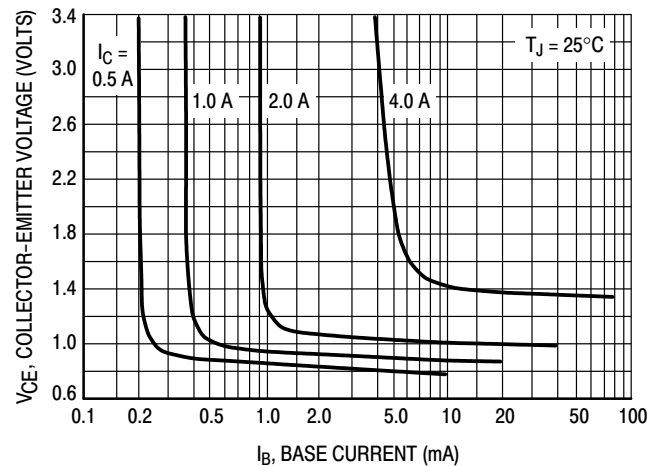
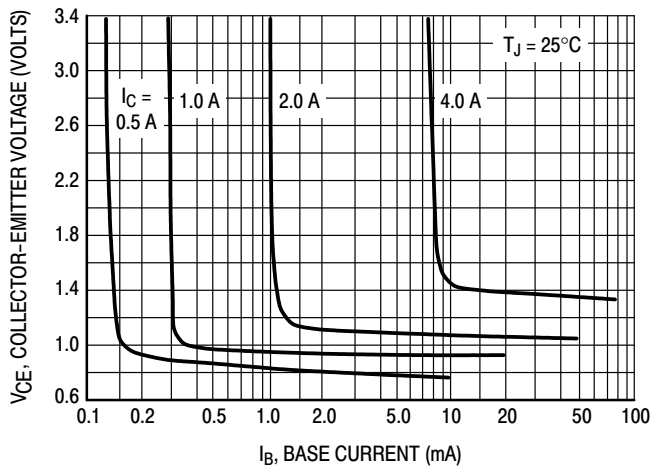

**Figure 8. Collector Saturation Region**

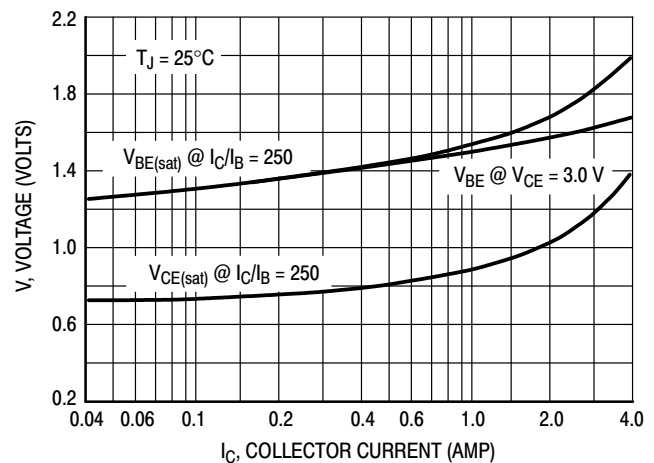
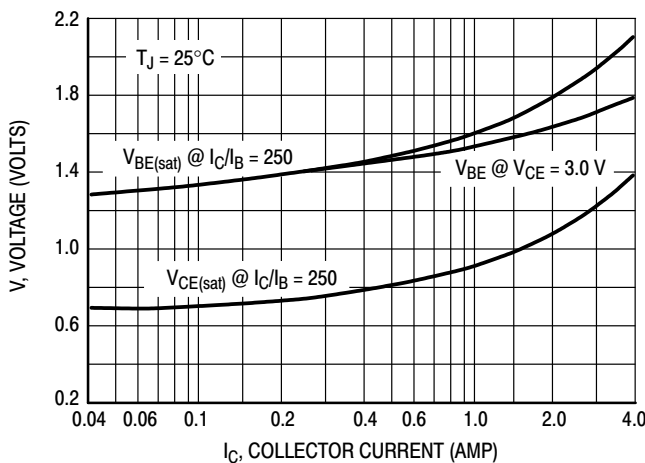

**Figure 9. "On" Voltages**

# MJE700G, MJE702G, MJE703G (PNP), MJE800G, MJE802G, MJE803G (NPN)

## ORDERING INFORMATION

Device	Package	Shipping
MJE700G	TO-225 (Pb-Free)	50 Units / Bulk
MJE702G	TO-225 (Pb-Free)	50 Units / Bulk
MJE703G	TO-225 (Pb-Free)	50 Units / Bulk
MJE800G	TO-225 (Pb-Free)	50 Units / Bulk
MJE802G	TO-225 (Pb-Free)	50 Units / Bulk
MJE803G	TO-225 (Pb-Free)	50 Units / Bulk

# MJE700G, MJE702G, MJE703G (PNP), MJE800G, MJE802G, MJE803G (NPN)

## PACKAGE DIMENSIONS

TO-225  
CASE 77-09  
ISSUE AC

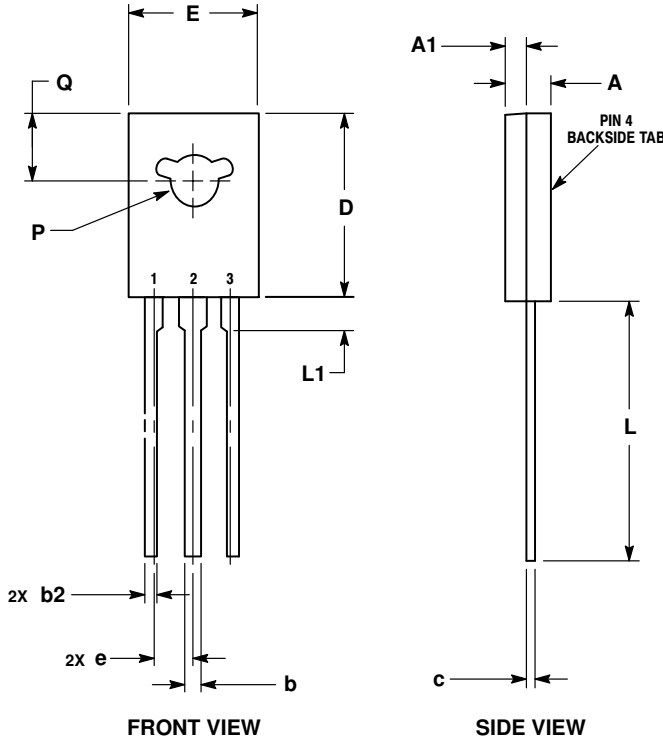
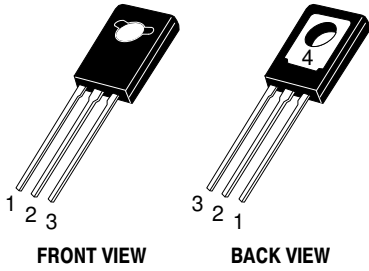

- NOTES:
1. DIMENSIONING AND TOLERANCING PER ASME Y14.5M, 1994.
  2. CONTROLLING DIMENSION: MILLIMETERS.
  3. NUMBER AND SHAPE OF LUGS OPTIONAL.

DIM	MILLIMETERS	
	MIN	MAX
A	2.40	3.00
A1	1.00	1.50
b	0.60	0.90
b2	0.51	0.88
c	0.39	0.63
D	10.60	11.10
E	7.40	7.80
e	2.04	2.54
L	14.50	16.63
L1	1.27	2.54
P	2.90	3.30
Q	3.80	4.20

- STYLE 1:  
PIN 1. EMITTER  
2., 4. COLLECTOR  
3. BASE

ON Semiconductor and are registered trademarks of Semiconductor Components Industries, LLC (SCILLC). SCILLC owns the rights to a number of patents, trademarks, copyrights, trade secrets, and other intellectual property. A listing of SCILLC's product/patent coverage may be accessed at [www.onsemi.com/site/pdf/Patent-Marking.pdf](http://www.onsemi.com/site/pdf/Patent-Marking.pdf). SCILLC reserves the right to make changes without further notice to any products herein. SCILLC makes no warranty, representation or guarantee regarding the suitability of its products for any particular purpose, nor does SCILLC assume any liability arising out of the application or use of any product or circuit, and specifically disclaims any and all liability, including without limitation special, consequential or incidental damages. "Typical" parameters which may be provided in SCILLC data sheets and/or specifications can and do vary in different applications and actual performance may vary over time. All operating parameters, including "Typicals" must be validated for each customer application by customer's technical experts. SCILLC does not convey any license under its patent rights nor the rights of others. SCILLC products are not designed, intended, or authorized for use as components in systems intended for surgical implant into the body, or other applications intended to support or sustain life, or for any other application in which the failure of the SCILLC product could create a situation where personal injury or death may occur. Should Buyer purchase or use SCILLC products for any such unintended or unauthorized application, Buyer shall indemnify and hold SCILLC and its officers, employees, subsidiaries, affiliates, and distributors harmless against all claims, costs, damages, and expenses, and reasonable attorney fees arising out of, directly or indirectly, any claim of personal injury or death associated with such unintended or unauthorized use, even if such claim alleges that SCILLC was negligent regarding the design or manufacture of the part. SCILLC is an Equal Opportunity/Affirmative Action Employer. This literature is subject to all applicable copyright laws and is not for resale in any manner.

### PUBLICATION ORDERING INFORMATION

**LITERATURE FULFILLMENT:**  
Literature Distribution Center for ON Semiconductor  
P.O. Box 5163, Denver, Colorado 80217 USA  
Phone: 303-675-2175 or 800-344-3860 Toll Free USA/Canada  
Fax: 303-675-2176 or 800-344-3867 Toll Free USA/Canada  
Email: [orderlit@onsemi.com](mailto:orderlit@onsemi.com)

**N. American Technical Support:** 800-282-9855 Toll Free  
USA/Canada  
**Europe, Middle East and Africa Technical Support:**  
Phone: 421 33 790 2910  
**Japan Customer Focus Center**  
Phone: 81-3-5817-1050

**ON Semiconductor Website:** [www.onsemi.com](http://www.onsemi.com)  
**Order Literature:** <http://www.onsemi.com/orderlit>  
For additional information, please contact your local Sales Representative